



DIGITAL MULTIMETER
CE
INSTRUCTION MANUAL

APPA 97II





⚠ WARNING

THESE SERVICING INSTRUCTIONS ARE FOR USE BY QUALIFIED PERSONNEL ONLY.
TO AVOID ELECTRIC SHOCK, DO NOT PERFORM ANY SERVICING OTHER THAN THAT
CONTAINED IN THE OPERATING INSTRUCTIONS UNLESS YOU ARE QUALIFIED TO DO SO.





INTRODUCTION

1-1 Unpacking and Inspection

Upon removing your new Digital Multimeter from its packing, you should have the following items:

1. Digital Multimeter.
2. Test lead set (one black, one red).
3. Operators manual.
4. Protective holster.

1-2 Meter Safety

Terms as Marked on Equipment.

 ATTENTION —Refer to manual.

 DOUBLE INSULATION —Protection Class .

 DANGER —Risk of electric shock.





Symbols in this Manual.



 This symbol indicates where cautionary or other information is found in the manual.

 FUSE

 Battery

1-2 Front Panel

Refer to Figure 1 and to the following numbered steps to familiarize yourself with the meter's front panel controls and connectors.

- 1. Digital Display** —The digital display has a 3400 counts LCD readout with 70 segments analog bar graph, auto polarity, decimal point,  AC, DC  RANGE, HOLD APO and unit annunciators.
- 2. Rotary Switch** —Select the Function and Range desired.
- 3. COM Input Terminal** —Ground input connector.
- 4. V Hz Input Terminal** —Positive input connector for Volts, Ohms and Frequency.
- 5. mA Input Terminal** —Positive input connector for Amp measurements (up to 340mA).
- 6. A Input Terminal** —Positive input connector for Amp measurements (up to 10A).





- 7. Range Switch, (Manual Range)** —“Range” switch is pressed to select manual ranging and to change ranges. When “Range” switch is pressed “RANGE” annunciator on the LCD appears. Press “RANGE” switch to select appropriate range to be used. Press “RANGE” switch and hold for 2 seconds to return to Autoranging.
- 8. Blue Switch** —Press the switch to measure AC Voltage / Current or DC Voltage/Current in the Voltage / Current mode, or to measure Resistance or continuity or diode in Ω / 蜂鸣 / 二极管 mode.
- 9. Hold Switch** —This switch is used to hold a measured value for all functions, when pressed the “HOLD” annunciator is displayed. Conversions are made but the display is not updated.
- 10. \sim Hz Switch** —This switch is used to quickly view the frequency during measurement of the AC voltage or current. Press “ \sim Hz” switch so that the LCD is changed to display frequency. Press “ \sim Hz” switch again, the LCD reverts back to display the AC signal amplitude reading. In “ \sim Hz” mode, pressing RANGE switch does not change the frequency range. However the RANGE key switch changes the sensitivity of frequency detection, if the input signal amplitude is less than 1% of full scale reading, the user shall increase the sensitivity. Pressing the Range switch in “ \sim Hz” mode also changes the full scale range of the original voltage or current mode.



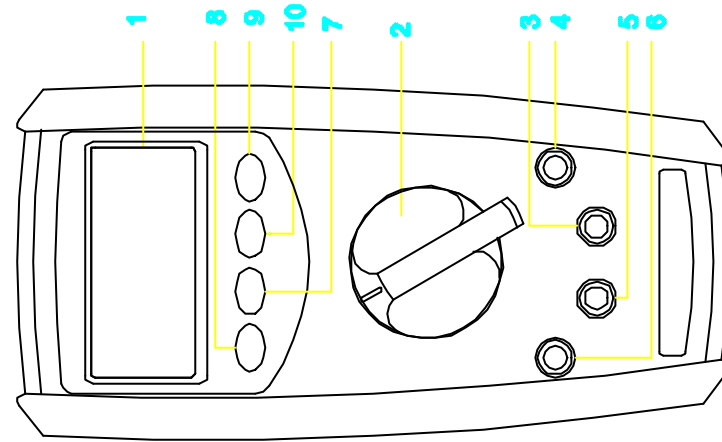

Figure 1





SPECIFICATIONS

2-1 General Specifications

Display : The Liquid Crystal Display (LCD) with a maximum reading of 3400 and 70 segments bar graph.

Polarity Indication : Automatic, positive implied, negative indicated.

Overrange Indication : "OL" or "-OL".

Low Battery Indication : "  " is displayed when the battery voltage drops below operating voltage.

Sampling : 2 times/sec for digit. 12 times/sec for analog bargraph.

Auto Power Off : Approx 10 minutes.

Operating Ambient : 0°C ~ 30°C (80%R.H), 30°C ~ 40°C (75%R.H),
40°C ~ 50°C (45%R.H).

Storage Temperature : -20°C to 60°C , 0 to 80% R.H. when battery removed from meter.

Temperature Coefficient : 0.15 x (Specified accuracy) / °C , <18°C or > 28°C .

Power Requirements : IEC LR03, AM4 or AAA size 1.5V x 2.

Battery Life : Alkaline 500 hours.





Dimensions (W x H x D) : 88mm x 180mm x 33.5mm , without holster.
94mm x 188mm x 40mm , with holster.

Accessories : Protective Holster , batteries (installed), operators manual, test lead set.

2-2 Environmental Conditions

Indoor use.

Maximum Altitude : 2000 Meter.

Installation Category : IEC 1010, 1000V Cat. , 600V Cat. .

Pollution Degree : 2.



2-2 Electrical Specifications

Accuracy is \pm (% reading + number of digits) at 23°C \pm 5°C at less than 80% R.H.

(1) DC Volts

Range	Resolution	Accuracy	Over voltage protection
300mV	100 μ V	\pm (0.25% reading + 1 digit)*	DC 1000V
3V	1mV		
30V	10mV		
300V	100mV		
1000V	1V		

Input Impedance : 10M Ω . (over 1000M Ω in 300mV range).

* \pm (0.4% reading + 1 digit) in 3V range.

(2) AC Volts

Range	Resolution	Accuracy	Over voltage protection
3V	1mV	$\pm(1.3\% \text{ reading} + 5 \text{ digits})^*$	750V rms
30V	10mV	$\pm(1.3\% \text{ reading} + 5 \text{ digits})$ 40Hz to 1KHz	
300V	100mV		
750V	1V		

* **Frequency Response** : 40Hz ~ 500Hz for 3V Range.

AC Conversion Type : Average Sensing rms indication.

Input Impedance : 10M // less than 100PF.

(3) DC Current

Range	Resolution	Accuracy	Voltage Burden
30mA	10 μ A	\pm (1.5% reading + 2 digits)	200mV max
300mA	0.1mA	\pm (1.5% reading + 2 digits)	2V max
10A	10mA	\pm (2.0% reading + 2 digits)	2V max

Overload Protection : 1A (500V) fast blow fuse 10KA breaking capacity @440Vac for mA input.
Size = 32mm x 6.3mm
10A (500V) fast blow fuse 10KA breaking capacity @440Vac for A input.
Size = 32mm x 6.3mm

(4) AC Current

Range	Resolution	Accuracy	Voltage Burden
30mA	10 μ A	$\pm(2.0\%$ reading + 5 digits)	200mV max
300mA	0.1mA		2V max
* 10A	10mA	$\pm(2.5\%$ reading + 5 digits)	2V max

* **Frequency Response** : 40Hz ~ 1KHz.

Overload Protection : 1A (500V) fast blow fuse 10KA breaking capacity @440Vac for mA input.

Size = 32mm x 6.3mm

10A (500V) fast blow fuse 10KA breaking capacity @440Vac for A input.

Size = 32mm x 6.3mm

* **AC Conversion Type** : Average Sensing rms indication.

(5) Resistance

Range	Resolution	Accuracy	Overload Protection
300	0.1	$\pm(1.0\% \text{ reading} + 4 \text{ digits})$	600V rms
3K	1	$\pm(0.7\% \text{ reading} + 3 \text{ digits})$	
30K	10		
300K	100		
3M	1K	$\pm(1.0\% \text{ reading} + 3 \text{ digits})$	
30M	10K	$\pm(2.0\% \text{ reading} + 5 \text{ digits})$	

Open circuit Voltage : -1.5V approx.

(6) Diode Check and Continuity

Range	Resolution	Accuracy	Max. Test Current	Max. Open Circuit Voltage
	1mV	$\pm(1.5\% \text{ reading} + 5 \text{ digits})^*$	1.5mA	3V

* For 0.4V ~ 0.8V.

Overload Protection : 600V rms max.

Continuity : Built-in buzzer sound when resistance is less than 30 Ω approximately.

(7) Frequency / RPM

Range	Resolution	Sensitivity	Accuracy	Overload Protection
3.0KHz/30KRPM	1Hz/30RPM	100mV rms	Frequency : 0.01% ±1 digit RPM : 0.01% ±10 digits	600V rms
30KHz/300KRPM	10Hz/300RPM			
300KHz/3MRPM	100Hz/3KRPM			
3MHz/30MRPM	1KHz/30KRPM			
30MHz/300MRPM	10KHz/300KRPM	250mV rms		

* Less than 20Hz the sensitivity is 1.5V rms.



(8) Auto Power Off (APO)

The APO sign on the LCD panel indicates the meter is working in the Auto Power Off mode. If the meter idles for more than 10 minutes, the meter automatically turns the power off. When this happens, the reading is saved. The meter can be turned back on by pushing any switch or changing the rotary mode. If the meter is repowered like this the LCD displays the saved reading, press the Hold switch to disable the hold state. The meter will give a series of alarm as automatically turns power off by itself 15 seconds before, you can reset the time of Auto-Power-Off by pressing switch or rotates the rotary switch.

(9) Disable Auto Power Off

To disable the auto power off function, press any of the switches (other than HOLD or the BLUE switch) whilst powering the meter up.

(10) ~ Hz sensitivity

The sensitivity in the ~Hz mode is 1/10 of full scale range.

The accuracy is same as Frequency mode. The measuring frequency is from 40Hz up to 1KHz.





OPERATION

This instrument has been designed and tested in accordance with IEC Publication 1010, Safety Requirements for Electronic Measuring Apparatus and has been supplied in a safe condition. This instruction manual contains some Information and warnings which have to be followed by the user to ensure safe operation and to retain the instrument in safe condition.

3-1 Preparation and Caution before Measurement

1. Before measurement, warm up for at least 60 seconds.
2. When the rotary function selector is changed during measurement, be sure do so only after removing the test leads from the equipment.
3. If the equipment is used near noise generating equipment, be aware that may become unstable or indicate large errors.
4.  Maximum rated voltage to earth for voltage and current measurements terminals is 1000V CAT. , 600V CAT. .



3-2 Voltage Measurements

1. Connect the red test lead to the "V Hz" input terminal and the other (black) test lead to the "COM" terminal.
2. Set the rotary function to the V · position.
3. Measurement of AC voltage can be performed by pressing the "BLUE" switch.

 **WARNING**

TO AVOID ELECTRICAL SHOCK, HAZARD OR DAMAGE TO METER, DO NOT A ATTEMPT TO MEASURE VOLTAGES THAT MIGHT EXCEED 1000V ms. DO NOT APPLY MORE THAN 1000V rms BETWEEN THE COMMON INPUT TERMINAL AND EARTH GROUND.

NOTICE

UNSTABLE DISPLAY MAY OCCUR ESPECIALLY AT 300mV RANGE, EVEN THOUGH YOU HAVE NOT PUT TEST LEADS INTO INPUT TERMINALS. IN THIS CASE, IF AN ERRONEOUS READING IS SUSPECTED, SHORT THE "V Hz" TERMINAL AND THE "COM" TERMINAL, AND MAKE SURE THE DISPLAY READS ZERO.



3-3 Current Measurement

1. Connect the red test lead to “mA” terminal and the other (black) test lead to “COM” terminal, or use the “A” and “COM” terminal in the 10A range.
2. Set function selector rotary switch to “mA” or “A” correspondingly.
3. Measurement of AC current can be performed by pushing the “BLUE” switch.
4. Connect the test leads to the circuit to be measured.

3-4 Resistance Measurement

1. Connect the red test lead to the “V Hz” terminal and the other (black) test lead to the “COM” terminal.
2. Set the rotary function selector to “ ” position to measure the resistance.
3. For correct reading, ensure that the device being tested contains no voltage.
4. Connect the test leads across the resistor to be measured. In order to ensure the best accuracy in measurement of low resistance, short the test leads before measurement and note the test probe resistance, then subtract this value from subsequent circuit resistance measurements.





3-5 Continuity Check by Buzzer

1. Connect the red test lead to the “V Hz” terminal and the other (black) test lead to the “COM” terminal.
2. Set the rotary function selector to “” position.
3. Connect the test leads to the circuit to be measured. The buzzer will sound if the resistance of the circuit measured is lower than 30 Ω approximately.

3-6 Diode Check

1. Set the rotary switch at “” position.
2. Connect black test lead to “COM” terminal and red lead to “V Hz” input terminal.
3. Connect test leads to the diode. Normally the forward voltage drop of good silicon diode is shown between 0.400V to 0.900V. If the diode under test is defective, “000” (short circuit) or “OL” (non-conductance) is displayed. During reverse checking the diode is normal if “OL” is displayed, “000” or other values are displayed if it is defective.





3-7 Hz / RPM Measurement

1. Connect the red test lead to the "V Hz" terminal and the other (black) test lead to the "COM" terminal.
2. Set the rotary function selector to "Hz RPM" position to measure the frequency or RPM.
3. Connect the test leads to the circuit to be measured.





MAINTENANCE

⚠ **WARNING** : TO AVOID ELECTRICAL SHOCK REMOVE TEST LEAD BEFORE OPENING THE COVER.

4-1 General Maintenance

1. Repairs or servicing not covered in this manual should only be performed by qualified personal.
2. Periodically wipe the case with a dry cloth and detergent do not use abrasives or solvents.

4-2 Battery Installation or Replacement

The meter is powered by two 1.5V battery. Refer to Figure 2 and use the following procedure to replace the battery:

1. **Disconnect the test leads and turn the meter off.** Remove the test leads from the front terminals.
2. Position the meter face down. Unscrew the self-retaining battery cover screw (i) .
3. Lift the edge of the battery cover gently (ii) until it unsnaps from the meter case.
4. Lift the battery box (iii) from the meter case and remove the 2 x AAA batteries.
5. Fit new batteries into the battery box, observing correct polarity. Place the battery box back into the meter case.
6. Replace the battery cover, making sure that battery leads do not become pinched.



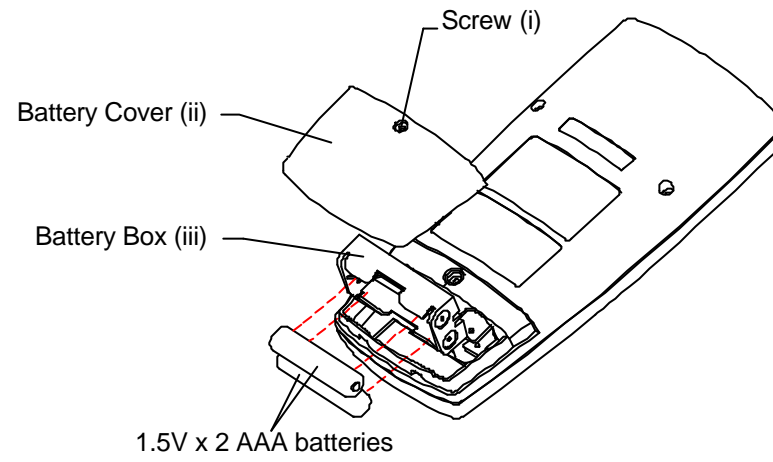

Figure 2





4-3 Fuse Replacement

Refer to Figure 3 and the following procedure to examine or replace the meter's fuse:

1. Perform steps 1 through 3 of the battery replacement procedure.
2. Then remove the two screws from the case bottom and lift the case bottom until it gently unsnaps from the case top.
3. Remove the defective fuse by gently prying one end of the fuse loose and sliding the fuse out of the fuse holder.
4. Install a new fuse of same size and rating. Make sure the new fuse is centered in the fuse holder.
5. Replace the case top and case bottom and battery case bottom. Make sure that the battery leads do not be come pinched between the case halves. Reinstall the three screws.



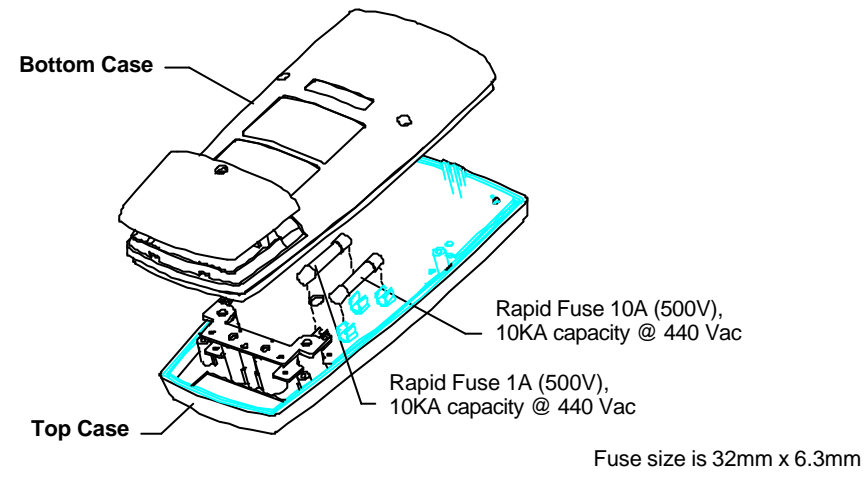
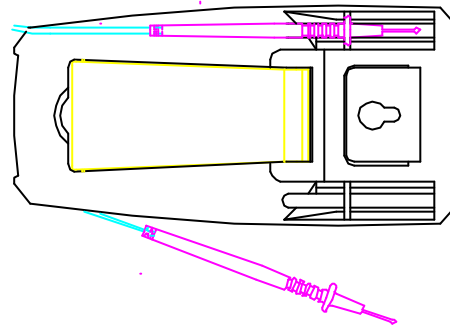

Figure 3





HOW TO USE THE PROBE HOLDER



Clip one probe on the holder for one handed meter operation.

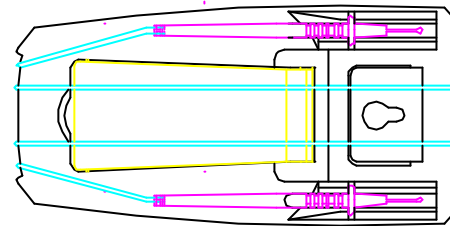

Wrap the leads around the holster to store the test probes.





HOW TO USE THE PROBE HOLDER

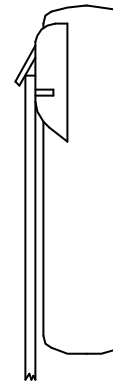
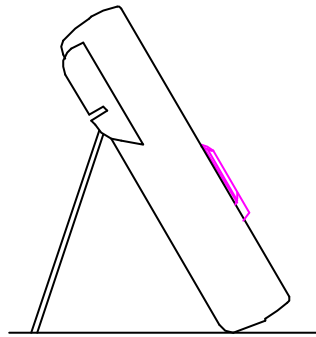

Swing the stand out for easier meter reading.

Swing the upper holder out and hook it over a door.





HOW TO USE THE TILT STAND AND HOLSTER

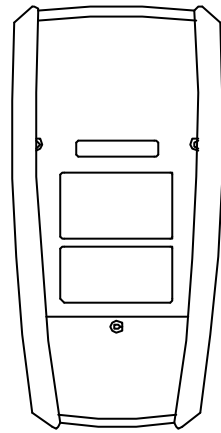

Meter in holster face down.

27

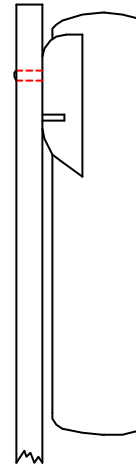

Hang on nail at workbench.





APPA TECHNOLOGY CORP.
9F.119-1 Pao-Zong Rd., Shin-Tien,
Taipai, 23115, Taiwan, R.O.C.
P.O.Box. 12-24 Shin-Tien, Taiwan.
Tel : 886-2-9178820 Fax : 886-2-9170848
E-mail:info @appatech.com
<http://www.appatech.com>

Printed In Taiwan

Copyright © 2003, APPA Tech., Corp. All rights reserved.

