



*Thinking of you*  
**Electrolux**



EGC3313

.....  
**EN HOB**

.....  
**USER MANUAL**



# CONTENTS

1. SAFETY INFORMATION . . . . .	3
2. SAFETY INSTRUCTIONS . . . . .	4
3. PRODUCT DESCRIPTION . . . . .	6
4. DAILY USE . . . . .	6
5. HELPFUL HINTS AND TIPS . . . . .	7
6. CARE AND CLEANING . . . . .	8
7. TROUBLESHOOTING . . . . .	9
8. INSTALLATION . . . . .	10
9. TECHNICAL INFORMATION . . . . .	14

## WE'RE THINKING OF YOU

Thank you for purchasing an Electrolux appliance. You've chosen a product that brings with it decades of professional experience and innovation. Ingenious and stylish, it has been designed with you in mind. So whenever you use it, you can be safe in the knowledge that you'll get great results every time.

Welcome to Electrolux.

### Visit our website for:



Get usage advice, brochures, trouble shooter, service information:  
**[www.electrolux.com](http://www.electrolux.com)**



Register your product for better service:  
**[www.electrolux.com/productregistration](http://www.electrolux.com/productregistration)**



Buy Accessories, Consumables and Original spare parts for your appliance:  
**[www.electrolux.com/shop](http://www.electrolux.com/shop)**

## CUSTOMER CARE AND SERVICE

We recommend the use of original spare parts.

When contacting Service, ensure that you have the following data available.

The information can be found on the rating plate. Model, PNC, Serial Number.



Warning / Caution-Safety information



General information and tips



Environmental information

Subject to change without notice.

# 1. SAFETY INFORMATION

Before the installation and use of the appliance, carefully read the supplied instructions. The manufacturer is not responsible if an incorrect installation and use causes injuries and damages. Always keep the instructions with the appliance for future reference.

## 1.1 Children and vulnerable people safety



### **WARNING!**

Risk of suffocation, injury or permanent disability.

- This appliance can be used by children aged from 8 years and above and persons with reduced physical, sensory or mental capabilities or lack of experience and knowledge if they are supervised by an adult or a person who is responsible for their safety.
- Do not let children play with the appliance.
- Keep all packaging away from children.
- Keep children and pets away from the appliance when it operates or when it cools down. Accessible parts are hot.
- If the appliance has a child safety device, we recommend that you activate it.
- Cleaning and user maintenance shall not be made by children without supervision.

## 1.2 General Safety

- The appliance and its accessible parts become hot during use. Do not touch the heating elements.
- Do not operate the appliance by means of an external timer or separate remote-control system.
- Unattended cooking on a hob with fat or oil can be dangerous and may result in fire.

- Never try to extinguish a fire with water, but switch off the appliance and then cover flame e.g. with a lid or a fire blanket.
- Do not store items on the cooking surfaces.
- Do not use a steam cleaner to clean the appliance.
- Metallic objects such as knives, forks, spoons and lids should not be placed on the hob surface since they can get hot.
- If the glass ceramic surface is cracked, switch off the appliance to avoid the possibility of electric shock.

## 2. SAFETY INSTRUCTIONS

This appliance is suitable for the following markets:  

### 2.1 Installation



#### **WARNING!**

Only a qualified person must install this appliance.

- Remove all the packaging.
- Do not install or use a damaged appliance.
- Obey the installation instruction supplied with the appliance.
- Keep the minimum distance from the other appliances and units.
- Always be careful when you move the appliance because it is heavy. Always wear safety gloves.
- Seal the cut surfaces with a sealant to prevent moisture to cause swelling.
- Protect the bottom of the appliance from steam and moisture.
- Do not install the appliance adjacent to a door or under a window. This prevents hot cookware to fall from the appliance when the door or the window is opened.
- If the appliance is installed above drawers make sure that the space, between the bottom of the appliance and the upper drawer, is sufficient for air circulation.

- The bottom of the appliance can get hot. We recommend to install a non-combustible separation panel under the appliance to prevent access to the bottom.

### Electrical connection



#### **WARNING!**

Risk of fire and electrical shock.

- All electrical connections must be made by a qualified electrician.
- The appliance must be earthed.
- Before carrying out any operation make sure that the appliance is disconnected from the power supply.
- Use the correct electricity mains cable.
- Do not let the electricity mains cable tangle.
- Make sure the mains cable or plug (if applicable) does not touch the hot appliance or hot cookware, when you connect the appliance to the near sockets
- Make sure the appliance is installed correctly. Loose and incorrect electricity mains cable or plug (if applicable) can make the terminal become too hot.
- Make sure that a shock protection is installed.
- Use the strain relief clamp on cable.

- Make sure not to cause damage to the mains plug (if applicable) or to the mains cable. Contact the Service or an electrician to change a damaged mains cable.
- The electrical installation must have an isolation device which lets you disconnect the appliance from the mains at all poles. The isolation device must have a contact opening width of minimum 3 mm.
- Use only correct isolation devices: line protecting cut-outs, fuses (screw type fuses removed from the holder), earth leakage trips and contactors.

## Gas connection

- All gas connections should be made by a qualified person.
- Make sure that there is air circulation around the appliance.
- The information about the gas supply is on the rating plate.
- This appliance is not connected to a device, which evacuates the products of combustion. Make sure to connect the appliance according to current installation regulations. Pay attention to requirements regarding adequate ventilation.

## 2.2 Use



### **WARNING!**

Risk of injury, burns or electric shock.

- Use this appliance in a household environment.
- Do not change the specification of this appliance.
- Do not let the appliance stay unattended during operation.
- Do not operate the appliance with wet hands or when it has contact with water.
- Do not put cutlery or saucepan lids on the cooking zones. They become hot.
- Set the cooking zone to “off” after use.
- Do not use the appliance as a work surface or as a storage surface.
- If the surface of the appliance is cracked, disconnect immediately the

appliance from the power supply. This to prevent an electrical shock.



### **WARNING!**

Risk of fire or explosion.

- Fats and oil when heated can release flammable vapours. Keep flames or heated objects away from fats and oils when you cook with them.
- The vapours that very hot oil releases can cause spontaneous combustion.
- Used oil, that can contain food remnants, can cause fire at a lower temperature than oil used for the first time.
- Do not put flammable products or items that are wet with flammable products in, near or on the appliance.



### **WARNING!**

Risk of damage to the appliance.

- Do not keep hot cookware on the control panel.
- Do not let cookware to boil dry.
- Be careful not to let objects or cookware fall on the appliance. The surface can be damaged.
- Do not activate the cooking zones with empty cookware or without cookware.
- Do not put aluminium foil on the appliance.
- Cookware made of cast iron, aluminium or with a damaged bottom can cause scratches on the glass ceramic. Always lift these objects up when you have to move them on the cooking surface.
- Provide good ventilation in the room where the appliance is installed.
- Make sure that the ventilation openings are not blocked.
- Use only stable cookware with the correct shape and diameter larger than the dimensions of the burners. There is a risk of overheating and rupture of the glass plate (if applicable).
- Make sure the flame does not go out when you quickly turn the knob from the maximum to the minimum position.
- Make sure pots are centrally positioned on the rings and do not stick out over edges of the cooking surface.
- Use only the accessories supplied with the appliance.

- Do not install a flame diffuser on the burner.

### 2.3 Care and Cleaning



**WARNING!**

Risk of damage to the appliance.

- Clean regularly the appliance to prevent the deterioration of the surface material.
- Do not use water spray and steam to clean the appliance.
- Do not clean the burners in the dishwasher.
- Clean the appliance with a moist soft cloth. Only use neutral detergents. Do

not use abrasive products, abrasive cleaning pads, solvents or metal objects.

### 2.4 Disposal



**WARNING!**

Risk of injury or suffocation.

- Contact your municipal authority for information on how to discard the appliance correctly.
- Disconnect the appliance from the mains supply.
- Cut off the mains cable and discard it.
- Flat the external gas pipes.

## 3. PRODUCT DESCRIPTION

### 3.1 Cooking surface layout

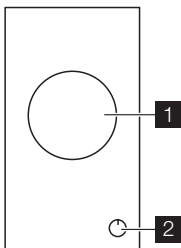

- 1** Triple Crown Burner
- 2** Control knob

### 3.2 Control knobs

Symbol	Description
	no gas supply / off position
	ignition position / maximum gas supply

Symbol	Description
	minimum gas supply

## 4. DAILY USE



**WARNING!**

Refer to the Safety chapters.

## 4.1 Ignition of the burner





### WARNING!

Be very careful when you use open fire in kitchen environment. Manufacturer decline any responsibility in case misuse of the flame



Always light the burner before you put cookware.

To light the burner:

1. Turn the control knob counterclockwise to the maximum position (   ) and push it down.
2. Keep the control knob pushed for approximately 5 seconds; this will let thermocouple to warm up. If not, the gas supply will be interrupted.
3. Adjust the flame after it is regular.



If after some tries the burner does not light, check if the crown and its cap are in correct positions.

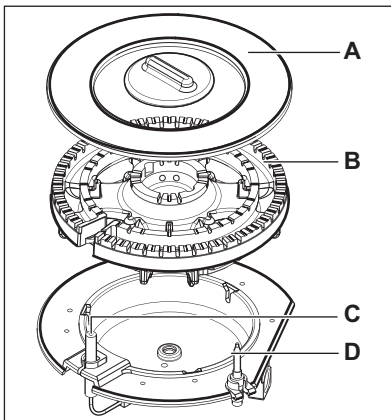

- A) Burner cap
- B) Burner crown
- C) Ignition candle
- D) Thermocouple



### WARNING!

Do not keep the control knob pushed for more than 15 seconds.

If the burner does not light after 15 seconds, release the control knob, turn it into off position and try to light the burner again after minimum 1 minute.



In the absence of electricity you can ignite the burner without electrical device; in this case approach the burner with a flame, push the relevant knob down and turn it counter-clockwise to maximum gas release position.



If the burner accidentally goes out, turn the control knob to the off position and try to light the burner again after minimum 1 minute.



The spark generator can start automatically when you switch on the mains, after installation or a power cut. It is normal.

## 4.2 Turning the burner off

To put the flame out, turn the knob to the symbol  .



### WARNING!

Always turn the flame down or switch it off before you remove the pans from the burner.

## 5. HELPFUL HINTS AND TIPS



### WARNING!

Refer to the Safety chapters.

### 5.1 Energy savings

- If possible, always put the lids on the pans.

- When the liquid starts to boil, turn down the flame to barely simmer the liquid. Use cookware with diameters applicable to the size of burners.

Burner	Diameters of cookware
Triple Crown	160 - 240 mm

**WARNING!**

Do not use cast iron pans, pot-stones, grill or toaster plates on gas burners.

**WARNING!**

Make sure that the handles of the cookware do not extend past the front edge of the hob. Also you must put cookware directly in the centre of the rings in order for the cookware to be fully stable and lower gas consumption.

To prevent injury and from spilling, do not put cookware that is deformed or not stable onto the rings.

**WARNING!**

Liquids spilt during cooking can cause the glass to break

## 6. CARE AND CLEANING

**WARNING!**

Refer to the Safety chapters.

**WARNING!**

Deactivate the appliance and let it cool down before you clean it. Disconnect the appliance from the electrical supply before you do cleaning or maintenance work.



Scratches or dark stains on the surface have no effect on how the appliance operates.

- You can remove the pan supports to easily clean the hob.
- To clean the enamelled parts, cap and crown, wash them with warm soapy water and dry them carefully before you put them back.
- Wash stainless steel parts with water, and then dry them with a soft cloth.
- The pan supports **are not** dishwasher proof. They must be washed **by hand**.
- When you wash the pan supports by hand, take care when you dry them as the enamelling process occasionally leaves rough edges. If necessary, remove stubborn stains using a paste cleaner.
- Make sure you position the pan supports correctly after cleaning.
- To make the burners work correctly, make sure that the arms of the pan supports are in the centre of the burner.

- **Be very careful when you replace the pan supports to prevent the hob top from damage.**

After cleaning, dry the appliance with a soft cloth.

**Removing the dirt:**

1. – **Remove immediately:** melting plastic, plastic foil, and food containing sugar.
  - **Stop the appliance and let it cool down** before you clean: lime-scale rings, water rings, fat stains, shiny metallic discolorations. Use a special cleaner applicable for surface of hob.
2. Clean the appliance with a damp cloth and some detergent.
3. **At the end rub the appliance dry with a clean cloth.**

**WARNING!**

Do not use knives, scrapers or similar instruments to clean the surface of the glass or between the rims of the burners and the frame (if applicable).

**WARNING!**

Do not slide cookware over the glass because it could scratch the surface. Also, do not let hard or sharp objects fall onto the glass or hit the edge of the hob.



### 6.1 Cleaning of the spark plug

This feature is obtained through a ceramic ignition candle with a metal electrode. Keep these components well clean to prevent difficult lighting and check that the burner crown holes are not obstructed.

### 6.2 Periodic maintenance

Periodically speak your local Service Force Centre to check the conditions of the gas supply pipe and the pressure adjuster, if fitted.

## 7. TROUBLESHOOTING

Problem	Possible cause	Remedy
There is no spark when lighting the gas	<ul style="list-style-type: none"> <li>There is no electrical supply</li> </ul>	<ul style="list-style-type: none"> <li>Make sure that the unit is connected and the electrical supply is switched on.</li> <li>Control the fuse. If the fuse is released more than one time, refer to a qualified electrician.</li> </ul>
	<ul style="list-style-type: none"> <li>Burner cap and crown are placed uneven</li> </ul>	<ul style="list-style-type: none"> <li>Make sure that the burner cap and crown are in correct positions.</li> </ul>
The flame is blow out immediately after ignition	<ul style="list-style-type: none"> <li>Thermocouple is not heated sufficient</li> </ul>	<ul style="list-style-type: none"> <li>After lightning the flame, keep the knob pushed for approximately 5 seconds.</li> </ul>
The gas ring burns unevenly	<ul style="list-style-type: none"> <li>Burner crown is blocked with food residues</li> </ul>	<ul style="list-style-type: none"> <li>Make sure that the injector is not blocked and the burner crown is clear of food particles.</li> </ul>

If there is a fault, first try to find a solution to the problem yourself. If you cannot find a solution to the problem yourself, speak your dealer or the local Service Force Centre.



If you operated the appliance incorrectly, or the installation was not carried out by a registered engineer, the visit from the customer service technician or dealer may not take place free of charge, even during the warranty period.

- Product number (PNC) .....
  - Serial Number (S.N.) .....
- Use the original spare parts only. They are available at Service Force Centre and approved spare parts shops.

### 7.1 Labels supplied with the accessories bag

Stick the adhesive labels as indicated below:

**These data are necessary to help you quickly and correctly. These data are available on the supplied rating plate.**

- Model description .....

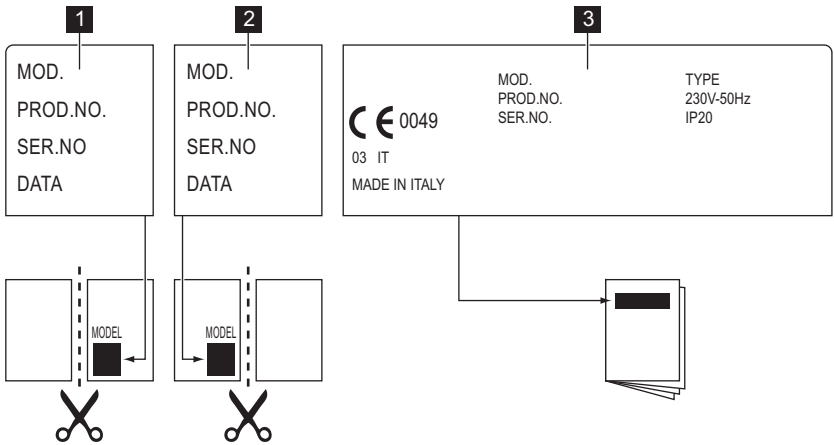

- 1** Stick it on Guarantee Card and send this part
- 2** Stick it on Guarantee Card and keep this part

- 3** Stick it on instruction booklet

## 8. INSTALLATION



**WARNING!**  
Refer to the Safety chapters.



**WARNING!**  
The following instructions about installation, connection and maintenance must be carried out by qualified personnel in compliance with standards and local regulations in force.

### 8.1 Important safety requirements

This hob must be installed in accordance with the Gas Safety (Installation and Use) Regulations (Current Edition) and the IEE Wiring Regulations (Current Edition). For appliances installed in the Republic of Ireland please refer to NSAI- Domestic Gas Installation I.S. 813 Current Editions and the ETCI Rules for Electrical Installations.

#### Provision for ventilation

Detailed recommendations are contained in the following British Standards Codes

Of Practice: B.S. 6172/ B.S. 5440, Par. 2 and B.S. 6891 Current Editions. The hob should not be installed in a bed sitting room with a volume of less than 20 m<sup>3</sup>. If it is installed in a room of volume less than 5 m<sup>3</sup> an air vent of effective area of 100 cm<sup>2</sup> is required. If it is installed in a room of volume between 5 m<sup>3</sup> and 10 m<sup>3</sup> an air vent of effective area of 50 cm<sup>2</sup> is required, while if the volume exceeds 11 m<sup>3</sup> no air vent is required.

However, if the room has a door which opens directly to the outside no air vent is required even if the volume is between 5 m<sup>3</sup> and 11 m<sup>3</sup>.

If there are other fuel burning appliances in the same room, B.S. 5440 Part 2 Current Edition, should be consulted to determine the requisite air vent requirements. For appliances installed in the Republic of Ireland please refer to the NSAI- Domestic Gas Installation I.S. 813 Current Editions Table Four.

#### Location

The hob may be located in a kitchen, a kitchen/diner or bed sitting room (with a

volume greater than 20 m<sup>3</sup>), but not in a bathroom or shower room.

The minimum distance combustible material can be fitted above the hob in line with the edges of the hob is 400 mm. If it is fitted below 400 mm a space of 50 mm must be allowed from the edges of the hob.

For appliances installed in the Republic of Ireland please refer to NSAI- Domestic Gas Installation I.S 813 Current Edition Section 7- Permitted Locations of Appliance.

## 8.2 Gas Connection



### WARNING!

Any gas installation must be carried out by a GAS SAFE REGISTERED installer.

Make sure that, once the hob is installed, it is easily accessible for the engineer in the event of a breakdown.

The manufacturer will not accept liability, should the above instructions or any of the other safety instructions incorporated in this instruction booklet be ignored. Screw the parts and tighten everything with teflon tape, if necessary, to get the right direction.

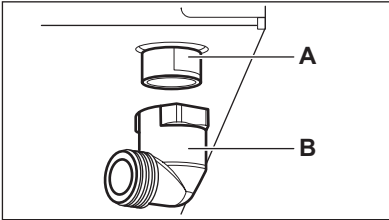

**A)** End of shaft with nut

**B)** Elbow

Connection to the gas supply should be with either rigid or semi-rigid pipe, i.e. steel or copper.

The connection should be suitable for connecting to R 1/2 (1/2 BSP male thread).

When the final connection has been made, it is essential that a thorough leak test is carried out on the hob and installation.

Make sure that the main connection pipe does not exert any strain on the hob. If you use flexible metal pipes make sure that they agree to ISO 10380 and ISO 10807 standards. Be careful they do not

come in touch with mobile parts or they are not squeezed. Also be careful when the hob is put together with an oven.



It is important to install the elbow correctly, with the shoulder on the end of the thread, fitted to the hob connecting pipe.



Failure to ensure the correct assembly will cause leakage of gas.



Make sure that the gas supply pressure of the appliance obeys the recommended values.

### Rigid connection:

Carry out connection by using metal rigid pipes (copper with mechanical end).

## 8.3 Injectors replacement

1. Remove the pan supports.
2. Remove the caps and crowns of the burner.
3. With a socket spanner 7 remove the injectors and replace them with the ones which are necessary for the type of gas you use (see table in "Technical Information" chapter).
4. Assemble the parts, follow the same procedure backwards.
5. Replace the rating plate (it is near the gas supply pipe) with the one for the new type of gas supply. You can find this plate in the package supplied with the appliance.

If the supply gas pressure is changeable or different from the necessary pressure, you must fit an applicable pressure adjuster on the gas supply pipe.

## 8.4 Adjustment of minimum level

To adjust the minimum level of the burners:

1. Light the burner.
2. Turn the knob on the minimum position.
3. Remove the knob.
4. With a thin screwdriver, adjust the bypass screw position.

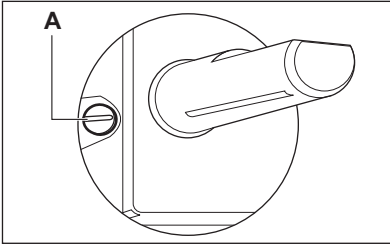

**A)** The by-pass screw

- If you change from natural gas G20 20 mbar to liquid gas, fully tighten the adjustment screw in.
- If you change from liquid gas to natural gas G20 20 mbar, undo the by-pass screw approximately 1/4 of a turn.



**WARNING!**

Make sure the flame does not go out when you quickly turn the knob from the maximum position to the minimum position.

## 8.5 Electrical connection

- Do not pull the mains cable to disconnect the appliance. Always pull the mains plug (if applicable).
- The appliance must not be connected with an extension cable, an adapter or a multiple socket. There is a risk of fire.
- Do not let the power cable to heat up to a temperature of more than 90° C. The cable should be guided by means of clamps fixed to the side of the cabinet, in order to avoid any contact with the equipment beneath the cooktop.
- Make sure that there is access to the mains plug after the installation.

## Electrical Requirements

Permanent electrical installation must agree with the latest I.E.E. Regulations and local Electricity Board regulations. For your own safety the installation must be done by a qualified electrician (e.g. your local Electricity Board, or a contractor who is on the roll of the National Inspection Council for Electrical Installation Contracting [NICEIC]).



The manufacturer refuses to be held responsible, if these safety measures are not abided by.

## Supply connections:

This hob has to be connected to 230 — 240 V ( 50 Hz) electricity supply. Before carrying out the connection, make sure:

1. The limiter valve and the electrical system can take the appliance load (see the rating plate)
2. The supply system is equipped with an efficient earth connection in compliance with the current standards and regulations
3. The outlet or omnipolar switch used for connection is easily accessible with the appliance installed.

The appliance is supplied with a 3 core flexible power cable requiring a 13 amp plug fitted with a 13 amp or 3 amp fuse dependent on the load. You must purchase and install the plug. The wires in the cord are coloured as follows:

Green and yellow	- Earth
Blue	- Neutral
Brown	- Live

## Replacement of the connection cable

1. Connect the green and yellow (earth) wire to the terminal which is marked with the letter 'E', or the earth symbol , or coloured green and yellow.
2. Connect the blue (neutral) wire to the terminal which is marked with the letter 'N' or coloured blue.
3. Connect the brown (live) wire to the terminal which is marked with the letter 'L' and is always connected to the network phase.

There must be no cut or stray strands of wire present. The cord clamp must be correctly attached to the outer sheath.



To replace the connection cable use only H05V2V2-F T90 or equivalent type. Make sure that the cable section is applicable to the voltage load and the working temperature. The yellow/green earth wire (B) must be approximately 2 cm longer than the live and neutral wire (A).

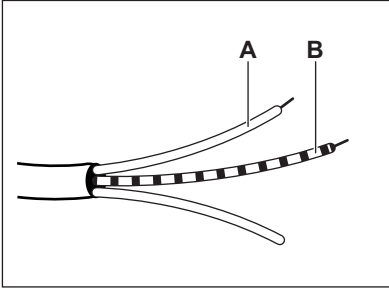

**WARNING!**

A cut off plug inserted into a 13 amp socket is a serious safety (shock) hazard. Ensure that the cut off plug is disposed of safely.



The replacement of electric cable must be carried out exclusively by the service force centre or by personnel with similar competencies, in accordance with the current regulations.

**8.6 Replacement of the connection cable**

To replace the connection cable use only H05V2V2-F T90 or equivalent type. Make sure that the cable section is applicable to the voltage and the working temperature. The yellow/green earth wire must be approximately 2 cm longer than the brown (or black) phase wire.

**8.7 Building in**

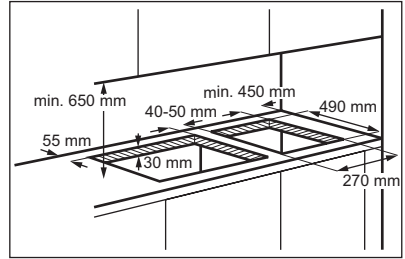

If several 30 cm hobs are to be installed side by side into the same cut out, an assembly kit including a support side bracket and supplementary seals is available at our Service Centres. The relevant installation instructions are supplied within the kit package.

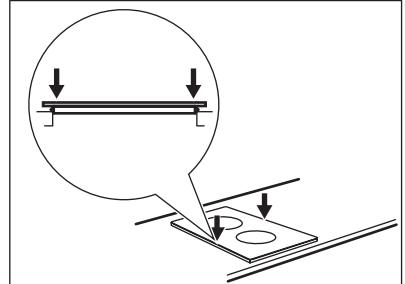
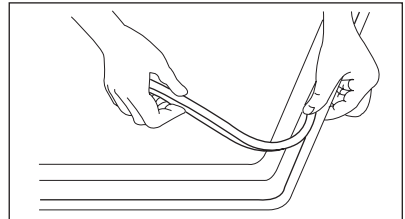
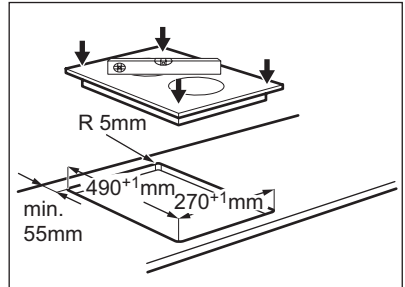

**CAUTION!**

Install the appliance only on a worktop with flat surface.

## 8.8 Possibilities for insertion

### Kitchen unit with door

The panel installed below the hob must be easy to remove and let an easy access in case a technical assistance intervention is necessary.

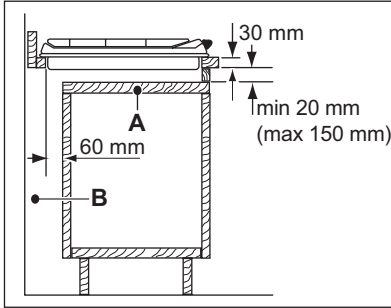

- A) Removable panel
- B) Space for connections

### Kitchen unit with oven

The hob recess dimensions must obey the indication and the kitchen unit must be equipped with vents to let a continuous supply of air. The electrical connection of the hob and the oven must be installed separately for safety reasons and to let easy remove oven from the unit.

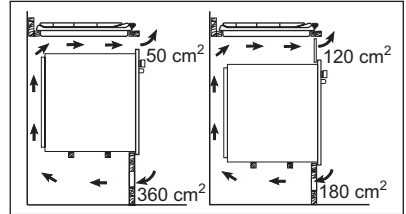

## 9. TECHNICAL INFORMATION

### Hob dimensions

Width:	290 mm
Length:	520 mm

### Hob recess dimensions

Width:	270 mm 0/+1
Length:	490 mm 0/+1

### Heat input

Triple Crown burner:	3.8 kW
TOTAL POWER:	G20 (2H) 20 mbar = 3.8 kW G30 (3+) 28-30 mbar = 276 g/h G31 (3+) 37 mbar = 271 g/h

Electric supply:	230 V ~ 50 Hz 3 core flexible cable with non re-wireable plug fitted with a 3 amp cartridge fuse
------------------	---

Gas connection:	R 1/2"
-----------------	--------

Category:	II2H3+
-----------	--------

Gas supply:	G20 (2H) 20 mbar
-------------	------------------

Appliance class:	3
------------------	---

### By-pass diameters

Burner	Ø By-pass in 1/100 mm.
Triple Crown	56

## Gas burners

BURNER	NOR- MAL POWER	RE- DUC- ED POW- ER	NORMAL POWER				
			NATURAL GAS G20 (2H) 20 mbar		LPG (Butane/Propane) G30/G31 (3+) 28- 30/37 mbar		
			kW	kW	inj. 1/100 mm	m <sup>3</sup> /h	inj. 1/100 mm
					G30 28- 30 mbar	G31 37 mbar	
Triple Crown	3.8	1.4	146	0.362	98	276	271

## 10. ENVIRONMENT CONCERNS

Recycle the materials with the symbol . Put the packaging in applicable containers to recycle it. Help protect the environment and human health and to recycle waste of electrical

and electronic appliances. Do not dispose appliances marked with the symbol  with the household waste. Return the product to your local recycling facility or contact your municipal office.

[www.electrolux.com/shop](http://www.electrolux.com/shop)



397266303-A-452012