

BUNN[®]

Single Multi- BrewWISE[®] DBC[®]

WITH SMART FUNNEL[®]

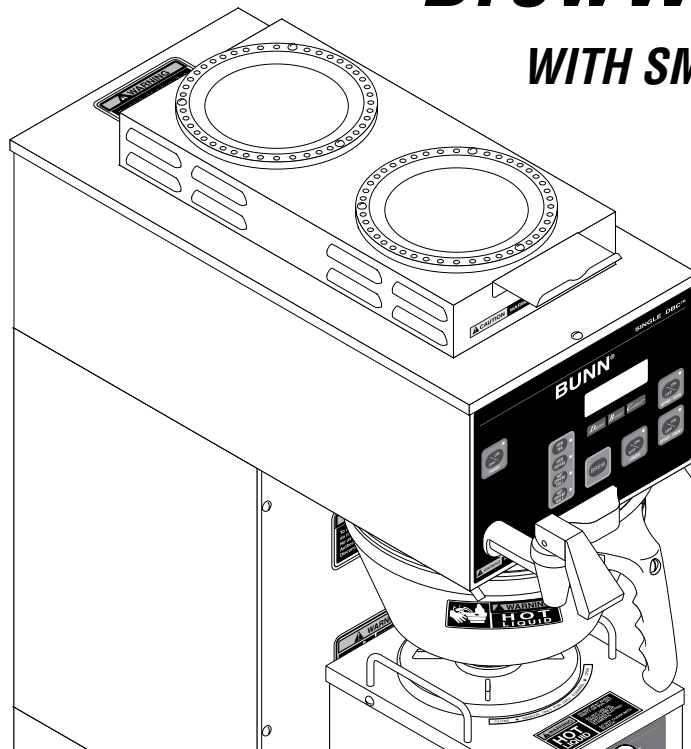

DISCONTINUED VERSION
The information in this manual
is no longer current.



INSTALLATION & OPERATING MANUAL

BUNN-O-MATIC CORPORATION

POST OFFICE BOX 3227

SPRINGFIELD, ILLINOIS 62708-3227

PHONE: (217) 529-6601 FAX: (217) 529-6644

To ensure you have the latest revision of the manual or to obtain the illustrated parts catalog, please visit the Bunn-O-Matic website, at www.bunn.com. This is absolutely FREE, and the quickest way to obtain the latest catalog and manual updates. Contact Bunn-O-Matic Corporation at 1-800-286-6070 to obtain a paper copy of the required Illustrated Parts Catalog mailed via U.S. Postal Service.

BUNN-O-MATIC COMMERCIAL PRODUCT WARRANTY

Bunn-O-Matic Corp. ("BUNN") warrants equipment manufactured by it as follows:

- 1) All equipment other than as specified below: 2 years parts and 1 year labor.
- 2) Electronic circuit and/or control boards: parts and labor for 3 years.
- 3) Compressors on refrigeration equipment: 5 years parts and 1 year labor.
- 4) Grinding burrs on coffee grinding equipment to grind coffee to meet original factory screen sieve analysis: parts and labor for 3 years or 30,000 pounds of coffee, whichever comes first.

These warranty periods run from the date of installation BUNN warrants that the equipment manufactured by it will be commercially free of defects in material and workmanship existing at the time of manufacture and appearing within the applicable warranty period. This warranty does not apply to any equipment, component or part that was not manufactured by BUNN or that, in BUNN's judgment, has been affected by misuse, neglect, alteration, improper installation or operation, improper maintenance or repair, damage or casualty. This warranty is conditioned on the Buyer 1) giving BUNN prompt notice of any claim to be made under this warranty by telephone at (217) 529-6601 or by writing to Post Office Box 3227, Springfield, Illinois 62708-3227; 2) if requested by BUNN, shipping the defective equipment prepaid to an authorized BUNN service location; and 3) receiving prior authorization from BUNN that the defective equipment is under warranty.

THE FOREGOING WARRANTY IS EXCLUSIVE AND IS IN LIEU OF ANY OTHER WARRANTY, WRITTEN OR ORAL, EXPRESS OR IMPLIED, INCLUDING, BUT NOT LIMITED TO, ANY IMPLIED WARRANTY OF EITHER MERCHANTABILITY OR FITNESS FOR A PARTICULAR PURPOSE. The agents, dealers or employees of BUNN are not authorized to make modifications to this warranty or to make additional warranties that are binding on BUNN. Accordingly, statements by such individuals, whether oral or written, do not constitute warranties and should not be relied upon.

If BUNN determines in its sole discretion that the equipment does not conform to the warranty, BUNN, at its exclusive option while the equipment is under warranty, shall either 1) provide at no charge replacement parts and/or labor (during the applicable parts and labor warranty periods specified above) to repair the defective components, provided that this repair is done by a BUNN Authorized Service Representative; or 2) shall replace the equipment or refund the purchase price for the equipment.

THE BUYER'S REMEDY AGAINST BUNN FOR THE BREACH OF ANY OBLIGATION ARISING OUT OF THE SALE OF THIS EQUIPMENT, WHETHER DERIVED FROM WARRANTY OR OTHERWISE, SHALL BE LIMITED, AT BUNN'S SOLE OPTION AS SPECIFIED HEREIN, TO REPAIR, REPLACEMENT OR REFUND.

In no event shall BUNN be liable for any other damage or loss, including, but not limited to, lost profits, lost sales, loss of use of equipment, claims of Buyer's customers, cost of capital, cost of down time, cost of substitute equipment, facilities or services, or any other special, incidental or consequential damages.

BrewWISE, BrewLOGIC, BrewWIZARD, BUNN Gourmet Ice, BUNN Pour-O-Matic, BUNN, Bunn-OMatic, Bunn-O-Matic, BUNNlink, BUNNserve, BUNN Espresso, DBC, Dr. Brew, Dual, EasyClear, EasyGard, Easy Pour, FlavorGard, Gourmet Ice, Gourmet Juice, High Intensity, IMIX, Infusion Series, Quality Beverage Equipment Worldwide, The Mark of Quality in Beverage Equipment Worldwide, My Café, PowerLogic, Safety-Fresh, Scale-Pro, Single, Smart Funnel, Smart Hopper, Smart-WAVE, Soft Heat, SplashGard, System III, ThermoFresh, 392, AutoPOD, AXIOM, Beverage Profit Calculator, Beverage Bar Creator, BrewMETER, BUNNSERVE, BUNNsource, Coffee At Its Best, Cool Froth, Digital Brewer Control, Intellisteam, Nothing Brews Like a BUNN, Pouring Profits, Pulse Wave, Signature Series, Silver Series, Smart Heat, Tea At Its Best, The Horizontal Red Line, Titan, Ultra, are either trademarks or registered trademarks of Bunn-O-Matic Corporation.

TABLE OF CONTENTS

User Notices	4
Electrical Requirements	6
Plumbing Requirements	7
Operating Controls	8
Initial Setup	9
Coffee Brewing	9
Cleaning	9
Glossary	10
PROGRAMMING	11
Programming Switches	11
Programming Flow Chart	12
Programming the Brewer	13
PROGRAM FUNCTIONS (LEVEL 1) Brew Lockout	13
PROGRAM FUNCTIONS (LEVEL 2)	14
Warmer OFF	15
Set New Recipe (using a Smart Funnel and Multi-BrewWISE DBC Grinder)	16
Set Brew Volumes	16
Set Dilution Percentages	17
Set Pulse Brew Times	17
Set Preinfusion Times	17
Set Drip Times	18
Set New Recipe (using a Recipe Card)	19
Set New Recipe (no Smart Funnel or Multi-BrewWISE DBC Grinder)	20
Review Recipes/Modify Recipes/Set up No Name Coffee	21
Set Brew Volumes	22
Set Dilution Percentages	23
Set Pulse Brew Times	24
By Example	26
Enter Times	27
Set Preinfusion Times	28
Set Drip Times	29
Enable Ads	30
Set Temp (Brewing Temperature)	30
Set Ready (Ready Temperature)	30
Refill (Adjust Sensitivity)	31
Spray MI/M (Read sprayhead flow rate)	31
Dilution MI/M (Read dilution flow rate)	31
Calibrate Flow	32
Calibrate Sprayhead Flow	32
Calibrate Dilution Flow	33
Brew Counters (View/Reset)	34
Funnel Lockout	34
Set Units	35
Service Tools	36
Test Outputs (Components)	36
Test Switches	37
Test Warmers	37
Test Frequency	37
Factory Defaults (Reset)	38
Troubleshooting	39
Schematic (Wiring Diagram)	50

USER NOTICES

The notices on this brewer should be kept in good condition. Replace unreadable or damaged labels.

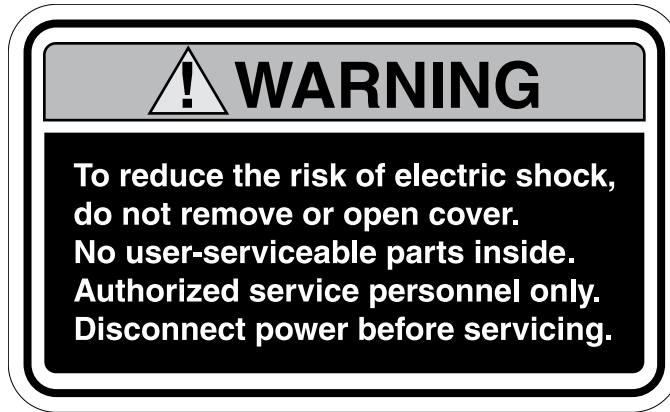

37881.0000

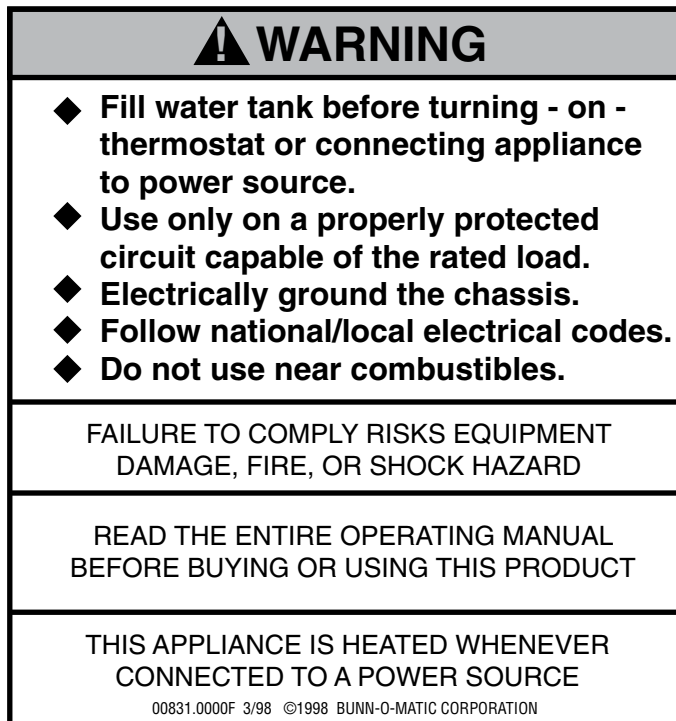

00831.0000



00656.0000

USER NOTICES (continued)



00658.0000



03409.0004



03408.0004



12364.0000



20201.5600

ELECTRICAL REQUIREMENTS

WARNING - If the power cord is ever damaged, it must be replaced by the manufacturer or its service agent with a special cord available from the manufacturer or its service agent in order to avoid a hazard.

Refer to Data Plate on the Brewer, and local/national electrical codes to determine circuit requirements.

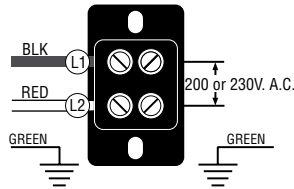

200 or 230V ac single phase models

Note: This electrical service consists of 2 current carrying conductors (L1 and L2) and a separate conductor for earth ground.

ELECTRICAL HOOK-UP

CAUTION – Improper electrical installation will damage electronic components.

1. An electrician must provide electrical service as specified.
2. Using a voltmeter, check the voltage and color coding of each conductor at the electrical source.
3. This brewer comes with an attached cordset.
4. Remove the front panel beneath the sprayhead.
5. Connect the brewer to the power source and verify the voltage at the terminal block before proceeding. Replace the front panel.
6. If plumbing is to be hooked up later be sure the brewer is disconnected from the power source. If plumbing has been hooked up, the brewer is ready for *Initial Set-Up*.

CE REQUIREMENTS

- This appliance must be installed in locations where it can be overseen by trained personnel.
- For proper operation, this appliance must be installed where the temperature is between 5°C to 35°C.
- Appliance shall not be tilted more than 10° for safe operation.
- An electrician must provide electrical service as specified in conformance with all local and national codes.
- This appliance must not be cleaned by water jet.
- This appliance is not intended for use by persons (including children) with reduced physical, sensory or mental capabilities, or lack of experience and knowledge, unless they have been given instructions concerning use of this appliance by a person responsible for its safety.
- Children should be supervised to ensure they do not play with the appliance.
- If the power cord is ever damaged, it must be replaced by the manufacturer or authorized service personnel with a special cord available from the manufacturer or its authorized service personnel in order to avoid a hazard.

PLUMBING REQUIREMENTS

This brewer must be connected to a cold water system with operating pressure between 20 and 90 psi (138 and 620 kPa) from a $\frac{1}{2}$ " or larger supply line. A shut-off valve should be installed in the line before the brewer. Install a regulator in the line when pressure is greater than 90 psi (620 kPa) to reduce it to 50 psi (345 kPa). The water inlet fitting is $\frac{1}{4}$ " flare or female quick connect.

NOTE – Bunn-O-Matic recommends $\frac{1}{4}$ " copper tubing for installations of less than 25 feet and $\frac{3}{8}$ " for more than 25 feet from the $\frac{1}{2}$ " water supply line. A tight coil of copper tubing in the water line will facilitate moving the brewer to clean the counter top. Bunn-O-Matic does not recommend the use of a saddle valve to install the brewer. The size and shape of the hole made in the supply line by this type of device may restrict water flow.

This equipment must be installed to comply with the International Plumbing Code of the International Code Council and the Food Code Manual of the Food and Drug Administration (FDA). For models installed outside the U.S.A., you must comply with the applicable Plumbing/Sanitation Code for your area.

PLUMBING HOOK-UP

1. Attach the flare fitting from the short piece of tubing on the strainer/flow control (supplied) to the water inlet fitting on the back of the brewer.
2. Flush the water line and securely attach it to the flare fitting located on back of brewer.
3. Turn on the water supply.

OPERATING CONTROLS

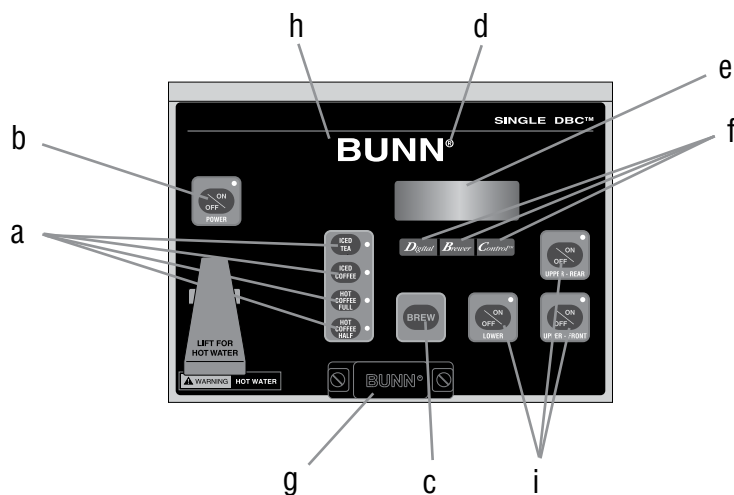

P3200-1

OPERATING CONTROLS

(a) BATCH SELECTOR PADS

Pressing the pad corresponding to the recipe selects the amount of beverage to be brewed. Pressing a different pad after a brew cycle has been initiated does not change the brew in progress. Light indicates the selected recipe to brew.

(b) ON/OFF PAD

Pressing the ON/OFF pad alternately turns the brewer on and off. Pressing this pad during the brew cycle will interrupt the brew cycle, stopping the flow of water. Pressing this pad during the programming of the brewer will exit the setup and return to the main screen.

(c) BREW PAD

Momentarily pressing and releasing this pad begins a brew cycle.

(d) ® PAD

Pressing and holding the ® pad allows entry to the programming menus. Pressing and releasing the pad steps through each function screen during programming.

(e) FUNCTION SCREEN

This is the display which shows the various functions of the brewer and allows the programming to be accomplished.

(f) FUNCTION SCREEN PADS

These are the hidden pads which are used to program the brewer.

(g) FUNNEL SENSING COIL

This is used to "receive" information from the Smart Funnel handle (recipe name and batch size), and also from **RECIPE CARDS**.

(h) SCROLL BACKWARDS

The upper left corner of the B in BUNN can be used to scroll backwards through the function list.

(i) WARMER PLATE ON/OFF PADS

Pressing these ON/OFF pads alternately turn the warmer plates on and off.

INITIAL SETUP

CAUTION – The brewer must be disconnected from the power source throughout the initial setup, except when specified in the instructions.

1. Insert an empty funnel into the funnel rails of the brew station.
2. Place an empty server under the funnel.
3. Connect the brewer to the power source. Water will begin flowing into the tank and stop when the tank is filled to its capacity. Display will show **PLEASE WAIT...TANK FILLING** until tank is filled with water.

OPERATING CONTROLS (cont.)

4. Wait approximately twenty minutes for the water in the tank to heat to the proper temperature. Display will show **READY TO BREW...WATER TEMP: XXX°** when tank is at operating temperature.
5. Place a small vessel beneath the faucet and open the faucet handle. Release it when you hear the tank refilling.
6. Water volumes have been preset at the factory. Refer to adjustments for the *Set Brew Volumes* section of this manual should the volume need to be increased or decreased.
7. The brewer is now ready for use in accordance with the coffee brewing instructions.

COFFEE BREWING

1. Select the desired recipe on the grinder. It is not necessary to select a recipe on the brewer.
2. Insert a BUNN filter into the funnel.
3. Grind the proper amount of fresh coffee into the Smart Funnel using the Multi-BrewWISE DBC grinder with Smart Funnel operation and level the grounds by gently shaking.
4. Slide the funnel into the funnel rails. The brewer will read the recipe ground through the chip in the funnel handle and will automatically select the correct recipe to brew. If the grounds are not obtained through a grinder compatible with a Smart Funnel, a recipe must be chosen on the brewer.
5. Place an empty server under the funnel.
6. Press the "ON/OFF/POWER" pad and release.
7. Press the "ON/OFF/LOWER" warmer pad and release.
8. Momentarily press and release the "BREW" pad. If the brewer has the funnel lock option and if it is activated, once a brew cycle has been started the funnel is locked in place. There may be certain situations in which the brew cycle will not begin when "BREW" is pressed:
 - a) **BREW TEMPERATURE TOO LOW** - wait until heated or cancel **BREW LOCKOUT** option. (Page 13)
 - b) **FUNNEL NOT PRESENT** (or using a standard brew funnel) - cancel **FUNNEL LOCKOUT** option. (Page 34)
 - c) **CHECK FUNNEL** - remove funnel, empty previously brewed grounds and grind a new batch into the funnel.
 - d) **SWITCH NOT ON** - Press the "ON/OFF/LOWER" warmer pad to ON and release. (Page 36)
9. If none of the above messages are displayed, the display will read **NOW BREWING**.
10. Following the BREW will be a countdown of drip time **DRIPPING** which shows the time remaining for drip-out until the funnel lock will release. Discard the grounds and filter only after visible dripping stops.

CLEANING

1. The use of a damp cloth rinsed in any mild, nonabrasive, liquid detergent is recommended for cleaning all surfaces on Bunn-O-Matic equipment.
2. Check and clean the sprayhead. Use the pointed end of sprayhead cleaning tool (#38227.0000) to remove any mineral deposits from the sprayhead holes.
3. Insert the long end of sprayhead cleaning tool into the sprayhead fitting, and rotate several times to remove any mineral deposits from the fitting.
4. Insert the short end of sprayhead cleaning tool into the bypass fitting, and rotate several times to remove any mineral deposits from the fitting.

NOTE: In hard water areas, this may need to be done daily. It will help prevent liming problems in the brewer and takes less than a minute.

GLOSSARY

- AD CARD:** An assembly consisting of a computer chip and an instruction label. Used for loading advertising messages into the brewer.
- BREW LOCKOUT:** The inability to initiate a brew if the water temperature is less than the ready temperature programmed into the brewer.
- CHIP:** A computer chip containing either recipes for specific coffee flavors or advertising messages which are read by the sensing coils on the brewer. One chip is embedded in each Smart Funnel® handle to carry the coffee flavor name and batch size ground from the grinder to the brewer.
- DILUTION:** Ambient water added for dilution of tea concentrate.
- DRIP TIME:** The length of time from when the water spray over the grounds ends, to the time that no water drips from the funnel tip.
- FACTORY DEFAULTS:** The factory preset brew settings that were installed into the brewer's memory.
- FIRST ON-TIME:** During a pulse brew, this is the time set for the initial flow of water over the grounds.
- FUNNEL DETECT:** Sets the inability to initiate a brew cycle if the funnel is not properly inserted into the funnel rails.
- FUNNEL SENSING COIL:** A sensor on the front hood of the brewer, which reads what name and batch size of coffee was ground into the funnel and allows for the brewer to automatically set itself to what is read from the funnel handle.
- LAST ON-TIME:** During a pulse brew, this is the time set for the second on-time, and each alternating on-time for the remainder of the brew cycle.
- MAIN SCREEN:** The term used to describe the screen that is displayed when the brewer is not in use. This screen is also displayed after exiting the programming mode.
- NO-NAME COFFEE:** The term for the recipe used by the brewer when there is no coffee name stored in the funnel.
- OFF-TIME:** During a pulse brew or preinfusion, this is the time set for the length of time that the water is not spraying over the grounds.
- PREINFUSION:** The process of beginning a brewing cycle with an initial spray of water onto the grounds followed by a pause in the spray. After the programmed pause, the spray continues without interruption until the end of the brewing cycle.
- PULSE BREW:** The process which allows the brew water to start, then stop, repeatedly, over the grounds in order to derive the best flavor from the coffee. Pulse brew is also used in some instances to prevent a funnel overflow.
- RECIPE:** Set of brewing parameters stored in the brewer. The parameters are unique for each coffee name and include brew ounces, pulse brew, percent bypass, preinfusion and drip time.
- RECIPE CARD:** An assembly consisting of a computer chip and an instruction label. Used for loading a recipe into the brewer and the companion BrewWISE Grinder.

PROGRAMMING

Using the menu-driven display on the front of the brewer, the operator has the ability to alter or modify various brewing parameters such as brew temperatures, brew volumes, bypass percentages, etc. This allows for the precise brewing of various flavors of coffee.

Programming of the brewer is achieved by entering a certain function. Then, by the use of hidden programming switches, the operator can customize the brewing process to their specifications.

PROGRAMMING SWITCHES

To access the programming mode, and to scroll through the different function screens, hidden programming switches are used. There are five of these switches that will be used for the setup of the brewer.

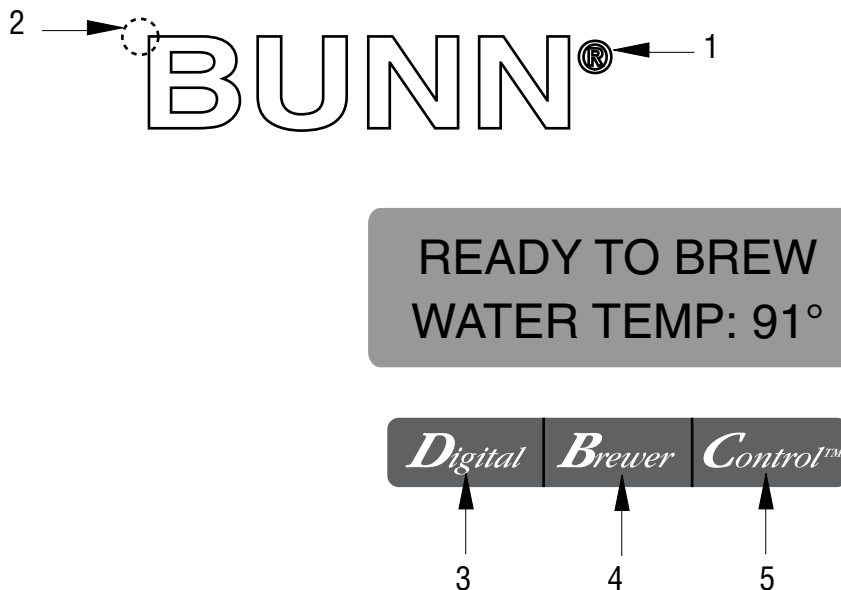

1. **® symbol** (upper right of the BUNN logo)
This is used to access the programming mode and is also used to scroll forward through the function list.
2. **Upper left corner** of the "B" in the BUNN logo
This is used to scroll backwards through the function list.
3. **"Digital"** (lower left under the display)
This is used to select options that appear on the display during programming.
4. **"Brewer"** (center under the display)
This is used to select options that appear on the display during programming.
5. **"Control"** (lower right under the display)
This is used to select options that appear on the display during programming.

PROGRAMMING THE BREWER

PROGRAMMING FUNCTIONS - FLOW CHART

PROGRAMMING FUNCTIONS - LEVEL 1

BREW LOCKOUT?
NO DONE YES

Digital Brewer Control™

PROGRAMMING FUNCTIONS - LEVEL 2

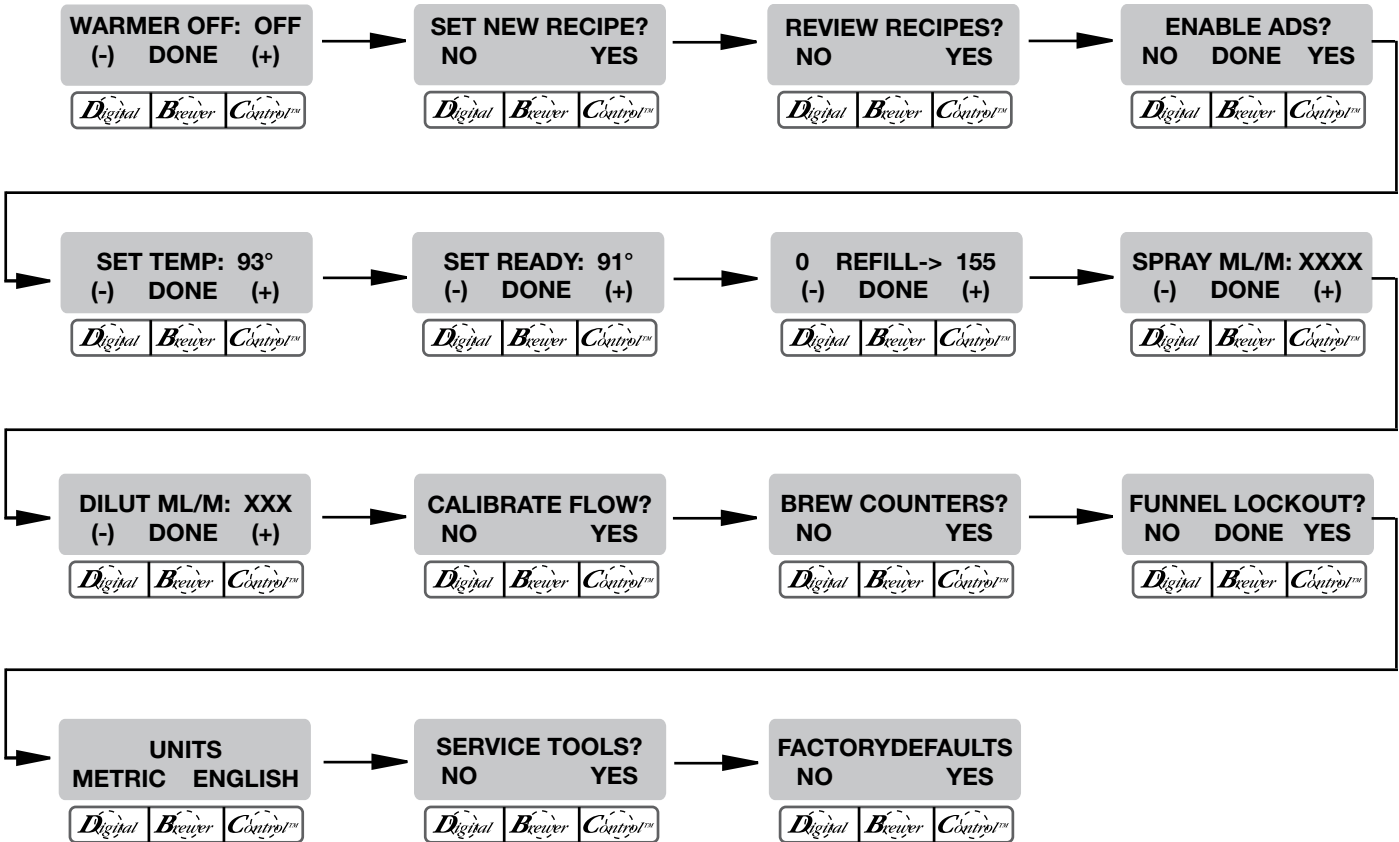

PROGRAMMING THE BREWER

The programming of the brewer is divided into two levels. There is one function in Level 1. All other functions are accessed in Level 2.

The following function screens are in order of appearance. Each screen will have instructions on how to access, and the procedures to program the various functions of the brewer.

IMPORTANT PROGRAMMING NOTES - READ CAREFULLY -

To exit the programming mode at any time, press and release the "ON/OFF/LOWER" pad located on the front switch panel. The display will return to the **MAIN SCREEN**.

If none of the five programming switches are pressed within one minute during the setup of the brewer, the programming of the function screen that is being set will be exited and the display will return to the **MAIN SCREEN**.

Always remember to place a container and funnel under the sprayhead when operating the brewer during the set-up of **PULSE BREW - SET BY EXAMPLE, CALIBRATE FLOW** and testing the brew and bypass valves in **SERVICE TOOLS/TEST OUTPUTS**.

MAIN SCREEN



This screen will be shown when the brewer is ready for use. The screen displays the water temperature in the tank. When the water in the tank reaches the correct set temperature, the display will change from **HEATING** to **READY TO BREW**.

PROGRAMMING LOCKOUT SWITCH (mounted on main control board)

This switch can be set to prevent access to the programming levels of the brewer. Once all the correct brew settings are programmed, the operator can set the switch to the "DISABLE" position to prohibit anyone from changing the settings.

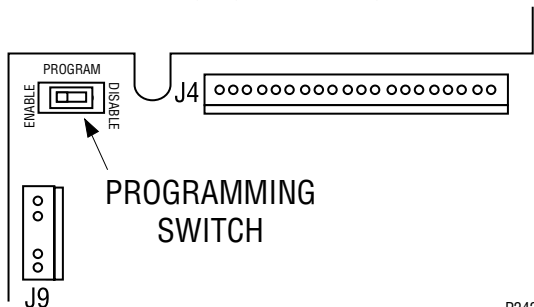

P2424

PROGRAMMING FUNCTIONS - LEVEL 1 BREW LOCKOUT

This function allows the operator to prevent or allow brewing if the water temperature is less than the set **READY** temperature.

To access this function screen press and hold the © symbol. Release the © when the display reads:

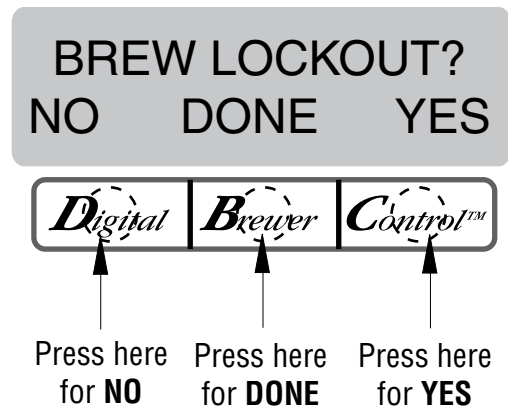

The **YES** or **NO** should be flashing. Select **YES** to prevent brewing if the water temperature is below the set **READY** temperature. Select **NO** to permit brewing at any water temperature.

When finished, press and release **DONE**. This will exit this function screen and return to the **MAIN SCREEN** on the display.

PROGRAMMING THE BREWER (cont.)

PROGRAMMING FUNCTIONS - LEVEL 2

There are three methods of programming the various brewing parameters of the Single Multi-BrewWISE DBC with Smart Funnel brewer.

METHOD 1:

Using a Smart Funnel and a Single Multi-BrewWISE DBC Grinder:

Certain coffee **NAMES** are stored in the Multi-BrewWISE DBC Grinder's memory. When a particular name of coffee is ground into the Smart Funnel, that name and the batch size selected are transferred from the grinder to the programming **chip** located in the funnel's handle. The funnel is then inserted into the brewer's funnel rails. The sensor coil on the brewer reads the information contained in the handle. This then allows the operator to set the **BREW VOLUMES, DILUTION PERCENTAGES, PULSE BREW TIMES, PREINFUSION TIMES** and **DRIP-OUT TIMES** for that particular coffee **NAME**. Each coffee **NAME** can be set individually to provide optimum brewing quality.

RECIPES

This diagram allows for the creating, modifying, or viewing of recipes in the brewer.

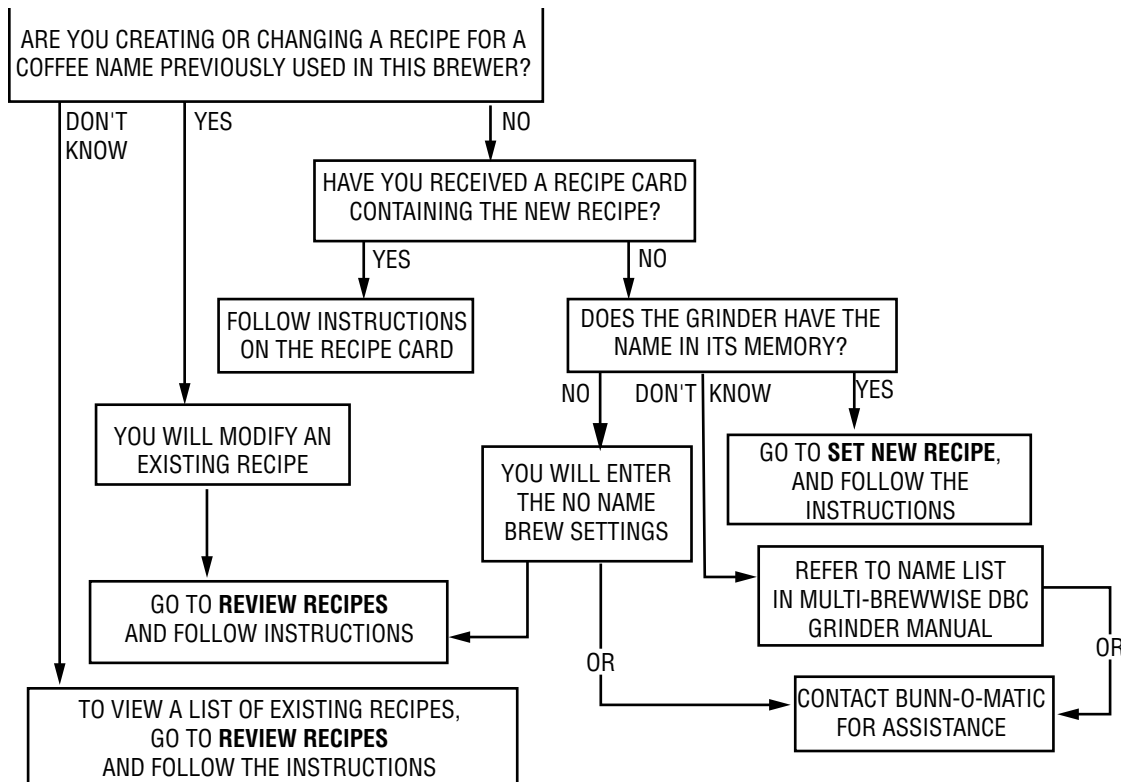

METHOD 2:

Using a RECIPE CARD to enter all of the brew settings at one time:

If using a coffee flavor not in the Single Multi-BrewWISE DBC Grinder's memory, the customer can obtain a **RECIPE CARD** from the factory with all the information needed to set up that particular coffee flavor. This includes the name of the coffee, **BREW VOLUMES, DILUTION PERCENTAGES, PULSE BREW TIMES, PREINFUSION TIMES,** and **DRIP-OUT TIMES.**

METHOD 3:

Not using a Smart Funnel and/or a Single Multi-BrewWISE DBC Grinder:

This allows the operator to enter **ONE** set of brewing parameters in the event a Smart Funnel and/or a Single Multi-BrewWISE DBC Grinder is not used with the Single Multi-BrewWISE DBC Brewer. This is referred to as a **NO NAME** coffee flavor. If the brewer does not read the information in the funnel handle, it automatically selects the **NO NAME** brewing parameters set up prior to brewing. This includes the **BREW VOLUMES, DILUTION PERCENTAGES, PULSE BREW TIMES, PREINFUSION TIMES** and **DRIP-OUT TIMES** for all batch sizes.

PROGRAMMING FUNCTIONS - LEVEL 2 (cont.)

WARMER OFF:

This function allows the operator to set a predetermined time for the warmer to shut off in a range from 15 minutes to 6 hours in increments of 15 minutes.

Procedures to set the warmer shut off time:

1. Press and hold the **Ⓜ** pad until the display reads **WARMER OFF**.
2. Pressing **(-)** in this screen will count down the shut off time starting at 6:00 hours and decrease in increments of 0:15 minutes.
3. Pressing **(+)** in this screen will set the shut off time at 0:15 minutes and count up to 6:00 hours in increments of 0:15 minutes.
4. When finished, press **DONE** to advance to the next function screen, or press the "ON/OFF/LOWER" pad on the front switch panel to exit the **WARMER OFF** function and return to the **MAIN SCREEN**.

NOTE: For whatever time is selected for the warmers to shut off, the warmer switch LED will begin to flash 5 minutes prior to shutting off.

NOTE: For ICED Beverages (Tea and Coffee), the lower warmer will not be energized. This will allow for a lower temperature in the final product. Some residual heat may still be present when immediately following the brewing of a hot beverage.

WARMER OFF: OFF
(-) DONE (+)

Digital *Brewer* *Control™*

PROGRAMMING FUNCTIONS - LEVEL 2 (cont.)

SET NEW RECIPE - METHOD 1

Using a Smart Funnel and a Single Multi-BrewWISE DBC Grinder:

This function allows the operator to set **BREW VOLUMES, DILUTION PERCENTAGES, PULSE BREW TIMES, PREINFUSION TIMES** and **DRIP-OUT TIMES** for each coffee name preset in the grinder's memory.

Certain coffee **NAMES** are stored in the MULTI-BREWWISE DBC Grinder's memory. When a particular name of coffee is ground into the Smart Funnel, that name and the batch size selected are transferred from the grinder to the programming **chip** located in the funnel handle. The funnel is then inserted into the brewer's left side funnel rails. The sensor coil on the brewer reads the information contained in the handle. The name of the coffee flavor will then appear on the display. This then allows the operator to set the **BREW VOLUMES, DILUTION PERCENTAGES, PULSE BREW TIMES, PREINFUSION TIMES** and **DRIP-OUT TIMES** for that particular coffee **NAME**. It also allows the operator to set other brewing parameters, such as **BREW TEMPERATURE, READY TEMPERATURE, BREW LOCKOUTS**, etc. Each coffee **NAME** can be set individually to provide optimum brewing quality.

Procedure for Setting the Recipe:

NOTE: Before beginning setup, place a GPR server beneath the sprayhead.

1. Insert the funnel into the grinder and select a batch size to grind. It is not necessary to have coffee beans in the hopper(s) in order to program the brewer. The coffee name is pre-selected and stored in the grinder's memory for the side being ground.
2. Press the "GRIND" pad. When the grinder stops grinding, remove the funnel.
3. On the brewer, press and hold the $\text{\textcircled{R}}$ pad until the display reads **WARMER OFF**. Press the $\text{\textcircled{R}}$ pad until the display reads **SET NEW RECIPE**. Release the $\text{\textcircled{R}}$ pad.
4. Press and release **YES**. The display should read **INSERT FUNNEL WITH NEW NAME**, then **QUIT SETUP?** These two displays will repeatedly cycle.
5. Insert the funnel into the rails of the brewer. The display should read the **NAME** of the coffee that was ground into the funnel, along with a **NO** and **YES**. If the **NAME** on the display is correct, press **YES**.
6. If, for some reason, the name of the coffee from the grinder did not load properly into the funnel, or if a grind has not yet been done, the display will read **MUST GRIND INTO FUNNEL FIRST**. It will be necessary to grind another batch following steps 1 and 2.
7. If the grind is acknowledged by the brewer, the display will read **BEGIN SETUP OF (RECIPE NAME)**. Then the screen will display **BREW MI.** and a batch light will be blinking. (Refer to page 22 for description of **BREW MI.** function).

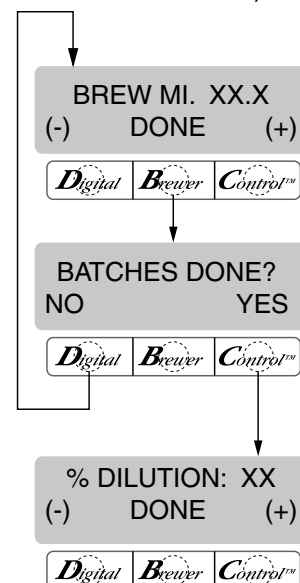
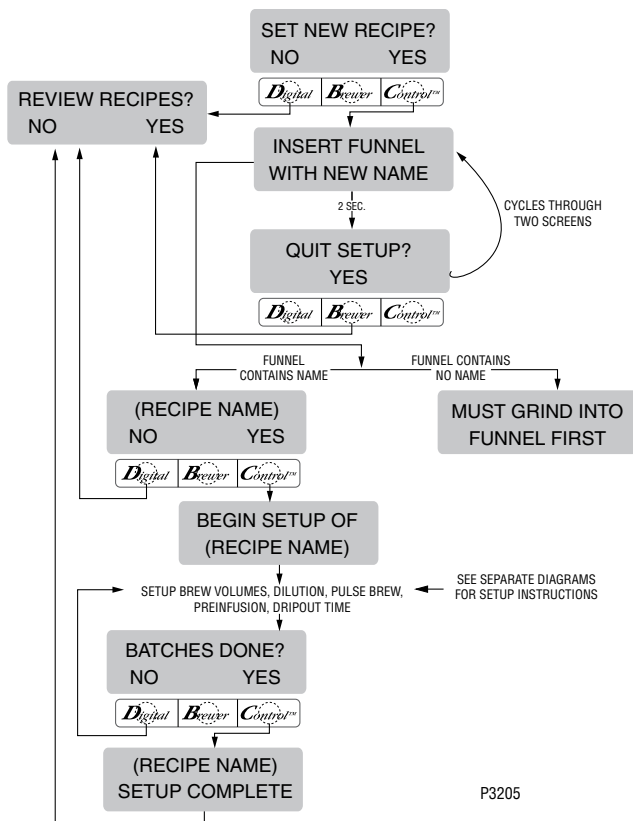

PROGRAMMING FUNCTIONS - LEVEL 2 (cont.)

SET NEW RECIPES - METHOD 1 (cont.)

8. Using (-) and (+), set the amount of brew water, in ounces, to be dispensed **over** the grounds for that particular batch size.
9. When finished, press another batch size and repeat step #8 for that size. Continue setting all batch sizes.
10. When finished setting all batch sizes, press and release **DONE**. The display should read **BATCHES DONE?**
11. If the three batch sizes are not correct, press and release **NO** to return to the **BREW MI** setup screen and repeat steps 8 through 10. If all batch sizes are correct, press **YES**. This will advance to the **% DILUTION:** function. (Refer to page 23 for description of **% DILUTION:** function.)

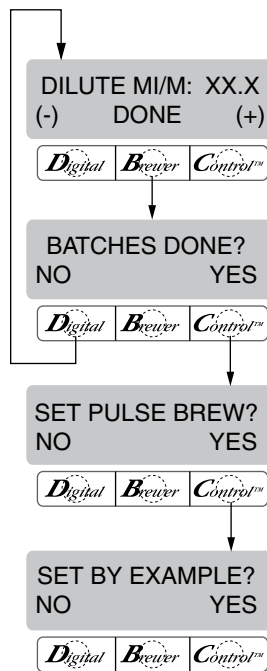

P3207

12. Using (-) and (+) set the amount of dilution water (percentage) to be dispensed **around** the grounds for that particular batch size.
13. When finished, press another batch size and repeat step #12 for each batch to be set.
14. When finished setting each batch size, press **DONE**. The display should read **BATCHES DONE?**
15. If all batch sizes are not correct, press and release **NO** to return to the **DILUTE MI/M:** setup screen and repeat steps 12 through 15. If they are correct, press **YES**. This will advance to **SET PULSE BREW**. (Refer to page 24 for description of **SET PULSE BREW** function.)

16. To **SET PULSE BREW**, if setting pulse brew **BY EXAMPLE** (brewing into a funnel) press **YES** and proceed with the setup instructions for **SETTING PULSE BREW - BY EXAMPLE**, on page 26.
17. If setting pulse brew by **ENTER TIMES** (entering known times) press **NO**. The display should read **ENTER TIMES**. Press and release **YES** and proceed with the setup instructions for **SETTING PULSE BREW - ENTER TIMES**, page 27. After **SET PULSE BREW** has been accomplished, the next function will be **SET PREINFUSION**. (Refer to page 28 for description of **SET PREINFUSION** function.)

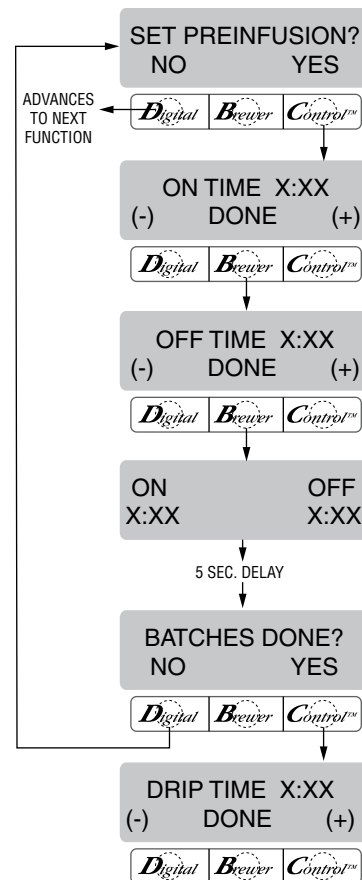

P3208

18. To **SET PREINFUSION** press **YES** in the **SET PREINFUSION** screen to proceed. The display should now read **ON TIME** and a batch light will be blinking.
19. Using (-) and (+), set the amount of time the brew water will initially **presoak** the grounds for that particular batch size.
20. When finished, press another batch size and repeat until all batch sizes are set.
21. When finished, press **DONE**. The display should now read **OFF TIME** and a batch light will be blinking.

PROGRAMMING FUNCTIONS - LEVEL 2 (cont.)

SET NEW RECIPES - METHOD 1 (cont.)

22. Using **(-)** and **(+)**, set the amount of time the brew cycle will delay (after the presoak cycle shuts off) before resuming brewing.
23. When finished, press another batch size and repeat until all batch sizes are set.
24. When finished setting all batch sizes, press **DONE**. The display will show the **ON** and **OFF TIMES** that were entered for a particular batch size. After a 5 second delay, the display should read **BATCHES DONE**.
25. If all batches are not complete, press **NO** in order to return to **SET PREINFUSION**, and repeat steps 19 through 24.
26. If all batches are correct, press **YES**. This will advance to the next function, **SET DRIP TIME**. (Refer to page 29 for description of **SET DRIP TIME** function.)
27. The display should now read **DRIP TIME**, along

- with either the word **OFF**, or a time will be showing. A batch light should also be blinking.
28. Using **(-)** and **(+)**, set the amount of time from when the brew spray ends to when the funnel is emptied of hot liquid for that batch size.

NOTE: Set to **OFF** to prevent funnel locks from engaging (to disable this function), for a particular batch size. To set to **OFF**, continue to press and release **(-)** until **OFF** appears on the screen.

29. When finished, press another batch size and repeat step 28 until all three sizes are set.
30. When finished setting all batch sizes press **DONE**. The display should read **BATCHES DONE?**
31. If all batch sizes are not correct, press **NO** to return to the **DRIP TIME** setup screen and repeat steps 28 through 30.
32. If all batch sizes are correct, press **YES**. The screen should show the name of the coffee being programmed (modified) along with **SETUP COMPLETE**.
32. After a 5 second delay, the display will advance to the next coffee name in the brewer's memory. If no other coffee names are present, the display will read **THAT WAS THE LAST RECIPE**, and return to the **REVIEW RECIPES** screen.

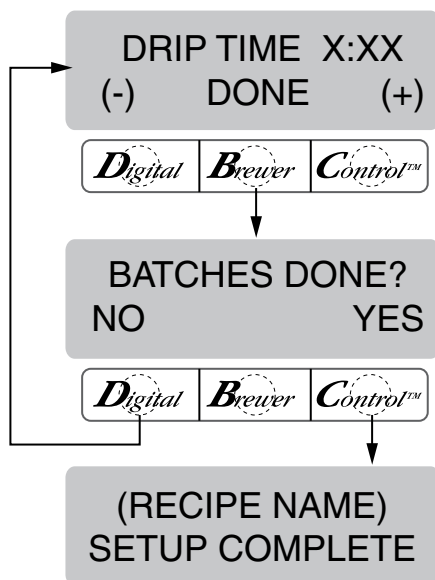

P3209

PROGRAMMING FUNCTIONS - LEVEL 2 (cont.)

SET NEW RECIPE - METHOD 2

Using a **RECIPE CARD** to load coffee names and brew settings into the Single Multi-BrewWISE DBC with Smart Funnel:

The Multi-BrewWISE DBC Grinder's memory contains certain coffee names. If the operator uses a coffee name that is not already stored in the grinder's memory, a **RECIPE CARD** can be obtained from the factory. The **RECIPE CARD** would include all the information needed to set up that particular coffee name. The information from the **RECIPE CARD** is loaded into the grinder's memory, then into the brewer's memory by holding the recipe card up to the equipment's sensing coil. This information can include the coffee name, **BREW VOLUMES, DILUTION PERCENTAGES, PULSE BREW TIMES, PREINFUSION TIMES** and **DRIP-OUT TIMES** for that particular recipe **NAME**. These can all be loaded in seconds.

Contact Bunn-O-Matic Corporation for the availability of **RECIPE CARDS**.

NOTE: Instructions to program the brewer and grinder are printed on the **RECIPE CARD**, along with the coffee name that is being programmed.

Procedure to program the coffee name:

1. Remove the funnel (if present) from the funnel rails.
2. Position the **RECIPE CARD** vertically, so that the top end of the **chip** is beneath the funnel sensing coil.
3. After a short pause the display will read **CARD CONTAINS RECIPE FOR** then will change to **(RECIPE NAME) SHOW QUIT SAVE**. All brewing parameters for that coffee flavor are now transferred from the **CARD** to the brewer.
4. To show (view) this information, press and release **SHOW**. The display will scroll through all of the brew settings for all batch sizes. The display will then return to **CARD CONTAINS RECIPE FOR** then will change to **(RECIPE NAME) SHOW QUIT SAVE**.

5. If all brew settings are correct, press **SAVE**. The display will read **(RECIPE NAME) SETUP COMPLETE**. All brew settings for that name are now stored in the brewer's memory.
6. If the brewing information is not correct, or it is desired to exit the setup before the settings are loaded into the brewer's memory, press **QUIT**. The display will read **(RECIPE NAME) NOT SAVED**. The display will then return to the **MAIN SCREEN**.

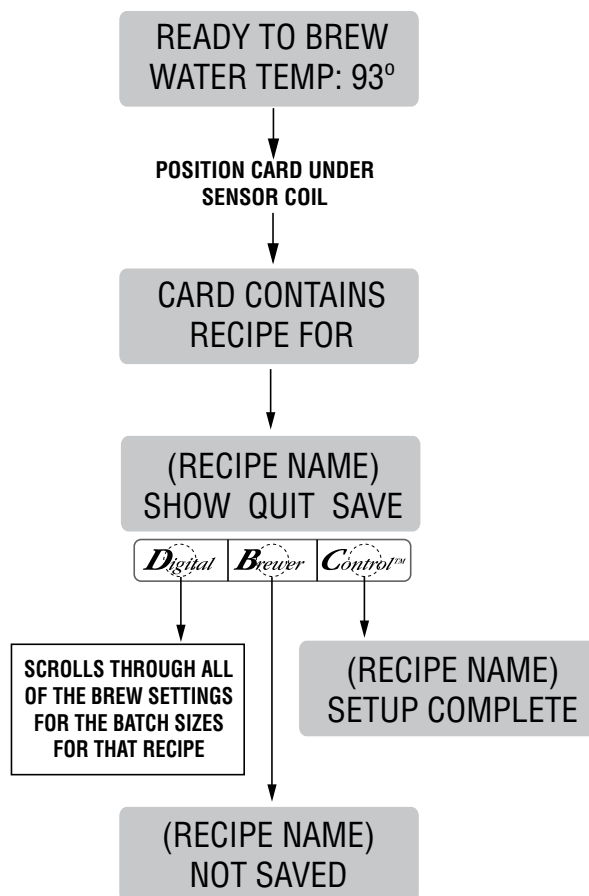

P3210

PROGRAMMING FUNCTIONS - LEVEL 2 (cont.)

SET NEW RECIPE - METHOD 3

If not using a Smart Funnel (with a sensor coil) and/or a Single Multi-BrewWISE DBC Grinder, the brewer will function as a standard BUNN Single Multi-BrewWISE DBC Brewer:

It is possible to operate the brewer without using a Smart Funnel and/or a DBC Grinder. If a standard funnel, or if a non-DBC grinder is used the brewer will automatically select a **NO NAME** coffee flavor when the "BREW" pad is pressed. This means that no name was read from the funnel's handle.

There is a **NO NAME** coffee program that can be set in the brewer. This includes **BREW VOLUMES, DILUTION PERCENTAGES, PULSE BREW TIMES, PREINFUSION TIMES** and **DRIP-OUT TIMES**. The brewer will perform in the same capacity as a standard BUNN Single Multi-BrewWISE DBC Brewer.

The instructions for programming the **NO NAME** settings are on the following pages. The same steps are followed for setting the recipe as those that are used to **MODIFY A RECIPE**, beginning on page 21.

Note that when the display reads **NO NAME**, that is when **MODIFY** should be pressed in order to set the parameters for the **NO NAME** coffee.

NOTE: Before beginning setup, insert a funnel into the funnel rails, and place a server beneath the brew funnel.

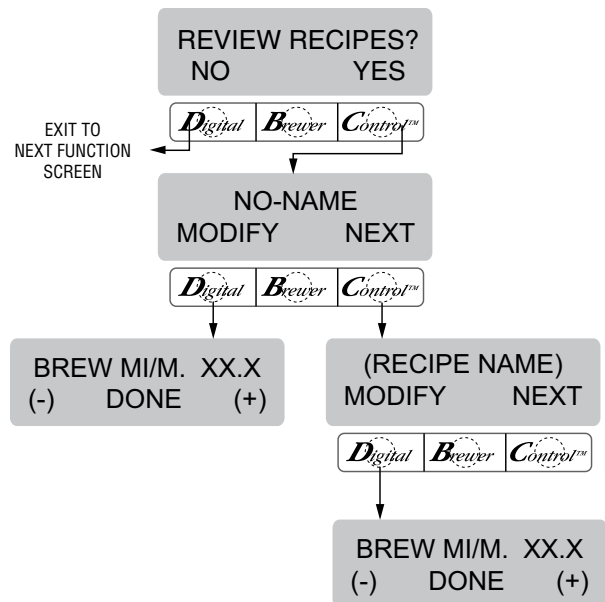

P3211

PROGRAMMING FUNCTIONS - LEVEL 2 (cont.)

REVIEW RECIPES/MODIFY RECIPES/SET UP NO NAME COFFEE FLAVORS:

This function has three parts. It allows the operator to view the brew settings for the various beverage names programmed into the brewer.

It also allows the operator to modify (change) any of the **BREW VOLUMES, DILUTION VOLUMES, PULSE BREW TIMES, PRE-INFUSION TIMES** and **DRIP-OUT TIMES** for a particular beverage name programmed into the brewer.

Finally, this function is used to set up the **NO NAME** beverage **BREW VOLUMES, DILUTION PERCENTAGES, PULSE BREW TIMES, PRE-INFUSION TIMES** and **DRIP-OUT TIMES**.

Procedure for reviewing recipes:

1. Press and hold the **®** pad until the display reads **SET NEW RECIPES**. Release the **®**. Press the **®** until the display reads **REVIEW RECIPES**.
2. Press **YES** to proceed. The display should now read **NO NAME**, along with **MODIFY** and **NEXT**.
3. To advance to the next beverage name, press **NEXT**.
4. To exit, press **NEXT** until the display reads **THAT WAS THE LAST RECIPE**.
5. After 5 seconds, the display will return to the **REVIEW RECIPES** screen. Press and release **NO** to advance to the next function screen, or press the "ON/OFF/LOWER" pad located on the front switch panel to exit the programming mode and return to the **MAIN SCREEN**.

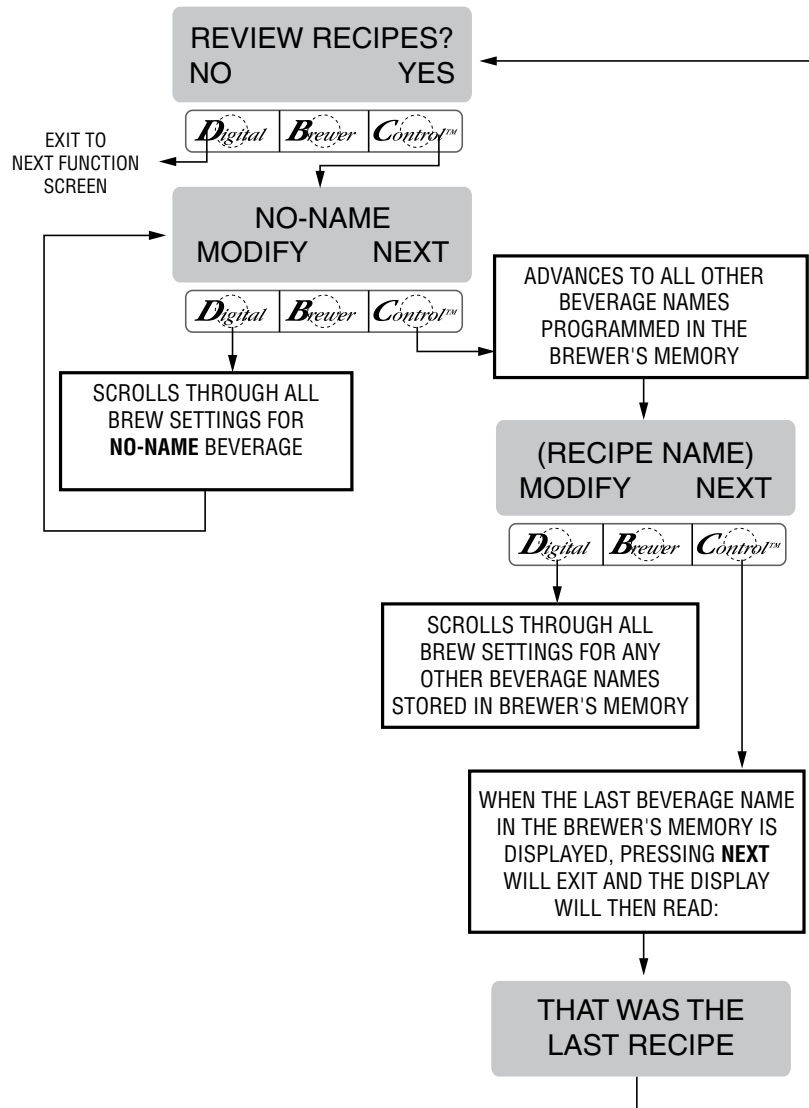

PROGRAMMING FUNCTIONS - LEVEL 2 (cont.)

BREW MI: (SETTING OR ADJUSTING BREW VOLUMES)

This function allows adjustment of the brew volumes for each batch. The indicator signifies volume in ounces per batch.

Procedure for modifying recipes - brew ounces: Range: 100.0 ml to 8000 ml for all batch sizes

1. Press and hold the **Ⓜ** pad until the display reads **WARMER OFF**. Release the **Ⓜ** pad. Press the **Ⓜ** until the display reads **REVIEW RECIPES**.
2. Press **YES** to proceed. The display should now read **NO NAME**, along with **MODIFY** and **NEXT**.
3. Press and release **NEXT** to advance to the desired coffee name to be modified.
4. Press and release **MODIFY**. The display should read **BREW OZ** and a batch light will be blinking. Press and release the batch size to be modified.

5. Using **(-)** and **(+)**, set the amount of brew water, in ounces, to be dispensed **over** the grounds/tea for that particular batch size.
6. When finished, press another batch size and repeat step #5 for that size for each batch size to be modified. Continue setting all batch sizes.
7. When finished setting all batch sizes, press and release **DONE**. The display should read **BATCH SIZES DONE?**
8. If all batch sizes are not correct, press and release **NO** to return to the **BREW MI/M** setup screen and repeat steps 5, 6 and 7.
9. If all batch sizes are correct, press **YES**. This will advance to the **% DILUTION** function. Another alternative is to press the "ON/OFF/LOWER" pad to exit the **BREW MI/M** setup and return to the **MAIN SCREEN**.

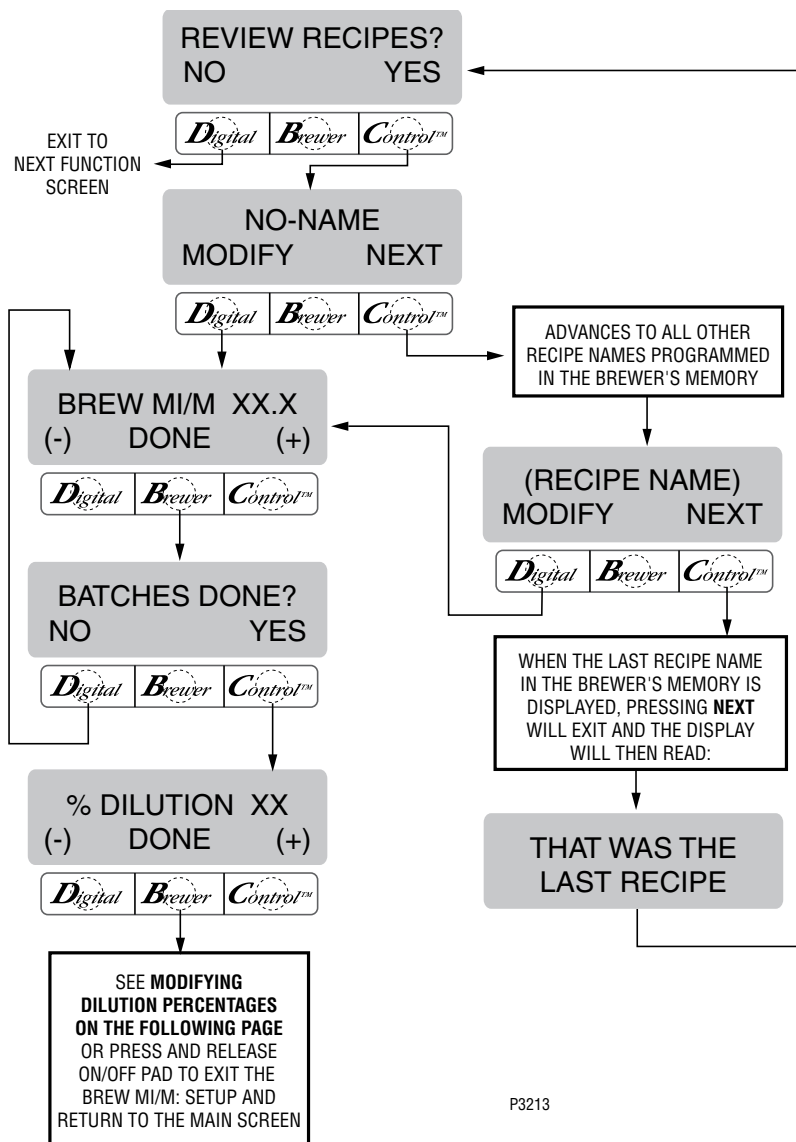

P3213

PROGRAMMING FUNCTIONS - LEVEL 2 (cont.)

% DILUTION

This function allows adjustment of the amount of water that flows passed the grounds. The number signifies the percentage of the brew volume which does not flow over the coffee grounds/tea.

Modifying recipes - dilution percentages:
Range: 0% to 90% for all batch sizes

NOTE: If the brewer is already in the % **DILUTION** screen, it is not necessary to follow steps 1 through 6 in this section, but proceed directly to step 7.

1. Press and hold the **Ⓢ** pad until the display reads **WARMER OFF**. Release the **Ⓢ** pad. Press the **Ⓢ** until the display reads **REVIEW RECIPES**.
2. Press **YES** to proceed. The display should now read **NO NAME**, along with **MODIFY** and **NEXT**.
3. Press and release **NEXT** to advance to the desired recipe name to be modified.

4. Press and release **MODIFY**. The display should read **BREW MI/M**.
5. Press and release **DONE**. The display should read **BATCHES DONE?**.
6. Press and release **YES**. The display should now read **% DILUTION**, and a batch light will be blinking. Press and release the batch size to be modified.
7. Using **(-)** and **(+)** set the amount of dilution water (percentage) to be dispensed **around** the grounds for that particular batch size.
8. When finished, press another batch size and repeat step #7 for each batch to be modified.
9. When finished setting all batch sizes, press **DONE**. The display should read **BATCHES DONE?**
10. If they are not correct, press and release **NO** to return to the % **DILUTION** setup screen.
11. If all batch sizes are correct, press **YES**. This will advance to **SET PULSE BREW**. Another alternative is to press the "ON/OFF/LOWER" pad to exit the % **DILUTION** setup and return to the **MAIN SCREEN**.

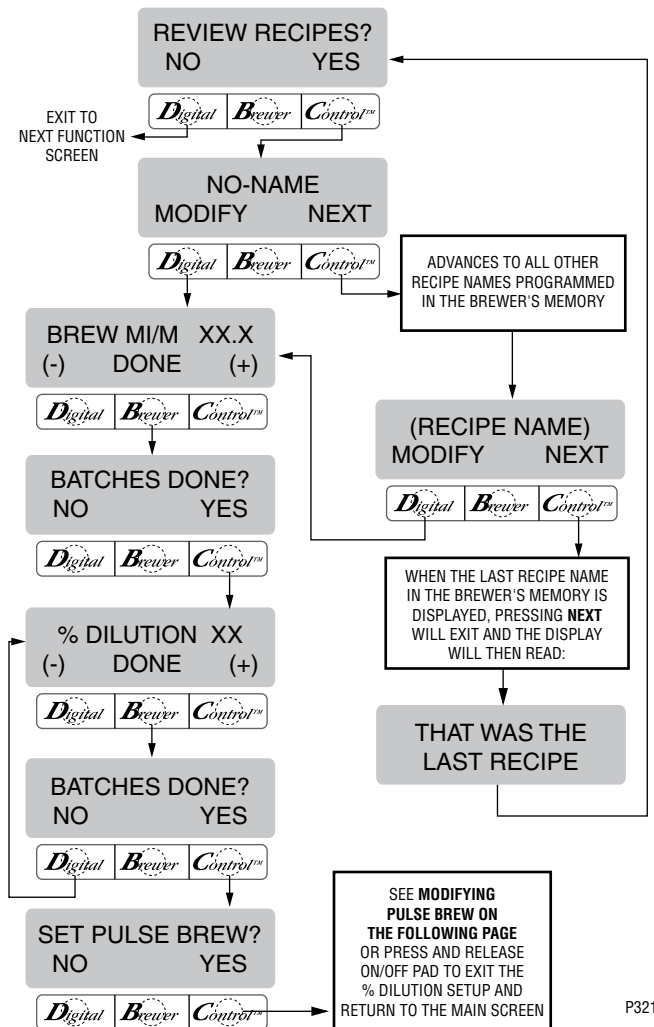

P3214

PROGRAMMING FUNCTIONS - LEVEL 2 (cont.)

SET PULSE BREW:

This function allows the operator to program the brewer to "pulse" the sprayhead flow on and off during a brew cycle (start and stop the flow of water out of the sprayhead). This feature allows the ability to "fine-tune" the brewer for specific flavor profiles. Pulse brewing can be set up for any and all batches.

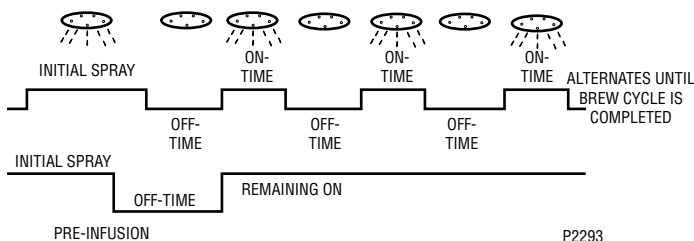

- 1st ON TIME** - This time is the duration from when the "BREW" pad is pressed to when the desired water level in the funnel is reached. (Soaking the grounds/tea)
- OFF-TIME** - This time is the duration from when the water in the funnel reaches the desired **ON TIME** level to when it drains out of the funnel to a desired lower level.
- LAST ON-TIME** - This time is the duration from when the water in the funnel drains down to the lower level to when it fills the funnel to a desired higher level. (Soaking the grounds/tea).

These three times can be set two different ways. The first is by observing the flow of water for on and off times. This is accomplished by utilizing the **SET BY EXAMPLE** screen and following the subsequent steps under that function.

The other allows the actual times to be entered for each of the settings. This is done by utilizing the **ENTER TIMES** screen and following the subsequent steps under that function.

Either of these methods can be used to set the pulse brew for each batch.

Modifying pulse brew:

Range: 1st on time - off to 4 minutes

Off time - off to 4 minutes

Last on time - off to 4 minutes

NOTE: If the brewer is already in the **SET PULSE BREW** screen, it is not necessary to follow steps 1 through 8 in this section, but proceed directly to step 9.

- Press and hold the **®** pad until the display reads **WARMER OFF**. Release the **®** pad. Press the **®** until the display reads **REVIEW RECIPES**.
- Press **YES** to proceed. The display should now read **NO NAME**, along with **MODIFY** and **NEXT**.
- Press and release **NEXT** to advance to the desired coffee name to be modified.
- Press and release **MODIFY**. The display should read **BREW MI/M**.
- Press and release **DONE**. The display should read **BATCHES DONE?**.
- Press and release **YES**. The display should now read **% DILUTION**.
- Press and release **DONE**. The display should read **BATCHES DONE?**.
- Press and release **YES**. The display should now read **SET PULSE BREW**.
- Press and release **YES**. The display should now read **SET BY EXAMPLE**.
- If setting Pulse brew **BY EXAMPLE** (brewing into a funnel) press **YES** and proceed with the setup instructions for *SETTING PULSE BREW - BY EXAMPLE*, on page 26.
- If setting Pulse brew by **ENTER TIMES** (entering known times) press **NO**. The display should read **ENTER TIMES**. Press and release **YES** and proceed with the setup instructions for *SETTING PULSE BREW - ENTER TIMES*, page 27.

PROGRAMMING FUNCTIONS - LEVEL 2 (cont.)

SET PULSE BREW (cont.)

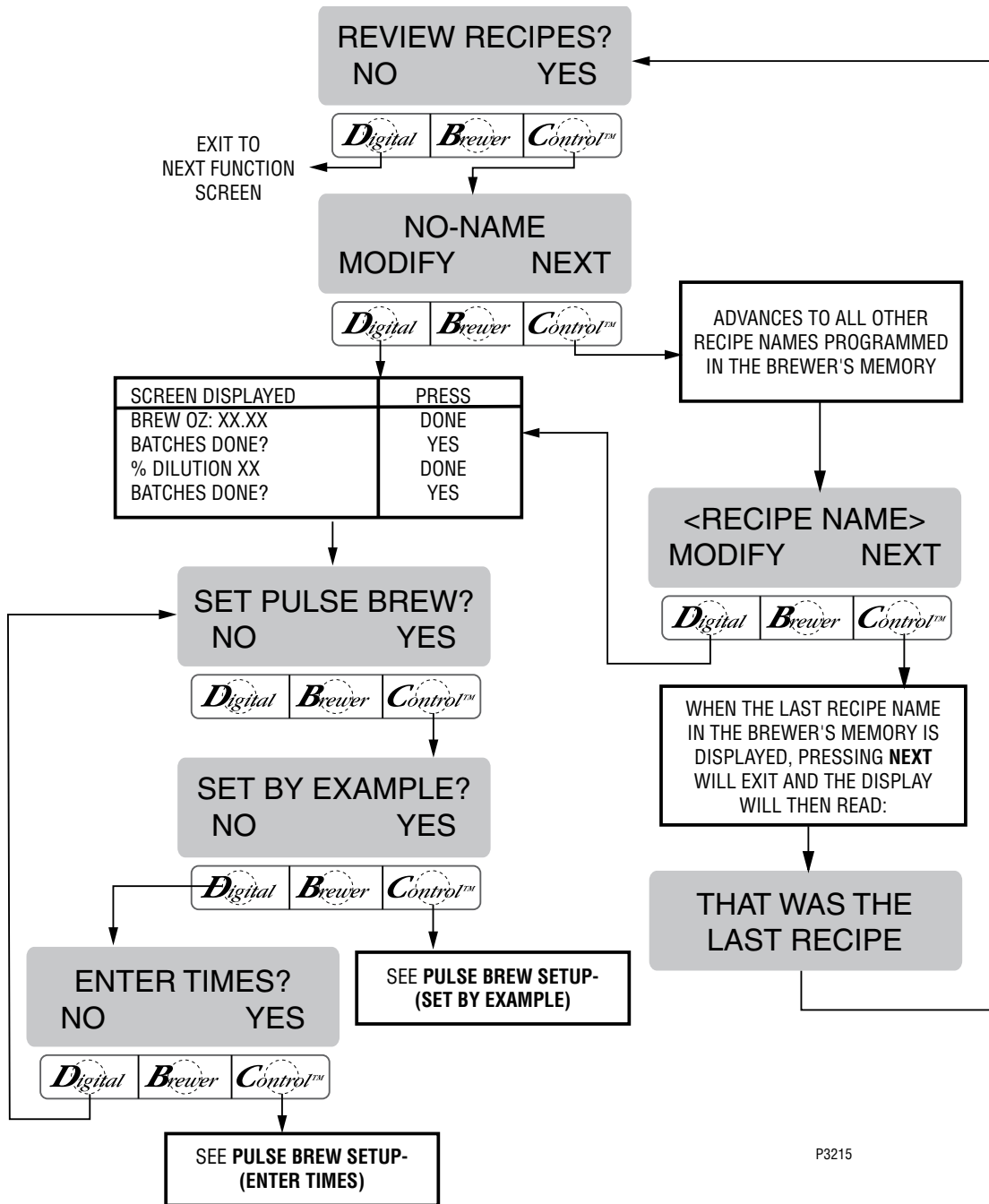

P3215

PROGRAMMING FUNCTIONS - LEVEL 2 (cont.)

Setting Pulse Brew - BY EXAMPLE:

1. This display should read **CONTAINER READY?**
Place a container under the sprayhead. Place a brew funnel containing a filter and grounds on top of the GPR server so that the spray and coffee bed can be viewed.
2. Choose the batch size to be set by pressing the pad next to the indicator light on the left brew side. The batch size indicator selected will be flashing.
3. If everything is in place, press YES in the **CONTAINER READY?** screen. The display should read **PRESS BREW TO SET 1ST ON TIME.** (a)
4. Press and release the "BREW" pad. The brew water will start to flow into the funnel and the water level will rise. (b)
5. Watch the flow of water. When it reaches the desired level in the funnel, press and release the "BREW" pad again to end the **1ST ON TIME.** (c)
6. The spray will stop and the brew funnel will start to empty. When the water level in the funnel drains to the desired level, press "BREW" again to end the **OFF-TIME.** This also begins the spray of water for the final setting. (d)
7. The brew water will begin again and the water level in the funnel will rise. Watch the flow of water. When it reaches the desired level, press "BREW" to end the **LAST ON TIME.** (e)
8. The display should now show the 1st, off and last times for the batch size just programmed. After a 5 second delay, the display will read **BATCHES DONE?** (f and g)
9. If other batches need to be modified, press **NO**. The display will go back to **SET BY EXAMPLE**. Press **YES**, then press a different batch size pad and repeat steps 1 through 8. Repeat until all the desired batch sizes are set for the left side. (g)
10. When finished press **YES** in **BATCHES DONE?**. The display will then read **SET PREINFUSION**. Another alternative is to press the "ON/OFF/LOWER" pad located on the front panel of the brewer to exit **SET PULSE BREW** and return to the **MAIN SCREEN**.

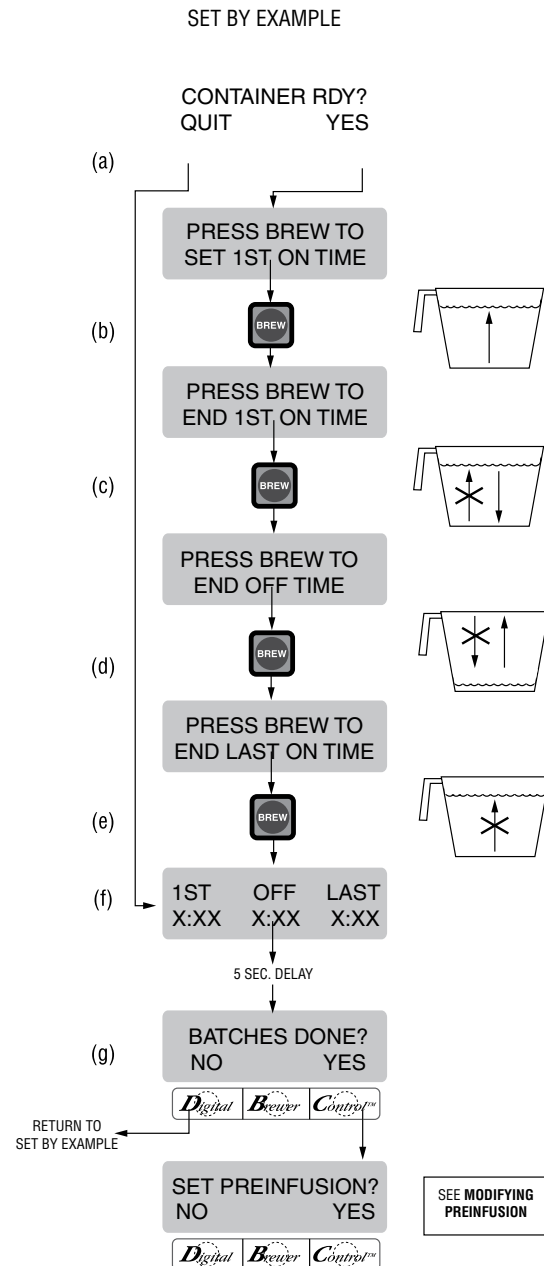

P3217

NOTE: Pressing **Ⓜ** before reaching the final setting screen exits the setup and retains the old values.

PROGRAMMING FUNCTIONS - LEVEL 2 (cont.)

Setting Pulse Brew - ENTER TIMES:

NOTE: No water should flow from the brewer during this set-up process.

1. This display should read **1ST ON TIME X:XX**. Choose the batch size to be set by pressing the pad next to the indicator light on the front panel. The batch size indicator selected will be flashing.
2. Adjust the **1ST ON TIME** using (-) and (+). When finished, press **DONE**. **(a)**
3. The display will now read **OFF TIME X:XX**. Adjust the **OFF TIME** using (-) and (+). When finished, press **DONE**. **(b)**
4. The display will now read **LAST ON TIME X:XX**. Adjust the **LAST ON TIME** using (-) and (+). When finished, press **DONE**. **(c)**
5. The display will show the three times just entered for that batch size. After a 5 second delay, the display will read **BATCHES DONE?(d and e)**

6. If other batch sizes need to be modified, press **NO**. The display will then read **SET BY EXAMPLE**.
7. In that screen, press **NO**. The display should now read **ENTER TIMES**.
8. Press **YES** in this screen, then press a different batch size pad and repeat steps 2 through 4. Repeat until all the desired batch sizes are set for the left side.
9. When finished press **YES** in **BATCHES DONE?**. The display will then read **SET PREINFUSION**. Another alternative is to press the "ON/OFF/LOWER" pad located on the front panel of the brewer to exit **SET PULSE BREW** and return to the **MAIN SCREEN**.

NOTE: Pressing **®** before reaching the final setting screen exits the setup and retains the old values.

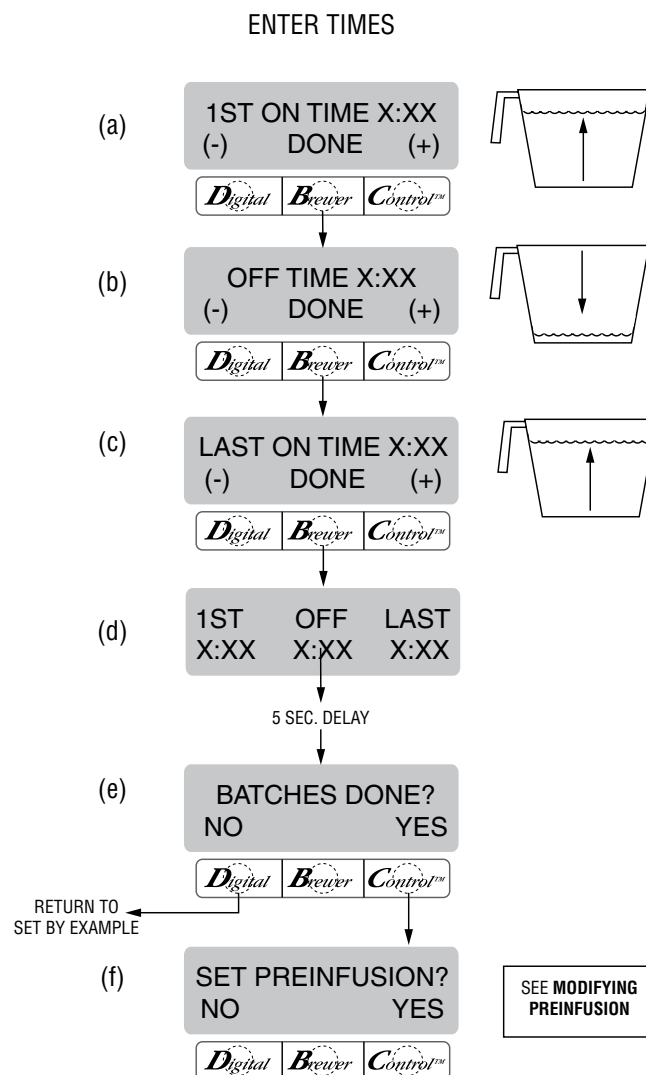

P3218

PROGRAMMING FUNCTIONS - LEVEL 2 (cont.)

SET PREINFUSION

This function allows the operator to set an initial soaking of the grounds/tea and a delay time, before the complete brew cycle starts.

Procedure for Modifying preinfusion times:

Range: On time - off to 4 minutes

Off time - off to 4 minutes for all batch sizes

NOTE: If the brewer is already in the **SET PREINFUSION** screen, it is not necessary to follow steps 1 through 9 in this section, but proceed directly to step 10.

1. Press and hold the **Ⓜ** pad until the display reads **WARMER OFF**. Release the **Ⓜ** pad. Press the **Ⓜ** until the display reads **REVIEW RECIPES**.
2. Press **YES** to proceed. The display should now read **NO NAME**, along with **MODIFY** and **NEXT**.
3. Press and release **NEXT** to advance to the desired coffee name to be modified.
4. Press and release **MODIFY**. The display should read **BREW MI/M**.
5. Press and release **DONE**. The display should read **BATCHES DONE?**.
6. Press and release **YES**. The display should now read **% DILUTION**.
7. Press and release **DONE**. The display should read **BATCHES DONE?**.
8. Press and release **YES**. The display should now read **SET PULSE BREW**.
9. Press and release **NO**. The display should now read **SET PREINFUSION**.
10. Press **YES** to proceed. The display should now read **ON TIME** and a batch light will be blinking.
11. Using **(-)** and **(+)**, set the amount of time the brew water will initially **presoak** the grounds for that particular batch size.
12. When finished, press another batch size and repeat until all three batch sizes are set.
13. When finished, press **DONE**. The display should now read **OFF TIME** and a batch light will be blinking.
14. Using **(-)** and **(+)**, set the amount of time the brew cycle will delay (after the presoak cycle shuts off) before resuming brewing.
15. When finished, press another batch size and repeat until all three batch sizes are set.

16. When finished, press **DONE**. The display will show the **ON** and **OFF TIMES** that were entered for a particular batch size.
17. After a 5 second delay, the display should read **BATCHES DONE?**. If all batches are not complete, press **NO** in order to return to **SET PREINFUSION**, and repeat steps 10 through 14.
18. If all batches are done, press **YES**. This will advance to the next function, **SET DRIP TIME**. Another alternative is to press the "ON/OFF/LOWER" pad located on the front panel of the brewer to exit **SET PULSE BREW** and return to the **MAIN SCREEN**.

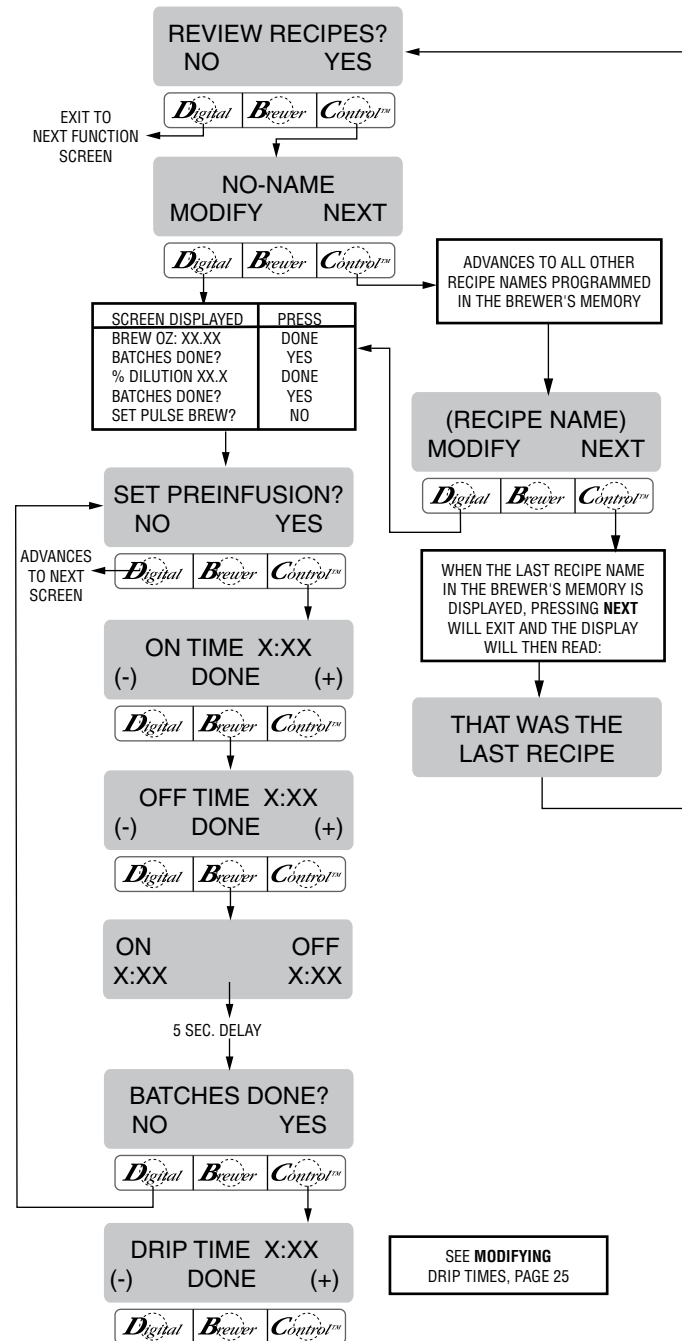

PROGRAMMING FUNCTIONS - LEVEL 2 (cont.)

DRIP TIME

This function allows the setting of a period of time at the end of a brew cycle to ensure that liquid has emptied out of the funnel prior to returning to **READY TO BREW**.

Procedure to modify drip times:

Range: OFF to 10 minutes for all batch sizes.

NOTE: If the brewer is already in the **DRIP TIMES** screen, it is not necessary to follow steps 1 through 10 in this section, but proceed directly to step 11.

1. Press and hold the **Ⓜ** pad until the display reads **WARMER OFF**. Release the **Ⓜ** pad. Press the **Ⓜ** until the display reads **REVIEW RECIPES**.
2. Press **YES** to proceed. The display should now read **NO NAME**, along with **MODIFY** and **NEXT**.
3. Press and release **NEXT** to advance to the desired coffee name to be modified.
4. Press and release **MODIFY**. The display should read **BREW MI/M**.
5. Press and release **DONE**. The display should read **BATCHES DONE?**.
6. Press and release **YES**. The display should now read **% DILUTION**.
7. Press and release **DONE**. The display should read **BATCHES DONE?**.
8. Press and release **YES**. The display should now read **SET PULSE BREW**.
9. Press and release **NO**. The display should now read **SET PREINFUSION**.
10. Press and release **NO**. The display should now read **DRIP TIME**, along with either the word **OFF**, or a time will be showing. A batch light should also be blinking.
11. Using the **(-)** and **(+)**, set the amount of time from when the brew solenoid shuts off to when drip-out occurs for that batch size.

NOTE: Set to **OFF** to disable this function. To set to **OFF**, press and release **(-)** until **OFF** is displayed.

12. When finished, press another batch size and repeat step 11 until all batches are set.
13. When finished, press **DONE**. The display should read **BATCHES DONE?**
14. If all batch sizes are set correctly, press **YES**. The screen should show the name of the coffee flavor being programmed (modified) along with **SETUP COMPLETE**.
15. After a 5 second delay, the display will advance to the next coffee name in the brewer's memory. If no other coffee names are present, the display will read **THAT WAS THE LAST RECIPE**, and return to the **REVIEW RECIPES** screen.

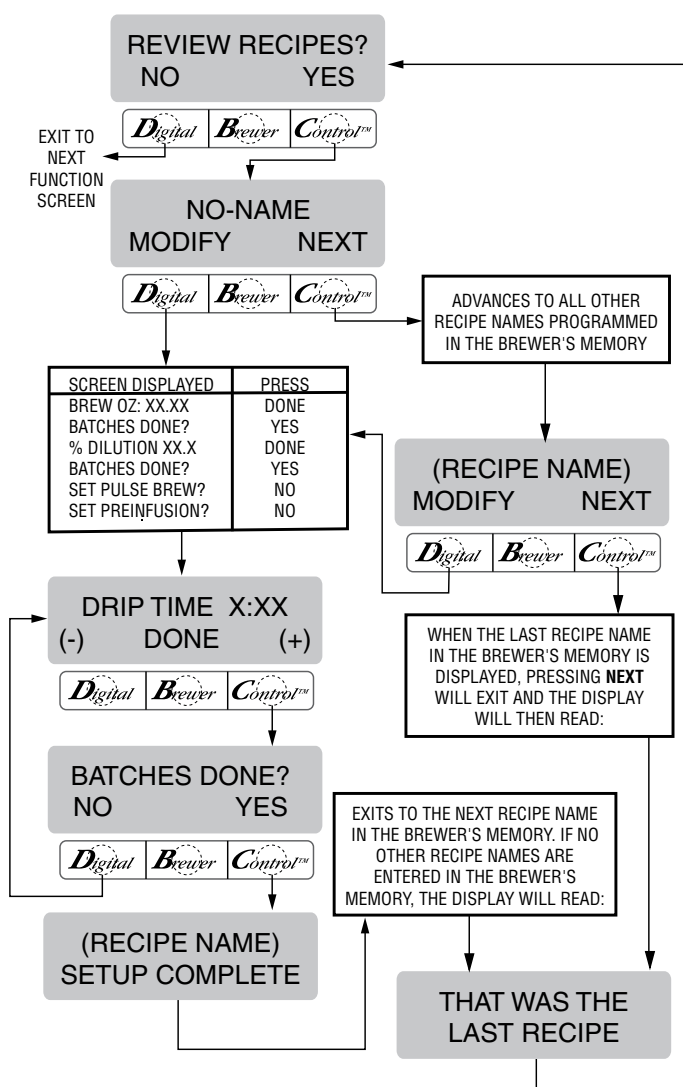

PROGRAMMING FUNCTIONS - LEVEL 2 (cont.)

ENABLE ADS?

This function allows the operator to choose whether or not to display the advertising message that was entered into the brewer with an **AD CARD**. This message will be displayed when the brewer is not in use.

ENABLE ADS?
NO DONE YES



Procedure to Enable/Disable Ads:

1. Press and hold the **Ⓜ** pad until the display reads **WARMER OFF**. Release the **Ⓜ**. Press and release the **Ⓜ** until the display reads **ENABLE ADS**. The **YES** or **NO** will be flashing to indicate the current selection.
2. Press and release the **NO** pad to disable this function (no ads will be displayed on the screen), or;
3. Press and release the **YES** pad to enable this function (ads will be displayed on screen).
4. When finished, press and release **DONE** to save the new setting, exit the **ENABLE ADS** function and advance to the next function screen, **SET TEMP**. Another alternative is to press the "ON/OFF/LOWER" pad located on the front switch panel to exit the **ENABLE ADS** function and return to the **MAIN SCREEN**.

SET TEMP - Range: 85°C (185°F) to 96°C (205°F)

This function allows the operator to set the brew water temperature in the tank. It also sets the hot water faucet dispense temperature.

SET TEMP: XXX°
(-) DONE (+)



Procedure to set brew temperature:

1. Press and hold the **Ⓜ** pad until the display reads **WARMER OFF**. Release button. Press and release the **Ⓜ** until the display reads **SET TEMP**.

2. To adjust the brew temperature, press **(-)** to decrease or **(+)** to increase the brew temperature.
3. When finished, press and release **DONE** to save the new setting, exit the **SET TEMP** function and advance to the next function screen, **SET READY**. Another alternative is to press the "ON/OFF/LOWER" pad located on the front switch panel to exit the **SET TEMP** function and return to the **MAIN SCREEN**.

SET READY - Range: 85°C (185°F) to 95°C (203°F)

This function allows the operator to set the minimum temperature allowable to start a brew cycle. The range can be from 85°C (185°F) to within 1°C (2°F) of the **SET TEMP**. The water must be at the **SET READY** temperature or higher for the display to indicate **READY TO BREW**. If brew lockout is enabled, the brewing process will not start below this **READY** temperature.

NOTE: The upper limit is the water temperature control setting minus 1°C (2°F).

READY TEMP: XXX°
(-) DONE (+)



Procedure to set ready temperature:

1. Press and hold the **Ⓜ** pad until the display reads **WARMER OFF**. Release the **Ⓜ** pad. Press and release the **Ⓜ** pad until the display reads **SET READY**.
2. To adjust the ready temperature, press the **(-)** button to decrease, or **(+)** to increase the ready temperature.
3. When finished, press and release **DONE** to save the new setting, exit the **SET READY** function and advance to the next function screen, **REFILL**. Another alternative is to press the "ON/OFF/LOWER" pad located on the front switch panel to exit the **SET READY** function and return to the **MAIN SCREEN**.

PROGRAMMING FUNCTIONS - LEVEL 2 (cont.)

REFILL - Range: 20 to 230

This function allows the operator to adjust the sensitivity of the refill circuit. This is mainly a troubleshooting feature. Water in different geographical locations can have different conductivities. By adjusting the sensitivity of the refill circuit, this will allow the brewer to operate under various water conditions.

XXX REFILL -> XXX
(-) DONE (+)



Procedure to set the sensitivity threshold of the refill circuit:

NOTE: Make sure the water in the tank is touching the refill probe.

1. Press and hold the **Ⓡ** until the display reads **WARMER OFF**. Release the **Ⓡ**. Press and release the **Ⓡ** pad until the display reads **REFILL** and shows a number on both sides of the word.
2. To adjust the threshold setting, press **(-)** to decrease, or **(+)** to increase the setting.

NOTE: Always make sure that the number on the right is larger than the number on the left when water is in contact with the refill probe in the tank.

3. When finished, press and release **DONE**. This saves the new setting and advances to the next function screen, **SPRAY MI/M**. Another alternative is to press the "ON/OFF/LOWER" pad located on the front switch panel to exit **REFILL** and return to the **MAIN SCREEN**.

SPRAY MI/M

This function allows the operator to view or to enter the actual flow rate coming out of the sprayhead. This is **NOT** used to change the actual flow rate, but to tell the internal controller how fast the water is flowing. The unit of measure is ounces per minute. (MI/M)

SPRAY MI/M: XX.X
(-) DONE (+)



Procedure to adjust the flow rate setting:

1. Press and hold the **Ⓡ** pad until the display reads **WARMER OFF**. Release the **Ⓡ**. Press and release the **Ⓡ** pad until the display reads **SPRAY MI/M**. The number represents what the brewer thinks is the flow rate of the sprayhead valve in ounces per minute.
2. If the actual flow rate of the sprayhead valve is known, but is different than the number on the display, use the **(-)** and **(+)** pads to enter the correct flow rate in ounces per minute.
3. When finished, press and release **DONE**. This saves the new setting and advances to the next function screen, **DILUTE MO/M**. Another alternative is to press the "ON/OFF/LOWER" pad located on the switch panel to exit **SPRAY MI/M** function and return to the **MAIN SCREEN**.

DILUTE MI/M

This function allows the operator to view or to enter the actual flow rate coming out of the dilution nozzle. This is **NOT** used to change the actual flow rate, but to tell the internal controller how fast the water is flowing. The unit of measure is ounces per minute.

DILUTE MI/M: XX.X
(-) DONE (+)



Procedure to adjust the flow rate setting:

1. Press and hold the **Ⓡ** pad until the display reads **WARMER OFF**. Release the **Ⓡ**. Press and release the **Ⓡ** pad until the display reads **DILUTE MI/M**. The number represents what the brewer thinks is the flow rate of the dilution valve in ounces per minute.
2. If the actual flow rate of the dilution valve is known, but is different than the number on the display, use the **(-)** and **(+)** pads to enter the correct flow rate in ounces per minute.
3. When finished, press and release the **DONE** pad. This saves the new setting and advances to the next function screen, **CALIBRATE FLOW**. Another alternative is to press the "ON/OFF/LOWER" pad located on the front switch panel to exit the **DILUTE MI/M** function and return to the **MAIN SCREEN**.

PROGRAMMING FUNCTIONS - LEVEL 2 (cont.)

CALIBRATE FLOW

This function allows the operator to enter the actual flow rate of the sprayhead and the dilution by dispensing both separately for one minute. The volumes are then entered in milliliters per minute. (MI/M)

Procedures to calibrate the sprayhead flow rate:

1. Place a container, accurately graduated in milliliters, and with a minimum capacity of 1800 milliliters, beneath the funnel on the brewer.
2. Press and hold the **®** pad until the display reads **WARMER OFF**. Release the **®** pad. Press and release the **®** pad until the display reads **CALIBRATE FLOW**.
3. Press and release **YES** to advance to the **SPRAYHEAD CAL?** function screen. (Pressing **NO** in the **CALIBRATE FLOW** screen will advance to the next function screen, **BREW COUNTERS**).
4. Press and release the **YES** pad. The display should read **CONTAINER READY?** If the container is under the funnel, press **YES**. The display should read **CALIBRATE SPRAY .. PRESS BREW TO START**.
5. Press and release the "BREW" pad. The display should read **CALIBRATE SPRAY .. 60 SEC TO FINISH**. The 60 second timer on the display will count down to zero. When the counter reaches zero, the display will change to **ENTER MI.**, along with a number measured in ounces per minute.
6. Measure the amount of water in the container and using the **(-)** or **(+)** pads, adjust the amount on the display to match the amount in the container. Then press **DONE**.
7. The display should now read **NEW SPRAY FLOW**, along with the correct flow rate of the sprayhead in ounces per minute. After about 5 seconds, the display will return to the **CALIBRATE FLOW** screen.
8. To exit the **CALIBRATE FLOW** program, press **NO** to advance to the next function screen, or press the "ON/OFF/LOWER" pad located on the front switch panel to exit the **CALIBRATE FLOW** function and return to the **MAIN SCREEN**.

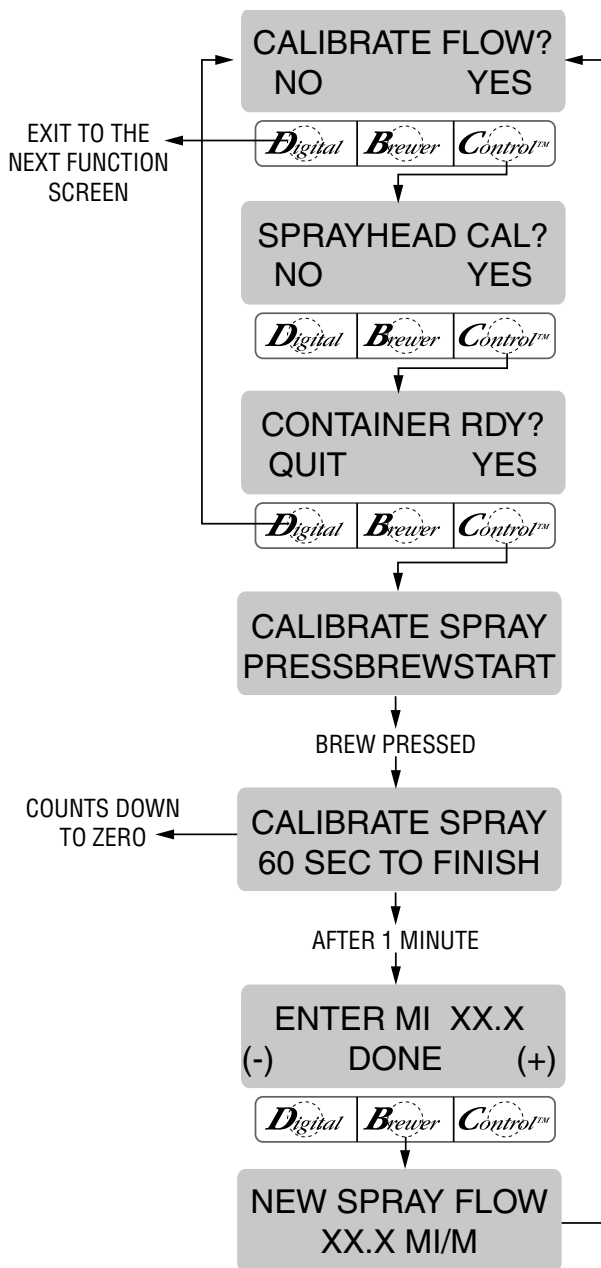

P3223

PROGRAMMING FUNCTIONS - LEVEL 2 (cont.)

CALIBRATE FLOW (cont.)

Procedures to calibrate the dilution flow rate:

1. Place a container, accurately graduated in ounces, and with a minimum capacity of 1800 milliliters, below the funnel on the brewer.
2. Press and hold the **Ⓜ** pad until the display reads **WARMER OFF**. Release the **Ⓜ** pad. Press and release the **Ⓜ** pad until the display reads **CALIBRATE FLOW**.
3. Press and release **YES** to advance to the **SPRAYHEAD CAL?** function screen. (Pressing **NO** in the **CALIBRATE FLOW** screen will advance to the next function screen, **BREW COUNTERS**).
4. Press and release **NO** to advance to the **DILUTION CAL?** screen.
5. Press and release the **YES** pad. The display should read **CONTAINER READY?** If the container is under the funnel, press **YES**. The display should read **CALIBRATE DILUTE ... PRESS BREW TO START**.
6. Press and release the "BREW" pad. The display should read **CALIBRATE DILUTE ... 60 SEC TO FINISH**. The 60 second timer on the display will count down to zero. When the counter reaches zero, the display will change to **ENTER MI.**, along with a number measured in milliliters per minute.
7. Measure the amount of water in the container, and using **(-)** or **(+)**, adjust the amount on the display to match the amount in the container. Then press **DONE**.
8. The display should now read **NEW DILUTE FLOW**, along with the correct flow rate of the dilution in milliliters per minute. After about 5 seconds, the display will return to the **CALIBRATE FLOW** screen.
9. To exit the **CALIBRATE FLOW** function, press and release **NO** to advance to the next function screen, or press the "ON/OFF/LOWER" pad located on the front switch panel to exit the **CALIBRATE FLOW** function and return to the **MAIN SCREEN**.



P3224

PROGRAMMING FUNCTIONS - LEVEL 2 (cont.)

BREW COUNTERS

This function allows the operator to track the number of brew cycles completed. There is one resettable counter, and one life counter that is not resettable.

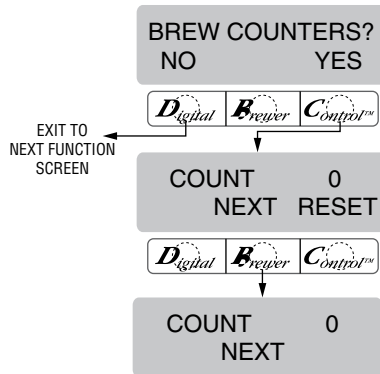

P3225

Procedures to view/reset the brew counters:

1. Press and hold the **Ⓜ** pad until the display reads **WARMER OFF**. Release the **Ⓜ**. Press and release the **Ⓜ** pad until the display reads **BREW COUNTERS**.
2. Pressing **NO** in this screen will advance to the next function. Press **YES** to view the first brew counter. This number represents the brew cycles initiated since that counter was last reset.
3. To reset the resettable counter to zero press and release **RESET** when viewing that particular counter's screen.
4. To advance to the other counter, press and release **NEXT**. This will advance to total brews (non-resettable).
5. When finished, press **NEXT** until the display reads **BREW COUNTERS**. Press and release **NO** to advance to the next function screen, or press the "ON/OFF/LOWER" pad on the front switch panel to exit the **BREW COUNTERS** function and return to the **MAIN SCREEN**.

FUNNEL LOCKOUT

This function allows the operator to prevent the start of a brew cycle if a Smart Funnel is not positioned correctly in the funnel rails.

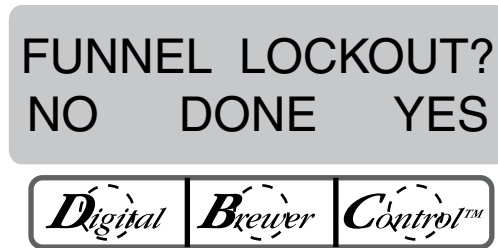

Procedure to set funnel detect:

1. Press and hold the **Ⓜ** pad until the display reads **WARMER OFF**. Release the **Ⓜ**. Press and release the **Ⓜ** pad until the display reads **FUNNEL LOCKOUT**.
2. **NO** or **YES** should be flashing to indicate the current setting.
3. Select **YES** to prevent brewing if a Smart Funnel is not correctly situated in the rails. If this function is activated and a brew cycle is attempted with the funnel not properly situated, the display will read, **FUNNEL NOT IN PLACE**, until one is in place.
4. Select **NO** to allow brewing without a Smart Funnel in place. This is selected when brewing with a funnel other than a Smart Funnel (a regular brew funnel).
5. When finished, press and release **DONE**. This will retain the changes, exit this function screen and advance to the next. Another alternative is to press the "ON/OFF/LOWER" pad located on the front switch panel to exit the **FUNNEL LOCKOUT** and return to the **MAIN SCREEN**.

PROGRAMMING FUNCTIONS - LEVEL 2 (cont.)

SET UNITS

This function allows the operator to change the units of measure from **METRIC** to **ENGLISH**.

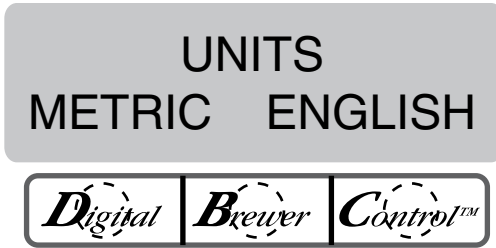

Procedures to set UNITS:

1. Press and hold the **Ⓜ** pad until the display reads **WARMER OFF**. Release the **Ⓜ**. Press and release the **Ⓜ** pad until the display reads **UNITS**.
2. The **METRIC** or **ENGLISH** flashes to indicate the current selection.
3. Changing the current selection will cancel all previously entered recipes and return to **FACTORY DEFAULT** values.
4. When finished, press and release **DONE**. This will save the new setting, exit the function screen and advance to the next. Another alternative is to press the "ON/OFF/LOWER" pad located on the front switch panel to exit the **UNITS** function and return to the **MAIN SCREEN**.

PROGRAMMING FUNCTIONS - LEVEL 2 (cont.)

SERVICE TOOLS

This function allows the testing of individual components and the ability to check switches for proper function. This function also tests the funnel sensor coil's frequency (diagnostic tool for troubleshooting purposes only).

Testing individual components (outputs):

This will allow the operator to test the operation of individual components and outputs of the brewer. The components that can be individually tested are as follows:

Brew Valve
 Dilution Valve
 Funnel Lock (Optional)
 Warmer
 Refill Valve
 Tank Heaters

Procedure to test components (outputs):

1. Place brew funnels into rails on the brewer.
2. Place a server beneath the brew funnel.

3. Press and hold the **Ⓢ** pad until the display reads **WARMER OFF**. Release the **Ⓢ** pad. Continue pressing and releasing the pad until **SERVICE TOOLS** appears.
4. Press **YES** to run tests on various components and outputs within the brewer. Pressing **NO** will exit this function and advance to the next function screen.
5. The display should read **TEST OUTPUTS**.
6. Press and release **YES**. The display should read **BREW VALVE**.
7. To test **BREW VALVE**, press **ON**. If the brew valve is functional, water should run from the brewer.
8. Press **OFF** to end flow of water.
9. Press **NEXT** to advance to the next component to be tested.

NOTE: To bypass testing any component, press **NEXT** to advance to the next one, without testing the previous component.

10. To test **DILUTION VALVE**, press **ON**. If the dilution valve is functional, water should run from the brew dilution port at the left of the sprayhead.
11. Press **OFF** to end flow of water.
12. Press **NEXT** to advance to the next component to be tested.
13. To test **FUNNEL LOCK**, press **ON**. If the funnel lock is functional, the lock will come down to hold the funnel in place.
14. Press **OFF** to retract the funnel lock.

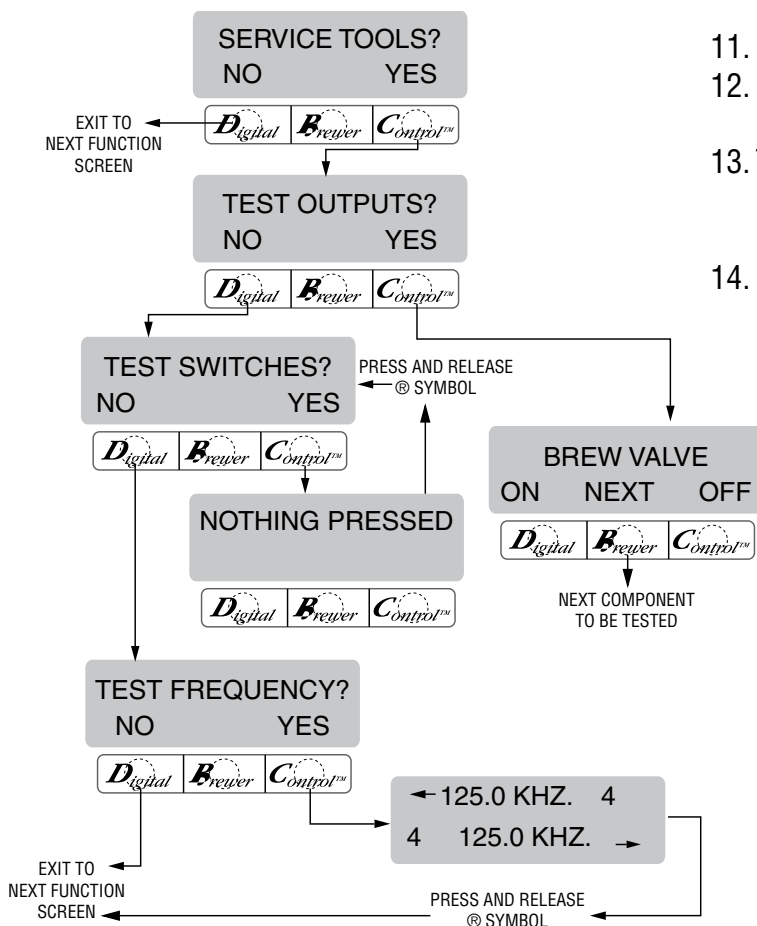

P3228

PROGRAMMING FUNCTIONS - LEVEL 2 (cont.)

SERVICE TOOLS (cont.)

15. Press **NEXT** to advance to the next component to be tested.
16. To test **WARMER**, press **ON**. If the warmer is functional, the light on the lower right corner of the warmer switch will illuminate.
17. Press **OFF** to end testing of server.
18. Press **NEXT** to advance to the next component to be tested.
19. To test **REFILL VALVE**, press **ON**. If the refill valve is functional, the sound of the valve operating will be heard.
20. Press **OFF** to end testing of refill valve.
21. Press **NEXT** to advance to the next component to be tested.
22. To test **TANK HEATER**, connect a voltmeter to the tank heater to check for voltage.
23. Press **ON**. The correct voltage should be present at the heater terminals.
24. Press **OFF** to end testing of the tank heaters.

NOTE: The tank heater will automatically turn off if left on too long.

25. After testing the tank heater, press **NEXT** to advance to the next test.
26. Press **NEXT** to return to **TEST OUTPUTS**.
27. To exit **SERVICE TOOLS**, press the "ON/OFF/LOWER" pad located on the front switch panel. This will return to the **MAIN SCREEN**.

Procedure to test switches:

This function allows the operator to test the operation of the individual switches on the front panel.

1. Place brew funnel into rails on the brewer.
2. Place a server beneath the brew funnel.
3. Press and hold the Ⓜ pad until the display reads **WARMER OFF**. Release the Ⓜ pad. Continue pressing and releasing the Ⓜ pad until **SERVICE TOOLS** appears.
4. Press **YES** to run tests on various components and outputs within the brewer. (Pressing **NO** will exit this function and advance to the next function screen.)
5. The display should read **TEST OUTPUTS**.

6. In **TEST OUTPUTS** screen, press **NO**. This advances to **TEST SWITCHES**.
7. Pressing **NO** in this screen will advance to the next function. Press **YES** in the **TEST SWITCHES** screen to test the switches. The display will read **NOTHING PRESSED**.
8. From this screen, press any of the switches on the front of the brewer. While the switch is pressed, the display shows the name of that switch. If the name does not appear, or if it remains after the switch has been released, the switch is defective. Each switch can be tested in this manner.
9. After all switches have been tested, press the Ⓜ pad located on the front switch panel. This will exit **TEST SWITCHES** and return to the **MAIN SCREEN**.

Procedures to test coil frequency:

1. Place brew funnel into rails of the brewer.
2. Place a server beneath the brew funnel.
3. Press and hold the Ⓜ pad until the display reads **WARMER OFF**. Release the Ⓜ pad. Continue pressing and releasing the Ⓜ pad until **SERVICE TOOLS** appears.
4. Pressing **NO** will exit this function and advance to the next function screen. Press **YES** to run tests on various components and outputs within the brewer.
5. The display should read **TEST OUTPUTS**.
6. In **TEST OUTPUTS** screen, press **NO**. Continue to press and release **NO** until the display reads **TEST FREQUENCY**.
7. Press and release **YES**. The display will show the frequency of the sensor coil circuits. This is for diagnostic service use when troubleshooting this circuit.
8. After the coils have been tested, press and release the "ON/OFF/LOWER" pad located on the front switch panel. This will exit the **TEST FREQUENCY** function and return to the **MAIN SCREEN**.

NOTE: If the operator wishes to test more than one function in the **SERVICE TOOLS** section (outputs, switches, warmers, or coil frequency), it is not necessary to exit the program. Use the flow chart for **SERVICE TOOLS** to navigate to a particular function.

PROGRAMMING FUNCTIONS - LEVEL 2 (cont.)

FACTORY DEFAULTS

This function allows the operator to erase **all** of the previously entered recipes and ad messages. Factory-set default values will replace **all** previous settings.

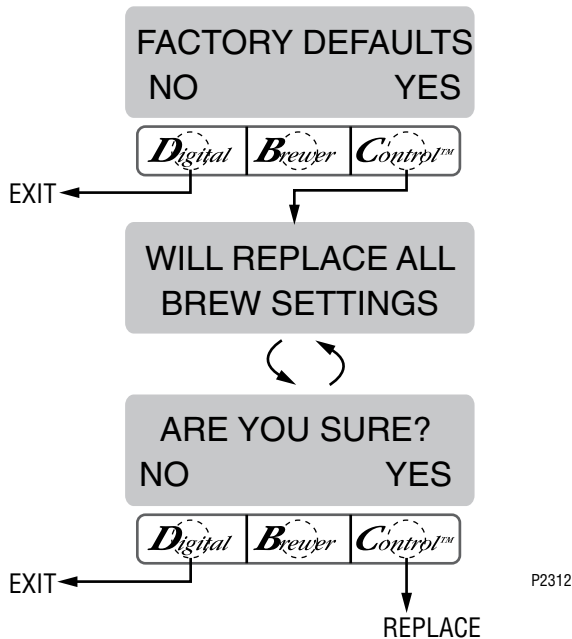

Procedure to set factory defaults:

1. Press and hold the $\text{\textcircled{R}}$ pad until **WARMER OFF** appears. Release the $\text{\textcircled{R}}$ pad. Press and release $\text{\textcircled{R}}$ until the display reads **FACTORY DEFAULTS**.
2. Pressing **NO** in this screen will revert to the **MAIN SCREEN**. Press **YES** to replace the defaults. This advances to **WILL REPLACE ALL BREWING SETTINGS**. This screen will alternate with **ARE YOU SURE?**
3. Pressing **NO** in the confirmation screen will revert to **MAIN SCREEN**, without resetting the brewing setups to the defaults. Press **YES** to load the defaults. This will then revert to the **MAIN SCREEN**, and the factory default values will replace **all** previously entered values. It will NOT reset the summation Brew counter.

FACTORY DEFAULT VALUES

Brew Lockout NO

DEFAULT (NO NAME) SETTINGS:

Iced Coffee

BREW VOLUME 1800 mL
 DILUTION VOLUME 0 mL
 PULSE BREW TIME None
 PREINFUSION TIME 1st 0:53, OFF 0:45
 DRIP OUT TIME 1:00

Hot Coffee

	Half Batch	Full Batch
BREW VOLUMES	900 mL	1800 mL
DILUTION VOLUMES	0 mL	0 mL
PULSE BREW TIMES	None	None
PREINFUSION TIMES	1st 0:15, Off 1:00	None
DRIP OUT TIMES	0:30	0:45

Iced Tea

BREW VOLUMES 2800 mL
 DILUTION PERCENTAGE 53%
 PULSE BREW TIMES None
 PREINFUSION TIMES None
 DRIP OUT TIMES 0:45

ENABLE ADS YES

BREW TEMPERATURE 93°C (200°F)

READY TEMPERATURE 91°C (195°F)

REFILL 155

SPRAY (MI/MINUTE) 1160

DILUTE (MI/MINUTE) 730

FUNNEL LOCKOUT NO

UNITS METRIC

TROUBLESHOOTING

A troubleshooting guide is provided to suggest probable causes and remedies for the most likely problems encountered. If the problem remains after exhausting the troubleshooting steps, contact the Bunn-O-Matic Technical Service Department.

- Inspection, testing, and repair of electrical equipment should be performed only by qualified service personnel.
- All electronic components have 120 - 240 volt ac and low voltage dc potential on their terminals. Shorting of terminals or the application of external voltages may result in board failure.
- Intermittent operation of electronic circuit boards is unlikely. Board failure will normally be permanent. If an intermittent condition is encountered, the cause will likely be a switch contact or a loose connection at a terminal or crimp.
- Solenoid removal requires interrupting the water supply to the valve. Damage may result if solenoids are energized for more than ten minutes without a supply of water.
- The use of two wrenches is recommended whenever plumbing fittings are tightened or loosened. This will help avoid twists and kinks in the tubing.
- Make certain that all plumbing connections are sealed and electrical connections tight and isolated.
- This brewer is heated at all times. Keep away from combustibles.

WARNING

- Exercise extreme caution when servicing electrical equipment.
- Disconnect the brewer from the power source when servicing, except when electrical tests are specified.
- Follow recommended service procedures.
- Replace all protective shields or safety notices.

Screen Displayed

Possible Cause

Troubleshooting Procedure

OVERFLOW CUP
FULL. EMPTY CUP

1. Overflow cup is full of water.

Empty cup

TROUBLESHOOTING (cont.)

Screen Displayed

NO FUNNEL
PRESENT

Possible Cause

1. **SMART FUNNEL** not fully inserted into the funnel rails.
2. Not using a **SMART FUNNEL**, and the **FUNNEL LOCKOUT** function is activated (on).

Troubleshooting Procedure

Position the funnel so that the sensor is directly beneath the sensor coil on the brewer.

Disable the **FUNNEL LOCKOUT** function. See page 30 for procedure.

TEMPERATURE
TOO LOW

1. Water temperature in the tank does not meet the **SET READY TEMPERATURE**.

(a) Wait for the brewer to heat to the proper temperature.

(b) Disable the **BREW LOCKOUT** function. See page 10 for procedure.

CHECK FUNNEL
FOR FRESH COFFEE

1. Brew funnel was not removed after the previous brew cycle was finished.

Remove funnel, check contents, and insert back into the funnel rails.

OR

PRESS BREW
TO BREW ANYWAY

Press **BREW** to start a brew cycle without removing the funnel.

BREW STOPPED!
FUNNEL REMOVED?

1. Brew funnel was moved out of position after the brew cycle was started.

To resume brewing, correctly position the funnel and press **BREW** again. The brew cycle will resume from the point it was interrupted.

OR

TO FINISH:
PRESS BREW

Press **ON/OFF** to terminate the cycle.

TO CANCEL
PRESS ON/OFF

TROUBLESHOOTING (cont.)

Screen Displayed

BREW STOPPED!
IS SWITCH OFF?



TO FINISH:
PRESS BREW



TO CANCEL
PRESS ON/OFF

HEATING TIME
TOO LONG



CHECK HEATING
CIRCUIT

Possible Cause

1. **ON/OFF** switch was pressed after the brew cycle was started.

1. Tank Heater failure

2. Triac Failure

3. Control Board/Thermistor failure

Troubleshooting Procedure

To resume brewing, press BREW again. The brew cycle resumes from the point it was interrupted.

OR

Press **ON/OFF** to terminate the brew cycle.

Service Required

Service Required

Service Required

TROUBLESHOOTING (cont.)

Screen Displayed

Possible Cause

Troubleshooting Procedure

FILL TIME TOO
LONG



CHECK WATER
SUPPLY

1. Water shut off to brewer
2. Inlet Solenoid Valve failure
3. Control Board Failure

Check water supply shut-off
Service required
Service required

TEMP SENSOR
OUT OF RANGE



CHECK FOR BAD
CONNECTIONS

1. Temperature Sensor Probe wire(s) broken or not making connection.

Check wire and connection of both black and white wires of temperature probe.

TEMP SENSOR
OUT OF RANGE



CHECK WIRE FOR
SHORTS

1. Temperature Sensor Probe wire(s) shorted to housing, or to each other.

Check to confirm that wire(s) are not pinched between two surfaces or connected to each other.

TROUBLESHOOTING (cont.)

Problem	Possible Cause	Troubleshooting Procedure
Equipment will not operate.	1. No power or incorrect voltage.	Measure the voltage at the terminal block and confirm that it matches the voltage specified on the brewer data plate within +/- 10%.
Brew cycle will not start.	1. No water	Check plumbing and shut-off valves
	2. ON/OFF switch	Test the ON/OFF switch. Refer to the switch test procedures on page 37.
	3. Brew switch	Test the BREW switch. Refer to the switch test procedures on page 37.
	4. Brew Valve	Test the Brew valve. Refer to <i>Testing Individual Components</i> on page 37.
	5. Electronic Control Board	Substitute a control board known to be in good working order.
Automatic refill will not operate or display shows FILL TIME TOO LONG	1. No water	Check plumbing and shut-off valves.
	2. Water strainer/flow control (.750 GPM)	(A) Direction of flow arrow must be pointing towards direction of water flow. (B) Remove the strainer/flow control and check for obstructions. Clear or replace.

TROUBLESHOOTING (cont.)

Problem

Automatic refill will not operate or display shows FILL TIME TOO LONG (cont.)

Possible Cause

3. Refill Probe or Sensitivity Setting

Troubleshooting Procedure

Check the sensitivity setting. Refer to the *Refill* function on page 31. If the left three digit number is less than the right number, the machine “thinks” it is full and the refill valve should be off. If the left number is larger than the right, then the refill valve will automatically be turned on to fill the tank. The right number is the threshold setting and can be adjusted to compensate for extreme water conditions: very pure, low conductance water requires a higher setting, while high mineral content, high conductance water requires a lower setting. Note that the left number changes from a high value when water is NOT touching the refill probe to a low value when water IS touching the probe. For best operation, the right number should be set to a value midway between these low and high numbers. Before changing the setting, confirm that the refill probe is free of scale buildup and the connection to it is secure.

4. Refill Valve

Test the Refill valve. Refer to *Testing Individual Components* on page 36.

5. Overflow Protection Switch

When this condition occurs, the brewer will display OVERFLOW CUP FULL. EMPTY CUP. The reason for overfilling could be a defective refill valve, an incorrect sensitivity setting, (see above) or boiling.

6. Electronic Control Board

Substitute a control board known to be in good working order.

Water flows into tank continuously with power removed from brewer.

1. Refill valve

Foreign material lodged in valve, holding it in open state.

TROUBLESHOOTING (cont.)

Problem

Possible Cause

Troubleshooting Procedures

Water flows into tank continuously with power applied to brewer.

1. Refill Probe or Sensitivity Setting

Check the sensitivity setting. Refer to the *Refill* function on page 31. If the left three digit number is less than the right number, the machine “thinks” it is full and the refill valve should be off. If the left number is larger than the right, then the refill valve will automatically be turned on to fill the tank. The right number is the threshold setting and can be adjusted to compensate for extreme water conditions: very pure, low conductance water requires a higher setting, while high mineral content, high conductance water requires a lower setting. Note that the left number changes from a high value when water is NOT touching the refill probe to a low value when water IS touching the probe. For best operation, the right number should be set to a value midway between these low and high numbers. Before changing the setting, confirm that the refill probe is free of scale buildup and the connection to it is secure.

2. Electronic Control Board

Substitute a control board known to be in good working order.

Water will not heat or display shows HEATING TIME TOO LONG

1. Limit Thermostat

CAUTION - Do not eliminate or bypass limit thermostat. Use only replacement part #23717.0001.

Remove power from the brewer. Press reset button on limit thermostat. Then check for continuity through it.

2. Tank Heaters

Remove power from the brewer. Check for continuity through the tank heaters.

TROUBLESHOOTING (cont.)

Problem	Possible Cause	Troubleshooting Procedures
Spitting or unusual steaming from sprayhead or air vents. (Water too hot) (cont.)	3. Electronic control board	Perform the above procedure for testing triacs. If the voltage measured is very low or zero, then substitute a control board known to be in good working order.
Inconsistent beverage level in server.	1. Strainer/flow control (.750 GPM)	(A) Direction of flow arrow must be pointing towards the brewer. (B) Remove the strainer/flow control and check for obstructions. Clear or replace.
	2. Improper water pressure	Check operating water pressure to the brewer. It must be between 20 and 90 psi (138 and 620 kPa).
	3. Brew Valve	Test the Brew Valve. Refer to <i>Testing Individual Components</i> on page 36. Turn the valve on for 30 seconds and collect the water dispensed from the sprayhead. Repeat the test several times to confirm a consistent volume of dispensed water. If not consistent, check the valve, tubing and sprayhead for lime buildup.
	4. Dilution Valve	(A) If dilution is being used on the inconsistent brewing recipe, test the Dilution Valve. Refer to <i>Testing Individual Components</i> on page 36. Turn the valve on for 30 seconds and collect the water collected from the dilution opening. Repeat the test several times to confirm a consistent volume of dispensed water. If not consistent, check the valve, tubing and dilution opening for lime buildup. (B) Remove the dilution strainer/flow control and check for obstructions. Clear or replace.
	5. Lime buildup	Inspect for lime buildup that could block the tank, tank fittings, tubing, valves and sprayhead.

TROUBLESHOOTING (cont.)

Problem	Possible Cause	Troubleshooting Procedures
Consistently high or low beverage level in server.	1. Brew Volume adjustment	Adjust the brew volume as required to achieve the recommended volume for each brew cycle.
Dripping from sprayhead.	1. Brew Valve	Repair or replace leaky valve.
Water overflows filter.	1. Type of paper filters	BUNN paper filters should be used for proper extraction.
	2. No sprayhead	Check sprayhead
Beverage overflows server.	1. Beverage left in server from previous brew	The brew cycle should be started only with an empty server under the funnel.
	2. Brew Volume adjustment	Adjust the brew volume as required to achieve the recommended volume for each brew cycle.
Weak beverage.	1. Type of paper filters	BUNN paper filters should be used for proper extraction.
	2. Coffee	A sufficient quantity of fresh drip or regular grind should be used for proper extraction.
	3. Sprayhead	A clean sprayhead should be used to properly wet the bed of ground coffee in the funnel.
	4. Funnel Loading	The BUNN paper filter should be centered in the funnel and the bed of ground coffee leveled by gentle shaking.
	5. Water temperature	Empty the server, remove its cover, and place the server beneath the sprayhead. Place empty funnel over the server entrance, with ON/OFF switch in the "ON" position press the start switch and release it. Check the water temperature immediately below the sprayhead with a thermometer. The reading should not be less than 195°F(91°C).

TROUBLESHOOTING (cont.)

Problem

Weak beverage (cont.)

Possible Cause

6. Incorrect Recipe

Troubleshooting Procedures

Consider adjusting bypass percentage, preinfusion, or pulse brew. Contact Bunn-O-Matic for suggestions.

Brewer is making unusual noises.

1. Solenoid (Inlet)

The nut on back of the solenoid must be tight or it will vibrate during operation

2. Plumbing lines

Plumbing lines should not be resting on the counter top.

3. Water Supply

(A) The brewer must be connected to a cold water line.

(B) Water pressure to the brewer must not be higher than 90 psi (620 kPa). Install a regulator if necessary to lower the working pressure to approximately 50 psi (345 kPa).

4. Tank Heaters.

Remove and clean lime off tank heaters.

SCHEMATIC WIRING DIAGRAM SINGLE MULTI-BrewWise

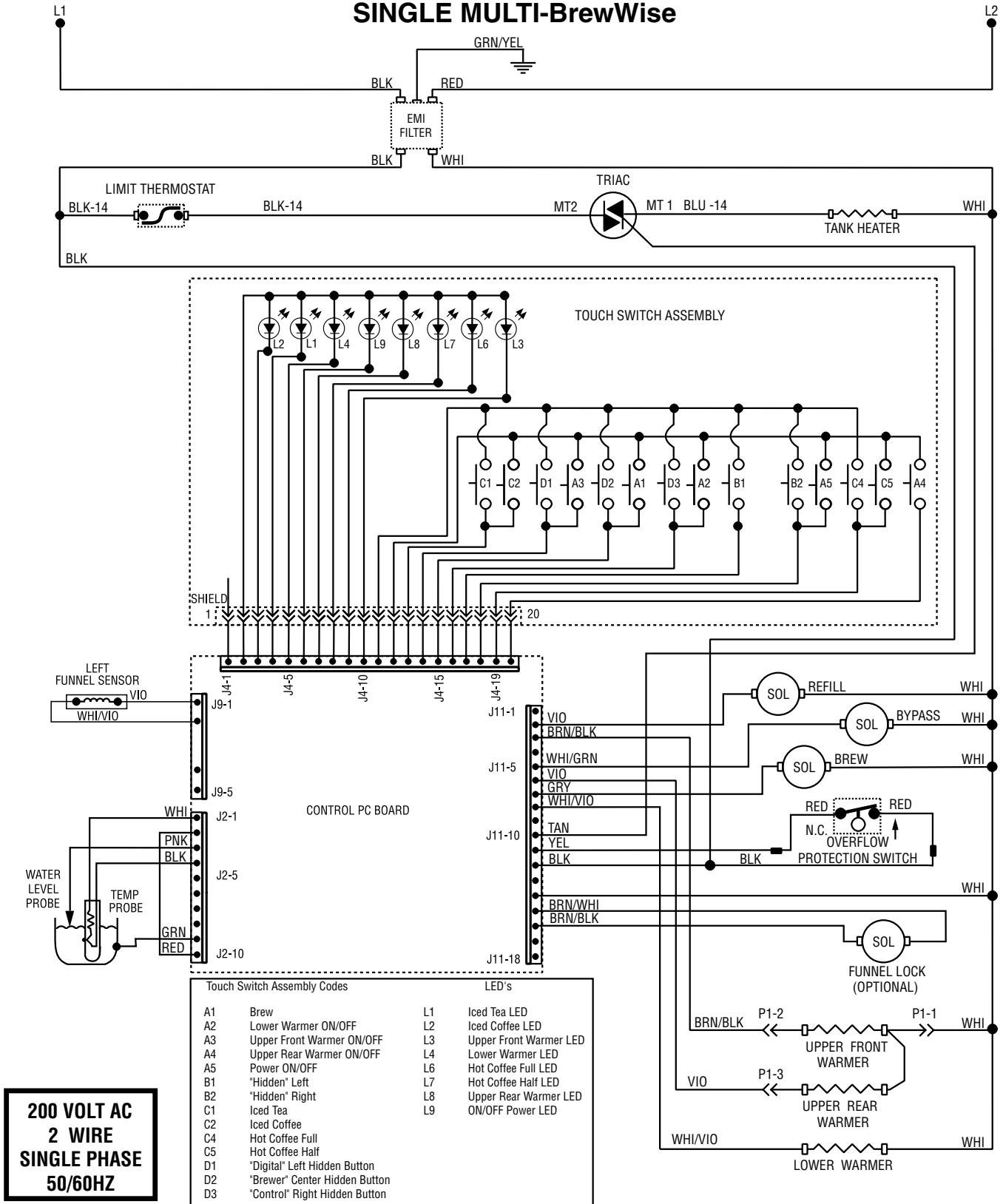

SCHEMATIC WIRING DIAGRAM SINGLE MULTI-BrewWise

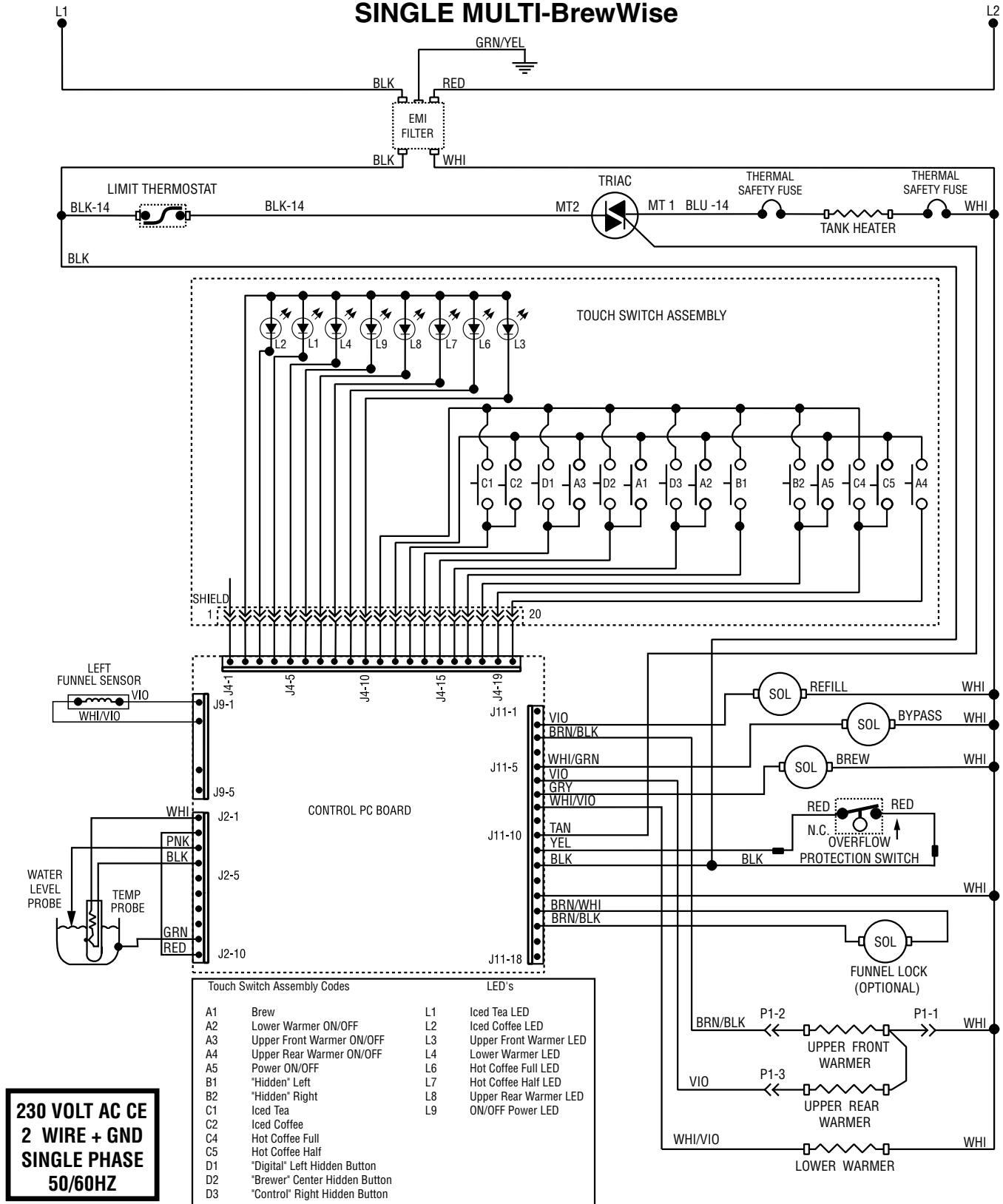

**230 VOLT AC CE
2 WIRE + GND
SINGLE PHASE
50/60HZ**

Touch Switch Assembly Codes		LED's	
A1	Brew	L1	Iced Tea LED
A2	Lower Warmer ON/OFF	L2	Iced Coffee LED
A3	Upper Front Warmer ON/OFF	L3	Upper Front Warmer LED
A4	Upper Rear Warmer ON/OFF	L4	Lower Warmer LED
A5	Power ON/OFF	L6	Hot Coffee Full LED
B1	"Hidden" Left	L7	Hot Coffee Half LED
B2	"Hidden" Right	L8	Upper Rear Warmer LED
C1	Iced Tea	L9	ON/OFF Power LED
C2	Iced Coffee		
C4	Hot Coffee Full		
C5	Hot Coffee Half		
D1	"Digital" Left Hidden Button		
D2	"Brewer" Center Hidden Button		
D3	"Control" Right Hidden Button		