

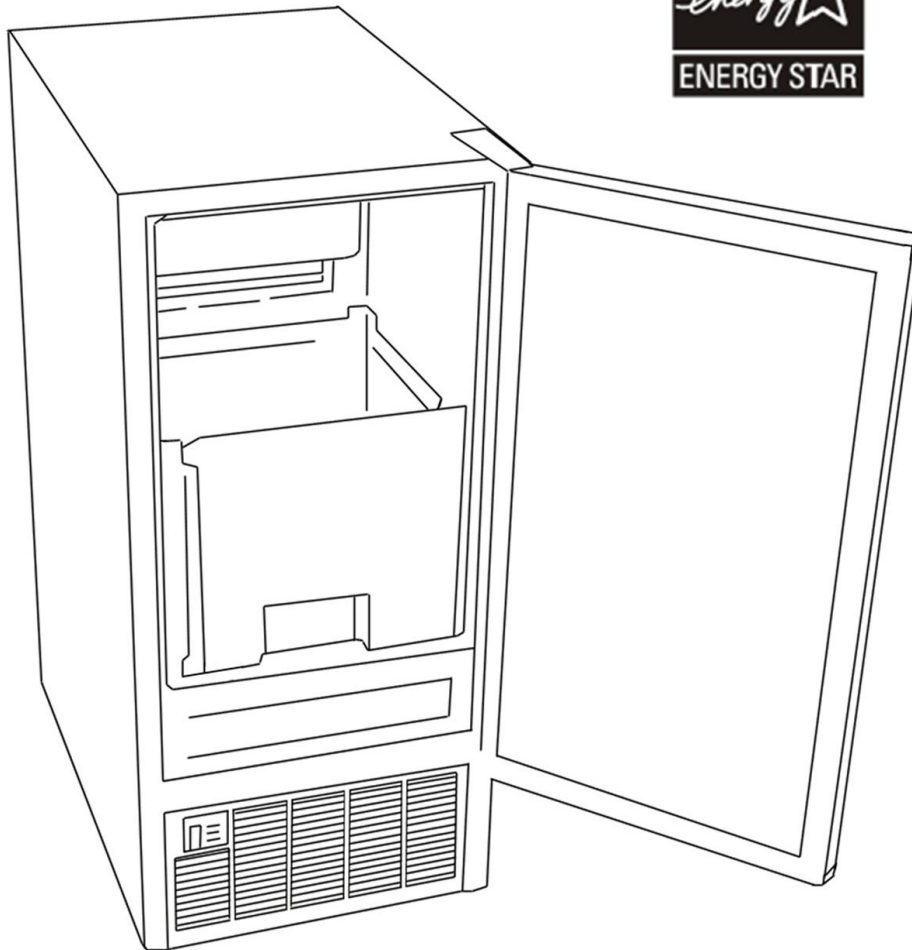

WHYNTER BUILT-IN ICE MAKER

MODEL # : UIM-501SS

Instruction Manual



Congratulations on your new WHYNTER product. To ensure proper operation, please read this Instruction Manual carefully before using this product. Keep this manual in a safe place for future reference.

TABLE OF CONTENTS

PARTS AND FEATURES	3
SAFETY PRECAUTIONS	4
INSTALLATION INSTRUCTIONS	5 - 6
ELECTRICAL REQUIREMENTS AND INSTALLATION	7 - 9
OPERATION INSTRUCTIONS	10 - 11
CARE AND MAINTENANCE	12 - 13
SETTINGS	14 - 15
TROUBLESHOOTING	16
WARRANTY INFORMATION	17

PARTS AND FEATURES

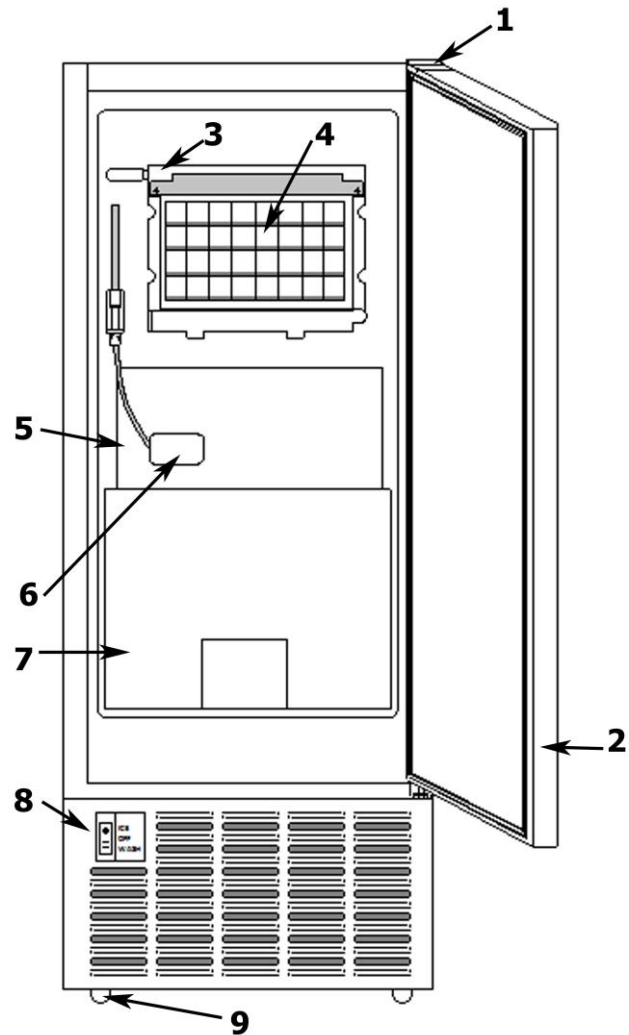

1. Door Hinge
2. Door
3. Distribution Tube
4. Ice Mold
5. Water Trough
6. Float
7. Ice Bin
8. Selector Switch
9. Leveling Foot
10. Control Panel
11. Power Plug
12. Water Inlet
13. Drain Outlet
14. Ice Scoop
15. Water Hose
16. Drain Hose

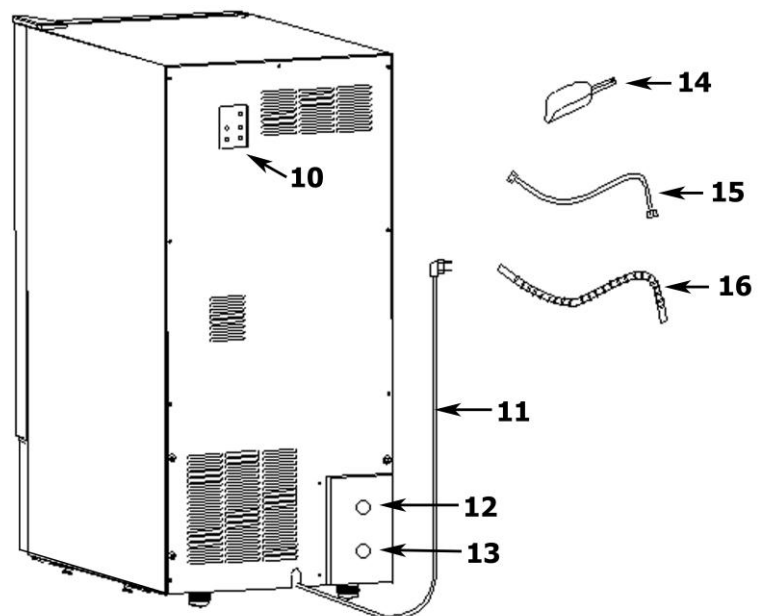

⚡WARNING⚡

TO REDUCE THE RISK OF FIRE, ELECTRICAL SHOCK, OR INJURY WHEN USING YOUR ICE MAKER, FOLLOW THESE BASIC PRECAUTIONS:

- READ ALL INSTRUCTIONS BEFORE USING THE ICE MAKER.
- **WARNING:** RISK OF DANGER TO SMALL CHILDREN AND SMALL ANIMALS. ENTRAPMENT AND SUFFOCATION DANGER IF NOT PROPERLY SECURED. DISPOSED OR ABANDONED APPLIANCES ARE STILL DANGEROUS
- **BEFORE YOU DISPOSE OF YOUR ICE MAKER:** REMOVE THE DOOR TO PREVENT CHILDREN FROM CLIMBING INTO THE UNIT.
- NEVER ALLOW CHILDREN TO OPERATE, PLAY WITH, OR CRAWL INTO THE APPLIANCE.
- NEVER CLEAN ICE MAKER PARTS WITH FLAMMABLE FLUIDS. THE FUMES CAN CREATE A FIRE HAZARD.
- DO NOT STORE OR USE GASOLINE OR ANY OTHER FLAMMABLE VAPORS AND LIQUIDS IN THE VICINITY OF THIS OR ANY OTHER APPLIANCE. THE FUMES CAN CREATE A FIRE HAZARD.

SAFETY PRECAUTIONS

Read all of the instructions before using this appliance. When using this appliance, always exercise basic safety precautions, including the following:

- Do not use if the power supply cord is damaged. If damaged, it must be replaced by qualified technician/electrician.
- Ensure the ice maker is unplugged before cleaning or if not in use.
- To clean the ice maker use only mild detergents or glass cleaning products. Never use harsh chemicals or solvents.
- Do not use this ice maker with an extension cord or power strip. Please ensure that the appliance is plugged directly into the electrical outlet.
- Close the ice maker door immediately after opening.
- Avoid placing the ice maker near external heat sources or direct sunlight.
- Make sure the ice maker is placed on a flat, level, and solid surface.
- Make sure that the surface on which the ice maker is placed is strong enough to hold the ice maker once it is fully loaded with ice.
- The ice maker is an electrical appliance. To avoid serious injury from electrical shock, do not operate the ice maker with wet hands, while standing on a wet surface, or while standing in water.
- Do not expose this appliance to rain or excessive moisture.
- Do not turn the ice maker upside down, on its side, or 45° or more off level.
- Never pull the power cord to disconnect the unit from an outlet. Grasp the plug directly and pull it from the outlet.
- This ice maker is designed for non-commercial use only.
- Do not plug this ice maker into the power socket before setup is completed.
- The cord should be secured behind the unit and should not be left exposed or dangling.
- Do not move this ice maker without securing the door.
- Performance may vary based on operational and ambient conditions.

INSTALLATION



Excessive Weight Hazard

Use two or more people to move and install icemaker. Failure to do so can result in back or other injury.

Remove packaging materials

IMPORTANT: Do not remove any permanent instruction labels or the data label on your icemaker.

Remove tape and glue from your icemaker before using

- To remove any remaining tape or glue, rub the area briskly with your thumb. Tape or glue residue can also be easily removed by rubbing a small amount of liquid dish soap over the adhesive with your fingers. Wipe with warm water and dry.
- Do not use sharp instruments, rubbing alcohol, flammable fluids, or abrasive cleaners to remove tape or glue. These products can damage the surface of your icemaker.

Cleaning before use

After you remove all of the packaging materials, clean the inside of your icemaker before using it. See the "Interior cleaning" in the Cleaning and Maintenance section.

Location Requirements

INSTALLATION CLEARANCES: (Unit shown in an enclosed setup)

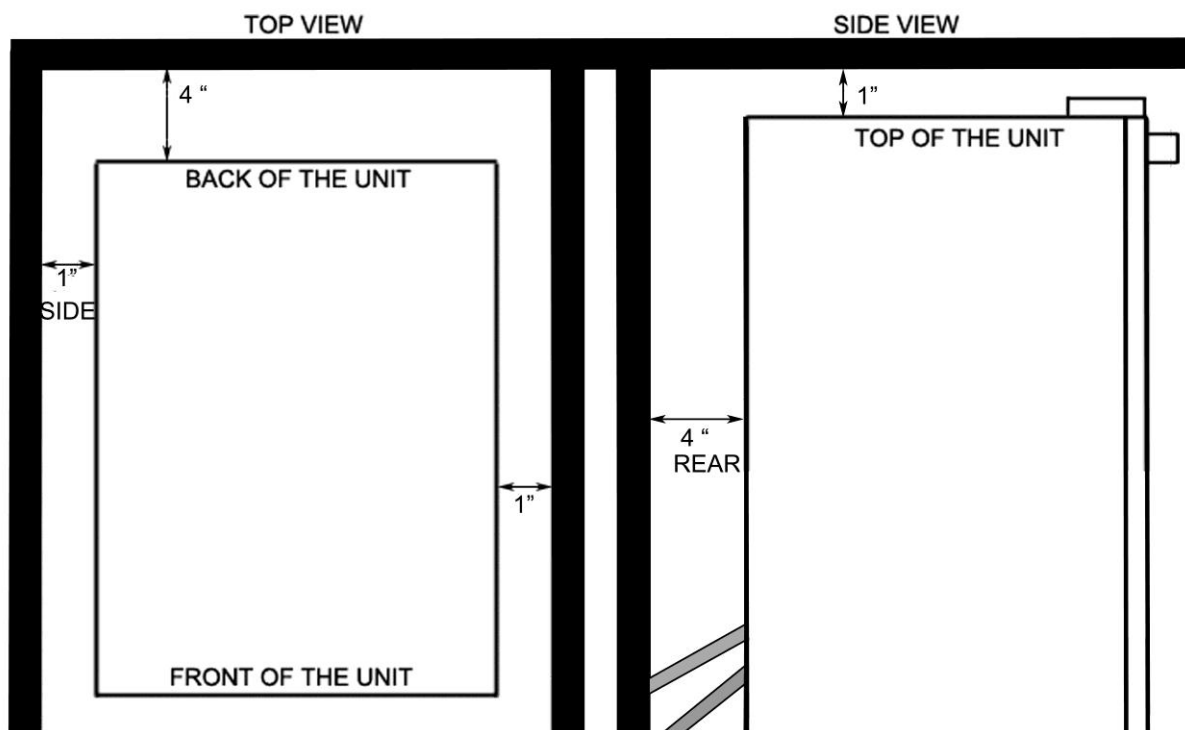

- **This icemaker should be installed by a licensed plumber only.**
- Before connecting the ice maker to the power source, let it stand upright for approximately 4 hours. This will reduce the possibility of a malfunction in the cooling system from handling during transportation.
- To ensure proper service access and ventilation, allow at least 4" clearance at rear, and 1" at top and sides. The installation should allow the icemaker to be pulled forward for servicing if necessary.

- When installing the ice maker under a counter, follow the recommended spacing dimensions shown. Place electrical and water supplies and drain fixtures in the recommended locations as shown.
- This unit **MUST** be installed in an area protected from the elements, e.g., wind, rain, water spray or drips. Do **NOT** use the ice maker in outdoor setting.
- The icemaker should not be located next to ovens, grills or other high heat resources.
- Too much humidity in the air will cause frost to form quickly on the evaporator requiring more frequent defrosting of the ice maker.
- The ice maker requires a continuous water supply with a minimum pressure of 15 psi and a static pressure not to exceed 80 psi.

⚠ WARNING ⚠

The ambient operational temperature should be between 50°F and 100°F. The input water temperature should be between 41°F and 90°F. Operation outside these temperatures may result in lowered production or other adverse effects.

- In general, it is always a good idea to filter the water. A water filter can remove taste and odors as well as particles. Where water is very hard, softened water may result in white, mushy cubes that stick together. Deionized water is not recommended.
- The ice maker must be installed with all electrical and water connections in accordance with state and local codes.
- The unit should be located on a hard and level surface that can support the unit when it is full. It is important for the ice maker to be level in order to work properly. If needed, you can adjust the height of the ice maker by turning the feet. See the “Leveling the Ice Maker” section.
- A standard electrical supply (115 VAC only, 60 Hz, 15 A), properly grounded in accordance with National Electrical Code and local codes and ordinances is required.
- **IMPORTANT:** Do not kink or pinch the power supply cord between the ice maker and wall or cabinet.

Extension Cord



Because of potential safety hazards under certain conditions, it is strongly recommended that you do not use an extension cord with this ice maker.

Technical Information

Electrical input:	115VAC ~ 60Hz
Power consumption:	155 Watts / 12.2kWh/100 lbs of ice
Ice-making/ Ice-harvest rated current:	3.0A/ 3.6A
Unit width x depth x height:	14.6" x 23.6" x 32.8"
Unit weight:	76 lbs
Ice storage capacity:	25 lbs
Ice-making capability:	50 lbs/day

NOTE: Technical data and performance information provided for reference only. Specifications are subject to change. Check the rating label on the ice maker for the most accurate information. The actual quantity of ice produced per day will vary with room and water conditions.

Electrical Requirements

 DANGER 

Electrical Shock Hazard
Plug into a grounded 3-prong outlet. Never remove the grounding prong from the plug. Never use an adapter. Never use an extension cord. Failure to follow these instructions can result in fire, electrical shock, or death.

Before you move your icemaker into its final location, it is important to make sure you have the proper electrical connection:

- A standard electrical supply (115V, 60Hz, 15A), properly grounded in accordance with the National Electrical Code and local codes and ordinances, is required.
- It is recommended that a separate circuit, serving only your icemaker, be provided. Use receptacles that cannot be turned off by a switch or pull chain.
- The fuse (or circuit breaker) size should be 15 amps.

Recommended grounding method

For your personal safety, this appliance must be grounded. It is equipped with a power supply cord having a 3-prong grounding plug. To minimize possible shock hazard, the cord must be plugged into a mating 3-pronged and grounding-type wall receptacle, grounded in accordance with the National Electrical Code and local codes and ordinances.

Leveling the Ice Maker

It is important for the icemaker to be leveled in order to work properly. It can be raised or lowered by turning the four feet on the bottom of the machine. We recommend using a carpenter's level to check the machine.

1. Place a carpenter's level on top of the product to see if the ice maker is level from front to back and side to side.
2. Adjust the height of the feet as follows:
 - Turn the leveling feet to the right to lower that side of the ice maker
 - Turn the leveling feet to the left to raise that side of the ice maker.

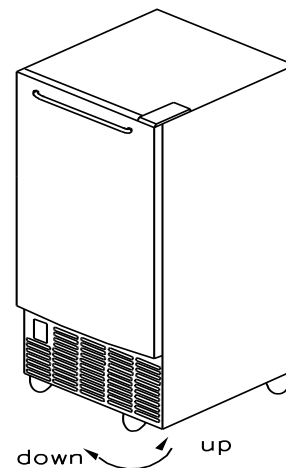

Reversing the Door Swing

This appliance has the capability of the door opening from either the left or right side. Should you desire to reverse the opening direction, please follow the following instructions.

Tools needed: Flathead screwdriver, Phillips screwdriver

IMPORTANT: Before you begin, unplug the ice maker or disconnect power.

To remove door from hinges:

1. Remove the top hinge cover.
2. Using a Phillips screwdriver, remove the screws, then remove top hinge mat and top hinge. Keep the parts together and set them aside.
3. Lift the door off the bottom hinge and set it aside.

To replace door on hinges:

1. Using a flathead screwdriver, remove the plug buttons from the screw holes opposite the door hinges, top and bottom. Set aside.
2. Remove the front louver. Set aside.
3. Remove the bottom hinge and place it on the opposite side at the bottom of the door.
4. Position the door on the bottom hinge.
5. Align the door on the bottom hinge and replace the top hinge and top hinge mat.
6. Replace top hinge cover.
7. Push the plug buttons into the original screw holes

See Figure below:

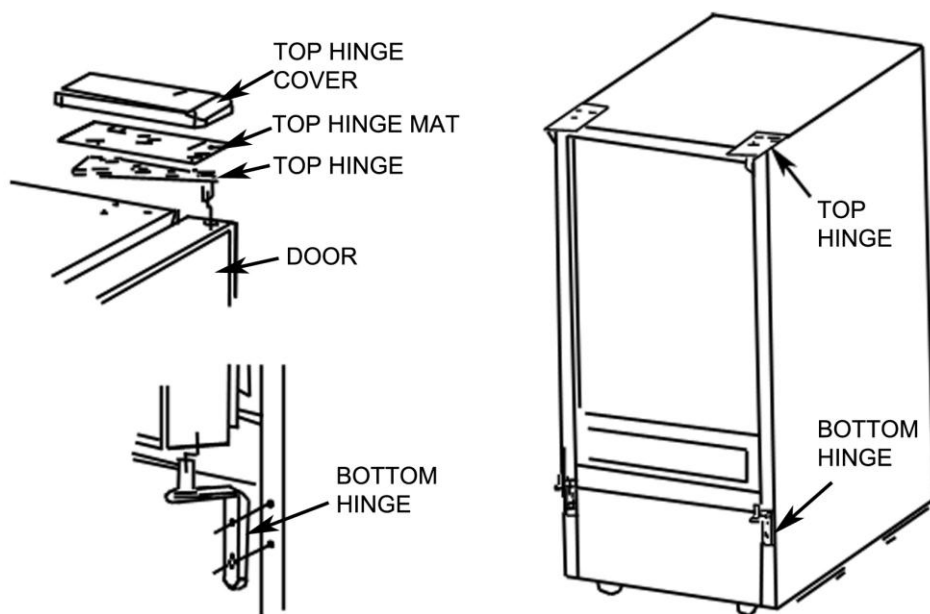

Water Supply Connections

The water supply should be ready at the point of installation. The water supply pressure should be a minimum of 15 psi with a static pressure not more than 80 psi. (A wall outlet directly behind the ice maker will make installation easier.)

IMPORTANT:

1. All installations must be in accordance with local plumbing code requirements.
2. Make certain that the pipes are not pinched or kinked or damaged during installation.
3. Check for leaks after connection.

Tools required: ½ in. open-end wrench, Phillips screwdriver

Connecting the water line:

1. Turn off main water supply. Turn on nearest faucet long enough to clear line of water.
2. Find a ½ in. to ¾ in. vertical cold water pipe near the installation location. The distance should be less than 9 feet. The water supply hose provided with the ice maker is about 9 feet long.
3. A shut-off valve must be installed to the main water supply. If the water pipe has a plain piece of copper tubing, attach a ¼" O.D. compression union to the tubing and remove the nut.

4. Connect nuts of the water supply hose to tap and water inlet valve. Tighten firmly by hand, then one-half turn with wrench.
5. Turn on main water supply and tap. Check for water supply connection leaks. Tighten every connection (including connections at the water inlet).

IMPORTANT: When you connect the water supply hose, pay attention to the indications of "Water inlet" on the machine.

Draining

NOTE: There is a drain line on the ice maker. Please drain water to your drain through the drain line provided with ice maker.

1. Locate the floor drain near the ice maker. The distance should be less than 5 feet since the length of the long drain hose provided is about 5 feet.
2. Find the drain hose on the back of ice maker, and then insert the other side of the hose into the drain line.
3. All horizontal runs of drain lines must have a fall of 1/4" per foot. An air gap will likely be required between the ice maker drain hose and the drain/waste receptacle. A stand pipe with a trap below it would be acceptable for the drain/waste receptacle. A floor drain is also acceptable.
4. Pour 1 gallon of water into the ice storage bin to check for proper drainage.

Note: a condensate pump can allow for installation further from your drain. Consult your plumber for advice.

Installation Types

This ice maker is designed for free-standing, recessed, or built-in installation. In every setting, there must be adequate ventilation and access for service. Never install or operate the unit in an enclosed area, such as a closed cabinet.

Free-standing installation:

A free-standing installation will allow you to install the icemaker in any place you desire provided you have access to a water supply and a drain. You must follow the stated instructions for:

- a - Electrical requirements
- b - Water supply and drain
- c - Leveling the icemaker

Recessed installation:

A recessed installation will allow you to install the ice maker under a counter or in a kitchen cabinet provided the required clearance space around the ice maker is respected. This installation has the same requirements as a built-in installation.

Built-in installation:

If this method of installation is chosen, it will still be necessary to allow adequate ventilation space around the unit (make sure there is at least some ventilation room for the back of the unit). The following additional items must be observed.

1. Place ice maker in front of installation location. Remove the feet and place the unit flat on the floor or on a platform depending on your installation requirements.
2. The water supply pipe must be plumbed before connecting to the ice maker. Install the drain line into your drain.
3. Turn on main water supply and tap. Check for water supply connection leaks. Tighten any connections (including connections at the tie-in).
4. If electrical outlet for the ice maker is behind the cabinet, plug in the ice maker.
5. Push the ice maker into position.
6. Seal all around the cabinet to the floor with an approved caulking compound.

OPERATION

Final Check List before Operation

1. Have all packing materials and tape been removed from the interior and exterior of the ice maker?
2. Did you clean the ice storage bin? We recommend cleaning the interior surface with lukewarm water using a soft cloth.
3. Have the installation instructions been followed, including connecting the machine to electricity, water supply and water drainage?
4. Is the ice maker level?
5. Is the ice maker in an indoor site where the ambient temperature is between 50° F and 100°F and the input water temperature between 41° F and 90° F all year round?
6. Has the water supply pressure been checked to ensure a minimum of 15 psi with a static pressure not to exceed 80 psi?
7. Is there a clearance of at least 4" at the rear, 1" at the top and sides for proper air circulation?
8. Has the power supply voltage been checked or tested against the rating label at the back of the unit? And has proper grounding been installed for the ice maker?
9. Is the ice maker plugged in?
10. Have the main water supply and the tap turned on?
11. Have you checked for leaks at all water supply connections and at the drain?

Operating Method

1. Turn on the water tap, let the water to fill. Then switch the ICE/OFF/WASH switch on the front panel to the ICE position. The ice maker will start working automatically

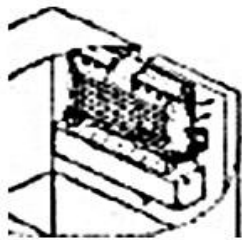

Ice making stage

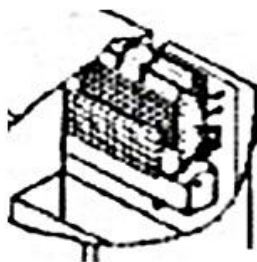

Ice harvest stage

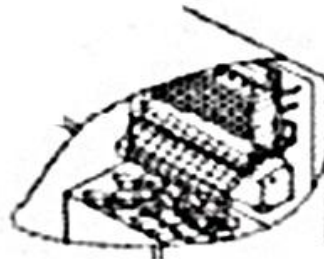

Ice full stage

2. After three minutes, the machine will automatically go to the ice making stage, and the sound of flowing water will be heard.
3. When the batch of ice is fully formed, ice will automatically be harvested to the ice storage bin.
4. When the ice storage bin is full, the sheet of ice cubes will not fall completely and will hold the ice-full probe open. The machine will stop making ice automatically.
5. The unit will start making ice again after the ice cubes are removed or melted. At that time, the ice-full probe swings back to operating position.

IMPORTANT:

- *Although the unit has been tested and cleaned at the factory, due to long-term transit and storage, throw away all ice cubes made during the first 3 hours of operation.*
- *Never turn the water supply tap off when the ice maker is operating.*
- *Never touch the evaporator when the ice maker is running.*
- *Except to take ice from the unit, keep the door closed to reduce melting and ensure proper ice formation.*

How the machine makes ice

There are two distinct cycles: Freeze and Harvest.

Freezing: During the freezing cycle, the compressor pumps refrigerant, the fan motor blows air and the water pump circulates water. When the batch of ice has been fully formed, the ice maker stops the freezing cycle and begins the harvest cycle.

Harvest: During the harvest cycle, the compressor is still operates, but the water pump stops. The hot gas valve opens, diverting hot refrigerant gas into the evaporator. The gas warms the evaporator, causing the cubes to fall, as a unit, off the evaporator and into the storage bin. The freezing cycle will restart when all the cubes have been harvested. A complete cycle can take 15 to 40 minutes, depending on water temperature and ambient conditions.

How the machine uses the water

The ice maker begins with a fixed charge of water that is contained in the water trough. As the water flows to the freezing evaporator surface, the portion of water that does not contain mineral impurities will freeze and stick to the ice cube mold. The water containing impurities falls back into the trough. During the ice-making process, fresh water enters the water trough continuously as the water from the trough freezes continuously on the evaporator.

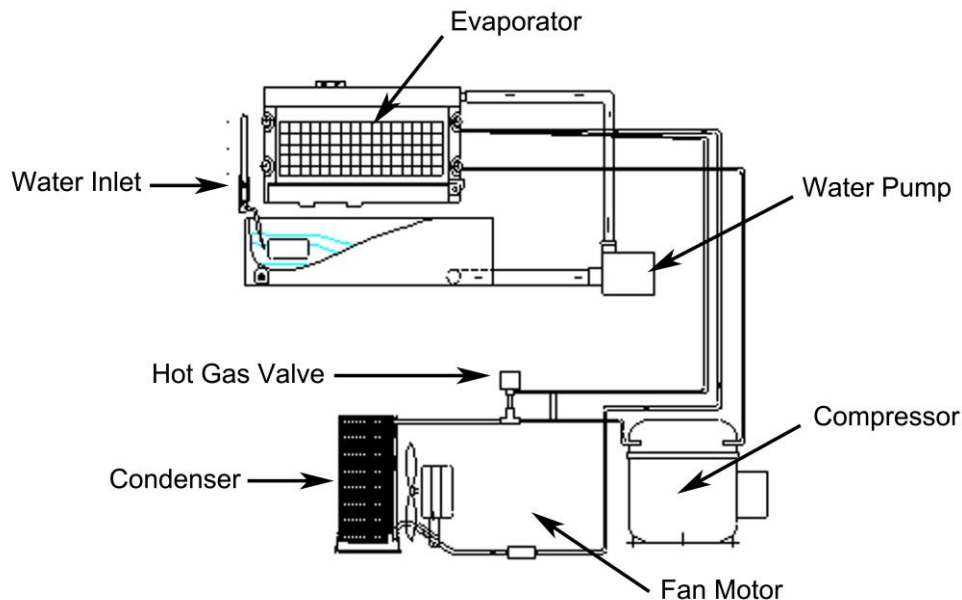

Normal Sounds

Your new ice maker may make sounds that are not familiar to you. Hard surfaces like the floor, walls can make the sounds seem louder than they actually are. The following describes the kinds of sounds that might be new to you and what may be making them.

- Rattling noises may come from the flow of the refrigerant or the water line, items stored on top of the icemaker can also make noises.
- The high efficiency compressor may make a pulsating or high-pitched sound.
- Water running from the evaporator to the water bin may make a splashing sound.
- As each cycle ends, you may hear a gurgling sound due to the refrigerant flowing in your ice maker.
- You may hear air being forced over the condenser by the condenser fan.
- During the harvest cycle, you may hear the sound of ice cubes falling into the ice storage bin

CARE AND MAINTENANCE

! WARNING !

Before proceeding with cleaning and maintenance operations, make sure the power line of the unit is disconnected and the water line is shut off. (EXCEPTION: Cleaning of ice-making system)

Preparing the Ice Maker for Long Storage

If the ice maker will not be used for a long time, or is to be moved to another place, it will be necessary to drain the system of water.

1. Shut off the water supply at the main water source.
2. Disconnect the water supply line from the water inlet.
3. Shut off the electric supply at the main electrical power source.
4. Take out the ice storage bin to remove ice and water.
5. Pull down the drainage tube of the water trough to drain off all water.

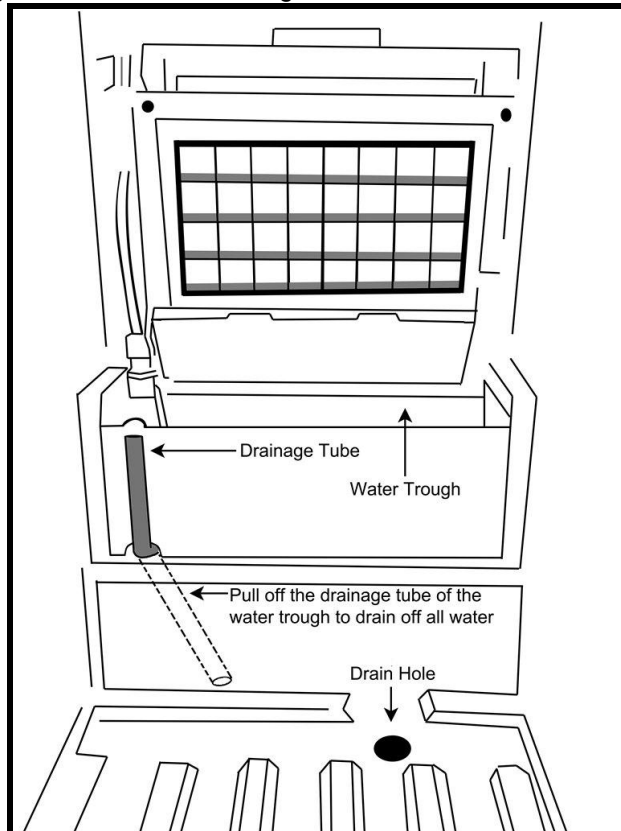

6. Leave the door open to allow for circulation and to prevent mold and mildew.
7. Leave the water supply line and power cord disconnected until ready to reuse.

IMPORTANT:

- Do not touch the power plug when your hands are wet.
- Never unplug the unit by pulling on the plug.

CAUTION

The ice maker must be thoroughly cleaned if it has been left unused for a long time.

Periodic cleaning and proper maintenance will ensure efficiency, performance and life expectancy of the ice maker. The maintenance intervals listed are based on normal conditions. You may want to shorten the intervals if you have pets, or there are other special considerations.

IMPORTANT:

Never keep anything in the ice storage bin that is not ice: objects like wine or beer bottles are not only unsanitary, but the labels may slip off and clog up the drain.

There are 5 things to keep clean:

- The exterior
- The interior
- The condenser
- Water distribution tube
- The ice-making system

Exterior Cleaning

The door and cabinet may be cleaned with a mild detergent and warm water solution such as 1 oz. of dishwashing liquid mixed with 2 gallons of warm water. Do not use solvent based or abrasive cleaners.

Interior Cleaning

The ice storage bin should be sanitized occasionally. Clean the water trough before the ice maker is used for the first time and reused after stopping for an extended period of time. It is usually convenient to sanitize the trough after the ice making system has been cleaned and the ice storage bin is empty. Do not use solvent based or abrasive cleaners.

1. Disconnect power to the unit.
2. Open the door and take out the removable storage bin. With a clean cloth, wipe down the interior of the unit with a sanitizing solution made of 2 tablespoons of baking soda and a quart of warm or hot water.
3. Rinse thoroughly with clean water.
4. Put the cleaned and empty ice storage bin back inside the unit.
5. Reconnect power to the unit.

The ice scoop should be washed regularly.

Condenser Cleaning

A dirty or clogged condenser prevents proper airflow, reduces ice making capacity and may lead to component failure. Have the condenser cleaned at least once every six months.

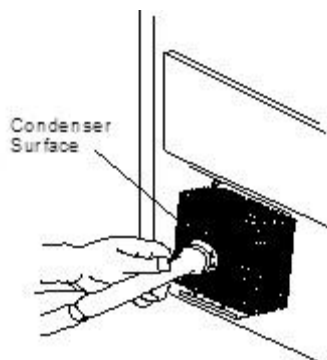

1. Unplug the ice maker or disconnect power.
2. Remove the 2 screws at the bottom of the front cover and gently pull it off.
3. Remove dirt and lint from the condenser and the unit compartment with a brush attachment on a vacuum cleaner.
4. Reassemble the front cover.
5. Plug in the icemaker or reconnect power.

Water Distribution Tube cleaning

When you find that the ice cubes are incompletely formed or the output of ice cubes is low, the water

distribution tube may be blocked.

1. Shut off the water supply.
2. Disconnect the water hose from the distribution tube.
3. Gently take out the distribution tube.
4. With a brush, clean the tube with a dilute solution of warm water and baking soda or white vinegar. After removing the dirt and lint from the surface, rinse the tube with clean water.
5. Replace the distribution tube.
6. Reconnect the water supply.

Ice-making system cleaning

Minerals that are removed from water during the freezing cycle will eventually form a hard scaly deposit in the water system. Cleaning the system regularly helps remove the mineral scale buildup. How often you need to clean the system depends upon how hard your water is or how effective your filtration may be. With hard water of 15 to 20 grains/gal. (4 to 5 grains/liter), you may need to clean the system as often as every 6 months.

1. Make sure that all the ice is off the evaporator. If ice is being made, wait for cycle completion, then turn the machine "OFF" at the ICE/OFF/WASH selector switch.
2. Remove all ice from the storage bin.
3. Keep the ice maker connected to the water supply, Pour 8 oz. (230g) of Nickel-Safe Ice Maker Cleaner Solution into the water trough. After about 5 minutes, initiate the wash cycle at the ICE/OFF/WASH selector switch by the switch in the "WASH" position. The machine will run the Automatic Clean Mode.
4. Allow 30 minutes for proper cleaning. After cleaning, turn the machine "OFF", then drain off the cleaning water to a container by the drain pipe in the left of the water trough.
5. Repeat steps 3 and 4 (without Ice Maker Cleaning Solution) to rinse the ice making system 3 times.
 - *Note: The use of the Ice Maker Cleaner Solution in the water bin during the rinse is not needed.*



The ice machine cleaner contains acids.

DO NOT use or mix with any other solvent-based cleaner products.

Use rubber gloves to protect your hands. Carefully read the material safety instructions on the container of the ice machine cleaner.

Discard the first batch of ice produced after cleaning.

6. Prepare a sanitizing solution made of 2 tablespoons of baking soda and a quart of warm or hot water. Wipe the entire bin inside and out, covering every wall surface.
7. Repeat step 6 to rinse the ice making system.
8. Switch to the "ICE" position. The machine will return to the regular ice making mode. Discard the first batch of ice.

Control Box (rear of unit)

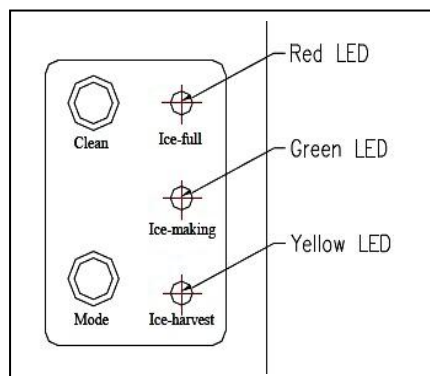

Descriptions of LEDs and buttons:

1. **Red LED:** Ice Full indicator light.
When this LED is lit, the ice storage bin is full of ice or there is something between the two arms of the ice-full sensor in the ice storage bin. The unit will stop working. When ice cubes are taken out of the ice storage bin, clearing the sensor, the red LED will keep flashing for 3 minutes. Then the unit will restart and return to the ice making mode.
2. **Green LED:** Ice making indicator light.
When this LED is lit, the unit is working in the Ice Making mode controlled by a temperature probe on the evaporator. When the green LED is flashing, the unit is working in the Ice Making mode controlled by a fixed timer.
3. **Yellow LED:** Ice Harvest indicator light.
When this LED is lit, the unit is working in the Ice Harvest mode controlled by a temperature probe on the evaporator. When the yellow LED is flashing, the unit is working in the Ice Harvest mode controlled by a fixed timer.
4. **Clean button:**
When this button is pressed, the unit enters the Cleaning mode. The green and yellow LEDs flash together. To stop the Cleaning mode, just press the button again.
5. **Mode button:** Mainly for service.
When this button is pressed, unit can change from Ice Making mode to Ice Harvest mode or from Ice Harvest mode to Ice Making mode.
6. **Ice Size Adjustment Guide:**
 - 1.) Press and hold the “**Clean**” button and the “**Mode**” button together for at least 3 seconds. The unit will enter the Ice Size Adjustment mode. The “**ICE Making**” LED (green) will be blinking continuously during the ice size adjustment.
 - 2.) While in the Ice Size Adjustment mode, press the “**Clean**” button or the “**Mode**” button for the desired ice size.

Smaller ice setting:

By pressing the “Clean” button, you can decrease the size of the ice cubes. The “ICE FULL” LED (red) will flash as you lower the ice size and will finally be blinking at the setting of smallest ice size.

Larger ice setting:

By pressing the “Mode” button, you can increase the size of the ice cubes. The “ICE HARVEST” LED (yellow) will flash as the larger size is set and will blink when the setting of largest ice size has been reached. After 10 seconds without any operation, the unit will automatically memorize the current state and return to the previous mode.

NOTE: If during the ice size adjustment, the “ICE FULL”, “ICE MAKING” and “ICE HARVEST” LEDs blink all at once, this indicates that the unit is in the default factory setting of the ice size adjustment.

TROUBLESHOOTING

Many common ice maker problems are easily resolved. Try the troubleshooting suggestions below to see if the problems can be resolved before having to contact the service department.

Problem	Possible Cause	Probable Correction
The machine won't operate.	<ul style="list-style-type: none"> • The icemaker is unplugged. • The fuse is blown. • The icemaker power switch is OFF. • The ice storage bin is full of ice. 	<ul style="list-style-type: none"> • Plug the ice maker in. • Replace fuse. • Turn the ice maker power switch to ICE (ON) • Take away some ice cubes; make the ice full probe is free of ice.
The water doesn't feed in after the ice maker starts.	<ul style="list-style-type: none"> • The water supply tap is turn off. • The water supply pipe is not proper connected. 	<ul style="list-style-type: none"> • Turn on the water supply tap. • Reconnect the water supply pipe.
Machine makes ice, but bin does not fill up with ice	<ul style="list-style-type: none"> • The condenser may be dirty. • The air flow to the ice maker may be obstructed. • The ambient temperature and water temperature are high, or it is near with some heat source. 	<ul style="list-style-type: none"> • Clean the condenser.
		<ul style="list-style-type: none"> • Check the installation. • Run the unit for longer period of time.
Water is leaking out the unit.	<ul style="list-style-type: none"> • A few water droplets are on the door. • The water supply connection is leaking. 	<ul style="list-style-type: none"> • Under some conditions, humidity may condense on the door. Consider moving the unit or just be more careful when you open the door. • Tighten fitting. See "Connecting the water line".
Cubes are partially formed--are white at the bottom.	<ul style="list-style-type: none"> • Not enough water in the water bin. 	<ul style="list-style-type: none"> • Check if the water supply pressure is below 15 psi. • Check water supply--filter may be restricted. • Check for a water leak at the water trough.
Noise during operation	<ul style="list-style-type: none"> • The feet are not leveled and locked. 	<ul style="list-style-type: none"> • Level and lock the feet. See Leveling the Ice Maker.
	<ul style="list-style-type: none"> • Certain sounds are normal. 	<ul style="list-style-type: none"> • See "Normal Sounds."
The icemaker stops suddenly while making ice.	<ul style="list-style-type: none"> • The electricity is off. 	<ul style="list-style-type: none"> • Reconnect the power supply line.
	<ul style="list-style-type: none"> • The room temperature is out of the stated range. 	<ul style="list-style-type: none"> • Cut off the electricity and let the ice maker stop working until the temperature returns within the stated range.
The body of the ice maker is electrified	<ul style="list-style-type: none"> • The ground line isn't in the socket. 	<ul style="list-style-type: none"> • Use the correct plug and outlet.
Scale builds up quickly inside the machine.	<ul style="list-style-type: none"> • The calcium level in the water is too high. 	<ul style="list-style-type: none"> • Use a water softening apparatus installed in front of the water inlet valve.

ONE YEAR LIMITED WARRANTY

This WHYNTER Ice maker is warranted, to the original owner within the 48 continental states, for one year from the date of purchase against defects in material and workmanship under normal use and service. Should your ice maker prove defective within one year from the date of purchase, return the defective part or unit, freight prepaid (within two months of purchase; after two months to one year, customer will be responsible for freight cost to Whynter's service department), along with an explanation of the claim to Whynter LLC. Please package the ice maker carefully in its original packaging material to avoid damage in transit. Please retain the original box and packaging material. Under this warranty, Whynter will repair or replace any parts found defective. This warranty is not transferable. After the expiration of the warranty, the cost of labor and parts will be the responsibility of the original owner of the unit.

THIS WARRANTY DOES NOT COVER:

- Acts of God, such as fire, flood, hurricanes, earthquakes and tornadoes.
- Damage, accidental or otherwise, to the ice maker while in the possession of a consumer not caused by a defect in material or workmanship;
- Damage caused by consumer misuse, tampering, or failure to follow the care and special handling provisions in the instructions.
- Damage to the finish of the case, or other appearance parts caused by wear.
- Damage caused by repairs or alterations to the product by anyone other than authorized by the manufacturer.
- Freight and Insurance cost for the warranty service.

DISCLAIMER OF IMPLIED WARRANTIES; LIMITATION OF REMEDIES

CUSTOMER'S SOLE AND EXCLUSIVE REMEDY UNDER THIS LIMITED WARRANTY SHALL BE PRODUCT REPAIR OR REPLACEMENT AS PROVIDED HEREIN. CLAIMS BASED ON IMPLIED WARRANTIES, INCLUDING WARRANTIES OF MERCHANTABILITY OR FITNESS FOR A PARTICULAR PURPOSE, ARE LIMITED TO ONE YEAR OR THE SHORTEST PERIOD ALLOWED BY LAW, BUT NOT LESS THAN ONE YEAR. WHYNTER SHALL NOT BE LIABLE FOR CONSEQUENTIAL OR INCIDENTAL DAMAGES SUCH AS PROPERTY DAMAGE AND INCIDENTAL EXPENSES RESULTING FROM ANY BREACH OF THIS WRITTEN LIMITED WARRANTY OR ANY IMPLIED WARRANTY. SOME STATES AND PROVINCES DO NOT ALLOW THE EXCLUSION OR LIMITATION OF INCIDENTAL OR CONSEQUENTIAL DAMAGES, OR LIMITATIONS ON THE DURATION OF IMPLIED WARRANTIES, SO THESE LIMITATIONS OR EXCLUSIONS MAY NOT APPLY TO YOU. THIS WRITTEN WARRANTY GIVES YOU SPECIFIC LEGAL RIGHTS. YOU MAY ALSO HAVE OTHER RIGHTS THAT VARY FROM STATE TO STATE.

To obtain service or information, contact
Whynter via email at service@whynter.com or call
866-WHYNTER.

Product contents and specifications may change without notice.
Copyright © 2013 Whynter LLC
www.Whynter.com