



4 Channel H.264 DVR



P-6T4, SW242-6T4

Swann Security

www.swannsecurity.com

EN110608

FCC WARNING STATEMENT

This device complies with Part 15 of FCC Rules.

Operation is subject to the following two conditions:

- (1) This device may not cause harmful interference, and
- (2) This device must accept any interference received, including interference that may cause undesired operation

Important Notice

All jurisdictions have specific laws and regulations regarding the use of cameras. Before using any camera for any purpose, it is the buyer's responsibility to be aware of all applicable laws and regulations that prohibit or limit the use of cameras and to comply with the applicable laws and regulations. The legality of watching people other than you changes from country to country and even state to state. Contact your local government's privacy information body or your local Police for more information on what if any restrictions you may face.

WARNING: Important notice about correct usage of the power adapter

The correct orientation for the enclosed power adapter is in a vertical or floor mount position.

CONTENTS

CHAPTER 1 Introduction	1
1.1 DVR Introduction	1
1.2 Main Features and Specification.....	1
CHAPTER 2 Panel Function	3
2.1 Check the Accessories	3
2.2 Front Panel & Interface Terminals.....	3
2.3 Back Panel & Interface Terminals	4
2.4 Remote Controller Introduction	5
2.4.1 Use Remote Controller.....	5
2.4.2 Facie of Remote Controller	6
CHAPTER 3 Basic Operation Guide	10
3.1 How to Start DVR.....	10
3.2 Main Menu Setting.....	10
3.2.1 Basic Configuration	12
3.2.2 Live Configuration	13
3.2.3 Record Configuration	15
3.2.4 Alarm Configuration.....	17
3.2.5 PTZ Configuration	22
3.2.6 User Configuration	23
3.2.7 Network Configuration.....	24
3.2.8 Manager Tools.....	29
3.3 Shortcut Menu	33
3.3.1 PTZ	33
3.3.2 Search.....	34
3.3.3 Information	39
3.3.4 Other.....	39
CHAPTER 4 Remote Surveillance	41
4.1 Accessing DVR.....	41

4.1.1 Accessing DVR in LAN.....	41
4.1.2 Accessing DVR in WAN	42
4.2 Main Interface	44
4.2.1 Login	44
4.2.2 Snap Picture	45
4.2.3 Parameter Settings	45
4.2.4 Record	45
4.2.5 Camera Audio	45
4.2.6 DVR Status Panel	45
4.3 Remote Playback and Search	46
4.3.1 Remote Playback.....	46
4.3.2 Other Functions.....	47
4.4 Remote DVR Configuration	50
4.4.1 Basic Configuration.....	52
4.4.2 Live Configuration	53
4.4.3 Record Configuration	54
4.4.4 Alarm Configuration.....	56
4.4.5 Network Configuration.....	56
4.4.6 User Configuration	56
4.4.7 Manage Tools.....	56
4.5 Remote PTZ	57
CHAPTER 5 Operation with Mouse	61
5.1 Switch the Display of Channel.....	61
5.2 Enter the Menu List.....	61
5.2.1 Search.....	61
5.2.2 Configuration.....	61
5.2.3 PTZ Control.....	62
5.3 Fast Reverse and Fast Forward	63
CHAPTER 6 Frequently Asked Questions	64
Appendix A Main Standard & Parameter	65
Appendix B Record Capability	67
Appendix C Abbreviation.....	677

CHAPTER 1 Introduction

1.1 DVR Introduction

This DVR adopts the unique solution of Dual Stream technology, with a main processor that can process the signal of DVR recording and signal of internet transmission simultaneously, utilizing standard H.264 algorithm, the latest advanced video compression format. The solution allows DVR to have powerful internet function of remote controlling DVR completely, good internet speed, and high quality picture recording with very low bit rate, saving HDD space with long hour recordings.

1.2 Main Features and Specification

LIVE SURVEILLANCE

- Support channel security by hiding live display
- Display the local record state and basic information
- Two level password control: administrator and common user

COMPRESSION FORMAT

Standard H.264.

RECORD MEDIA

The DVR supports to install one SATA HDD to record only.

BACKUP

- Support to backup via USB to USB flash memory
- Support to backup remotely by network client

RECORD & PLAYBACK

- Record modes: Manual operation, Sensor detection, Schedule Record and Motion detection
- Support HDD recycle
- Support single channel playback
- Support deleting and locking the record
- Support remote playback in Network Client through LAN or internet
- Two record search mode: time search and event search

ALARM

4 alarm inputs and 1 alarm output.

PTZ CONTROL

- Support various PTZ protocols
- Support various PTZ preset
- Support remote PTZ control

COMMUNICATION PORT

RS 485 communication port.

NETWORK

- Support TCP/IP protocol
- Support remote DVR configuration
- Support static IP, dynamic IP (DHCP) and PPPoE
- On-time live surveillance, remote playback, remote backup
- Remote PTZ control and Preset
- Support IE browser for Network Client software

CHAPTER 2 Panel Function

Please make sure DVR is powered off before you connect the DVR with other equipment.

Do not hot plug in!

2.1 Check the Accessories

When you receive the machine, please check accessories and make sure you have all the parts.

Normally, accessories include: a mouse, a Remote Controller, a power cable, a CD-ROM with 'Network Client' software and some screws for installing HDD.

You could use screwdriver and some screws to fix the HDD into DVR. The DVR can connect one HDD only.

2.2 Front Panel & Interface Terminals

The buttons on the Front Panel please refer to the entity. There might be slightly difference from below figures. You could contrast below figure to the entity for realizing the function of every button.

The Front Panel and interface terminal is shown as Fig2.1 Front Panel.

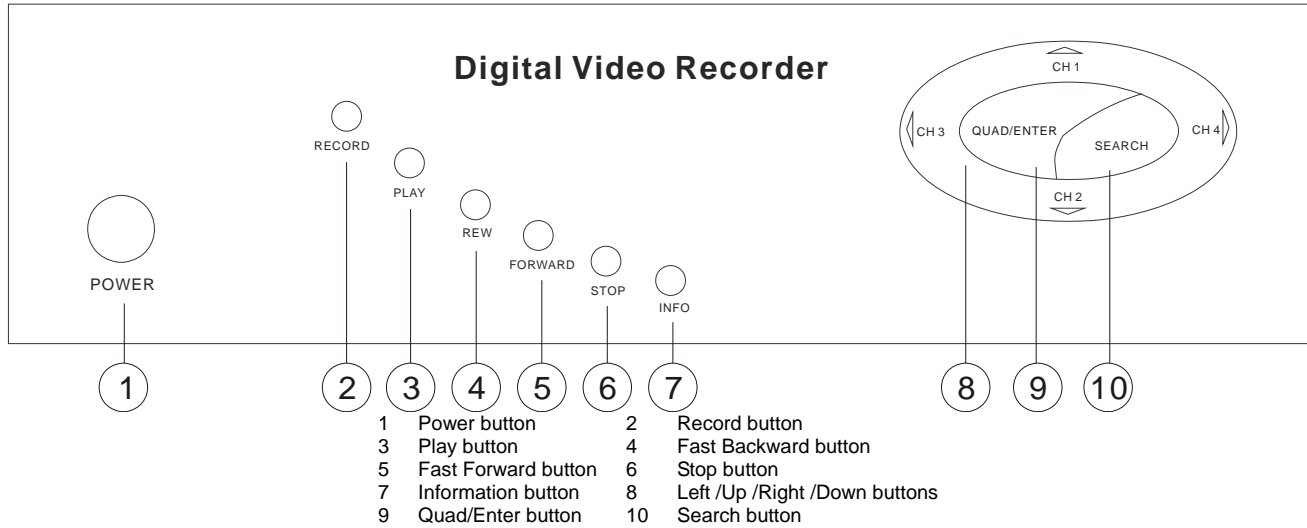
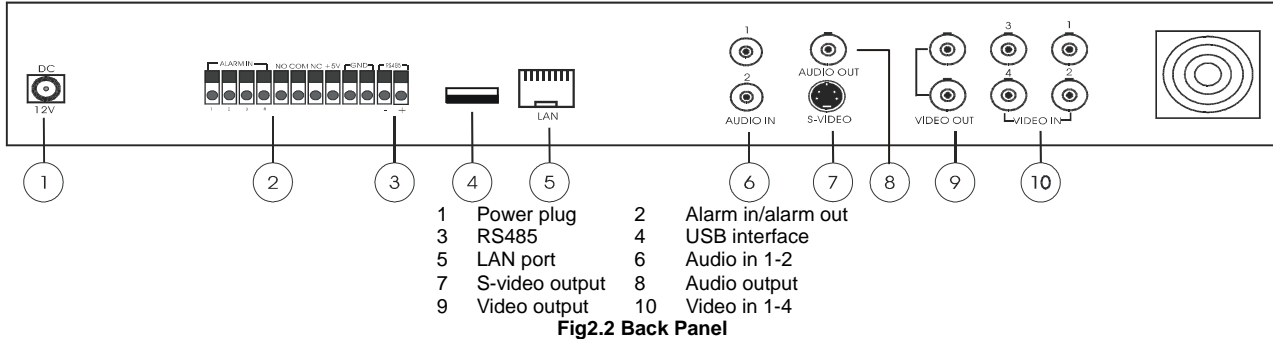

Fig2.1 Front Panel

2.3 Back Panel & Interface Terminals

The interfaces on the Back Panel please refer to the entity. There might be slightly difference from below figure. You could contrast below figure and the entity for realizing the function of every interface.

The Back Panel and interface terminal is shown as Fig2.2 Back Panel.



2.4 Remote Controller Introduction

2.4.1 Use Remote Controller

Notice: Please note that Remote Controller is not a standard part of this DVR. Your package might not include it.

Steps of using the Remote Controller are described as below:

STEP1 Put the battery into the Remote Controller.

1. Open the battery cover of the Remote Controller.
2. Put into two AAA batteries whose model is 7 and make sure that they are not inserted upside down.
3. Put back the battery cover.

STEP2 Check the followings if the Remote Controller does not work.

- Whether the battery's anode and cathode are in the correct position or not.
- Whether the power of the battery is ran out or not.
- Whether there is barrier between the Remote Controller and DVR or not.
- Whether there are some signals which transmitted by other devices disturbing the Remote Controller or not.

Notice: If the possibilities above are excluded, please contact with vendor to change the Remote Controller.

2.4.2 Facie of Remote Controller

The entire facie of the Remote Controller is shown in Fig2.3 Remote Controller.

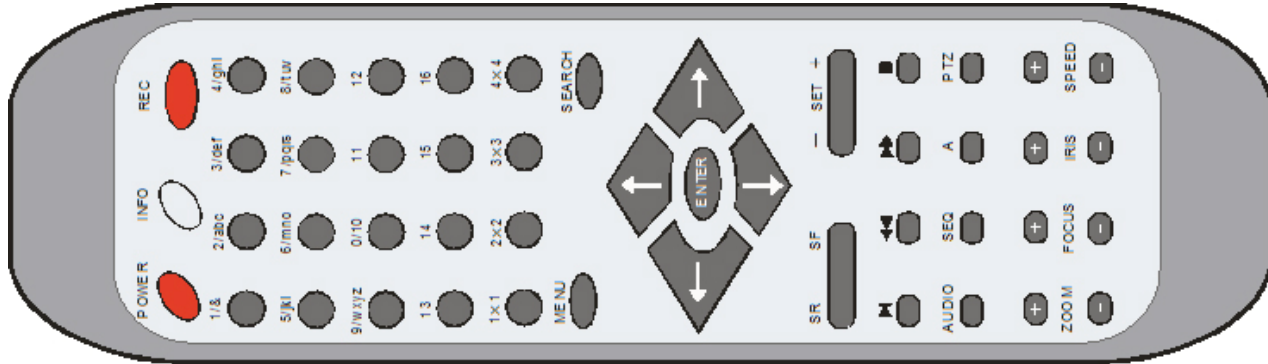





























Fig2.3 Remote Controller

All buttons on the Remote Controller describes as below table. You could use "A" button on the Remote Controller to switch the input mode.

Button	Name	Description
	POWER	Power Button Press the button to shutdown the DVR.
	REC	Record Button If the DVR does not record, press the button to start recording. If the DVR is recording, press the button to stop recording.
	INFO	Information Button Press the button to display state information of the DVR on the screen.
	1-16	Number Buttons These number buttons are used for selecting channels and other functions.
	1X1	Full-screen display mode Press the button to display the picture of single channel.

Button	Name	Description
	2X2	Four-screen display mode Press the button to display the picture of four channels. Press "1X1" button in four-screen display mode to enter the channel 1.
	3X3	Nine-screen display mode Press the button to display the picture of nine channels. Press "1X1" button in nine-screen display mode to enter the channel 1.
	4X4	Sixteen-screen display mode Press the button to display the picture of sixteen channels. Press "1X1" button in sixteen-screen display mode to enter the channel 1.
	MENU	Menu button Press the button to enter the main menu (referred Fig3.2 Main Menu). Otherwise press the button to return the previous menu or exit the menu.
	SEARCH	Search button Press the button to enter to recording search page.
	Upward	Up button Press the button to upward move the cursor.
	Leftward	Left button Press the button to leftward move the cursor.
	Rightward	Right button Press the button to rightward move the cursor.
	Downward	Down button Press the button to downward move the cursor.
	SR SF	Play for single frame button Press the left SR to go back by single frame. Press the right SF to go forward by single frame.
	-SET+	Switch for channel button Press the button to switch the channel one by one. "-" is used to display next bigger number channel, and "+" is used to display next smaller number channel. You also can switch the channel by pressing number buttons.
	Play	Play and Pause button Press the button to play record. Press the button once again to pause record.
	Fast backward	Fast reverse button Press the button to backward play the record. There are three backward multiple to choose: 2X, 4X, 8X.
	Fast forward	Fast forward button Press the button to forward play the record. There are three forward multiple to choose: 2X, 4X, 8X.

Button	Name	Description
	Stop	Stop button: Press the button to stop playing record.
	Audio switch	Audio switch button Press the button to switch the audio of the channel.
	SEQ	Sequence Button Press the button to make DVR display channels in turn.
	A	A Button Press the button to switch the mode of font form.
	PTZ	PTZ button Press the button to enter the PTZ mode.
	Zoom+/-	Zoom button Control the Fast Speed Dome to zoom-in and zoom out.
	FOCUS+/-	FOCUS button Control the focus of the Fast Speed Dome.
	IRIS+/-	Aperture button Control the input lightness of theFast Speed Dome.
	SPEED+/-	SPEED- button Control the rotational speed of the Fast Speed Dome.

The following table shows all letters which number buttons correspond.

Digital Video Recorder User Manual

Number Button	Corresponding Letter	Number Button	Corresponding Letter
1	() . @ < >	2	ABC/abc
3	DEF/def	4	GHI/ghi
5	JKL/jkl	6	MNO/mno
7	PQRS/pqrs	8	TUV/tuv
9	WXYZ/wxyz		

CHAPTER 3 Basic Operation Guide

3.1 How to Start DVR

 **Notice:** Before you power on the machine, please make sure the power input of DVR is eligible for local power supply.

If the power indicator light is off, please do as the following to start DVR:

STEP1 Connect DVR to AC adaptor and plug in.

STEP2 Turn on the DVR.

STEP3 Wait for DVR to initialize.

After the DVR is powered on, 'STARTING.....' appears on the screen, which indicates DVR is initializing.

When 'WELCOME' is displayed, you have been in live display mode. You could press "**Menu**" button to enter the Main Menu.

The symbols which are displayed on the screen are explained as following table.

Symbol	Meaning	Symbol	Meaning
LIVE	Live state	REC	Manual record
A	Sensor record	M	Motion record
DISK	Ratio of using HDD	V-LOSS	Video loss

3.2 Main Menu Setting

Steps of entering the Main Menu are described as below:

STEP1 Press "**Menu**" button and input username and password (referred Fig3.1 Login), you will see the Main Menu

(referred Fig3.2 Main Menu).

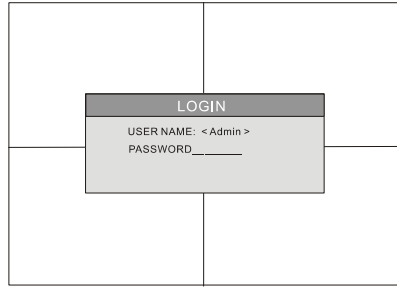

Fig3.1 Login



Fig3.2 Main Menu

STEP2 Press "Up", "Down", "Right" and "Left" buttons to move cursor, selection highlighted by yellow.

STEP3 Press "Enter" key to enter the sub-menu. And press "Menu" key to get back to Main Menu when you use the front panel to operate.

The structure of the main menu is shown in Fig3.3.

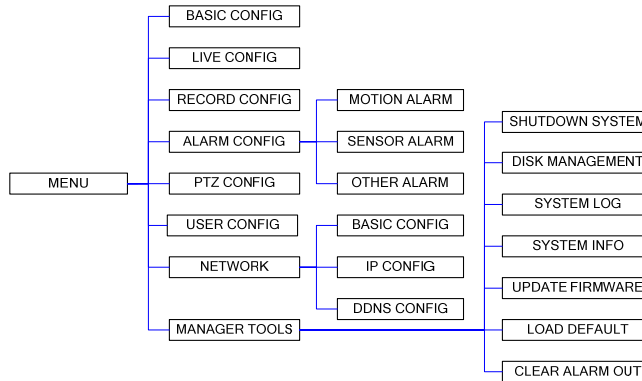

Fig3.3 Structure of Main Menu

3.2.1 Basic Configuration

Basic Configuration menu is shown as **Fig3.4 Basic Configuration**.

The screenshot shows a menu titled "BASIC CONFIG" with the following settings:

- VIDEO FORMAT: <PAL>
- TIME POSITION: <BOOTOM>
- DEVICE NAME: ABC
- DEVICE ID: 001
- DATE FORMAT: <DD/MM/YY>
- TIME ADJUST:
- BUZZER ALARM: <30 S

Fig3.4 Basic Configuration

The screenshot shows a menu titled "TIME ADJUST" with the following information:

- Date: 11-07-2007
- Time: 19:54:21
- Buttons: and

Fig3.5 Time Adjust

1. VIDEO FORMAT

After you enter the Basic Configuration menu, you need to set the video format. There are two options to choose: NTSC and PAL.

STEP1 Press "Up", "Down", "Left" and "Right" buttons to move the cursor manually.

STEP2 Press "Enter" key to change the video format.

2. TIME POSITION

You could set position of displaying time. There are three options to choose:

- TOP: Time is displayed on top of the screen.
- BOTTOM: Time is displayed at the bottom of the screen.
- NO: Do not display time on the screen.

3. DVR NAME

You could set DVR name. Range for inputting the words contents letters from 'a' to 'z' and numbers from '0' to '9'.

STEP1 Press "A" button to switch the inputting mode

STEP2 Modify the DVR name.

STEP3 Press "**Enter**" key to confirm the operation.

4. DVR ID

You could set DVR ID. It consists of three numbers.

STEP1 Press "**Up**", "**Down**", "**Left**" and "**Right**" buttons to move the cursor.

STEP2 Press "**Enter**" key to modify numbers.

STEP3 Input three numbers, and press "**Enter**" key to confirm modifying the parameter.

STEP4 Press "**OK**" button to confirm the operation.

5. DATE FORMAT

There are three options to choose:

- Asian Date format: YY/MM/DD.
- European Date format: DD/MM/YY.
- American Date format: MM/DD/YY.

6. TIME ADJUST

Time Adjust menu is shown as **Fig3.5 Time Adjust**. You must stop recording first to adjust time.

STEP1 Press "**Up**", "**Down**", "**Left**" and "**Right**" buttons to move the cursor.

STEP2 Use the numbers to modify time.

You also can use "**+**" and "**-**" button to modify time.

STEP3 Press "**Enter**" key to confirm the operation.

 **Notice:** If time that you adjust is less than current time, the record between adjusted time and current time will be delete automatically.

7. BUZZER ALARM

You could set continual time for buzzer alarm. There are seven options to choose: always, 5 seconds, 10 seconds, 30 seconds, 1 minute, 2 minutes and 4 minutes.

3.2.2 Live Configuration

Live Configuration menu is shown as **Fig3.6 Live Configuration**.



The screenshot shows a menu titled "LIVE CONFIG" with the following settings:

- CHANNEL : <CAM1>
- CHANNEL NAME : <CAM1>
- SHOW NAME :
- CHANNEL HIDE :
- BRIGHTNESS : 128 CONTRAST: 128
- SATURATION : 128 HUE : 128
- COPY CONFIG TO: <ALL>
-

Fig3.6 Live Configuration

1. CHANNEL

STEP1 Press "**Up**", "**Down**", "**Left**" and "**Right**" buttons to move the cursor.

STEP2 Press "**Enter**" key to switch the channel which you want to set.

2. CHANNEL NAME

You could set the channel name. Range for inputting the words contents letters from 'a' to 'z' and numbers from '0' to '9'.

STEP1 Press "**A**" button to switch the inputting mode.

STEP2 Input channel name.

STEP3 Press "**Enter**" key to confirm the operation.

3. SHOW NAME

If select "**SHOW NAME**" check box, the camera name will be displayed in live display mode. If unselect "**SHOW NAME**" check box, the camera name will not be displayed.

4. CHANNEL HIDE

If select "**HIDE**" check box, the picture of the channel will not be displayed in live display mode. But it is also recorded. If unselect "**HIDE**" check box, the picture will be displayed.

5. CHANNEL COLOR

Modify value of contrast, brightness, saturation and hue of the picture.

6. COPY CONFIG TO

Copy the configurations of this channel to any other selected channel.

STEP1 Select the channel which this channel will be copied to.

STEP2 Press "COPY" button.

STEP3 Press "Enter" key to confirm the operation.

3.2.3 Record Configuration

Record Configuration menu is shown as Fig3.7 Record Configuration. You could enter the menu to set the parameters of record.

RECORD CONFIG	
VIDEO RESOLUTION :	<CIF>
RECYCLE :	<input checked="" type="checkbox"/>
PRERECORD TIME :	<15 S>
TIME STAMP :	<input checked="" type="checkbox"/>
CHANNEL :	<CAM1>
VIDEO QUALITY :	<HIGHEST>
AUDIO :	<input checked="" type="checkbox"/>
SCHEDULE RECORD :	<input checked="" type="checkbox"/> SETUP
FRAME RATE SETUP :	(FPS)
MANUAL: <25>	SCHEDULE: <25>
MOTION: <25>	SENSOR : <25>
COPY TO: <ALL>	COPY
OK	CANCEL

Fig3.7 Record Configuration

SCHEDULE SETUP	
WEEKDAY :	<WEDNESDAY>
WHOLE DAY: <input type="checkbox"/>	
00:00 TO 00:00:	00:00 TO 00:00:
00:00 TO 00:00:	00:00 TO 00:00:
COPY TO: <ALL>	COPY
HOLIDAY: <07-01>	ADD DEL
WHOLE DAY: <input type="checkbox"/>	
00:00 TO 00:00:	00:00 TO 00:00:
00:00 TO 00:00:	00:00 TO 00:00:
OK	CANCEL

Fig3.8 Schedule Setup

1. VIDEO RESOLUTION

The resolution of different video format are: PAL: 352*288(CIF); NTSC: 352*240(CIF).

2. RECYCLE

If select "**RECYCLE**" check box to have continuous recording, DVR will overwrite the oldest record when HDD is full. If you unselect "**RECYCLE**" check box, the DVR will stop recording when the HDD is full.

3. TIME STAMP

If selecting the check box, record time will be displayed on the bottom of screen when playing back the record.

4. PRERECORD TIME

Prerecord time is the record time before alarm. There are two options to choose: 5 seconds and 10 seconds.

5. CHANNEL

STEP1 Press "**Up**", "**Down**", "**Left**" and "**Right**" buttons to move the cursor.

STEP2 Press "**Enter**" key to switch the channel which you want to set.

6. VIDEO QUALITY

There are five options to choose: lowest, lower, medium, higher and highest. Higher picture quality is, the picture is clearer. And the rate of using HDD is larger.

7. AUDIO

If you select "**AUDIO**" check box, DVR will record audio when it records video. Otherwise it will not record audio.

 **Notice:** When you playback the record, you can press "**AUDIO**" button to switch the sound of corresponding channel.

8. SCHEDULE RECORD

Setting of the Schedule Record is shown as Fig3.8 Schedule Setup.

STEP1 Press "**Up**", "**Down**", "**Left**" and "**Right**" buttons to move the cursor to "**SCHEDULE RECORD**" option in the Record Configuration menu.

STEP2 Select "**SCHEDULE RECORD**" check box.

STEP3 Press "**Setup**" button to enter the Schedule Setup menu.

Press "**ESC**" button on the front panel to get back to upper menu.

STEP4 In the Schedule Setup menu, press "**Up**", "**Down**", "**Left**" and "**Right**" buttons to move the cursor.

STEP5 Press "**Enter**" key to enter the time set.

STEP6 Press "**+**" and "**-**" buttons on the front panel to modify the time.

STEP7 Press "**Enter**" key to confirm the setup.

On weekday and holiday, you can select record whole day or set four periods of time to record.

9. FRAME RATE SETUP

Frame rate is the recording picture amount per second. If you choose 15, the picture recording rate is 15 frames per second.

You could set frame rate for different record mode.

If the video format is NTSC, there will be five frame rates to choose: 1, 3, 7, 15 and 30. The maximum of the frame rate is 30.

If the video format is PAL, there will be five frame rates to choose: 1, 3, 6, 12 and 25. The maximum of the frame rate is 25.

10. COPY TO

You could copy the setting of this channel to any other selected channel.

3.2.4 Alarm Configuration

Alarm Setup menu is shown as Fig3.9 Alarm Configuration. You could enter the submenu to set the parameters of the alarm.

MOTION ALARM

Motion Alarm submenu is shown as Fig3.10 Motion Alarm Configuration.

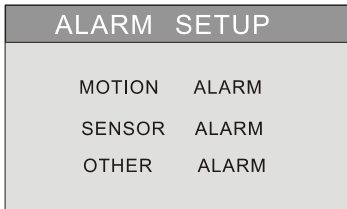

Fig3.9 Alarm Configuration

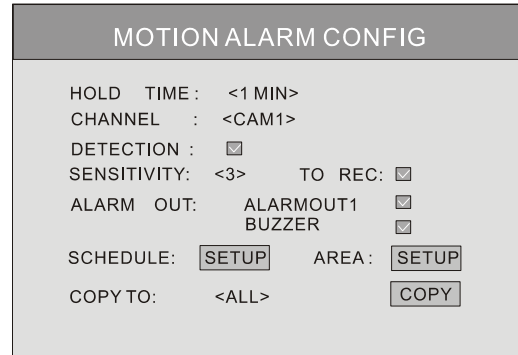

Fig3.10 Motion Alarm Configuration

1. HOLD TIME

It sets the record time after the alarm happened. There are two options to choose: 1 minute and 2 minutes. It also sets the

distant time of detecting the motion. If the HOLD TIME is 1 minute, the motion which is detected will only trigger the alarm once in 1 minute.

2. CHANNEL

STEP1 Press "**Up**", "**Down**", "**Left**" and "**Right**" buttons to move the cursor.

STEP2 Press "**Enter**" key to switch the channel which you want to set.

3. DETECTION

"**DETECTION**" checked means to motion detection activated, unchecked means to motion detection disabled.

4. SENSITIVITY

It is the sensitivity of the motion detection.

The range is from '1' to '8'. The bigger value is, the sensitivity is higher.

5. TO REC

If select "**TO REC**" check box, DVR will record when there is motion event. If not, DVR will not record.

6. ALARM OUT

There are two alarms out options to choose: ALARMOUT1 and BUZZER.

7. SCHEDULE

It is the schedule of the motion detection. The default schedule is everyday. Press "**SETUP**" button to set motion detection schedule.

8. AREA

STEP1 Press "**Up**", "**Down**", "**Left**" and "**Right**" buttons to move the cursor.

STEP2 Press "**SETUP**" button to enter the Area Setup submenu.

It shows the setting of detection area (referred Fig3.11 Detection Area Setup). The fuchsia area means to be unselected. The transparent live area means to be selected. There are four options of the Detection Area Setup to choose:

- ALL: All area will be detected.
- CUSTOM: The part which you select will be detected.
- NULL: No area will be detected.
- BACK: Go back to Motion Alarm Configuration menu.

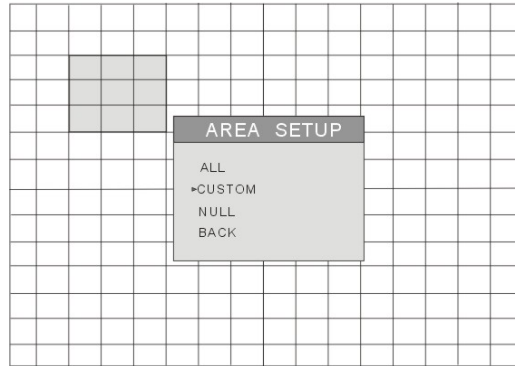



Fig3.11 Detection Area Setup

Substeps of manually selecting the detection area are described as below:

1. In the Area Setup submenu, press "**Up**" and "**Down**" buttons to choose "**CUSTOM**" option.
2. Press "**Enter**" key to confirm the operation.
3. Press "**Up**", "**Down**", "**Left**" and "**Right**" buttons to choose the part which needs to be detected.
4. Press "**Enter**" key to select or cancel the part.
5. Press "**Esc**" button to confirm the option and exit "**CUSTOM**" option.

STEP3 Press "**BACK**" option to go back the Motion Alarm Configuration menu.

 **Notice:** In Continuous recording mode, Manual Record and Alarm Record are activated at the same time. If the Alarm Record occurs, the DVR remains recording continuously. You can find the alarm event through '3.3.2 Search' function of '3 Search by Event'.

9. COPY TO

You could copy the setting of this channel to any other selected channel.

SENSOR ALARM

Sensor alarm submenu is shown as Fig3.12 Sensor Alarm Configuration. Every Sensor matches one or more channel.

SENSOR ALARM CONFIG			
HOLD TIME:	<1 MIN>		
SENSOR :	<SENSOR1>		
DETECTION :	<input checked="" type="checkbox"/>		
TYPE :	<NO>		
TRIGGER RECORD:	CAM1 <input checked="" type="checkbox"/>	CAM2 <input checked="" type="checkbox"/>	
	CAM3 <input checked="" type="checkbox"/>	CAM4 <input checked="" type="checkbox"/>	
ALARM OUT:	ALARMOUT1 <input checked="" type="checkbox"/>		
	BUZZER <input checked="" type="checkbox"/>		
SCHEDULE:			<input type="button" value="SETUP"/>
COPY TO:	<ALL>		<input type="button" value="COPY"/>
			<input type="button" value="OK"/> <input type="button" value="CANCEL"/>

Fig3.12 Sensor Alarm Configuration

1. HOLD TIME

It sets the record time after the alarm happened. There are two options to choose: 1 minute and 2 minutes. It also sets the distant time of detecting the motion. If the HOLD TIME is 1 minute, the sensor event which is detected will only trigger the alarm once in 1 minute.

2. SENSOR

STEP1 Press "Up", "Down", "Left" and "Right" buttons to move the cursor to "SENSOR" option.

STEP2 Press "Enter" key to switch the Sensor.

3. DETECTION

It is a switch of sensor alarm. If select "**DETECTION**" check box, DVR will begin detecting. If unselect "**DETECTION**" check box, the detection function is disabled.

4. TYPE

There are two options to choose: high and low. Press "Enter" key to enter the sub-menu. And there are two options to choose: NO and NC.

'NO' means normal open. If 'NO' is chosen, the DVR will alarm when the alarm is in low level.

'NC' means normal close. If 'NC' is chosen, the DVR will alarm when the alarm is in high level.

5. TRIGGER RECORD

One channel can connect to one sensor. But one sensor can match one or more channels.

STEP1 Press "Up", "Down", "Left" and "Right" buttons to move the cursor to "TRIGGER RECORD" option.

STEP2 Select the check box of the channel which sensors match.

STEP3 Press "Enter" key to confirm the operation.

For example, if you select the sensor named SENSOR1 and the trigger records named CAM1 and CAM2, it will record on channel 1 and channel 2 when the SENSOR1 is triggered.

6. ALARM OUT

There are two options to choose: ALARMOUT1 and BUZZER.

- When ALARMOUT1 is selected and the sensor is triggered, DVR will give normal alarm.
- When BUZZER is selected and the sensor is triggered, DVR will give buzzer alarm.
- When the alarm output is unselected, DVR will not send alarm.

7. SCHEDULE

It is the schedule of the sensor detection. The default schedule is everyday.

8. COPY TO

You could copy the setting of this channel to any other selected channel.

OTHER ALARM

Other Alarm submenu is shown as Fig3.13 Other Alarm Configuration. Other alarm includes video loss, disk full and so on.



Fig3.13 Other Alarm Configuration

There are two options of alarm output: ALARMOUT1 and BUZZER.

3.2.5 PTZ Configuration

PTZ Configuration menu is shown as Fig3.14 PTZ Configuration.

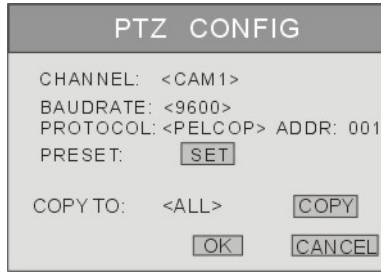

Fig3.14 PTZ Configuration

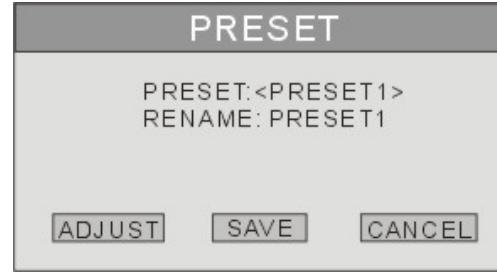

Fig3.15 Preset

1. CHANNEL

Switch to the channel which connects to the Speed Dome.

2. BAUDRATE

There are five options of baudrate to choose: 1200, 2400, 4800, 9600 and 19200.

3. PROTOCOL

Choose the PTZ protocol. Currently support protocol: PELCO_D, PELCO_P, MINKING, NEON, STAR, VIDO, DSCP, VISCA and LILIN.

4. ADDR

Set the PTZ address. Press "**Enter**" key and use the number key, "+" and "-" button to set it.

5. PRESET

STEP1 Press "**SET**" button to enter the Preset submenu which is shown as Fig3.15 Preset. There are 16 Presetting Points which could be set in every channel.

STEP2 In the Preset submenu, press "**Enter**" button to switch the Presetting Point which needs to be reset.

STEP3 Press "**ADJUST**" button to enter the PTZ mode.

STEP4 On the front panel, press "**ZOOM**", "**FOCUS**", "**SPEED**", "**IRIS**", "+" (MENU) and "-" (PTZ) buttons to modify position of the Presetting Point.

STEP5 Press "**UP**", "**DOWN**", "**RIGHT**" and "**LEFT**" buttons to rotate the Speed Dome.

STEP6 Press "**ESC**" button to come back the Preset menu.

STEP7 Press "**SAVE**" button to save the position of camera which you adjust before as Presetting Point; press "**CANCEL**" button to discard the setting to get back to upper menu.

 **Notice:** Do you know how to use the Presetting Point?

You can use the number key to switch the Presetting Point in PTZ mode. Firstly, press "**PTZ**" button to enter the PTZ mode. Then you should press the number key such as "1", the Speed Dome will move to Presetting Point 1 which you set it in front steps.

6. COPY TO

You could copy the setting of this channel to any other selected channel.

3.2.6 User Configuration

User Configuration is shown as Fig3.16 User Configuration. The default username is Admin. Admin can add users, set users' authorizations and delete users.

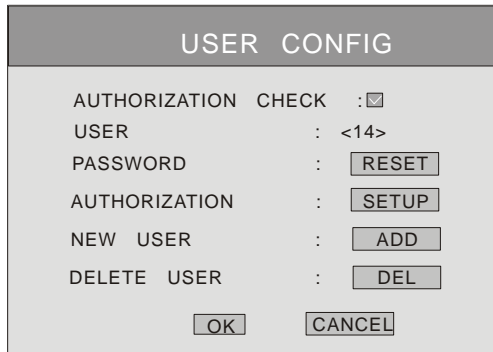

Fig3.16 User Configuration

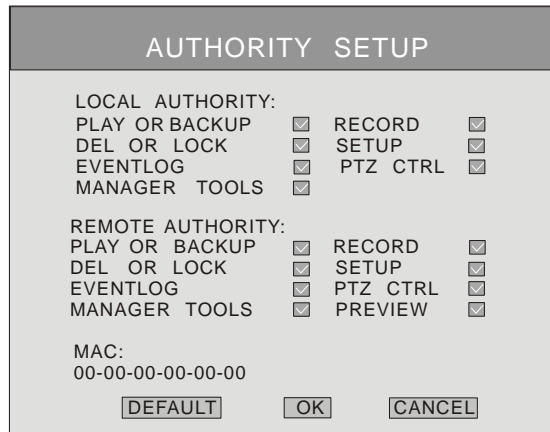

Fig3.17 Authority Setup

1. AUTHORIZATION CHECK

If select "**AUTHORIZATION CHECK**" check box, all users need input the password before entering the Main Menu.

If unselect "**AUTHORIZATION CHECK**" check box, users can enter the system directly without password.

2. USER

Press "**Enter**" key to switch to another user. Using "+" and "-" buttons could also change the user.

3. PASSWORD

Admin's password is initialized as '123456'. Users with authorization change this user's password. Password consists of numbers between 0 and 9.

4. AUTHORIZATION

STEP1 Move the cursor to "**User**" option, and press "**Enter**" key to switch the user who you want to modify authorization.

STEP2 Move the cursor to "**SETUP**" button on the screen.

STEP3 Press "**Enter**" key, Authority Setup menu (referred Fig3.17 Authority Setup) pops up.

STEP4 In the Authority Setup menu, move the cursor to the "**DEFAULT**" button.

STEP5 Press "**Enter**" key. The default authorization will be set.

The default authorization of user content:

- Live view, Playback or backup and Record in local system.
- Live view, Playback or backup and Record in remote Network Client.

5. NEW USER

STEP1 Move the cursor to "**ADD**" button on the screen.

STEP2 Press "**Enter**" key, the Add User menu will display.

STEP3 Input username and password.

STEP4 Press "**OK**" button to confirm the option.

Username can consist of numbers and letters, with 15 characters maximum. Password consists of numbers between 0 and 9.

6. DELETE USER

STEP1 Move the cursor to the "**DEL**" button on the screen.

STEP2 Press "**Enter**" key to confirm the operation. When a user is deleted, the username and password won't exist in the system any more.

3.2.7 Network Configuration

Network Configuration menu is shown as Fig3.18 Network Configuration. You could enter the submenu to set the parameters of network.

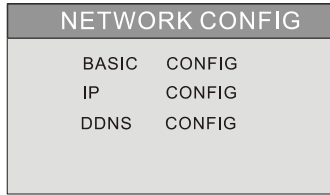

Fig3.18 Network Configuration

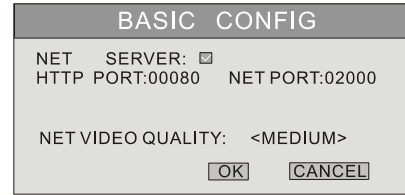

Fig3.19 Basic Configuration

BASIC CONFIGURATION

Basic Configuration submenu is shown as below Fig3.19 Basic Configuration.

- STEP1** Press "Up", "Down", "Left" and "Right" buttons to move the cursor.
- STEP2** Press "Enter" key to enter the Basic Configuration menu.

1. NET SERVER

If you select the check box and set the port number of the server, you would make the NET SERVER enable.

2. NET VIDEO QUALITY

It sets picture quality of remote surveillance. There will be three options to choose: low, medium and high. The higher quality value is, the picture is clearer.

IP CONFIGURATION

IP Configuration submenu is shown as Fig3.20 IP Configuration.

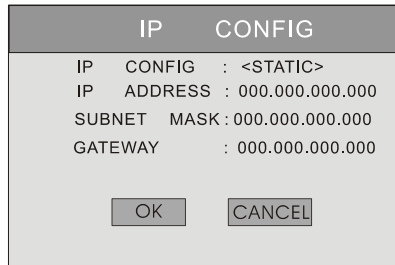

Fig3.20 IP Configuration

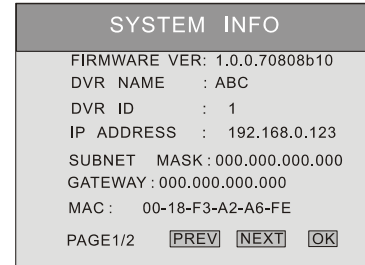

Fig3.21 System Information

It is the IP configure of the DVR. There are three options to choose: STATIC, DHCP and PPPoE.

Take Static IP address as example.

STEP1 Press "**Up**", "**Down**", "**Left**" and "**Right**" buttons to move the cursor.

STEP2 Input IP Address, Subnet Mask and Gateway.

STEP3 Press "**OK**" button to modify the IP Configuration menu.

If select DHCP, the IP address will be automatically assigned by local network. After selecting DHCP, you need to be patient for waiting 30 second. The automatic assigned IP will be displayed on the system information window.

If select PPPoE, you need to set username and password when DVR need to connect internet. If you forget username and password, Please contact with ISP.

If you press "**INFO**" button, the System Information menu can be displayed on the screen when DVR connects the network successfully (referred Fig3.21 System Information).

 **Notice:** • If the network of DVR is subjected to the following items, we recommend using Dynamic IP.

1. The local area network has DHCP server.
 2. DVR can get IP address automatically from internet.
- Before you set PPPoE, you'd better reboot the modem. After setting the PPPoE, you need wait for a while.

DDNS CONFIGURATION

DDNS Configuration submenu is shown as Fig3.22 DDNS Configuration. The DVR supports DDNS server-'88IP.net'. To Use DDNS, user need to get a domain name from the ISP whose protocol is packed in DVR.

DDNS CONFIG	
SERVER :	<www.dns2p.com>
USER NAME :	_____
PASSWORD :	_____
<input type="button" value="OK"/> <input type="button" value="CANCEL"/>	

Fig3.22 DDNS Configuration

 **Notice:** The actual ISP list may be different from each vendor.

Take the 'dns2p.com' as example to introduce. If different from the below example, please connect with your Domain Name Service Provider to be guided how to get the domain.

1. Apply the Domain Name

(1) Register in the Web

STEP1 Fill in the blank of IE address with 'www.dns2p.com'.

STEP2 Click  to enter the website.

STEP3 Click "**New User**" in the right of homepage to register. For example: User ID is 'abc', and password is '123456' (referred Fig3.23 Register Page).

[Register](#)

User ID	<input type="text" value="abc"/> *
Resolve Type	<input type="text" value="mongline"/> *
Password	<input type="password" value="*****"/> *
Confirm Password	<input type="password" value="*****"/> *
Name	<input type="text"/>
City	<input type="text"/> *
Country	<input type="text" value="Philippines"/> *
Company Name	<input type="text"/> *
E-mail	<input type="text"/> *
Address	<input type="text"/>
Code	<input type="text"/>
Tel 1	<input type="text"/> *
Tel 2	<input type="text"/>
<input type="button" value="register"/> <input type="button" value="reset"/>	

Fig3.23 Register Page

Username:

Password:

[Forget Password](#)

Fig3.24 Login Page

(2) Login

- STEP1** Return to homepage after registering successfully.
- STEP2** Click "**Account Manager**" on the right of homepage to login (referred Fig3.24 Login Page).
- STEP3** Input the username and password with the information that you have registered.
- STEP4** Click "**Enter**" key after filling in the textbox.

(3) Domain Setup

- STEP1** Click "**Domain Management**" on the left to set the domain (referred Fig3.25 Domain Setup).



Fig3.25 Domain Setup

- STEP2** Input the domain in the textbox. For example, you set 'dvr' as the domain.
- STEP3** Click "**Submit**" button, the system will pop up a dialog box to show that the domain is added successfully (referred Fig3.26 Dialog Box).



Fig3.26 Dialog Box

Notice: Time of probationary period is one month. If user wants to use it continually after one month, please click "**Buy Now**" in the right of homepage to pay for it.

2. Setup in the DVR

(1) DOMAIN

Domain is set in '1 Apply the Domain Name'. According to the example above, the domain is 'dvr.dns2p.com'.

(2) USER ID

Username of registered which is set in '(1) Register in the Web'. According to the example above, user ID is 'abc'.

(3) PASSWORD

Password is set in '(1) Register in the Web'. According to the example above, password is '123456'.

Notice: If the connection fails, press the "**INFO**" button, the system will display: 'DDNS NONE'. Then you need to check network and

information above and try again.

3. Application

STEP1 Connect DVR to the Network Client.

STEP2 After popping up the login interface, fill in "**Server**" textbox with '`*.dns2p.com`' to visit the Network Client of the DVR.

'*' is the domain which is set in '(3) Domain Setup'. According to the example above, fill in "**Server**" textbox with '`dvr.dns2p.com`'.

3.2.8 Manager Tools

Manager Tools menu is shown as Fig3.27 Manager Tools. You could enter the submenu to set the parameters of network.

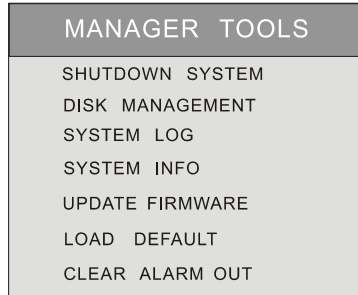

Fig3.27 Manager Tools

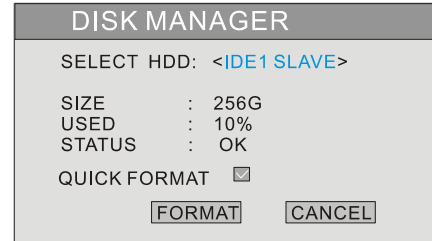

Fig3.28 Disk Management

SHUTDOWN SYSTEM

You could shut down system through this function.

STEP1 Press "**Up**", "**Down**", "**Left**" and "**Right**" buttons to move the cursor for entering the SHUTDOWN submenu.

The following words will be shown: 'ARE YOU SURE TO SHUT DOWN DVR SYSTEM?'.

STEP2 Press "**Enter**" key to confirm the operation.

DISK MANAGEMENT

Disk Management submenu is shown as Fig3.28 Disk Management. There are two options to choose: FORMAT and CANCEL.

1. QUICK FORMAT

STEP1 Press "Up", "Down", "Left" and "Right" buttons to move the cursor.

STEP2 Select "QUICK Format" check box.

2. FORMAT

STEP1 Press "Up", "Down", "Left" and "Right" buttons to move the cursor.

STEP2 Select "FORMAT" button.

STEP3 Press "Enter" key, a hint will pop up: 'FORMAT WILL ERASE ALL DATA ON THIS HDD! FORMAT NOW?'

STEP4 Press "OK" button to format the HDD; Press "CANCEL" or "ESC" button to cancel this operation.

Notice: • If HDD is used for the first time, system will remind user to format the HDD when the DVR started up. And HDD could record after the HDD is formatted.

• Before you format the HDD, you must stop recoding and playing back.

• Time for formatting the HDD is subjected to the HDD capability. The bigger capability is, the time is longer. Normally, a 40G HDD takes about eighty seconds to format.

SYSTEM LOG

System log submenu is shown as Fig3.29 Log Search. You could inquire the operation log on DVR. The DVR will note the operation, status and time automatically when the DVR is working. After enter the submenu, you need to select the operation and status type which you need to inquire.

LOG SEARCH			
LOCAL: LOGIN:	<input checked="" type="checkbox"/>	CONFIG	<input checked="" type="checkbox"/> PB <input checked="" type="checkbox"/>
PTZ :	<input checked="" type="checkbox"/>	DEL LOCK	<input checked="" type="checkbox"/>
NET: LOGIN:	<input checked="" type="checkbox"/>	CONFIG	<input checked="" type="checkbox"/> PB <input checked="" type="checkbox"/>
PTZ :	<input checked="" type="checkbox"/>	DEL LOCK	<input checked="" type="checkbox"/>
OTHER: SYS:	<input checked="" type="checkbox"/>	VLOSS:	<input checked="" type="checkbox"/> DISK <input checked="" type="checkbox"/>
START TIME:	11-08-2007	00:00:00	
END TIME:	11-08-2007	22:00:00	
		<input type="button" value="OK"/>	<input type="button" value="CANCEL"/>

Fig3.29 Log Search

SYSTEM INFO	
FIRMWARE VER:	1.0.0.70808b10
DVR NAME :	ABC
DVR ID :	1
IP ADDRESS :	192.168.0.123
SUBNET MASK :	000.000.000.000
GATEWAY :	000.000.000.000
MAC :	00-18-F3-A2-A6-FE
PAGE1/2	<input type="button" value="PREV"/> <input type="button" value="NEXT"/> <input type="button" value="OK"/>

Fig3.30 System Information

1. TYPE

Types of the log file. Move the cursor to the log file types which you want to inquire, press "**Enter**" key to select the types. The default setting is select all types. For example:

2. TIME

Beginning time and ending time of the log file.

STEP1 Select types of the log.

STEP2 Select start time and end time.

STEP3 Press "**Up**", "**Down**", "**Right**" and "**Left**" buttons to move cursor.

STEP4 Press "**OK**" button to view the event log; Press "**CANCEL**" or "**ESC**" button to cancel this operation.

The information of log files content start time, end time and log file types. For example: 110707:092151 means 2007-7-11 9:21:51 and N-L means the LOGIN of the NET.

If there are too much log list, user can use "**PREV**" button to page up and use "**NEXT**" button to page down.

SYSTEM INFORMATION

System information submenu is shown as Fig3.30 System Information. It displays the information about the system, such as firmware version, device name, DVR IP ADDRESS, Client information and so on.

Press the "**INFO**" button on the front panel, it will display the system information on the screen.

UPDATE FIRMWARE



Fig3.31 Update Firmware

Update Firmware submenu is shown as Fig3.31 Update Firmware. You could use USB disk to update the firmware. Before using USB disk to update, please make sure the firmware is in the USB disk. Steps are described as below.

STEP1 Make sure the updating firmware is in the USB disk.

- STEP2** Enter the menu after word-'USB' is displayed on the live mode.
- STEP3** Press "**Up**" and "**Down**" buttons to move the cursor on "**UPDATE**" button.
- STEP4** Press "**Enter**" key to start updating.
Process of backup is shown as Fig3.32 Updating.



Fig3.32 Updating

- STEP5** After the program checked is done, the system will restart.
If DVR reboot normally, DVR is updated.

LOAD DEFAULT

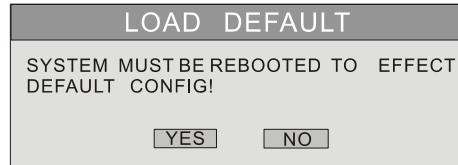

Fig3.33 Load Default

Load Default menu is shown as Fig3.33 Load Default. It loads the factory default setup.

CLEAR ALARM OUT

Clear the current alarm out, referred Fig3.34 Clear Alarm Out.

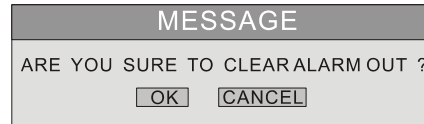

Fig3.34 Clear Alarm Out

3.3 Shortcut Menu

3.3.1 PTZ

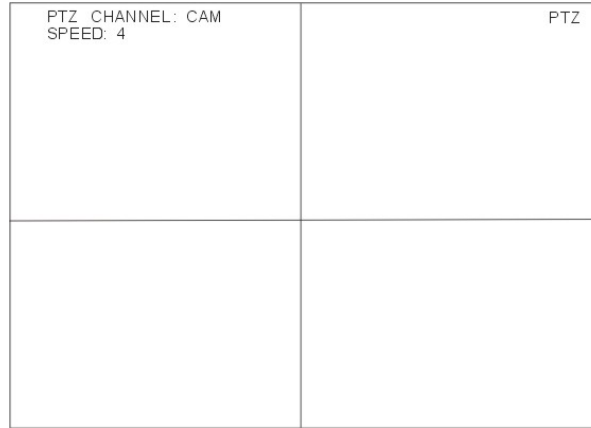

Fig3.35 PTZ Mode

PTZ mode is shown as Fig3.35 PTZ Mode. In order to switch the channel to which connects the video output of the Speed Dome, you may press "**PTZ**" button to enter the PTZ mode.

In the live view of PTZ mode, the default channel is channel 1, you can use Remote Controller to change the channel number to enter the corresponding channel PTZ mode.

SPEED

STEP1 In PTZ mode, press "**Speed**" button.

STEP2 Press "+" and "-" buttons to change the rotational speed.

STEP3 Press "**Up**", "**Down**", "**Left**" and "**Right**" buttons to rotate the Speed Dome to certain position.

ZOOM

STEP1 In PTZ mode, press "**ZOOM**" button.

STEP2 Press "+" and "-" buttons to zoom in and zoom out.

FOCUS

- STEP1** In PTZ mode, press "**FOCUS**" button.
STEP2 Press "+" and "-" buttons to control focus.

IRIS

- STEP1** In PTZ mode, press "**IRIS**" button.
STEP2 Press "+" and "-" buttons to control little and much light of the Speed Dome.

3.3.2 Search

Press the "**Search**" button, there are five submenus displayed on the screen: PLAYBACK, BACKUP, DELETE and LOCK. Data menu is shown as Fig3.36 Data.

PLAYBACK

1. Select the Date

- STEP1** In Data menu, press "**Up**" and "**Down**" buttons to move the cursor.
STEP2 Press "**Enter**" key to enter the Calendar submenu.

DATA
PLAYBACK
BACKUP
DELETE
LOCK

Fig3.36 Data

CALENDAR						
<< < 07-2007 > >>						
SUN	MON	TUE	WED	THU	FRI	SAT
1	2	3	4	5	6	7
8	9	10	11	12	13	14
15	16	17	18	19	20	21
22	23	24	25	26	27	28
29	30	31				

Fig3.37 Calendar

Calendar submenu is shown as Fig3.37 Calendar.

 **Notice:** You can search the record which you need by time search or event search. The time displayed in red has record file.

2. Search by Time

All the record can be searched through this function. Steps of search by time as below:

- STEP1** In Calendar submenu, press "**Up**", "**Down**", "**Right**" and "**Left**" buttons to select date.
- STEP2** Press "**Enter**" key to enter the Playback submenu, referred Fig3.38 Playback.
- STEP3** Press "**Enter**" key to select channels.
- STEP4** Press "**Up**", "**Down**", "**Right**" and "**Left**" buttons to select time of the date which you select ahead. The time in red has record file. The first line is hour, and the second line is minute.
- STEP5** Press "**Up**", "**Down**", "**Right**" and "**Left**" buttons to move the cursor, and select the "**PLAY**" button.
- STEP6** Press "**Enter**" key to play the record.

 **Notice:** • It just supports playing back in large picture mode. You may use "**Up**", "**Down**", "**Left**" and "**Right**" buttons to switch the channels.
 • When you play back the record, you may press "**INFO**" button on the front panel to play or stop channel audio.

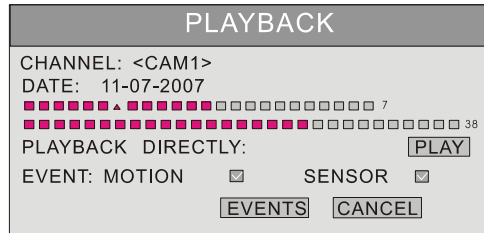

Fig3.38 Playback

3. Search by Event

You could search the motion detection records and sensor alarm records through searching by event. Steps of searching the event as below:

- STEP1** In Playback submenu, select the camera and date. The date which has event record is highlighted in red.
- STEP2** Press "**Up**", "**Down**", "**Right**" and "**Left**" buttons to move the cursor to event option.
Event search types: MOTION and SENSOR.
- STEP3** Press "**Down**" button to move the cursor to "**EVENTS**" button in the submenu.
- STEP4** Press "**Enter**" key to enter the event list.
- STEP5** Analyze the list information.
Take one of the event records information as example. Meaning of the words is described as below:
 - CH: Channel.
 - START TIME: The start time of the record.

- TYPE: The type of the event. There are two types of event: MOTION and SENSOR.
- M: Motion detection.
- A: Sensor detection.
- LOCK: Lock status of files.

STEP6 Press "**Up**" and "**Down**" buttons to choose the event record.

STEP7 Press "**Enter**" key to play back the record which is chosen.

STEP8 Press "**Stop**" button to get back to live display mode.

 **Notice:** If event list is over a page, use "**PREV**" and "**NEXT**" buttons to view next page.

BACKUP&VIEW BACKUP

1. BACKUP

Select the Backup submenu in the Data menu to enter the Backup submenu which is shown as Fig3.39 Backup.

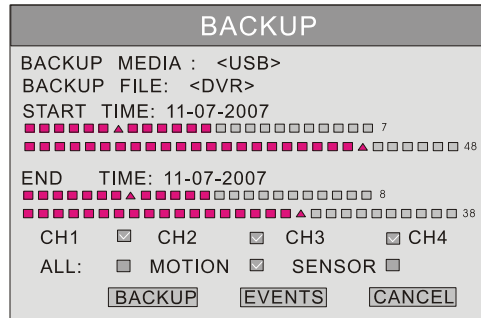

Fig3.39 Backup

(1) BACKUP MEDIA

Press "**Enter**" button to modify the backup media which would backup the record. There are five options to choose: DVD-R, DVD-RW, DVD+R, DVD+RW and USB disk. They connect with DVR through USB interface.

(2) BACKUP FILE

It selects the format of backup file. It supports AVI and DAT video format. When you select DVR, the video format of backup file will be DAT.

(3) START TIME

Start recording time to backup. The first line is hour, and the second line is minute. You must choose the date firstly and choose the time secondly.

(4) END TIME

End recording time to backup. The first line is hour, the second line is minute. You must choose the date firstly and choose the time secondly.

(5) CHANNEL

If you want to backup one or more channels, please select the channels which you want to backup.

(6) EVENTS

There are two options to choose: motion and sensor. If you want to backup all records, please select "ALL".

(7) BACKUP

After selecting of BACKUP MEDIA, BACKUP FILE, CHANNEL, START TIME, END TIME and EVENTS, DVR is ready to backup.

STEP1 Enter the menu after word-'USB' is displayed on the live mode.

STEP2 Press "**BACKUP**" button, the backup information of DVR will display on the screen (referred Fig3.40 Backup Information).

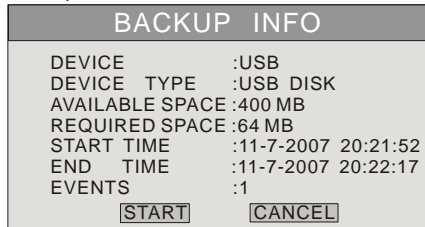

Fig3.40 Backup Information

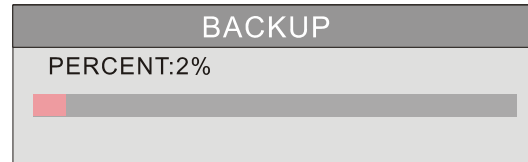

Fig3.41 Backup Progress

STEP3 Press "**START**" button, backup starts.

Backup progress will be displayed on screen, as Fig3.41 Backup Progress. If you stop recording when you backup the record files, the backup speed will be faster.

STEP4 When the backup is over, the system will pop up a dialog box. The sentence in the dialogue is as following:

'BACKUP COMPLETELY'.

So far, the backup is completed.

2. VIEW BACKUP

If backup with AVI format, most media player can view directly.

If backup with DVR format, please use the client software to view.

(We also supply extra software, DVR player, which can play AVI and DVR format, it is suggested to utilize DVR player to play both format recordings).

DELETE

Delete submenu is shown as Fig3.42 Delete. You can delete the selected record in the Delete submenu.

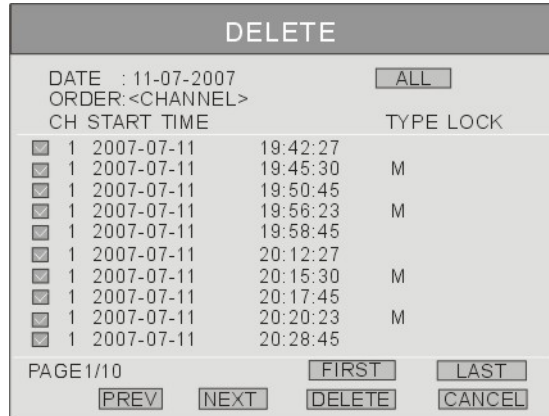

Fig3.42 Delete

STEP1 In Data menu, press "**Up**", "**Down**", "**Right**" and "**Left**" buttons to move the cursor, the submenu selected will be displayed in yellow.

STEP2 Press "**Enter**" key to enter the Delete submenu.

STEP3 In the Delete submenu, use "**UP**" and "**DOWN**" buttons to move the cursor.

STEP4 Press "**Enter**" key to select the record.

- STEP5** Move the cursor to "**DELETE**" button and press "**Enter**" key, information will be given as below:
'SOME RECORDS WILL BE DELETED, CONTINUE?'
- STEP6** Press "**Left**" and "**Right**" buttons to select "**OK**" button.
- STEP7** Press "**Enter**" key to delete this record.

LOCK/UNLOCK

Lock submenu is shown as Fig3.43 LOCK/UNLOCK. It uses to lock or unlock the record.

LOCK				
DATE : 11-07-2007				
ORDER:<CHANNEL>				
CH	START TIME		TYPE	LOCK
1	2007-07-11	19:42:27		
▶ 1	2007-07-11	19:45:30	M	LOCK
1	2007-07-11	19:50:45		
1	2007-07-11	19:56:23	M	
1	2007-07-11	19:58:45		LOCK
1	2007-07-11	20:12:27		
1	2007-07-11	20:15:30	M	
1	2007-07-11	20:17:45		LOCK
1	2007-07-11	20:20:23	M	
1	2007-07-11	20:28:45		

PAGE 1/10

Fig3.43 LOCK/UNLOCK

Use "**Enter**" key to change the state. If the record event is locked, the record can not be deleted and overwritten.

3.3.3 Information

Press the "**INFO**" button, there will be some information appearing on the screen. For example, HDD quantity, usable rate of HDD, record mode including manual/alarm/motion etc.

3.3.4 Other

- In live display mode, if you press the "**Up**" button, it will display the first channel in full screen.
- If you press the "**Down**" button, it will display the second channel in full screen.

- If you press the "**Left**" button, it will display the third channel in full screen.
- If you press the "**Right**" button, it will display the fourth channel in full screen.
- If you press the "**Enter**" button, it will display the four-divided channel.
- If you press the "**Audio**" button, it will switch the voice for corresponding channel in live display mode.

CHAPTER 4 Remote Surveillance

4.1 Accessing DVR

Because our DVR supports IE control, you need use IE connect to DVR and download and install ActiveX controls for remote controlling the DVR.

Before remote controlling the DVR, you need right connect the DVR and cable to internet. If you access the DVR through WAN, you need to set DVR and router parameters firstly.

DVR could support five users logging in and operating the Network Client synchronously.

4.1.1 Accessing DVR in LAN

When your computer is connected in LAN, you can access DVR according to following steps for using IE browser.

STEP1 Double-click the IE browser icon to open the IE browser.

STEP2 Input the IP address in IE textbox and press "**Enter**" key.

STEP3 Install ActiveX controls in displayed page.

STEP4 After finishing installing, the system will connect to DVR automatically. It will display Network Client interface, referred Figure4-1 Network Client Interface.

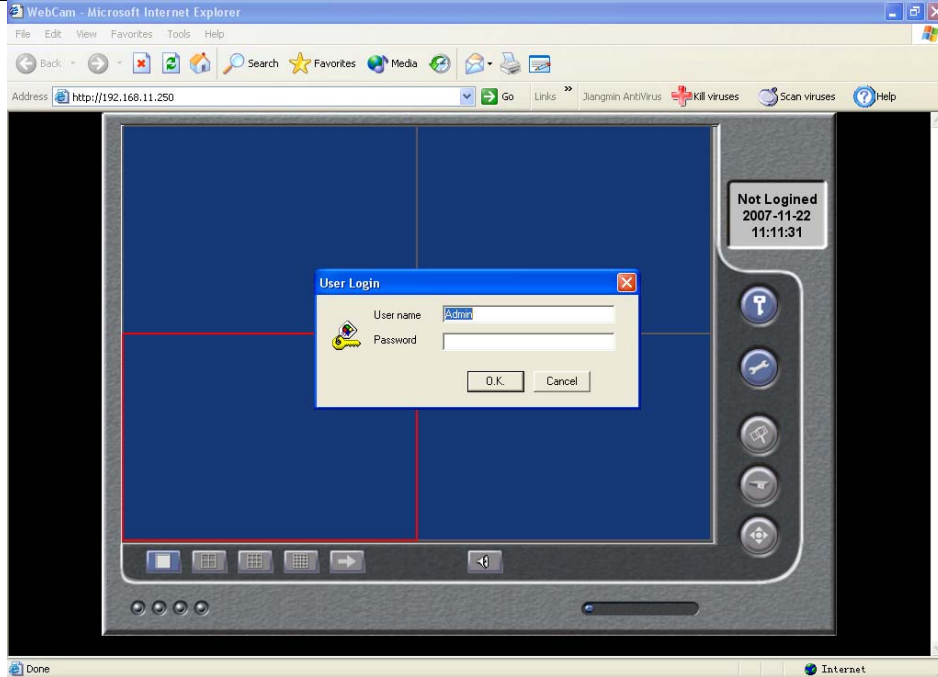

Figure4-1 Network Client Interface

4.1.2 Accessing DVR in WAN

When you access DVR in WAN, you need to set safety certificate firstly.

STEP1 Double-click the IE browser icon to open the IE browser.

STEP2 Select 'tools > Internet Options' in menu bar, it will pop up "**Internet Options**" window, referred Figure4-2 Internet Options.

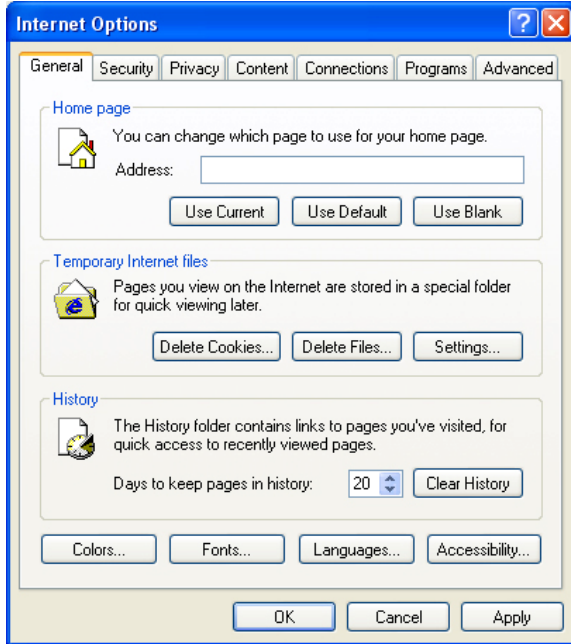

Figure4-2 Internet Options

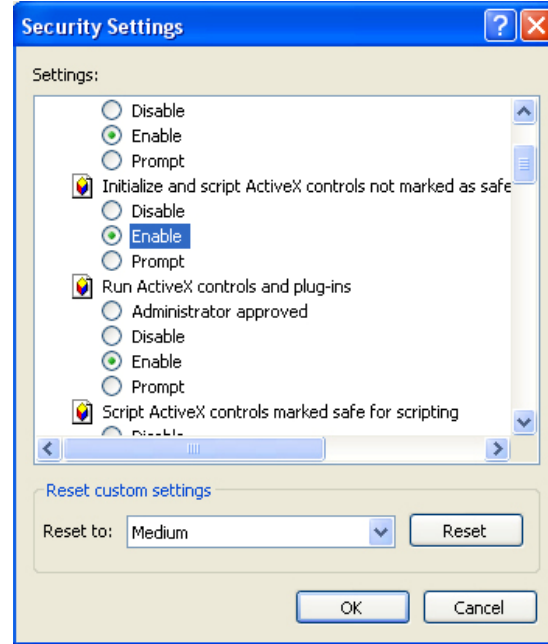

Figure4-3 Security Settings

STEP3 Click "**Security**" option, and click "**Custom Level...**" in "**Security level for this zone**", it will pop up "**Security Settings**" window, referred Figure4-3 Security Settings.

STEP4 In "**Security Settings**" window, enable the options which relate with ActiveX controls.

STEP5 Click "**OK**", finish setting the parameters.

STEP6 Input IP of the DVR in IE textbox, then press "**Enter**" key.

STEP7 Install ActiveX controls automatically in displayed page.

STEP8 The system access DVR automatically after finishing installation. The Network Client interface will be displayed in IE browser, referred Figure4-1 Network Client Interface.

Notice: When the Network Client is running on VISTA operation system, you also need set relational ActiveX parameters. Steps of setting parameters are shown as follows:

1. Open IE browser, then select 'Internet Options > Advanced > Security'.
2. Enable 'Allow software to run or install even if the signature is invalid' and 'Allow active content to run in files on my computer'.
3. Click "OK" to finish the settings.

4.2 Main Interface

The function button of the remote surveillance is shown as Fig4.2 Main Interface.



Fig4.2 Main Interface

4.2.1 Login

The operation of the Network Client is the same as the DVR. Default username is 'Admin' and password '123456'.

STEP1 Click  button to input username and password in the pop-up box.

STEP2 Press "**Enter**" key to login.

 **Notice:** Click "**EXIT**" button, you could exit the system.

4.2.2 Snap Picture

Snap live picture. Press  to snap the picture.

4.2.3 Parameter Settings

Parameter Settings window could set the amount how many picture you snap once. If you select 5, you can snap five pictures every time when you click "**Snap Picture**" button.

4.2.4 Record

STEP1 Click "**DVR Record**" button.

STEP2 Select "**Start Record**" in drag-down list to record.

STEP3 Select "**Stop Record**" in drag-down list to stop recording.

4.2.5 Camera Audio

You could set to open or close the camera audio.





STEP1 When you are in live display mode or playback mode, select a channel to display in Large Picture mode.

STEP2 Right-click the picture, and select "**Open Audio**" to play the camera audio.

STEP3 Click  button to turn up or turn down the audio.

4.2.6 DVR Status Panel

Meaning of the colors for indicator lights in the Main Interface are shown as below:

1.  Grey indicator light: Normal State.
2.  Green indicator light: Manual Record State.
3.  Yellow indicator light: Motion Detection Record State.
4.  Red indicator light: Sensor Alarm Record State.
5.  Blue indicator light: Video Loss State.

4.3 Remote Playback and Search

4.3.1 Remote Playback

Click  button in the Main Interface to enter the following area which is shown as Fig4.3 Remote Playback.

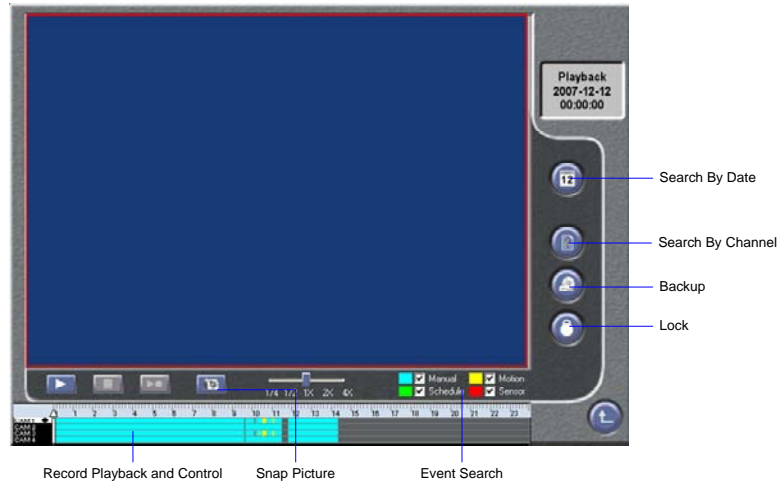

Fig4.3 Remote Playback

Meaning of the function button in the Remote Playback window is shown as below:



1.  : Play /Pause.
2.  : Stop.
3.  : Next frame. This button will be valid when playback is paused.
4. You can select suitable speed for playing record in the area as Fig4.4 Multiple of Playing.



Fig4.4 Multiple of Playing

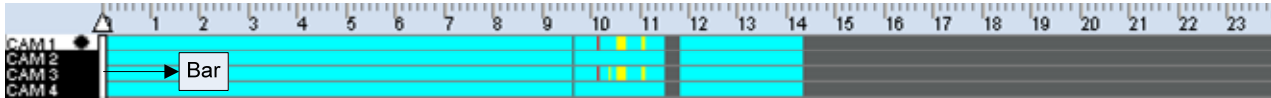



Fig4.5 Data Preview

Fig4.5 Data Preview shows the record data of different channels in corresponding time. In the figure, left side shows the available channels. When certain channel has been selected for playback, the background color will be highlighted and '▲' sign will appear beside the channel title.

The data preview area at the center gives details of the record files. Different colors of the bar show different types of records. The following are the definitions of the color bars:

- | | |
|--|---|
|  Blue: Manual Record Events |  Green: Schedule Record Events |
|  Yellow: Motion Detection Record Events |  Red: Sensor Alarm Record Events |

The ruler on top of the bar shows the hours in whole day. Right-click the ruler, it will be magnified 10 multiples. Therefore users can see the time marks in details.

STEP1 When you search for a certain section of record, draw the bar to the desired position. If necessary, right-click the bar to see the magnified time marks for precise search.

STEP2 Click  button to play the selected record. When you return to live display mode after finishing remote playback, it will display word-'connect...' sometimes on the screen. And you may click "**Large Picture**" or "**Quad Picture**" button to fresh screen to get live picture.

4.3.2 Other Functions

BACKUP

Click  button to enter the Backup window which is shown as Fig4.6 Backup.

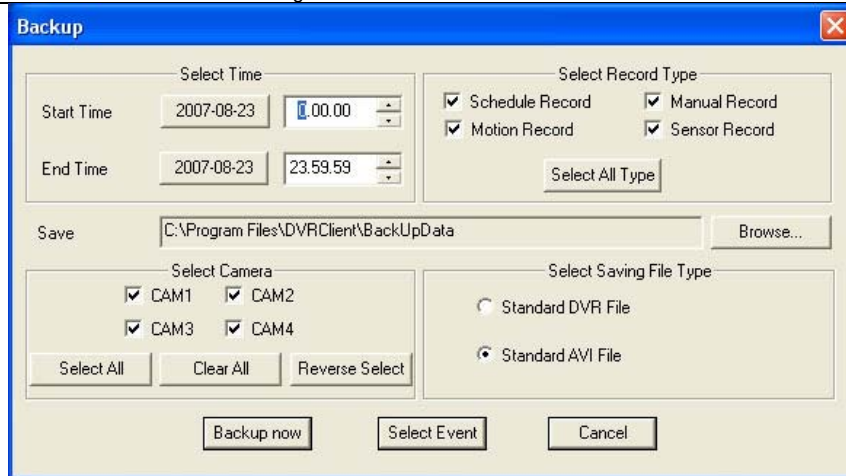

Fig4.6 Backup

There are two methods of backup: backup by time and backup by event.

1. TIME BACKUP

- STEP1** Select the time and record type.
- STEP2** Select the camera.
- STEP3** Press "**Browse...**" button to select the folder of saving the Backup file.
- STEP4** Select cameras which you want to backup.
- STEP5** Select the type of backup file.
- STEP6** Click "**Backup Now**" button, backup progress pops up.

2. EVENT BACKUP

- STEP1** Select the time and record type.
- STEP2** Select the camera.
- STEP3** Press "**Browse...**" button to select the folder of saving the Backup file.
- STEP4** Select cameras which you want to backup.

STEP5 Select the type of backup file.

STEP6 Click "**Select Event**" button to enter the Select Event window which is shown as Fig4.7 Select Event.

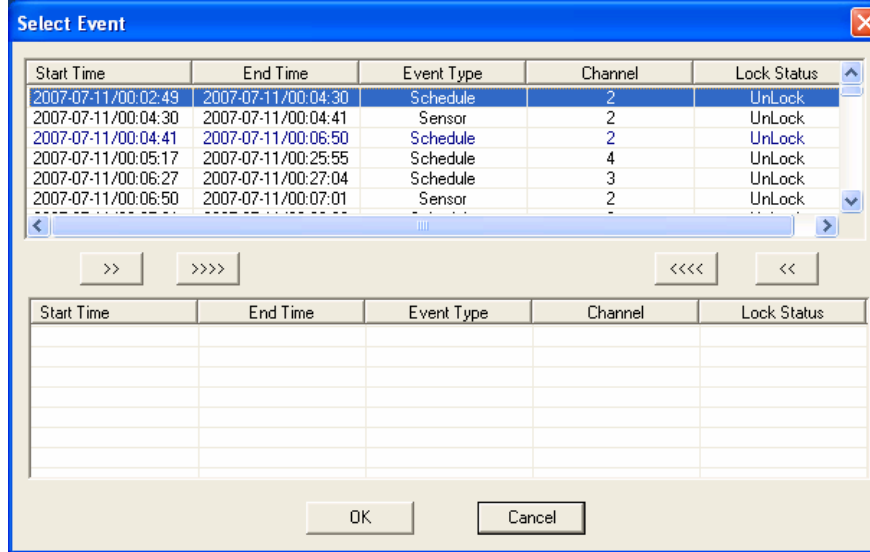

Fig4.7 Select Event

1. Choose event list and press ">>" button to move to backup list, showed in the box under; Click ">>>>" to choose all events.
2. Choose event list and press "<<" button to clear selected event; click "<<<<" button to clear all events.

STEP7 Click "**OK**" button to run the backup.

LOCK /UNLOCK

You could select the record which you want to lock/unlock.

STEP1 Click  button to enter the Remote Lock window, as Fig4.8 Remote Lock.

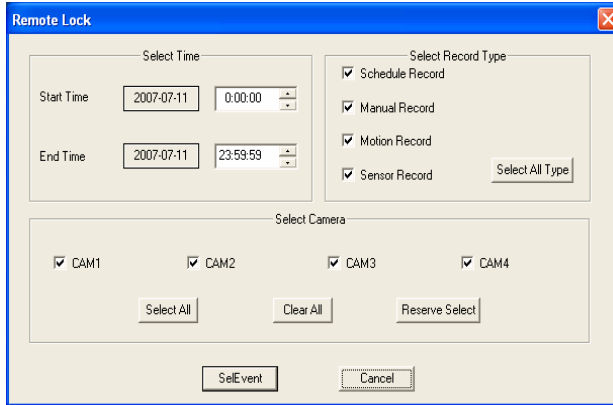

Fig4.8 Remote Lock

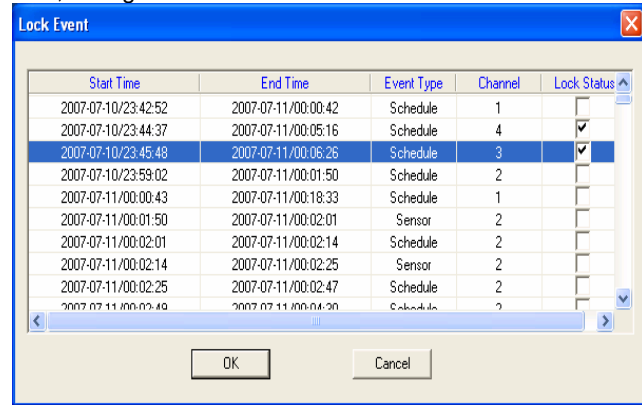

Fig4.9 Lock Event

STEP2 Select the time and record type.

STEP3 Select the camera.

STEP4 Click "Select Event" button, system find the corresponding event and it will pop up the LOCK EVENT window which is shown as Fig4.9 Lock Event.

STEP5 Select the check box can change the lock status.

Lock Status shows '√' to indicate that the event is locked, otherwise it means unlock.

STEP6 Click "OK" button to confirm the operation in the Lock Event interface.

4.4 Remote DVR Configuration









Click  button in the Main Interface to enter the following interface which is shown as Fig4.10 Remote DVR Configuration.



Fig4.10 Remote DVR Configuration

The definitions of the buttons in Fig4.10 are as below:

- | | | | | | |
|---|----------------------|---|--------------------|---|----------------------|
|  | System Configuration |  | Live configuration |  | Record Configuration |
|  | Alarm Configuration |  | PTZ Configuration |  | User Configuration |
|  | Manage Tools |  | Return | | |

The Remote DVR Configuration can set the configurations of the DVR remotely. The operation is the same as DVR. It can change the configuration of DVR.

4.4.1 Basic Configuration



Click  button in the Remote DVR Configuration and enter the Basic Configuration which is shown as below Fig4.11 Basic Configuration.

After you change parameters of the Basic Configuration window, click "OK" button, the setting will be saved and inured on the DVR.

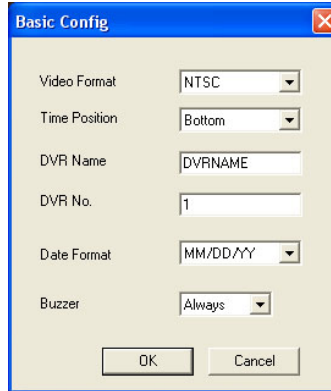
A screenshot of a dialog box titled "Basic Config" with a blue title bar and a red close button. The dialog box has a light beige background and contains several configuration options. Each option consists of a label on the left and a control on the right. The controls include dropdown menus and text input fields. At the bottom of the dialog box are two buttons: "OK" and "Cancel".

Video Format	NTSC
Time Position	Bottom
DVR Name	DVRNAME
DVR No.	1
Date Format	MM/DD/YY
Buzzer	Always

Fig4.11 Basic Configuration

1. Video Format

Select the option in the drag-down list to change the video format of DVR. There are two video format : PAL and NTSC.

2. Time Position

Select the option in the drag-down list to change the time position that displays on the DVR.

3. DVR Name

Input words to change the name of DVR.

4. DVR No.

When you have more than one DVR, you can give a number to every DVR.

5. Date Format

Select the option in the drag-down list to change the format of date. There are three date format : YY/MM/DD、DD/MM/YY 和 MM/DD/YY.

6. Buzzer

Select the option in the drag-down list to change the time how long the buzzer will last.

4.4.2 Live Configuration

Click  button in the Remote DVR Configuration, the drag-down menu will appear. There are the Live Configuration window and Color Settings window which are shown as below Fig4.12 Live Configuration and Fig4.13 Color Settings.



Fig4.12 Live Configuration

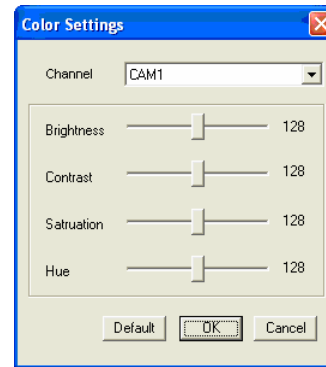

Fig4.13 Color Settings

LIVE CONFIGURATION

1. Channel

Select the option in the drag-down list to change the channel of camera.

2. Channel Hide

Select the check box to change be hidden or shown the picture of DVR channel in the live display mode.

3. Show Name

Select the check box to change be hidden or shown the name of DVR channel in the live display mode.

4. Channel Name

Input words to change the name of the channel.

COLOR SETTINGS

1. Channel

Select the option in the drag-down list to change the channel of DVR.

2. Brightness /Contrast /Saturation /Hue

You can set suitable brightness, contrast, saturation and hue for every channel by drawing the slider.

4.4.3 Record Configuration

Record Configuration window is shown as Fig4.14 Record Configuration.

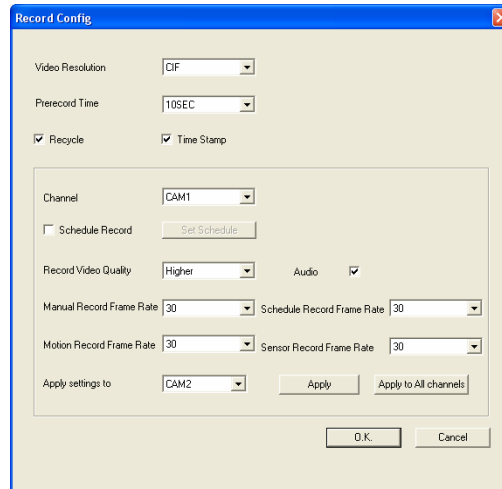

Fig4.14 Record Configuration

1. Parameter Settings

The setting is the same as '3.2.3 Record Configuration' of the DVR. If you change it on Network Client, the DVR will change along with it.

2. Schedule Record

The default value of Schedule Record is not active.

STEP1 Click the check box of the Schedule Record, it will be active. The default schedule time is every day.

STEP2 Click the "Set Schedule" button, the Schedule Configuration window will pop up as Fig4.15 Schedule Configuration.

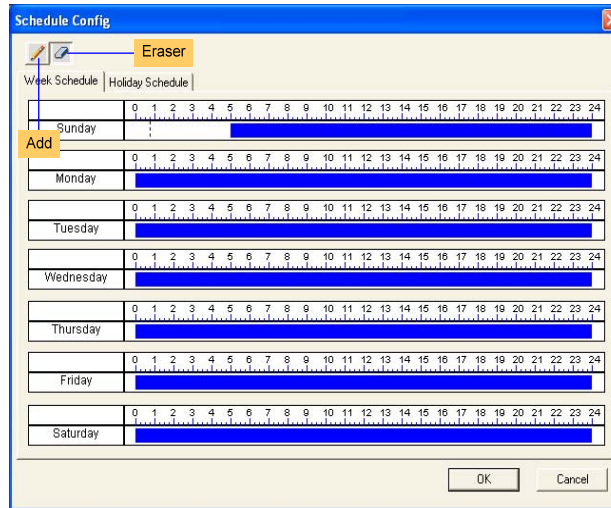



Fig4.15 Schedule Configuration

STEP3 Click "Eraser" button and click on the weekday schedule to delete the time; Click "Add" button and click on the weekday schedule to add the time.

4.4.4 Alarm Configuration



Click  button in the Remote DVR Configuration, the drag-down menu will appear. There are Motion Alarm window, Sensor Alarm window and Other Alarm window. The setting is the same as '3.2.4 Alarm Configuration' of the DVR. If you change it here, the DVR will change along with it.

4.4.5 Network Configuration



Click  button to change the video quality of the Network Client in the Network Configuration window.

4.4.6 User Configuration

The setting of User Configuration window is the same as '3.2.6 User Configuration' of the DVR. The added users in the server can login the Server and Client.

4.4.7 Manage Tools



Click  button in the Remote DVR Configuration, the drag-down menu will appear. There are Disk Management window, Software Update window, Load Default window, System Information window and System Log window.

DISK MANAGEMENT

It displays the information of hard disk.

SOFTWARE UPDATE

DVR firmware can be updated remotely through Network Client software.

STEP1 Select the path of updating file.

STEP2 Click the "**Start**" button, the updating progress will appear. The Update dialog box is shown as Fig4.16 Software Update.

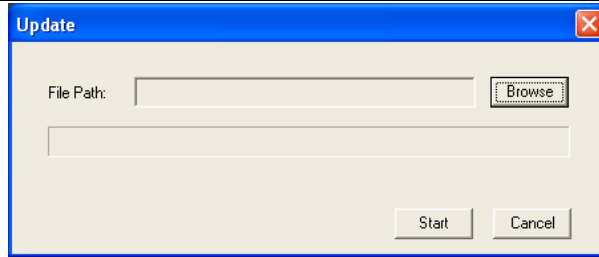

Fig4.16 Software Update

STEP3 After update finishing, DVR need to be rebooted to apply the new firmware.

LOAD DEFAULT

Load default setup.

SYSTEM INFORMATION

It displays the information of the DVR, such as version, DVR name and MAC address and so on.

SYSTEM LOG

It displays the information about operating information on the DVR.

4.5 Remote PTZ

PARAMETERS

Before operating the Remote PTZ, you should set the PTZ configuration. PTZ Configuration window is shown as Fig4.17 PTZ Configuration.

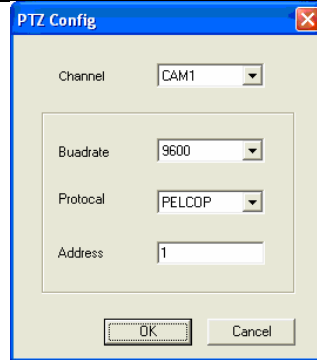
**Fig4.17 PTZ Configuration**

1. Channel

When you need to set PTZ control, you should enter the PTZ configuration window and click the corresponding channel. Then users can begin to control the PTZ through enabled channel.

2. Baud Rate

It sets the Baud Rate of PTZ device. The default value is 9600.

3. Protocol

It sets the communication protocol of PTZ device.

4. Address

It sets the communication address of PTZ device.

 **Notice:** Baudrate and protocol should be found in PTZ camera user manual.

PTZ CONTROL INTERFACE













Fig4.18 PTZ Control



Click  button in the Main Interface (referred Fig4.2 Main Interface) and enter the PTZ Control interface which is shown as Fig4.18 PTZ Control.

You can control PTZ devices by the function buttons on the right side of the interface. The function of the buttons is described as below table.

Icon	Description	Icon	Description
	Rightward Controlling the Speed Dome to swing right.		Leftward Controlling the speed dome to swing left.

Icon	Description	Icon	Description
	Upward Controlling the speed dome to swing up.		Downward Controlling the speed dome to swing down.
	FOCUS+ It sets the camera's long focus.		FOCUS- It sets the camera's short focus.
	ZOOM+ It sets the camera's zoom in.		ZOOM- It sets the camera's zoom out.
	IRIS+ It sets the PTZ device's much light.		IRIS- It sets the PTZ device's little light.
	Go to the Presetting Point		Set the Presetting Point
	Adjust PTZ speed It sets the rotational speed of the PTZ.		

CHAPTER 5 Operation with Mouse

5.1 Switch the Display of Channel

You can switch the display mode of channels in DVR with mouse.

- If the picture of the channel is in multi-divided mode, you could switch the picture to full screen through clicking on the picture.
- If the picture is in full screen mode, you could switch the picture to multi-divided mode through clicking on the picture.

5.2 Enter the Menu List

In live display mode, right-click on the picture to enter the menu list. There are three menus to choose: Search, Configuration and PTZ Control.

5.2.1 Search

Click "**Search**" menu to enter the Data menu (referred Fig3.36 Data) to select the submenu after entering the Menu list. Please refer '3.3.2 Search' to view the function of the submenu.

Right-click on the picture to exit the menu.

5.2.2 Configuration

Configuration submenu is used to display the Main Menu (referred Fig3.2 Main Menu).

Click "**Config**" menu to enter the Main Menu to select the submenu after entering the Menu List. Please refer '3.2 Main Menu Setting' to view the function of the submenu.

Right-click on the picture to exit the menu.

5.2.3 PTZ Control

Click "**PTZ Control**" menu to enter the PTZ mode. The shortcut menu of PTZ is shown as Fig5.1 Shortcut Menu of PTZ.

You could control the zoom-in and zoom-out, focus and input lightness of the Speed Dome.

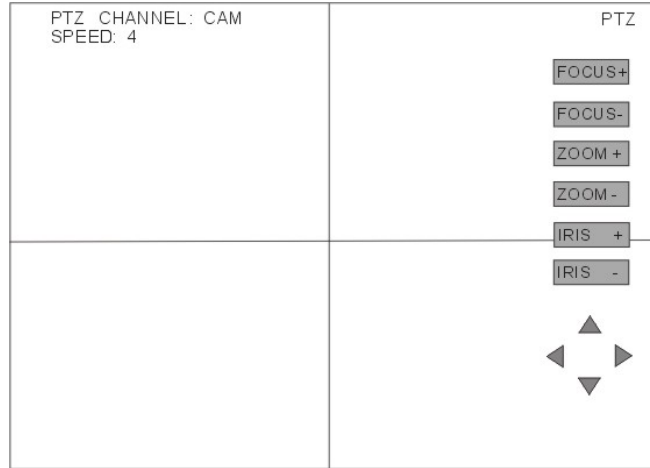

Fig5.1 Shortcut Menu of PTZ

FOCUS

Click "**FOCUS+**" button to control long focus of the Speed Dome. Click "**FOCUS-**" button to control short focus of the Speed Dome.

ZOOM

Click "**ZOOM+**" and "**ZOOM-**" buttons to control the Speed Dome zooming in and zooming out.

IRIS

Click "**IRIS+**" and "**IRIS-**" buttons to control little and much light of the Speed Dome.

 **Notice:** ▲, ◀, ▶ and ▼ buttons are used to control the Speed Dome to swing up, right, left and down.

5.3 Fast Reverse and Fast Forward

When you play back the record, you can backward or forward the record.

Multiple of reversing and forwarding is controlled through using the mouse. The shortcut menus of fast backward and fast forward are shown as Fig5.2 Fast Reverse and Fast Forward.

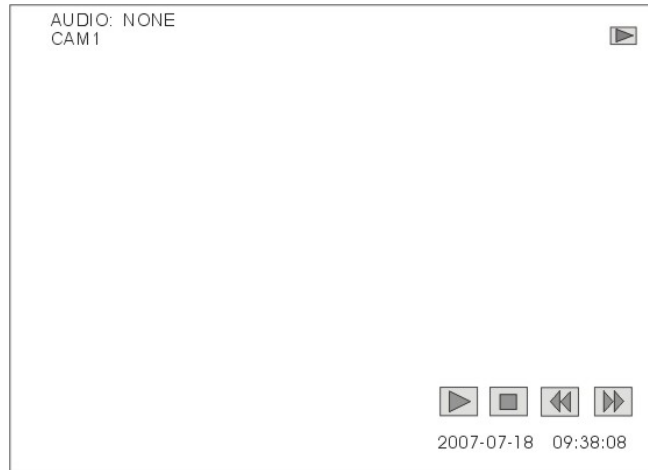





Fig5.2 Fast Reverse and Fast Forward

- Click  button to play back the record.
- Click  button to stop playing back.
- Click  button to fast reverse the record.
- Click  button to fast forward the record.

CHAPTER 6 Frequently Asked Questions

Question1: You have been download and install Network Client software from the DVR. But after inputting DVR IP, username and password, it appears ' Can't open codec TVTTH '.

Answer: When installing the software, the system regedit and system file need to be modified. And if you login the system as ordinary user, the modification operation could not be performed. So you need login the system as administrator when you install the Network Client software.

Question2: Why the backup speed with USB disk is so slow?

Answer: If you open the Network Client or playing back the record, the backup speed will be slow.

Appendix A Main Standard & Parameter

Model		4Channel	
VIDEO			
Input Level		4×BNC 1.0Vp-p±10%.75Ohm	
Video Standard		NTSC / PAL	
Video Output		2×BNC 1.0Vp-p±10%.75Ohm, 1×S-Video, 1×VGA(optional item)	
Screen Split Control		1, 4Screen	
Display	Resolution	NTSC	720x480
		PAL	704x576
	Speed	NTSC	120FPS
		PAL	100FPS
AUDIO			
Compression		PCM	
Audio In/ Out		2CH/ 1CH	
Input Level		TBD(0.5~1.4Vp-p@20Kohm)	
RECORDING			
Compression		H.264	
Compression bit rate		256kbps-512kbps	
Resolution	NTSC	352(H)x240(V)	
	PAL	352(H)x288(V)	
Speed	NTSC	Max 120FPS	
	PAL	Max 100FPS	
Mode		Manual, Schedule, Motion detection, Sensor	
Motion detection		16*12 detection areas can setup	
HDD interface		SATA × 1	
SEARCHING			
Searching Method		Time, Event	
REMOTE SURVEILLANCE			
Monitoring Environment		Client Software	

Digital Video Recorder User Manual

Real Time	App. 4CH Full Motion Transmission
ALARM	
Sensor Input	4Ports
Alarm Output	1-Out(Programmable), Terminal
Motion Detection	Available For Each Camera Multi Detection Level
CONNECTOR	
Video Input	BNC×4
Main Monitor Output	BNC×2(Parallel), S-Video×1, VGA×1(optional)
Audio Input (Mono)	RCA×2
Audio Output (Mono)	RCA×1
Sensor Input	Terminal Block
Alarm Output	Terminal Block
PTZ (RS-485)	2Pins Terminal Block
Ethernet	RJ-45, 10/100Mbps
USB 1.1	1Port
ELECTRICAL	
Power Source	12VDC
Power Consumption	TDP 21Watt
BACKUP	
Digital Backup	Network, USB 1.1
OTHERS	
OS	Embedded Linux operation system
Multiplex	Pentaplex
Control Device	Front Panel, Mouse, Remote Controller
PTZ	Panel, Mouse or internet

Appendix B Record Capability

The following table shows how much capability record of 4 channels engrosses per hour.

Picture Quality	PAL			NTSC		
	Resolution	Total frame rate	Capability (G/hour)	Resolution	Total frame rate	Capability(G/hour)
High	352*288	100F/S	908M	352*240	120F/S	915M
Medium	352*288	100F/S	670M	352*240	120F/S	690M
Low	352*288	100F/S	437M	352*240	120F/S	440M

 **Notice:** The data of the above table comes from our tests which are just used for user's reference. Different definition and stabilization (object's movement) of the images will lead different results.

Appendix C Abbreviation

Words	Meaning	Words	Meaning
L	Lock	HDD	Hard Disk
M	Motion Detection	A	Sensor Detection
L-L	The Login of Local	VLoss	Video Loss
PB	Playback and Backup	N-L	The Login in or Login out of the Network
O-D	Disk full of System Logs	L-C	Change Configuration of the DVR from the DVR
SYS	The Event of System Setting or the System Reset	N-C	Change the Configuration of the DVR from Network
DVR	Digital Video Recorder	DEL	Deletion Event

NOTE: The correct orientation for the enclosed power adapter is in a vertical or floor mount position.

Swann Technical Support

Worldwide Email support

tech@swann.com.au

UNITED STATES toll free

1-800-627-2799

1-877-274-3695

(Su, 2pm-10pm US PT)

(M-Th, 6am-10pm US PT)

(F 6am-2pm US PT)

USA Exchange & Repairs

562-777-2551

(M-F, 9am-5pm US PT)

AUSTRALIA toll free

1300 138 324

(M 9am-5pm AUS ET)

(Tu-F 1am-5pm AUS ET)

(Sa 1am-9am AUS ET)

New Zealand toll free

0800 479 266

International

+61 3 8412 4610

See <http://www.worldtimeserver.com> for information on different time zones and the time in Melbourne Australia compare to your local time.

Swann Communications Limited Warranty Terms and Conditions

Swann warrants this product against defects in workmanship and material for a period of one (1) year from it's original purchase date. You must present your receipt as proof of date of purchase for warranty validation. Any unit which proves defective during the stated period will be repaired without charge for parts or labour or replaced at the sole discretion of Swann. The repair or replacement will be warranted for either ninety days or the remainder of the original one year warranty period, whichever is longer. The end user is responsible for all freight charges incurred to send the product to Swann's repair centers. The end user is responsible for all shipping costs incurred when shipping from and to any country other than the country of origin. The warranty does not cover any incidental, accidental or consequential damages arising from the use of or the inability to use this product. Any costs associated with the fitting or removal of this product by a tradesman or other person or any other costs associated with its use are the responsibility of the end user. This warranty applies to the original purchaser of the product only and is not transferable to any third party.

Unauthorized end user or third party modifications to any component or evidence of misuse or abuse of the device will render all warranties void.



Swann Communications
2008©