

BURY Motion Universal



Index

Introductory information	2
1. General	2
2. Security guidelines	2
Installation of the hands-free car kit	4
3. Scope of supply	4
4. Installation of the system	6
5. Positioning and mounting	9
6. Installing the BURY Motion Universal in your vehicle	10
7. Inserting and removing the mobile phone	12
Operating guidelines	14
8. Rotating the BURY Motion Universal	14
9. Using the hands-free car kit for the first time	14
10. Establishing a <i>Bluetooth</i> connection	15
11. Action button features	16
12. Playing back music from your smartphone	17
13. Charging your smartphone	17
Further information	18
14. Service	18
15. Appropriate use of this system	19
16. Approvals and declaration of conformity	19

1. General

Dear customer,

Congratulations on purchasing a BURY hands-free car kit. You have chosen a high quality product that is extremely easy to use.

Please read the operating manual carefully so that you can fully enjoy your BURY hands-free car kit. If you have any further questions concerning installation or operation of your car kit, please contact your dealer. He will be happy to give you reliable advice.

You can also contact our hotline. Our phone and fax numbers are listed in the chapter Service at the end of the operating instructions.

Have a good trip!

2. Security guidelines

Installation - who and where

The installation of this system can be carried out by yourself but please observe the installation requirements of the automotive manufacturer (VAS 1978). During the installation, park the car at a place where the road traffic is not impaired.



Power supply

This system has been designed for the use in vehicles with an on-board supply system of 12 volts (passenger car). If you intend to install the device in a vehicle with an on-board supply system of 24 volts (lorry), please use a voltage converter. If you have queries regarding this subject, please contact our hotline.



Position, volume

Install the components of the device in the vehicle so that your field of vision is not impaired and the components are not mounted in the impact zone of the passenger compartment or in the airbag inflation zones.



Intended use

We shall not be liable for damages or malfunctions due to improper use of the hands-free system. Therefore, do not expose the device to moisture, extreme temperatures or shocks and carefully follow the procedure described in the installation and operating guidelines.



Use while driving

Operate the system only when the situation allows it and when you do not endanger, harm, constrain, or annoy other road users. The volume of the device has to be set in a way that exterior noise is still audible.

Faults

Do not commission the device if you detect or assume a defect. In this case, contact a Bury specialised dealer or our hotline. Improper repair efforts can be dangerous for you. Therefore, only skilled personnel may perform inspections.

Using the power supply cable with the cigarette lighter plug

Please only use this cable in connection with the BURY Motion Universal. Do not charge up a mobile phone or laptop using the cable. The cable is not suitable for use in HGVs. The voltage output that is emitted on the mini USB plug totals 12 volts.

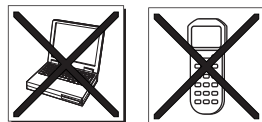

Important:

- ▶ The driver is ultimately responsible for the safe operation and control of their vehicle at all times. You should never use a hand held phone, including sending or reading text or picture messages, while driving.
- ▶ Research indicates that there is a risk to safety when the driver of a motor vehicle is distracted and using a mobile phone while driving can be a distraction.
- ▶ The manufacturer strongly recommends that you use a hands-free solution when driving.

3. Scope of supply

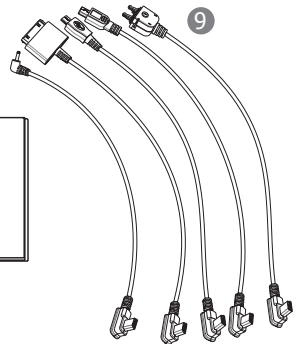
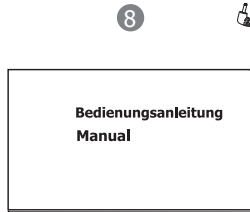
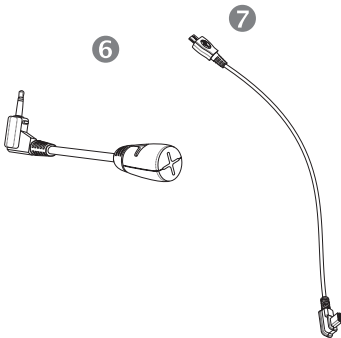
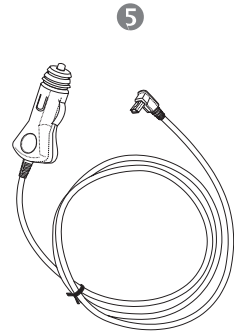
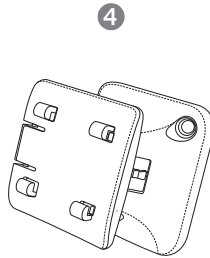
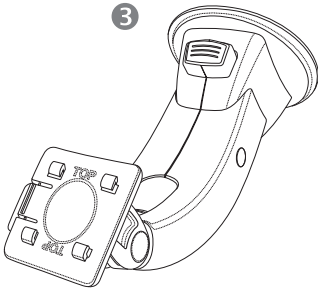
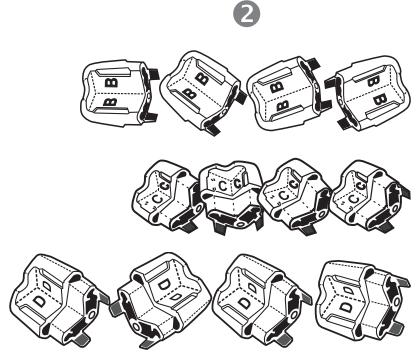
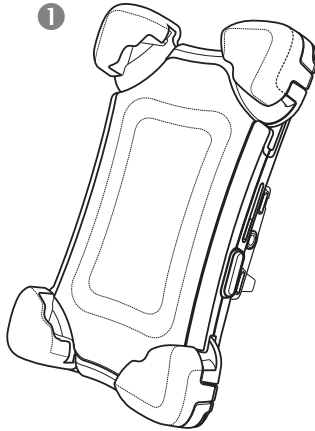

The hands-free car kit (HFCK) is supplied with different combinations of components, depending on the sales regions (countries). The operating manual refers to all versions.

Description of the components:

- 1) BURY Motion Universal (BMU) with integrated electronics
- 2) Set of tips for specific mobile phone models
- 3) Window Mount
- 4) Dash Mount Adapter for installation on the dashboard or console
- 5) 12V vehicle power adaptor cable with cigarette lighter connection
- 6) External microphone
- 7) Charging cable (Micro USB)
- 8) Quick user guide

Accessories - available separately / including, if applicable:

- 9) Mobile phone and Smartphone-specific charging cable

Note:

► If certain components are added or omitted you will receive the corresponding information on a separate enclosure.

Slots and buttons description:

1. Power supply 12V / updates
2. AUX OUT
3. Charger socket (5V)
4. Microphone socket
5. Potentiometer (volume adjustment)

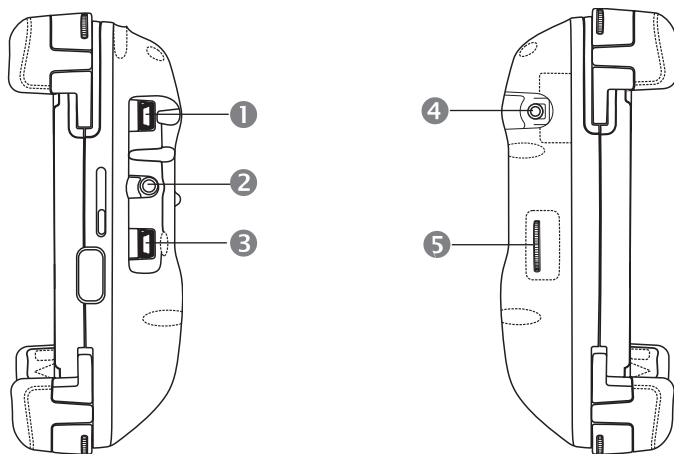

4. Installation of the system

Important:

- ▶ When positioning the device please take care that it does not impair the view onto the road, will not be installed in the impact zone of the passenger compartment (amongst others in the airbag inflation zones) and that the cable may be laid without any problems.
- ▶ Please avoid direct sunlight on the device or high internal temperatures, which can be rapidly reached in parked vehicles. In such cases, remove the device and put it in the car glove pocket or glove box for instance.

Step 1:

Adjusting corner fasteners to wide ranging models of mobile phone.

To be able to select the suitable type of corner fastener for a certain model of mobile phone / smartphone, please familiarize yourself with the corresponding compatibility list. This list is available on our internet site in the download area for the product at www.bury.com.

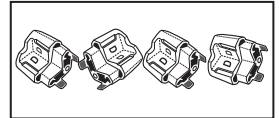

Important:

- ▶ Every corner fastener set is equipped with a letter notation which is positioned on the interior side of the corner fastener.

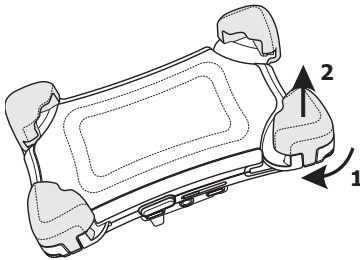
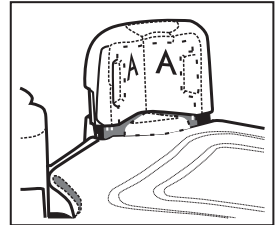

Corner fasteners adjustment:

1. Turn the corner fastener with the rotary knob (1) in a clockwise direction.
2. Detach the corner fastener in the direction of the arrow (2).
3. Fit the correct ending for the corner fastener and tighten it by turning it anticlockwise.
4. Repeat the above steps with the remaining three corner fasteners.

Step 2:**Adapting the BURY Motion Universal to the size of the mobile phone.****Important:**

► Before you begin to adjust the BMU to fit your particular mobile phone, it is important that you set the device to the closed position. This can be done by pushing the top of it until the locking button on the right side pops out with an audible “click”.

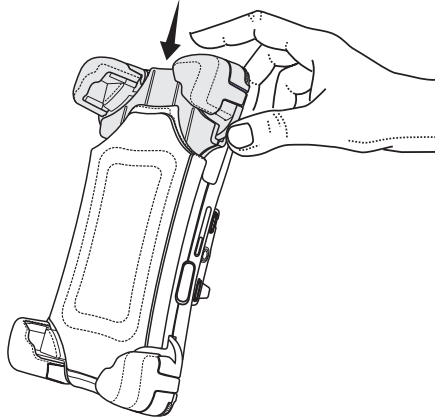

To be able to adapt the device to the size of the mobile phone lift all of the adjustment locks by pressing the release buttons **1**, **2**, **3** until they click.

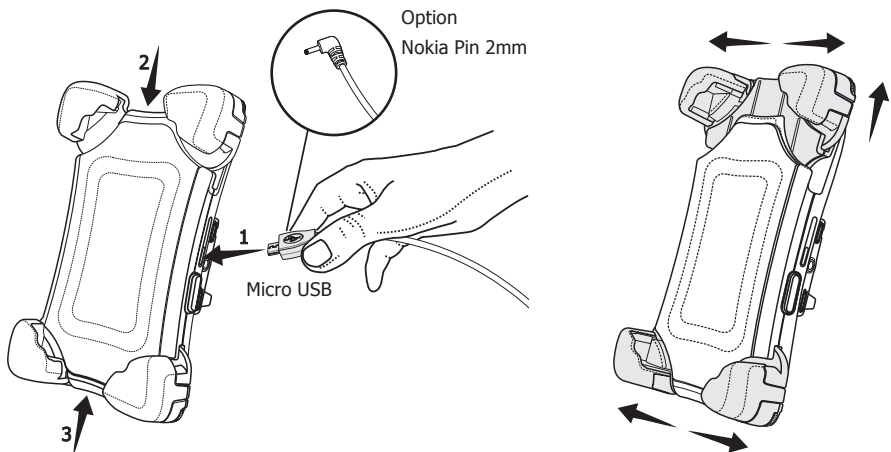

8 Installation of the hands-free car kit

Insert the mobile phone into the BURY Motion Universal.

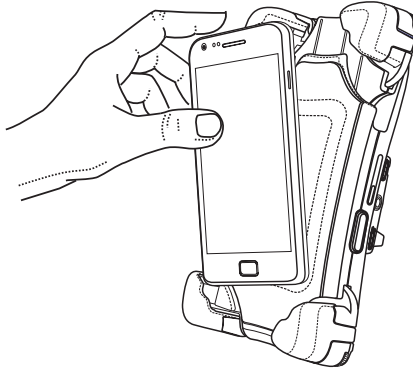

Firstly, adjust the lower width of the BMU to the width of the mobile phone and press button **1** in order to block the set position. Next adjust the height and the upper width of the device to the height and width of the phone and press in keys **2** and **3** in order to block the set positions.

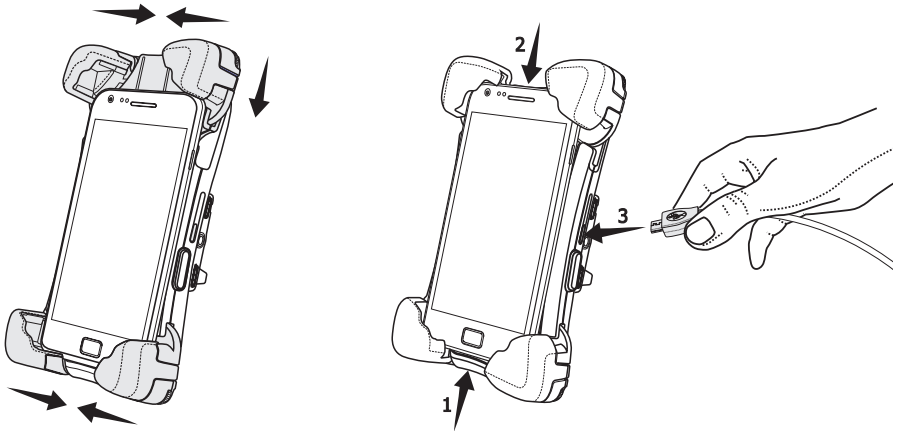

Please note:

► It is possible to set all positions of the BMU at the same time by lightly pressing button **1, 2 and 3**.

Step 3:
Adjusting the corner fastener.

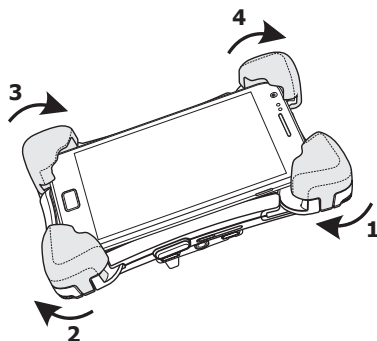

Adjust the corner fastener to the thickness of the phone – increase the depth by turning it in a clockwise direction, tighten it by turning it anticlockwise.

5. Positioning and mounting

First of all, please choose the most convenient position for the BURY Motion Universal in your vehicle by checking different positions in the vehicle. In the following chapters, the Window Mount serves as an installation example. The mounting of the Dash mount Adapter may be different, depending on the vehicle. In this context, it may be necessary to purchase additional tools such as a console or a mounting bracket separately through your specialist retailer.

If you would like to use the device during your journey, positioning it in the front area on the driver's side is advisable. Sit in the vehicle and check whether you can reach the device without difficulty.

After having found a suitable position for the BURY Motion Universal in the vehicle you can now mount the device. Please use a cleaning cloth for degreasing the surfaces to which you want to attach the Window Mount.

6. Installing the BURY Motion Universal in your vehicle

Step 1:

Connecting the BURY Motion Universal with the Window Mount

Push the BURY Motion Universal in the Window Mount until you can feel it click into place. After this, attach the Window Mount with the BURY Motion Universal in the vehicle.

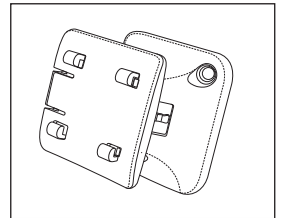
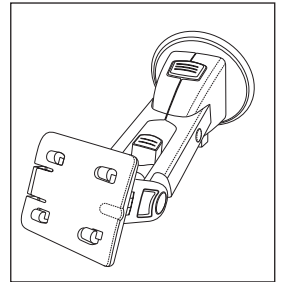
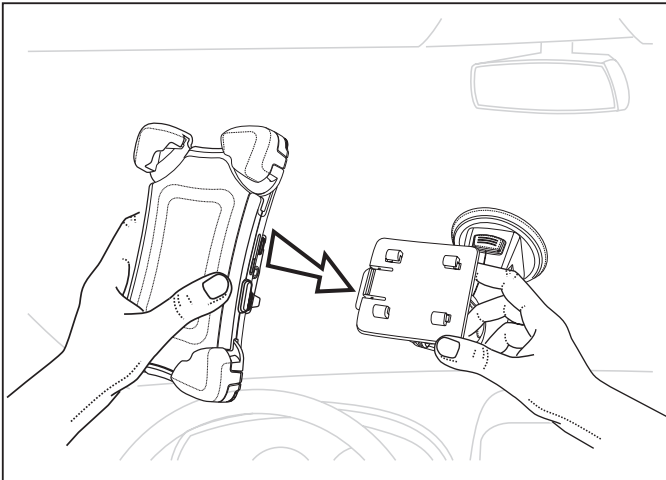

Note:

► You will find the same snap-in mechanism on the Window Mount as you do on the Dash Mount Adapter.

Step 2:

Attaching the BURY Motion Universal to the windscreen

Put the Window Mount on a smooth, dry, dust-free and oil free surface. The Window Mount remains attached to almost all smooth surfaces. The suction pad attachment is especially suitable for rapid and straight-forward attachment to the front windscreen. Please use a cleaning cloth to remove grease from the windscreen.

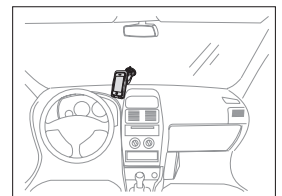

With the help of a suction pad you can attach the BURY Motion Universal to the windscreen. To do this, use the press-stud on the Window Mount in order to either increase or decrease the pressure on the suction pad. To do this, use the press-stud on the Window Mount in order to either increase or decrease the pressure on the suction pad. If you press down on the press stud from top to bottom then the suction pad attachment loosens again.

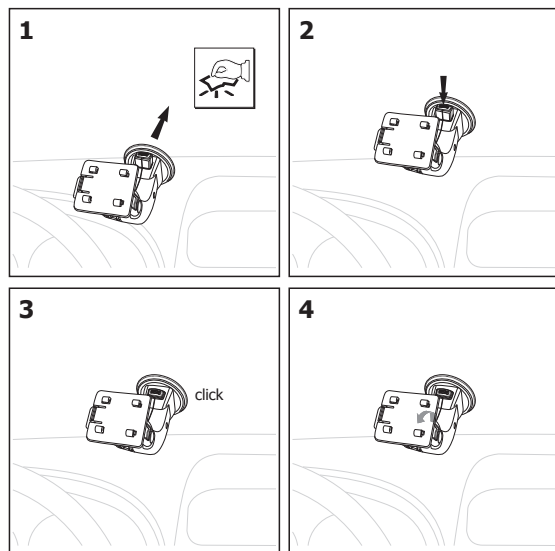

Step 3:

Attaching the plug-in external Microphone

Please connect the microphone to the microphone socket.

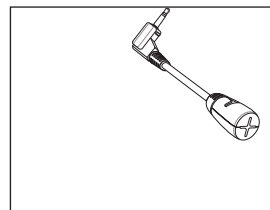

Step 4:

The power supply connection

Connect the car power cord to the cigarette lighter plug and its other end to the BURY Motion Universal.

Description of the power supply connection:

When using the ISO power supply cable, please comply with the instructions in the documentation about your vehicle and radio concerning the Pin allocations on the ISO-plugs. The Cinch plugs are for transferring the audio signals. It is possible that the radio in your vehicle has other inputs. The corresponding adapters are available through your specialist retailer.

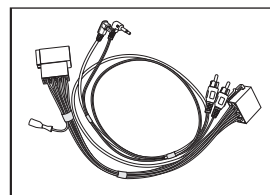

7. Inserting and removing the mobile phone

Insert the smartphone in the BURY Motion Universal.

Before you insert the smartphone in the BMU, release the holding mechanism by pressing the locking button in. The locking button is situated on the right hand side of the device.

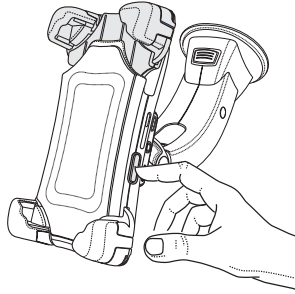

If necessary, remove the protective cover from your smartphone. Place the smartphone in the BMU from above.

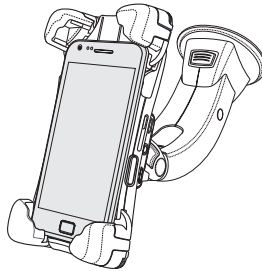

Press the top part of the device downwards and you will hear the smartphone click into the BMU. The correct positioning of the smartphone in the device is signalled by a perceptible 'clicking' sound.

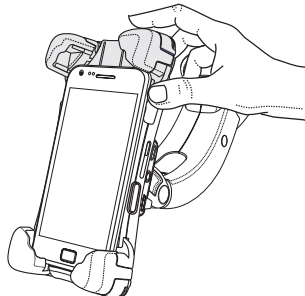

Removing the smartphone from the BURY Motion Universal.

To release the locking mechanism press the button on the right hand side of the device.

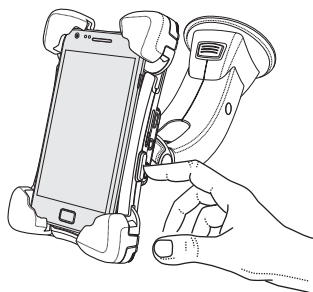

Now remove the smartphone by lifting it out of the BMU.

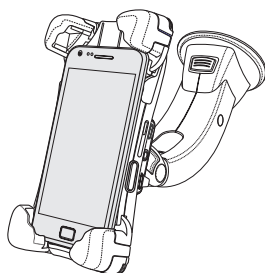

8. Rotating the BURY Motion Universal

You can turn the smartphone by 180 degrees (90 degrees to the left or right accordingly) together with the BMU. Rotate your device to best suite the application you are using. Used in the landscape (horizontal) format, most smartphones will adjust the text size and websites images automatically making them easier to read. Using the cradle to the landscape format also gives more space for the onscreen keyboard making it easier to enter text data.

Important Safety Notice:

► Entering text or viewing websites on your smartphone whilst driving is extremely dangerous and illegal in most countries. Always ensure your vehicle is stationary and safely parked before using your smartphone for these activities. Setting the BMU or phone screen format should be done before commencing your journey.

Navigation applications especially benefit from the landscape format view because all the operational elements of the software are positioned clearly. Due to the reduced horizon in the landscape format, the 3D map presentation will probably contain significantly more detailed information.



9. Using the hands-free car kit for the first time

After the power supply of the BURY Motion Universal hands free car kit (HFCK) is successfully connected, the HFCK is activated when you have started the vehicle.

After connecting the BMU to the power supply for the first time, press and hold the action button for about 5 seconds until you hear a sound, after which the device will offer the languages that are available for you to choose (English, German, French, and Spanish). Briefly press the function key to select the language that you have chosen. The characteristics of the remaining functions of the action button are described below. In order to restore factory settings press and hold the function button and plug-in the power supply simultaneously. Release it when you hear a sound indicating that the device was restarted and the language selection will start over.

10. Establishing a *Bluetooth* connection

If you wish to establish a *Bluetooth* connection between your mobile and the HFCK for the first time, you have to activate the *Bluetooth* function of your mobile phone and search for *Bluetooth* devices. In this case, search for a device labelled „BMU...“. If several devices were identified, please select the BMU and enter the **PIN number „1234“**. The *Bluetooth* connection (pairing) will then be established between your mobile phone and the HFCK. Next, press down on the ‚Pair‘ button in order to create the connection with the HFCK.

In addition it is possible that you must delete all devices connected to your mobile phone first in order to enable a correct identification of the HFCK and the establishment of a connection.

Note:

► If the rechargeable battery of the mobile phone is low, it is sometimes not possible to establish a *Bluetooth* connection.

The HFCK has a memory for the storage of the identification of up to 8 mobile phones. In case a ninth mobile phone is connected, the oldest entry in the HFCK memory will be cancelled.

The *Bluetooth* connection is interrupted if you deactivate the *Bluetooth* function on your mobile phone or you interrupt the supply of power to the BURY Motion Universal. In addition, the connection is disconnected, if you move too far away from the vehicle while taking your mobile phone with you and thus leave the reception radius of the HFCK.

Please note that the capacity of your mobile phone's storage battery can quickly decrease when the *Bluetooth* function is active. If you do not want to use the *Bluetooth* function anymore, e.g. if you leave the vehicle for a longer period, it is recommended to deactivate this function.

Note:

► This function is only available if the multipoint function has been activated.

Thanks to the **Multipoint** function, you can connect two mobile telephones simultaneously to BMU via *Bluetooth*. You can operate this function with the home button. The phone which is connected first gets priority, this means that only its phone books, call lists and voice tags are uploaded and can be retrieved from the HFCK memory.

This is the same situation as if only one mobile phone was connected to the HFCK. However, if the secondary mobile receives a call then this call is also taken via the HFCK.

When the BURY Motion Universal is switched on, the device connects with the mobile phone which was connected last. The prerequisite for this is that it is located in the vehicle, that the *Bluetooth* function is activated and the connection identification to the HFCK is not deleted.

If both mobile phones happen to receive a call at the same time then the primary phone will get priority. The incoming call on the other mobile will be displayed to you after the first call has been answered or rejected. Then the first call can be ended quickly and then the second can also be rejected (both of

these steps are taken by pressing the end button) or the first call can be ended and the second call answered (by pressing the call button).

It is not possible to put the first caller on hold because both callers did not phone the same number. Should another phone ring during the call then the incoming call can be rejected by pressing the end button on the phone.

Note:

► For some mobile combinations, in multipoint mode, it can be the case that the voice output during an active phone call is no longer emitted via the BMU if you accept an incoming call on the second phone using the phone itself.

► Completely functional call management can only be guaranteed by using the BMU control panels.

11. Functional action button features

On the back side of the BURY Motion Universal there is a function key (action button) that is designed to perform all major operations of the device. After connecting the BMU to the power supply for the first time, press and hold the action button for about 5 seconds until you hear a sound, after which the device will offer the languages that are available for you to choose (English, German, French, and Spanish). Briefly press the function key to select the language that you have chosen. The characteristics of the remaining functions of the action button are described below.

When the device is turned on but not connected to the phone:

- press the action button longer to enable or disable the multipoint function, which allows you to connect two mobile phones
- press the action button briefly to enable or disable the autoconnect feature of the paired phone (or two)

When the device is turned on and connected to one or two phones:

- press the function button longer to disconnect your phone(s) from the device
- press the function key briefly to activate the Voice Tag option of the phone (if included)

In the case of an incoming call:

- press the button briefly to receive an incoming call
- press the button longer to reject an incoming call

In the case of an active call (the conversation):

- press the action key shortly to end an active call (disconnects the caller)

Restore factory settings:

- press and hold the function button and plug-in the power supply simultaneously. Release it when you hear a sound indicating that the device was restarted and the language selection will start over

Functional Action Button

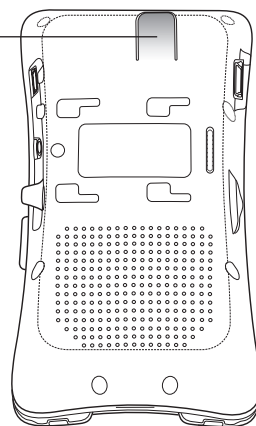

12. Playing back music from your smartphone

You can play back music files saved on your iPhone via the BURY Motion Universal, thanks to the integrated amplifier (class D) and the speaker. Sound can be transmitted in stereo quality through the AUX OUT output.

Thanks to the high resolution of the multi-touch screen, listening to music with the iPhone isn't just an acoustic experience, it's also a visual experience.

While listening to your music you can also control the volume level by using the potentiometer.

13. Charging your smartphone

After placing the smartphone in the BURY Motion Universal, it is being charged continuously by means of the charging cable, with which the smartphone is connected to the hands-free car kit device. It can not be disrupted the status of the Bluetooth connection between the smartphone and BURY Motion Universal.

Please note:

► On certain vehicles the cigarette lighter plug is supplied with electricity at all times. For this reason, always remove your smartphone from the cradle on leaving your vehicle. This also enables you to save your vehicle's battery.

14. Service

In case of general or technical queries, suggestions and comments, please do not hesitate to contact our team at any time. Suggestions and feedback are always welcomed:

Administration:

BURY GmbH & Co. KG
Robert-Koch-Straße 1-7
D-32584 Löhne
Germany

Producer:

BURY Spółka z o.o.
ul. Wojska Polskiego 4
39-300 Mielec
Poland

Hotline: +49(0)180 5 - 842 468*

Faxline: +49(0)180 5 - 842 329*

* 0.14 €/min. Deutsche Telekom AG landline,

the costs of international telephone calls which are made from abroad can vary.

E-Mail: hotline@bury.com

Warranty / Service desk:

The duration of the warranty for the components of this product totals two years subsequent to the date of sale to the end customer. Any warranty claims you may have as an end customer are to be asserted towards your contractual partner. If the corresponding contractual partner is not able to rectify a corresponding fault, please exercise your rights of purchase. If subsequent to agreement with your contractual partner the product is to be sent directly to the manufacturer, then please send it, along with a detailed description of the fault in the German or English language and a copy of the proof of purchase, directly to our service team:

BURY GmbH & Co. KG

Im Hause DPD Depot 103
Robinienweg
D-03222 Lübbenau
Germany

Specific explanations regarding the assertion of claims based on defects of the product (warranty / guarantee / service) for certain countries can be found at the end of these instructions.

Information on the disposal of electrical goods in the EU

The crossed out wheellie bin symbol means that electrical and electronic products, batteries and accumulators must be disposed of separately in the European Union. Please do not dispose of any such products in your normal household waste. As the owner of a product of this sort you are legally obliged to dispose of it at your local dumping site or recycling centre, where you are able to leave your waste electrical goods free of charge.

15. Appropriate use of this system

This hands-free car kit is only intended for use with *Bluetooth* mobile telephones and music playback systems in motor vehicles. When using this system, please comply with the regulations and laws specific to the country in which you are driving and the instructions provided in the guidebook for the mobile telephone that you are using.

16. Approvals and declaration of conformity

Purchase and production as well as service and sales at BURY are subject to tough quality and environmental management conditions according to ISO 9001 and ISO 14001. The device has



the CE approval pursuant to the R&TTE 1999/5/EC regulation



e1 type approval pursuant to the 72/245/EEC (2006/28/EC) regulation
Electro-magnetic compatibility in vehicles

You can request a conformity declaration from the manufacturer of this product by post under the manufacturer's address which is stated above, or by writing to the following email address: ce_conformance@bury.com. Please provide your email request in either English or German.

Version: 07/2012

25.1513.0-01-050412

Errors and omissions excepted.

The *Bluetooth*® word brand and the *Bluetooth*® logos are owned by Bluetooth SIG, Inc. All use of these brands by BURY Technologies takes place within the scope of the corresponding licence. All of the other stated brands are owned by their corresponding owner.

© 2010 by BURY. All rights reserved.