

FOR CAR USE ONLY/NUR FÜR AUTOMOBIL GEBRAUCH/POUR APPLICATION AUTOMOBILE UNIQUEMENT/PARA USO EN AUTOMÓVILES/SOLO PER L'UTILIZZO IN AUTOMOBILE/ENDAST FÖR BILBRUK/ALLEEN VOOR GEBRUIK IN DE AUTO/ТОЛЬКО ДЛЯ ИСПОЛЬЗОВАНИЯ В АВТОМОБИЛЯХ/DO UŻYCIA TYLKO W SAMOCHODZIE

# ALPINE®

EN

## iLX-700



Alpine Tunelt App

- **OWNER'S MANUAL**  
Please read before using this equipment.
- **BEDIENUNGSANLEITUNG**  
Lesen Sie diese Bedienungsanleitung bitte vor Gebrauch des Gerätes.
- **MODE D'EMPLOI**  
Veuillez lire avant d'utiliser cet appareil.
- **MANUAL DE OPERACIÓN**  
Léalo antes de utilizar este equipo.
- **ISTRUZIONI PER L'USO**  
Si prega di leggere prima di utilizzare il attrezzatura.
- **ANVÄNDARHANDLEDNING**  
Innan du använder utrustningen bör du läsa igenom denna användarhandledning.
- **GEBRUIKERSHANDLEIDING**  
Lees deze aanwijzingen aandachtig alvorens dit toestel te gebruiken.
- **РУКОВОДСТВО ПО ЭКСПЛУАТАЦИИ**  
Прочтите настоящее руководство перед началом использования оборудования.
- **INSTRUKCJA OBSŁUGI**  
Prosimy zapoznać się z tą instrukcją przed przystąpieniem do użytkowania urządzenia.

**ALPINE ELECTRONICS MARKETING, INC.**  
1-7, Yukigaya-Otsukamachi, Ota-ku,  
Tokyo 145-0067, JAPAN  
Phone: 03-5499-4531

**ALPINE ELECTRONICS OF AMERICA, INC.**  
19145 Gramercy Place, Torrance,  
California 90501, U.S.A.  
Phone 1-800-ALPINE-1 (1-800-257-4631)

**ALPINE ELECTRONICS OF AUSTRALIA PTY. LTD.**  
161-165 Princes Highway, Hallam  
Victoria 3803, Australia  
Phone 03-8787-1200

**ALPINE ELECTRONICS GmbH**  
Wilhelm-Wagenfeld-Str. 1-3, 80807 München, Germany  
Phone 089-32 42 640

**ALPINE ELECTRONICS OF U.K. LTD.**  
Alpine House  
Fletchamstead Highway, Coventry CV4 9TW, U.K.  
www.alpine.co.uk

**ALPINE ELECTRONICS FRANCE S.A.R.L.**  
(RCS PONTOISE B 338 101 280)  
98, Rue de la Belle Etoile, Z.I. Paris Nord II,  
B.P. 50016, 95945 Roissy Charles de Gaulle  
Cedex, France  
Phone +33-(0)1-48638989

**ALPINE ITALIA S.p.A.**  
Viale Cristoforo Colombo, 8  
20090 Trezzano sul Naviglio MI, Italy  
Phone +39 02 484781

**ALPINE ELECTRONICS DE ESPAÑA, S.A.**  
Portal de Gamarra 36, Pabellón, 32  
01013 Vitoria (Alava)-APDO 133, Spain  
Phone 945-283588



# Contents

## Operating Instructions

### WARNING

|                      |   |
|----------------------|---|
| <b>WARNING</b> ..... | 5 |
| <b>CAUTION</b> ..... | 5 |
| <b>NOTICE</b> .....  | 6 |
| <b>CAUTION</b> ..... | 6 |

### Features

|                           |   |
|---------------------------|---|
| About Apple CarPlay ..... | 7 |
| About Home Screen .....   | 7 |

### Getting Started

|  |    |
|--|----|
| Accessory List .....                     | 8  |
| Location of Controls .....               | 8  |
| Touch Operation .....                    | 8  |
| Turning Power On or Off .....            | 8  |
| Turning the System On .....              | 9  |
| Adjusting the Volume .....               | 9  |
| Muting Quickly .....                     | 9  |
| Operating an Item in a List .....        | 9  |
| Using Siri .....                         | 9  |
| About Hands-Free Phone .....             | 9  |
| Parking Assist Interrupt Function .....  | 10 |
| Access to Climate Mode .....             | 10 |
| Applying TuneIt .....                    | 10 |
| Adjusting the sound via the iPhone ..... | 10 |

### Radio

|   |    |
|---|----|
| Listening to the Radio .....            | 11 |
| Presetting Stations Manually .....      | 11 |
| Presetting Stations Automatically ..... | 11 |
| Tuning to Preset Stations .....         | 11 |

### RDS

|   |    |
|---|----|
| Turning AF (Alternative Frequencies)<br>On or Off ..... | 12 |
| Receiving Traffic Information .....                     | 12 |

|  |    |
|--|----|
| Receiving Traffic Information Manually ..... | 13 |
| PTY (Programme Type) Tuning .....            | 13 |
| Priority News .....                          | 13 |
| Displaying Radio Text .....                  | 13 |

### Apple CarPlay (Optional)

|                               |    |
|-------------------------------|----|
| Access to Apple CarPlay ..... | 13 |
|-------------------------------|----|

### Auxiliary Device (Optional)

|  |    |
|--|----|
| Operating Auxiliary Devices (Optional) .....                     | 14 |
| Operating the Mobile Digital TV Receiver<br>(DVB-T) .....        | 14 |
| Changing to the Mobile Digital TV Receiver<br>(DVB-T) Mode ..... | 14 |
| About the DVB-T operation screen .....                           | 15 |

### Camera Operation (Optional)

|   |    |
|---|----|
| Rear Camera Operation .....   | 15 |
| Displaying the rear view video while the car is<br>in reverse ..... | 15 |
| Display the Rear View Video Manually .....                          | 15 |
| Guide Display On/Off Setting .....                                  | 16 |
| Adjusting the Caution Display Location .....                        | 16 |
| Calling the Adjusted Values of the<br>Camera .....                  | 16 |
| About the Rear Camera Guide .....                                   | 16 |
| Other Camera Operation .....  | 18 |
| About the Adjustment of the Caution Display<br>Location .....       | 18 |
| About the Adjusted Value of Image<br>Quality .....                  | 18 |

### Setup

#### Audio Setup

|   |    |
|---|----|
| Audio Setup Operation .....                         | 18 |
| Adjusting Balance (Between Left and<br>Right) ..... | 19 |
| Adjusting Fader (Between Front and Rear) .....      | 19 |
| Setting the Bass Level .....                        | 19 |
| Setting the Treble Level .....                      | 19 |
| Setting the Subwoofer .....                         | 19 |
| Turning Subwoofer ON/OFF .....                      | 19 |
| Adjusting the Subwoofer Level .....                 | 19 |
| Setting the Subwoofer Phase .....                   | 19 |
| Setting the Bass Engine SQ .....                    | 19 |
| Turning the Bass Engine SQ ON/OFF .....             | 19 |

|   |    |
|---|----|
| Setting the Bass Engine SQ Type .....         | 20 |
| Adjusting the Bass Engine SQ Level .....      | 20 |
| Setting the Volume for Each Application ..... | 20 |
| Setting the MX (Media Xpander) .....          | 20 |
| Equalizer Presets (EQ Presets) .....          | 20 |
| Setting Defeat .....                          | 20 |

## Display Setup

|  |    |
|--|----|
| Display Setup Operation .....                            | 21 |
| Switching Display Modes .....                            | 21 |
| Adjusting Brightness .....                               | 21 |
| Adjusting Color of Picture .....                         | 21 |
| Adjusting Image Contrast .....                           | 21 |
| Adjusting Picture Quality .....                          | 22 |
| Saving and Calling the Adjusted Picture<br>Quality ..... | 22 |

## General Setup

|   |    |
|---|----|
| General Setup Operation .....                       | 22 |
| Time Setting .....                                  | 23 |
| Setting the Clock Display .....                     | 23 |
| Setting the Time .....                              | 23 |
| Language Setting .....                              | 23 |
| Setting the Menu Language .....                     | 23 |
| Text Scroll Setting .....                           | 23 |
| Setting the Scroll .....                            | 23 |
| Key Sound Setting .....                             | 23 |
| Touch Sound Feedback On/Off setting .....           | 23 |
| Adjusting the Operating Sound .....                 | 23 |
| Setting Mute when Reversing .....                   | 23 |
| Screen/Lighting Setting .....                       | 23 |
| Setting the Brightness of the<br>Backlighting ..... | 23 |
| Button Backlighting Adjustment .....                | 24 |
| Display Backlighting Adjustment .....               | 24 |
| Changing the Opening Image .....                    | 24 |
| Security Code Setting .....                         | 24 |
| Setting Security code .....                         | 24 |
| Vehicle function Setting .....                      | 25 |
| Setting the Climate screen interrupt time ....      | 25 |
| Setting the Parking sensor interrupt time ....      | 25 |
| Setting the Vehicle type .....                      | 25 |
| About iLX-700 .....                                 | 25 |
| Displaying the Product Information .....            | 25 |
| Initializing the System .....                       | 25 |
| Demonstration Setup .....                           | 25 |
| Canceling the Demonstration .....                   | 25 |

## Application Setup

|   |    |
|---|----|
| Application Setup Operation .....                               | 26 |
| Camera Setting .....  | 26 |
| Setting the Camera Input .....                                  | 26 |
| Setting the Camera Signal Input .....                           | 26 |
| Adjusting the Rear Camera Guide .....                           | 26 |
| Setting the Camera Interrupt .....                              | 27 |
| Auxiliary Setting .....   | 27 |
| Setting the AUX Mode .....                                      | 27 |
| Apple CarPlay Setting .....                                     | 27 |
| Steering wheel Setting .....                                    | 27 |
| Setting the Siri Microphone Effect .....                        | 27 |
| Selecting the Output Speaker .....                              | 27 |
| Adjusting the Microphone Level .....                            | 27 |
| Radio Setting .....   | 28 |
| PI SEEK Setting .....   | 28 |
| Receiving RDS Regional (Local)<br>Stations .....                | 28 |
| Switching the Display Language of PTY<br>(Programme Type) ..... | 28 |
| Setting PTY31 (Emergency Broadcast)<br>Reception .....          | 28 |
| Setting the TUNER (FM) Tone Quality<br>(Tuner Condition) .....  | 28 |

## Information

|                               |    |
|-------------------------------|----|
| Product Software Update ..... | 29 |
| In Case of Difficulty .....   | 29 |
| If this Message Appears ..... | 29 |
| Specifications .....          | 30 |

# Installation and Connections

|  |           |
|--|-----------|
| <b>Warning</b> .....                       | <b>31</b> |
| <b>Caution</b> .....                       | <b>31</b> |
| <b>Precautions</b> .....                   | <b>31</b> |
| Installation .....                         | 32        |
| Uninstalling the original car stereo ..... | 32        |
| Mounting the Microphone .....              | 32        |
| Installing the Unit .....                  | 32        |
| Fix the Cables etc. ....                   | 32        |
| Connections .....                          | 34        |
| System Example .....                       | 36        |

---

---

# Operating Instructions

## WARNING



**This symbol means important instructions. Failure to heed them can result in serious injury or death.**

---

### **INSTALL THE PRODUCT CORRECTLY SO THAT THE DRIVER CANNOT WATCH TV/VIDEO UNLESS THE VEHICLE IS STOPPED AND THE EMERGENCY BRAKE IS APPLIED.**

It is dangerous for the driver to watch TV/Video while driving a vehicle. Installing this product incorrectly enables the driver to watch TV/Video while driving. This may cause a distraction, preventing the driver from looking ahead, thus causing an accident. The driver or other people could be severely injured.

---

### **DO NOT WATCH VIDEO WHILE DRIVING.**

Watching the video may distract the driver from looking ahead of the vehicle and cause an accident.

---

### **DO NOT OPERATE ANY FUNCTION THAT TAKES YOUR ATTENTION AWAY FROM SAFELY DRIVING YOUR VEHICLE.**

Any function that requires your prolonged attention should only be performed after coming to a complete stop. Always stop the vehicle in a safe location before performing these functions. Failure to do so may result in an accident.

---

### **KEEP THE VOLUME AT A LEVEL WHERE YOU CAN STILL HEAR OUTSIDE NOISES WHILE DRIVING.**

Excessive volume levels that obscure sounds such as emergency vehicle sirens or road warning signals (train crossings, etc.) can be dangerous and may result in an accident. LISTENING AT LOUD VOLUME LEVELS IN A CAR MAY ALSO CAUSE HEARING DAMAGE.

---

### **MINIMIZE DISPLAY VIEWING WHILE DRIVING.**

Viewing the display may distract the driver from looking ahead of the vehicle and cause an accident.

---

### **DO NOT DISASSEMBLE OR ALTER.**

Doing so may result in an accident, fire or electric shock.

---

### **USE ONLY IN CARS WITH A 12 VOLT NEGATIVE GROUND.**

(Check with your dealer if you are not sure.) Failure to do so may result in fire, etc.

---

### **KEEP SMALL OBJECTS SUCH AS SCREWS OUT OF THE REACH OF CHILDREN.**

Swallowing them may result in serious injury. If swallowed, consult a physician immediately.

---

### **USE THE CORRECT AMPERE RATING WHEN REPLACING FUSES.**

Failure to do so may result in fire or electric shock.

---

### **DO NOT BLOCK VENTS OR RADIATOR PANELS.**

Doing so may cause heat to build up inside and may result in fire.

---

### **USE THIS PRODUCT FOR MOBILE 12V APPLICATIONS.**

Use for other than its designed application may result in fire, electric shock or other injury.

---

### **DO NOT PLACE HANDS, FINGERS OR FOREIGN OBJECTS IN INSERTION SLOTS OR GAPS.**

Doing so may result in personal injury or damage to the product.



**This symbol means important instructions. Failure to heed them can result in injury or material property damage.**

---

### **HALT USE IMMEDIATELY IF A PROBLEM APPEARS.**

Failure to do so may cause personal injury or damage to the product. Return it to your authorized Alpine dealer or the nearest Alpine Service Centre for repairing.

## NOTICE

### Product Cleaning

Use a soft dry cloth for periodic cleaning of the product. For more severe stains, please dampen the cloth with water only. Anything else has the chance of dissolving the paint or damaging the plastic.

### Temperature

Be sure the temperature inside the vehicle is between +60°C (+140°F) and -20°C (-4°F) before turning your unit on.

### Maintenance

If you have problems, do not attempt to repair the unit yourself. Return it to your Alpine dealer or the nearest Alpine Service Station for servicing.

### Installation Location

Make sure the iLX-700 will not be installed in a location subjected to:

- Direct sun and heat
- High humidity and water
- Excessive dust
- Excessive vibrations

Operation of some of the functions of this unit is very complex. Because of this, it was deemed necessary to place these functions into a special screen. This will restrict operation of these functions to times when the vehicle is parked. This ensures the focus of the driver's attention will be on the road and not on the iLX-700. This has been done for the safety of the driver and passengers. Some setup operations cannot be made if the car is moving. The car must be parked and the parking brake must be engaged for the procedure described in the Owner's Manual to be valid. The warning "Unable to operate while driving." will be displayed if any attempts are made to perform these operations while driving.

- *The iLX-700 draws minimal current even when its power switch is turned off. If the switched power (ignition) lead of the iLX-700 is connected directly to the positive (+) post of the vehicle's battery, the battery may be discharged. An SPST (Single-Pole, Single-Throw) switch (sold separately) can be added to simplify this procedure. Then, you can simply place it in the OFF position when you leave the vehicle. Turn the SPST switch back ON before using the iLX-700. For connecting the SPST switch, refer to the "Connection Diagram of SPST Switch (sold separately)" (page 33). If the power (ignition) lead is unswitched, it must be disconnected from the battery post should the vehicle be left unused for an extended period of time.*

### Protecting the USB connector

- Only an iPhone 5 or later or USB memory device can be connected to the USB connector on this unit. Correct performance using other USB products cannot be guaranteed.
- If the USB connector is used, be sure to use only the supplied connector cable with the unit. A USB hub is not supported.
- USB memory device is used for data file transfer or updates only.
- This unit does not support USB memory's Audio/Video playback or photo browse.

## CAUTION

*Alpine accepts no responsibility for lost data, etc., even if data, etc., is lost while using this product.*

- *iPhone, iTunes and CarPlay are trademarks of Apple Inc., registered in the U.S. and other countries.*
- *"Made for iPhone," means that an electronic accessory has been designed to connect specifically to iPhone, respectively, and has been certified by the developer to meet Apple performance standards. Apple is not responsible for the operation of this device or its compliance with safety and regulatory standards. Please note that the use of this accessory with iPhone may affect wireless performance.*

# Features

## About Apple CarPlay

Apple CarPlay allows your iPhone 5 or later to operate smoothly from this head unit.

## About Home Screen

The Home Screen for this unit gives direct access to those applications designed to work with Apple CarPlay. The Apple CarPlay icon will indicate whether the appropriate iPhone is connected.

### ■ When iPhone is connected



### ■ When iPhone is not connected



# Getting Started

## Accessory List

- iLX-700.....1
- Power cable.....1
- Flush head screw (M5x8).....4
- Screw (M5x8).....4
- AUX/CAMERA/CAN cable .....1
- USB extension cable .....1
- Microphone.....1
- Face plate.....1
- Owner's Manual ..... 1set

## Location of Controls

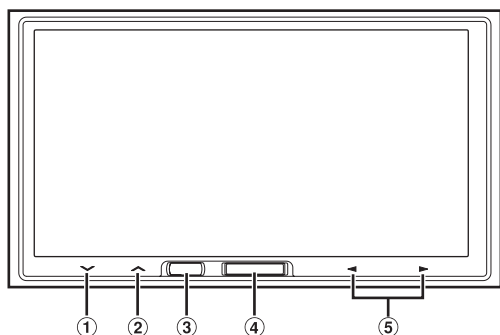

- ① **∨ button**  
Touch to turn down the volume. Touch and hold for at least 2 seconds to mute.
- ② **∧ button**  
Touch to turn up the volume.
- ③ **Siri button**  
Starts the Siri function of the iPhone.
- ④ **Home button**  
Press to call up the Home Screen.  
Press and hold for at least 5 seconds to turn the power off.
- ⑤ **◀▶ button**  
This action varies according to the Audio/Visual application.  
(Track Up/Down, Fast reverse/Fast forward, etc.)
  - You can reset the unit by pressing and holding Home and Siri buttons at the same time for 10 seconds.

### Connectable to Remote Control Interface Box

With an optional Alpine Steering Wheel Remote Control Interface Box (not included), this unit is controllable from the vehicles steering wheel controls. For details, contact your Alpine dealer.

### About the button descriptions used in this Owner's Manual

The buttons found on the face of the unit are expressed in bold (e.g. **Home**). The buttons found on the touch-screen display are shown in bold within brackets, [ ] (e.g. [**X**]).

## Touch Operation

Many of the operations for this unit are accessible through a light touch on the integrated touch panel.

- Be sure to touch the onscreen button lightly with the pad of your finger to protect the display.
- If you touch a button and there is no reaction, remove your finger from the display once, and try again.
- Onscreen buttons that cannot be operated appear dull in color.

### Common onscreen buttons

- [<]: Returns to the previous screen. Depending on the function, this button may cancel the operations performed on the screen.
- [X]: Closes the window.



## Turning Power On or Off

Some of this unit's functions cannot be performed while the vehicle is in motion. Be sure to stop your vehicle in a safe location and apply the parking brake, before attempting these operations.

- 1 Turn the ignition key to the ACC or ON position.**  
The system turns on.
- 2 Press and hold the Home button for at least 5 seconds to turn the power off.**

- The unit can be turned on by pressing Home button or Siri button.
- The iLX-700 is a precision device. Careful handling of the unit should provide you with years of trouble-free operation.



## Turning the System On

With the Alpine system, when the ignition key is turned to ACC or ON, the opening screen will be automatically displayed.

- 1 **When the system is used for the first time, the language selection menu is displayed. There are 20 languages to choose from. Touch the screen and sliding your finger up and down, and then touch the desired language.**

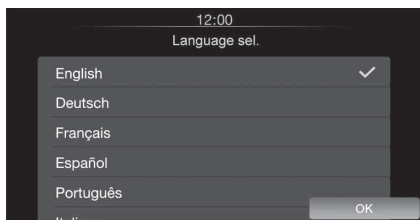

- 2 **Touch [OK].**  
The radio screen is displayed.

- When you turn on this unit first time, the demo mode starts automatically, and the demonstration screens are displayed one after another. To turn off Demo mode, refer to "Demonstration Setup" (page 25).
- Some of this unit's functions cannot be performed while the vehicle is in motion. Be sure to stop your vehicle in a safe location and apply the parking brake before attempting these operations.

## Adjusting the Volume

**Adjust the volume by touching  $\nabla$  or  $\blacktriangle$ .**  
Volume increases continuously by touching and holding  $\blacktriangle$ .  
Volume: 0 - 35

## Muting Quickly

Audio Mute function instantly lowers the volume level to 0.

**Touch and hold  $\nabla$  for at least 2 seconds to activate the mute mode.**

The audio level will be 0.

## Operating an Item in a List

- 1 **To scroll through a list, touch the screen and slide your finger up or down.**

The screen will scroll along with your finger movement.

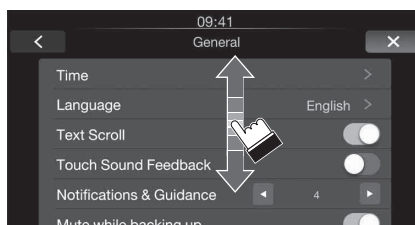

- To make a selection, touch the screen at the desired item, then lift your finger without moving the screen up or down.

- 2 **Touch the button and slide your finger right or left to change ON/OFF.**

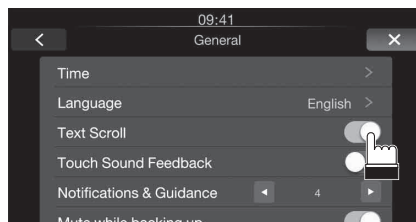

## Using Siri

You can use the Siri function of your iPhone. To use Siri from this unit, make sure that this function is Enabled in your iPhone settings.

**Press Siri.**

## About Hands-Free Phone

When connected to this unit, your iPhone can be used as hands-free. Incoming calls are displayed with the caller's ID when available.

- About iPhone models usable with this unit, refer to Apple CarPlay section (page 13).
- You can adjust the volume of the phone or select the speakers to be used for the call's audio. Refer to "Apple CarPlay Setting" (page 27).
- Avoid hands-free calls in heavy traffic or on narrow or winding roads. Keep your focus on driving to prevent an accident.
- Close the windows while calling to reduce background noise.
- When using a microphone, speak as directly as you can into the microphone to obtain the best sound quality.

## Parking Assist Interrupt Function

When the unit is connected to the vehicle equipped CAN Interface box. A Parking Assist screen may be tuned in if the obstacle within a certain distance is detected by the front or rear sensor of your vehicle. You can adjust the interrupt time for Parking Assist screen by “Setting the Parking sensor interrupt time” on page 25.

- Depending on your vehicle, this function may not be supported.

**When the obstacle within a certain distance is detected by the front or rear sensor, the Parking Assist screen displays and the indicator (①~⑧) of the corresponding area lights up.**

According to the distance from far to near, the colour of indicator from yellow to orange to red.

### ■ Display example for Parking Assist screen

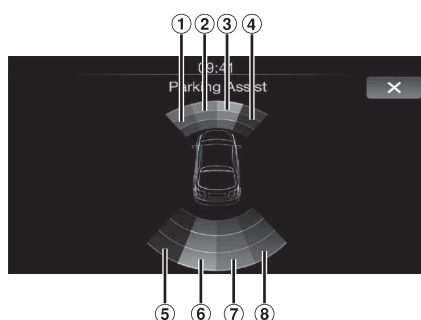

- You can also activate the Parking Assist screen by touch the Parking Assist icon on the Home screen.

## Access to Climate Mode

When the unit is connected to the vehicle equipped CAN Interface box, you can check the vehicle's air conditioning. You can adjust the interrupt time for Climate screen by “Setting the Climate screen interrupt time” on page 25.

**The Climate screen will be tuned in if you adjust the air condition in your vehicle.**

The Climate mode screen is displayed. You can check the information of your vehicle's air condition from the screen.

### ■ Display example for Climate screen

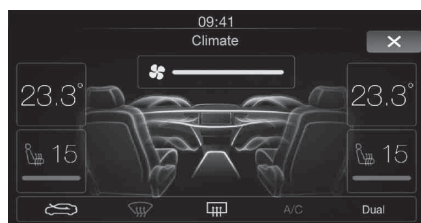

- Depending on the car type, some functions may not be available even though the CAN Interface box is connected.
- You can also activate the Climate screen by touch the Climate icon on the Home screen.

## Applying Tunelt

This unit's sound tuning is programmable from a connected iPhone. It is also possible to download specific parameters for certain vehicles from Alpine's Tunelt database stored in the Cloud. Using the Tunelt App, customized parameters can also be uploaded for others to share and rate. The installed Tunelt App should be launched on the iPhone before connecting to the head unit.

Tunelt, is downloadable from Apple's App Store. For details, consult your Alpine dealer.

- The application programme and related specifications and data may be deleted or terminated without notice.
- About iPhone models usable with this unit, refer to Apple CarPlay section (page 13).

### Adjusting the sound via the iPhone

After completing the procedure above, your iPhone can be used to make audio adjustments for this unit.

- 1 Make sure the unit is powered on.**
- 2 Launch the Tunelt App on the iPhone. Adjust the unit's sound accordingly on the iPhone.**

- Volume level cannot be adjusted via the iPhone.
- The setting cannot be done on both the iPhone and this unit at the same time.
- When the unit is powered off, etc., sound setting cannot be done via the iPhone.
- Please obey all local traffic laws while using this function.

# Radio

## ■ Display example for Radio main screen

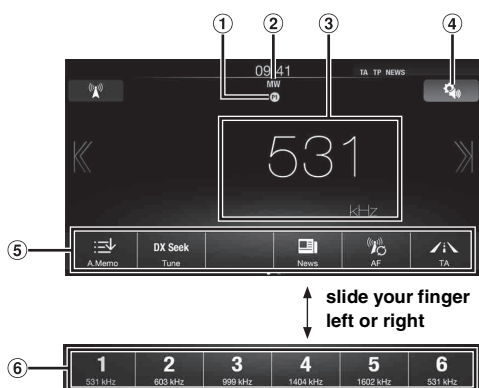

- ① Preset No. indicator display
- ② Band display
- ③ Frequency display
- ④ Audio Setup button (See “Audio Setup Operation” on page 18)
- ⑤ Function key
- ⑥ Preset button

## Listening to the Radio

- 1 Press the Home button.**  
The Home screen is displayed.
- 2 Touch [Radio].**  
The radio mode is activated and the display changes to the Radio mode screen.
- 3 Touch [📶] to select the desired radio band.**  
Each touch changes the bands as follows:  
FM-1 → FM-2 → FM-3 → MW → LW → FM-1
- 4 Touch [Tune] to select the tuning mode.**  
DX Seek      Local Seek      Manual  
⏪ ⏩      ⏪ ⏩      ⏪ ⏩
  - There are two modes you can select for auto tuning, DX and Local:
    - DX (Distance) mode;  
Both strong and weak stations will be tuned in.
    - Local mode;  
Only strong stations will be tuned in.  
The initial setting is DX.
  - If “Preset” or “PTY” appears touch [Tune] repeatedly until a tuning mode is displayed.
- 5 Touch [⏪], [⏩] or [⏪], [⏩] to change the radio frequency up or down respectively.**  
In manual mode, touch and hold to change the frequency continuously.

## Presetting Stations Manually

- 1 Tune in a desired radio station you wish to store in the preset memory by manual or automatic seek tuning.**
- 2 Touch and hold any one of the preset buttons for at least 2 seconds.**  
The selected station is stored.
- 3 Repeat the procedure to store up to 5 other stations onto the same band.**  
To use this procedure for other bands, simply select the desired band and repeat the procedure.  
A total of 30 stations can be stored in the preset memory (6 stations for each band; FM1, FM2, FM3, MW or LW).
  - If a preset memory has already been set in the same preset number, it will be cleared and the new station will be memorised.

## Presetting Stations Automatically

The tuner can automatically seek and store 6 strong stations in the selected band in order of signal strength.

**After selecting the desired band, touch and hold [A.Memo] for at least 2 seconds.**

The tuner automatically seeks and stores 6 strong stations into the preset buttons in order of signal strength. When automatic storing has completed, the station stored in the preset 1 is selected.

- If no stations are stored, the tuner will return to the original station you were listening to before the automatic storing procedure began.
- You can cancel this process by touching [A.Memo] while the tuner is automatically seeking stations. Cancelling will return the tuner preset to the previous setting.

## Tuning to Preset Stations

Select the desired preset in any band to tune to the station stored in that preset number.

- 1 Touch [📶] repeatedly until the desired band is displayed.**
- 2 Touch any one of the preset buttons that has a station stored to it.**  
The preset station is received.
  - You can also switch the preset station by touching [⏪] or [⏩] when the tuning mode of “Preset” is chosen.

# RDS

## ■ Display example for RDS Information

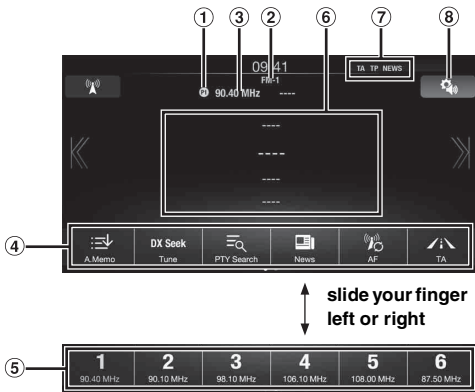

- ① Preset No. indicator display
- ② Band display
- ③ Frequency display
- ④ Function key
- ⑤ Preset button
- ⑥ Info area
- ⑦ RDS indicator
- ⑧ Audio Setup button (See "Audio Setup Operation" on page 18)

## Turning AF (Alternative Frequencies) On or Off

The RDS (Radio Data System) is a radio information system using the 57 kHz subcarrier of regular FM broadcasts. The RDS allows you to receive a variety of information such as traffic information, station names, and to automatically re-tune to a stronger transmitter that is broadcasting the same programme.

### 1 Press the **Home** button.

### 2 Touch **[Radio]**.

The radio mode is activated and the display changes to the Radio mode screen.

- The display content varies depending on the last band selected. (eg. [RadioFM1], etc.)

### 3 Touch **[AF]** of Bottom banner to select the AF (Alternative Frequency) ON or OFF mode.

In AF ON mode, the "AF" Indicator lights up.

- RDS mode is not be displayed for the MW or LW band.
- When the AF ON mode is selected, the unit automatically tunes to a strong signal station in the AF list.
- Use the AF OFF mode when automatic re-tuning is not required.

### Tips

- If the unit receives the PTY31 (Emergency Broadcast) signal, the unit will show "Alarm" in the display only when PTY31 is set to On. For operation, refer to "Setting PTY31 (Emergency Broadcast) Reception" (page 28).
- The RDS digital data includes the following:
 

|     |                                 |
|-----|---------------------------------|
| PI  | Programme Identification        |
| PS  | Programme Service Name          |
| AF  | List of Alternative Frequencies |
| TP  | Traffic Programme               |
| TA  | Traffic Announcement            |
| PTY | Programme Type                  |
| EON | Enhanced Other Networks         |
- Refer to page 28 about "PI SEEK Setting", "Receiving RDS Regional (Local) Stations", "Switching the Display Language of PTY (Programme Type)" and "Setting PTY31 (Emergency Broadcast) Reception".

## Receiving Traffic Information

### Touch **[TA]** to turn on the Traffic Information mode.

The TA indicator lights up.

When the traffic information station is tuned in, the TP indicator lights up.

Traffic information is heard only when it is being broadcast. If traffic information is not being broadcast, the unit is set in the standby mode.

When a traffic information broadcast begins, the unit automatically receives it and the display shows "T.Info".

When the traffic information broadcast is over, the unit will automatically be set to the standby mode.

- If the traffic information broadcast signal falls below a certain level, the unit remains in the receiving mode for 1 minute. If the signal remains below a certain level for over 70 seconds, "TA" will blink in the display.
- If you do not want to listen to traffic information being received, touch **[TA]** to skip that traffic information message. The T. Info mode will remain in the ON position to receive the next traffic information message.
- If the volume level is changed while receiving traffic information, the changed volume level will be memorised. When traffic information is received next time, the volume level will be automatically adjusted to the level memorised.
- If the Traffic Information mode is activated, the unit automatically switches to radio source (even if you select another source except navigation) and receives the traffic information broadcast. When the traffic information is finished, the unit returns to the previous source.

## Receiving Traffic Information Manually

- 1 **Touch [TA] to turn on the Traffic Information mode.**  
The TA indicator lights up.
  - 2 **Touch [◀] or [▶].**  
Seeks the broadcast station which is broadcasting the traffic information.
- You can seek the traffic information in DX Seek mode or Local Seek mode.

## PTY (Programme Type) Tuning

- 1 **Touch [PTY Search].**  
The Select PTY list screen is displayed.
- 2 **Touch the selected programme type to start searching for a station of that type.**  
If no PTY station is found, "No PTY." will be displayed.
- 3 **Touch [Tune] to choose the PTY tuning mode.**  
The PTY mode is activated.
- 4 **To select the station in PTY, touch [◀] or [▶].**

## Priority News

This function gives priority to the News programme. Whenever the News programme broadcasts, it will interrupt the programme you are currently listening to.

**Touch [News] to activate the PRIORITY NEWS mode.**  
The "NEWS" indicator appears in the display. Touch [News] again to deactivate the Priority News mode and return to the programme you were previously listening to.

## Displaying Radio Text

Text messages from a radio station can be displayed.

- 1 **Tune in a radio station that transmits text messages.**
- 2 **Touch the Info area (Ⓢ) (page 12) in FM radio mode repeatedly to switch to the desired display.**

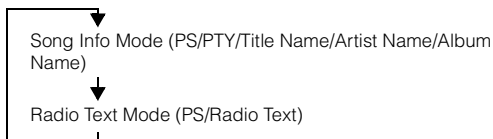

## Apple CarPlay (Optional)

Apple CarPlay is a smarter, safer way to use your iPhone in the car. Apple CarPlay takes the things you want to do with your iPhone while driving and puts them right on iLX-700. You can get directions, make calls, send and receive messages, and listen to music, all in a way that allows you to stay focused on the road. Just plug in your iPhone to iLX-700 and go.

- Before using this function, plug in your iPhone using Lightning to USB Cable (Supplied with iPhone) to iLX-700.
- Some functions may not be available while driving.

### About iPhone models usable with this unit

- The following devices have been tested and shown to work with this unit. Correct function of earlier versions cannot be guaranteed.  
iPhone 5s : Ver.7.1  
iPhone 5c: Ver.7.1  
iPhone 5 : Ver.7.1

## Access to Apple CarPlay

- 1 **Press the Home button.**  
The Home screen is displayed.
  - 2 **Touch [Apple CarPlay].**  
The Apple CarPlay mode is activated.  
Touch the desired App icon on iLX-700, or use Siri function by pressing Siri button.
- The App must be Apple CarPlay compatible in order to appear in the Home screen.

# Auxiliary Device (Optional)

## Operating Auxiliary Devices (Optional)

To operate devices connected to the AUX terminals of iLX-700, follow the procedure described below.

- Turn on the “AUX In”. Refer to “Setting the AUX Mode” (page 27).

### WARNING

**It is dangerous (and illegal in many states) for the driver to watch TV/video while driving the vehicle. The driver may be distracted from looking ahead and an accident could occur.**

**Install the iLX-700 correctly so that the driver cannot watch TV/video unless the vehicle is stopped and the emergency brake is applied.**

**If the iLX-700 is not installed correctly, the driver will be able to watch TV/video while driving the vehicle and may be distracted from looking ahead and cause an accident. The driver or other people could be severely injured.**

- The video will be shield while driving.

### 1 Press the **Home** button.

### 2 Touch **[AUX]**\*.

The Auxiliary (AUX) mode screen is displayed.

- \* The name which is given as the mode name in “Setting the Auxiliary Name” (page 27) is displayed.

### AUX Operation Screen Display During Video File Playback

#### Touch the screen.

The AUXiliary (AUX) operation screen is displayed.

### ■ Example for AUX main screen

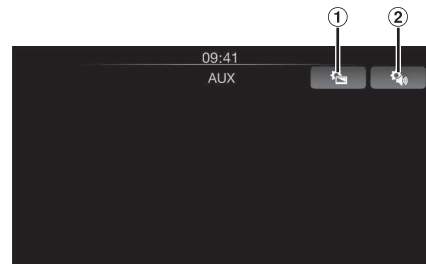

#### ①

Calls up the Display Setup screen. (see “Display Setup Operation” on page 21)

- The operation screen changes to the visual screen in the Auxiliary (AUX) mode for 5 seconds after an operation has been performed.

Touch the display panel to display the operation screen again.

#### ②

Calls up the Audio Setup screen. (see “Audio Setup Operation” on page 18)

- Setting the AUX name for DVB-T mode displays their individual operation switches and enables operation. Refer to “Setting the Auxiliary Name” (page 27).

## Operating the Mobile Digital TV Receiver (DVB-T)

To operate the Mobile Digital TV Receiver (DVB-T) (Optional), set “Setting the Auxiliary Name” (page 27) to DVB-T.

### Changing to the Mobile Digital TV Receiver (DVB-T) Mode

#### 1 Press the **Home** button.

The Home screen is displayed.

#### 2 Touch **[DVB-T]**.

The display shows the DVB-T mode screen.

## About the DVB-T operation screen

When you touch the screen in the DVB-T mode, the operation screen is displayed. For details on how to operate, refer to the Owner's Manual of the connected Digital TV Receiver (DVB-T).

### Menu operation TV mode screen display example

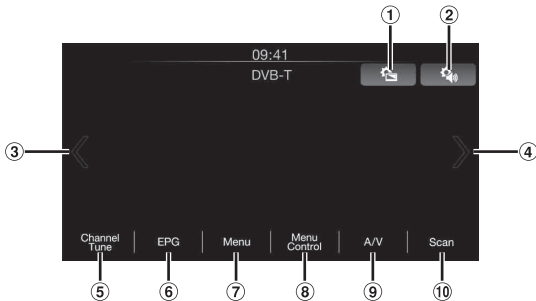

- ① [⚙️]  
Calls up the Display Setup screen. (see "Display Setup Operation" on page 21)
  - ② [🔊]  
Calls up the Audio Setup screen. (see "Audio Setup Operation" on page 18)
  - ③ [⏪]  
Switches the Channel number / Favourite channel number down.
  - ④ [⏩]  
Switches the Channel number / Favourite channel number up.
  - ⑤ [Tune] (Channel or Favourite)  
Switches between the Channel mode and the Favourite channel mode.
  - ⑥ [EPG]  
Call up the Electronic Programme Guide (EPG).
  - ⑦ [Menu]  
Call up the menu screen.
  - ⑧ [Menu Control]  
Call up the menu operation mode.
  - ⑨ [A/V]  
Switches the source.
  - ⑩ [Scan]  
Touch the switch to start the scan procedure.
- If the setting for "Setting Direct Touch Operation" (page 27) is set to "On", direct touch operation is possible. Directly touch operation switches displayed on the screen to operate. To display the operation screen, touch [Control].

# Camera Operation (Optional)

The video from an optional camera can be viewed from this head unit's display.

Depending on your camera, please choose the camera type (Rear or Other) first. For details, refer to "Setting the Camera Input" (page 26).

### Rear camera:

If an HCE-C305R/HCE-C300R/HCE-C210RD/HCE-C200R/HCE-C155/HCE-C115/HCE-C105 camera is connected, when the vehicle is reversed, the rear camera view (guide marks for vehicle width and available distance) is displayed automatically on the screen of this unit.

### Other camera:

Set when connecting to a camera other than the Rear camera, such as a room camera and side camera.

*You can adjust the quality of the camera image.*

**Setting items: Bright / Color / Contrast**

Refer to "Display Setup" (page 21).

## Rear Camera Operation

Set "Position" to "Rear". Refer to "Setting the Camera Input" on page 26.

### Displaying the rear view video while the car is in reverse

- 1 **Shift the gear lever to the reverse (R) position.**  
The rear view image is displayed while the car remains in reverse.
- 2 **If you shift the gear lever to a position other than reverse (R), the monitor returns to the previous screen.**
  - Never depend solely on the camera when backing up. Always turn and look and only use the camera for additional assistance.
  - This function is effective when the reverse wire is properly connected.

### Display the Rear View Video Manually

- 1 **Press the Home button.**  
The Home screen is displayed.
- 2 **Touch [Camera].**

## Guide Display On/Off Setting

### 1 Touch the screen when the image from the camera is displayed.

The operation screen is displayed on the screen.

- After a 5-second time-out, the operation screen returns to the camera display screen.

### 2 Touch [Guide Off] on the Rear camera display screen.

The guide disappears, and then the [Guide Off] switch changes to [Guide On].

### 3 Touch [Guide On] to turn on the guide.

## Adjusting the Caution Display Location

### 1 Touch the screen when the image from the camera is displayed.

The operation screen is displayed on the screen.

- After a 5-second time-out, the operation screen returns to the camera display screen.

### 2 Touch [Caution ↑] or [Caution ↓].

- For each touch, the caution location moves to the top or bottom of the screen.

## Calling the Adjusted Values of the Camera

You can call the preset values of the camera in "Display Setup" (page 21).

### 1 Touch the screen when the image from the camera is displayed.

The operation screen is displayed on the screen.

After a 5-second time-out, the operation screen returns to the camera display screen.

### 2 Touch [Preset].

## About the Rear Camera Guide

To display the guide, set "Guide Display On/Off Setting" (page 16) to On. Also, to adjust the guide, refer to "Adjusting the Rear Camera Guide" (page 26). You can also turn off the guide in the Rear camera display screen.

### ■ Indication mark meaning

When the car is put into reverse gear, the monitor switches to the rear view camera image. Guides appear to help visualise the car's width and distance from the rear bumper.

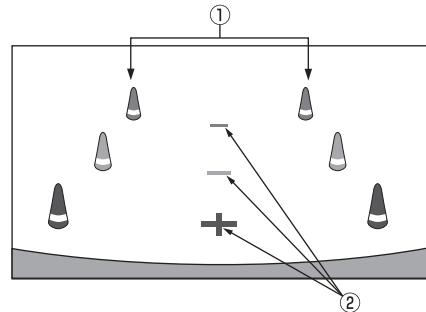

#### ① Car width extension marks (red, yellow and green in order of distance)

If properly calibrated, the marks indicate the car's width. This helps guide the car's path when backing up in a straight line.

The marks represent the distance from the rear of the car (at the end of the bumper).

- The marks do not move in synchronisation with the steering wheel.
- Set the marks to suit the car's width.

#### ② Distance guidance marks

The marks represent the distance from the rear of the car (from the end of the bumper).

- The marks do not move in synchronisation with the steering wheel.
- We recommend that you measure the actual distance to the marks when parked on a level surface.
- Depending on the condition of the car or road surface, the range of vision may vary.
- The camera has a limited range of vision. Objects at extreme angles to the camera (e.g. under the bumper or at opposite ends of the bumper) may not be in the its field-of-vision.
- The rear camera image may have a tint which is different from the actual surroundings.
- Depending on the car, the guidance may deviate to the right or left. This is not a malfunction.



## Distance guidance mark

The distance guides represent the ground level distance from the rear bumper. It is difficult to accurately estimate the distance to objects above ground level.

In the following example, the distance to A is 0.5 m and the distance to B is 1 m.

<Screen>

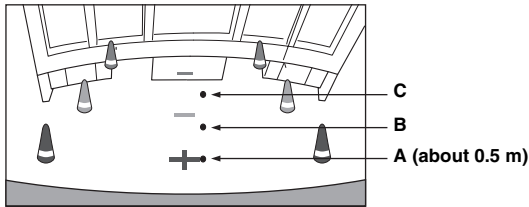

<Positions of A, B and C>

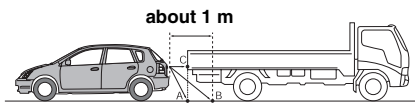

In the screen, according to the distance guidance marks, the truck seems to be parked about 1 m away (at the position B). In actual fact, however, if you reversed to position A, you would collide with the truck.

In the screen, positions A, B and C seem to be located in order of proximity. However, in actual fact, the position A and C are the same distance, and B is farther away than positions A and C.

- The car width extension mark represents the distance to the road surface. The distance to an object on the road is not accurately represented by the guides.
- In the following conditions, screen visibility may be impaired. This is not a malfunction.
  - When it is dark (during the night, etc.).
  - Under very high or very low temperature conditions.
  - When water drops adhere to the camera, or when the humidity is high (such as rainy weather, etc.).
  - When foreign bodies (such as mud, etc.) adhere to the camera or its peripheral area.
  - When sunlight or headlights directly strike the camera lens.

## Error between the screen and the actual road surface

In the following conditions, errors are produced between the screen guidance and the actual road surface. (The illustrations represent a case when the camera is installed in the standard position.)

### When there is a steep upward slope behind the car (example)

<Screen>

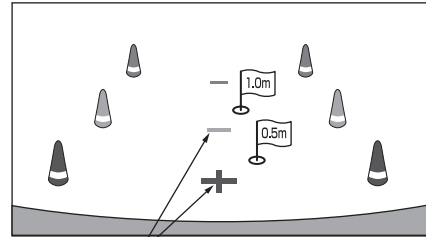

Distance guidance marks

<Situation of the car>

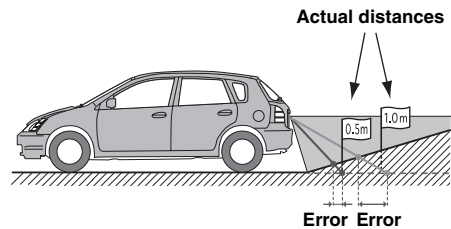

Error Error

The distance guidance mark represents the distance to a flat road surface. Therefore in the case of an upward slope behind the car, the distance guides are displayed closer to the rear bumper than the actual distance. For example, if there is an obstacle on the upward slope, it may appear farther away than its actual position. Also, an error may occur between the guidance and the actual path of the car on the road surface.

■ When there is a steep downward slope behind the car (example)

<Screen>

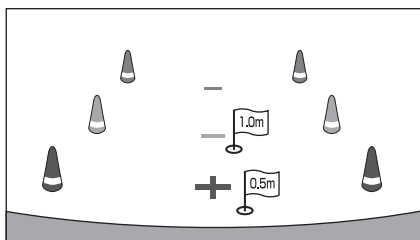

<Situation of the car>

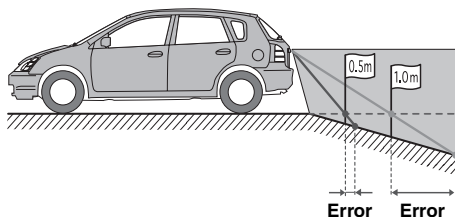

In the case of a downward slope behind the car, the distance guides are displayed farther from the rear bumper than the actual distance. If there is an obstacle on the downward slope, it seems closer than its actual position. Also, an error may occur between the guidance and the actual path of the car on the road surface.

## Other Camera Operation

Set "Other" for "Position" (page 26).

- 1 Press the **Home** button.  
The Home screen is displayed.
- 2 Touch [**Camera**].

### About the Adjustment of the Caution Display Location

The Caution display location for other cameras can be adjusted. Refer to "Adjusting the Caution Display Location" (page 16) for the operations.

### About the Adjusted Value of Image Quality

You can call the preset values of the camera in "Display Setup" (page 21). Refer to "Calling the Adjusted Values of the Camera" (page 16) for the operations.

# Setup

## Audio Setup

### Audio Setup Operation

The following steps 1 to 5 are common operations to each "Setting item" of Audio Setup. Refer to each section for details.

- 1 Touch [**⚙**] on the Home screen.  
The Setup main screen is displayed.
- 2 Touch [**Audio**].  
The Audio Setup screen appears.
  - You can display the Audio Setup screen from each application screen. Touch [**⚙**] on any application screen.
- 3 Select the desired item.  
If ">" appears, there is another hierarchy. Touch the desired item.  
If ">" does not appear, proceed to step 4.

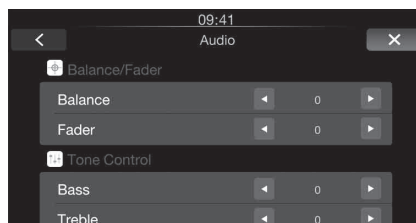

Setting items: *Balance / Fader / Bass<sup>\*1\*2</sup> / Treble<sup>\*1\*2</sup> / Subwoofer<sup>\*3</sup> / Subwoofer Level<sup>\*2\*4</sup> / Subwoofer Phase<sup>\*4</sup> / Bass Engine SQ<sup>\*1</sup> / Bass type<sup>\*1\*5</sup> / Bass level<sup>\*1\*5</sup> / Application Volume / Media Xpander<sup>\*1\*2</sup> / EQ Presets<sup>\*1\*2</sup> / Defeat*

<sup>\*1</sup> These items are disabled when DEFEAT is set to ON.  
<sup>\*2</sup> These items are disabled when Bass Engine SQ is set to ON.  
<sup>\*3</sup> This item is disabled when a downloaded Bass Engine SQ parameter is used via the TuneIt App.  
<sup>\*4</sup> These items are disabled when Subwoofer is set to OFF.  
<sup>\*5</sup> These items are disabled when Bass Engine SQ is set to OFF.

- 4 Touch [**◀**] or [**▶**] etc., to change its setting.

**5 Touch [X] to return to the main application screen.**  
Touch [◀] to return to the previous screen.

- Immediately after changing the Audio Setup (while the system is writing data automatically) do not turn the ignition key to OFF. Otherwise, the settings may not be changed.
- For details on how to operate the list screen, refer to page 9.

### About TuneIt

You can also set the Audio Setup of this unit through the TuneIt App installed to your iPhone.

It is also possible to download specific parameters for certain vehicles from Alpine's TuneIt database.

Using the TuneIt App, customized parameters can also be uploaded for others to share and rate.

In Sound control mode, "TuneIt connected." is displayed on the Audio Setup screen, and you cannot perform any operation.

- TuneIt is downloadable from Apple's App Store.
- Time Correction, Crossover and Parametric EQ can be set only through the TuneIt App.
- Also refer to "Applying TuneIt" on page 10.

## Adjusting Balance (Between Left and Right)

Adjust the right and left speaker volumes.

**Setting item: Balance**

**Setting contents: L (left) 15 to R (right) 15 (Initial setting: 0)**

## Adjusting Fader (Between Front and Rear)

Adjust the front and rear speaker volume.

**Setting item: Fader**

**Setting contents: F (front) 15 to R (rear) 15 (Initial setting: 0)**

## Setting the Bass Level

You can emphasize or weaken the bass level.

**Setting item: Bass**

**Setting contents: -7 to +7 (Initial setting: 0)**

## Setting the Treble Level

You can emphasize or weaken the treble level.

**Setting item: Treble**

**Setting contents: -7 to +7 (Initial setting: 0)**

## Setting the Subwoofer

### Turning Subwoofer ON/OFF

If an optional subwoofer is connected to the unit, make the following setting.

**Setting item: Subwoofer**

**Setting contents: ON / OFF (Initial setting: OFF)**

### Adjusting the Subwoofer Level

You can set the Subwoofer level when a Subwoofer is connected.

**Setting item: Subwoofer Level**

**Setting contents: 0 to 15 (Initial setting: 0)**

### Setting the Subwoofer Phase

The subwoofer output phase is toggled Subwoofer Normal (0°) or Subwoofer Reverse (180°).

**Setting item: Subwoofer Phase**

**Setting contents: 0° / 180° (Initial setting: 0°)**

## Setting the Bass Engine SQ

Bass Engine SQ is used to easily add impact of varying levels to your music. Using the different levels available, the Bass impact can be tweaked to conform to the type of music being tuned.

- Using the TuneIt App, you can download the optimal Bass Engine SQ tuning data for your speaker system.

### Turning the Bass Engine SQ ON/OFF

Set to "ON" to use the Bass Engine SQ function.

**Setting item: Bass Engine SQ**

**Setting contents: OFF / ON (Initial setting: OFF)**

## Setting the Bass Engine SQ Type

You can set your favorite Bass Engine SQ type.

**Setting item:** *Bass type*

**Setting contents:** *Standard / Punch / Low Bass / Mid Bass / Rich (Initial setting: Standard)*

**Standard:** A mild low-end boost to overcome road noise.

**Punch:** A heavier boost with more low-end impact (punch).

**Low Bass:** Enhance the very low bass to give a much heavier presence without the punchy mid-bass.

**Mid Bass:** Focused more on mid-bass for systems with smaller subwoofers.

**Rich:** Add boost to all low-end bands for a more bass-filled sound.

## Adjusting the Bass Engine SQ Level

With BASS ENGINE SQ ON, adjusting the Bass level uniformly effects various sound parameters for optimum Bass effect.

**Setting item:** *Bass level*

**Setting contents:** *0 to 6 (Initial setting: 3)*

- *The Bass parameters affected contain Bass Level, Treble Level, EQ PRESETS, Parametric EQ\*, SUBWOOFER\*, Subwoofer Level, Media Xpander, X-Over\* and Time correction\*. These items are set automatically in BASS ENGINE SQ mode and cannot be adjusted separately.*
- *From Level 0 to Level 6, the effect of BASS ENGINE SQ increases level by level.*

\* when set this item via TuneIt App

### About Setup when the external power amplifier is connected

In order to optimize the Bass Engine SQ, we recommend the following procedure to set up the power amplifier.

After setting up, the Bass Level will be adjusted according to the music.

- 1) Set GAIN of the power amplifier to "MIN."
- 2) Set the Crossover Mode Sector switch to "OFF."
- 3) Set the Bass Engine SQ of this unit to "ON," and the Bass Engine Level to "3."
- 4) Play a song of the genre you frequently listen to, and adjust GAIN of the power amplifier.

## Setting the Volume for Each Application

The volume level for each application can be adjusted.

**Setting item:** *Application Volume*

**Further setting item:** *Radio / Apple CarPlay / Auxiliary (AUX)*

**Setting contents\*:** *-14 to +14 (Initial setting: 0)*

\* Only for Radio and Auxiliary (AUX) mode.

- *Settable applications differ depending on the connected device and settings.*

### Setting the Volume for Apple CarPlay

When an iPhone 5 or later is connected, after touching [Apple CarPlay], you can adjust Media, Phone Calls, Ringtones & Alerts level, Notifications & Guidance level and Siri for Apple CarPlay mode.

**Setting item:** *Media / Phone Calls / Ringtones & Alerts / Notifications & Guidance / Siri*

**Setting contents for Media:** *-14 to +14 (Initial setting: 0)*

**Setting contents for Phone Calls / Ringtones & Alerts / Siri:** *1 to 11 (Initial setting: 5)*

**Setting contents for Notifications & Guidance:** *1 to 7 (Initial setting: 4)*

- *Any changes made to either Adjusting the Operating Sound or Apple CarPlay (page 23) for Notifications & Guidance are reflected in the others' settings.*

## Setting the MX (Media Xpander)

The FM radio, Apple CarPlay and Auxiliary (AUX), will be able to reproduce the music clearly, even in cars when there is a lot of road noise.

**Setting item:** *Media Xpander*

**1** Turn on the Media Xpander.

**2** Touch [◀] or [▶] to select your preferred level, or Off.

**FM**

The medium to high frequencies become more clear, and produces well balanced sound in all the bands.

**Apple Carplay (CMPM)**

This corrects information that was omitted at the time of compression. This reproduces a well-balanced sound close to the original.

**Auxiliary (AUX)**

Choose the MX mode (CMPM, MOVIE, or MUSIC) that corresponds to the media connected.

- *To cancel MX mode for all music applications, turn off Media Xpander in step 1.*
- *There is no MX mode for LW, MW radio.*

## Equalizer Presets (EQ Presets)

10 typical equalizer settings are preset at the factory for a variety of musical source material.

**Setting item:** *EQ Presets*

**Setting contents:** *FLAT (Initial setting) / POP / ROCK / NEWS / JAZZ / ELECTRONIC / HIP HOP / EASY LISTENING / COUNTRY / CLASSICAL*

- *Only one type is selectable for playback.*
- *"USER" is displayed when Bass/Treble level is adjusted or any change of Parametric is adjusted via TuneIt.*

## Setting Defeat

If Defeat is "On", Bass Level, Treble Level, Bass Engine SQ, MX and EQ Presets functions are turned OFF. This disables any settings made for these functions.

**Setting item:** *Defeat*

**Setting content:** *OFF / ON (Initial setting: OFF)*

# Display Setup

## Display Setup Operation

The Parking Brake must be engaged to access the Display mode screen. Attempting to access this screen while driving will display the warning-Unable to operate while driving.

**The following steps 1 to 6 are common operations to each "Setting item" of Display Setup. Refer to each section for details.**

### 1 Touch [ ] on the Home screen.

The Setup main screen is displayed.

### 2 Touch [Display].

The Display Setup screen appears.

- You can display the Display Setup screen from each application screen. Touch [  ] on any application screen (video mode).

### 3 Touch the desired application.

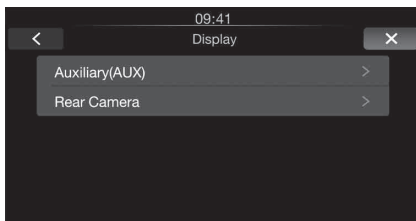

- "Auxiliary (AUX)" can be selected while in AUX mode.
- The camera position set under the "Camera" settings are displayed. The camera names are not displayed when "Off" is set (page 26).

### 4 Touch [ > ] of the desired item.

Settable items differ depending on the application.

- [Auxiliary (AUX)]:  
Display Mode / Brightness / Color / Contrast / Sharpness
- [Camera]:  
Brightness / Color / Contrast

### 5 Touch [ < ] or [ > ] to change its setting.

### 6 Touch [ X ] to return to the main application screen.

Touch [ < ] to return to the previous screen.

- Immediately after changing the settings of Display Setup (While the system is writing data automatically) do not turn the ignition key to OFF. Otherwise, the settings may not be changed.

## Switching Display Modes

**Setting item: Display Mode**

**Setting contents: WIDE (Initial setting) / NORMAL**

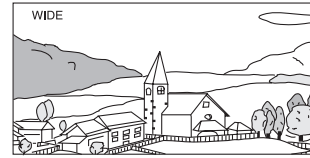

In WIDE mode, the picture is stretched horizontally to fill the entire display.

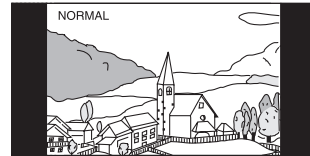

In NORMAL mode, the monitor displays a normal picture at the center of the screen with a vertical black band at each side.

## Adjusting Brightness

**Setting item: Brightness**

**Setting content: -15 to +15 (Initial setting: 0)**

You can adjust the brightness between MIN (-15) and MAX (+15). When it reaches the minimum or maximum point, the display shows "MIN" or "MAX" respectively.

## Adjusting Color of Picture

**Setting item: Color**

**Setting content: -15 to +15 (Initial setting: 0)**

You can adjust the color between MIN (-15) and MAX (+15). When it reaches the minimum or maximum point, the display shows "MIN" or "MAX" respectively.

## Adjusting Image Contrast

**Setting item: Contrast**

**Setting content: -15 to +15 (Initial setting: 0)**

You can adjust the contrast between MIN (-15) and MAX (+15). When it reaches the minimum or maximum point, the display shows "MIN" or "MAX" respectively.

## Adjusting Picture Quality

**Setting item: Sharpness**

**Setting content: -3 to +3 (Initial setting: 0)**

Picture quality adjustment range is -3 to +3. "SOFT" and "HARD" appear as the minimum and maximum values.

## Saving and Calling the Adjusted Picture Quality

When adjusting camera, you can store the settings made for "Adjusting Brightness, Color and Contrast."

**Setting item: Preset1 / Preset2**

- 1 After completing "Adjusting Brightness, Color and Contrast" (page 21), touch and hold [Preset1] or [Preset2] to save the settings.
- 2 Touch [Preset1] or [Preset2] to call the saved settings.

## General Setup

### General Setup Operation

The Parking Brake must be engaged to access the General mode screen. Attempting to access this screen while driving will display the warning-Unable to operate while driving.

**The following steps 1 to 4 are common operations to each "Setting item" of General Setup. Refer to each section for details.**

- 1 Touch [⚙️] on the Home screen.**  
The Setup main screen is displayed.
- 2 Touch [General].**  
The General Setup screen appears.
- 3 Touch [◀] or [▶] etc., of the desired item to change its setting. For items that have ">," touch the item to display the screen for the next hierarchy.**

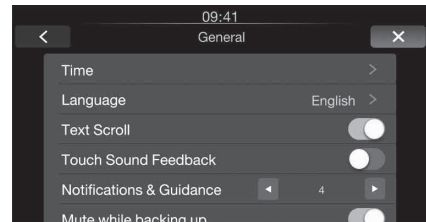

**Setting items: Time / Language / Text Scroll / Touch Sound Feedback / Notifications & Guidance / Mute while backing up / Screen/Lighting / Security Code / Vehicle function\* / About / Demo mode**

\* This item is displayed when the unit is connected to the vehicle equipped CAN Interface box.

- Depending on the item, repeat step 3.
- Depending on the setting, displayed items may differ.

- 4 Touch [X] to return to the main application screen.**  
Touch [◀] to return to the previous screen.
- Immediately after changing the settings of General Setup (While the system is writing data automatically) do not turn the ignition key to OFF. Otherwise, the settings may not be changed.

---

## Time Setting

---

### Setting the Clock Display

You can select the clock display type, 12-hour or 24-hour, depending on your preference.

**Setting item: Clock Mode**

**Setting contents: 12h / 24h (Initial setting)**

### Setting the Time

**Setting item: Clock Adjust**

**Additional items: Hour / Minute**

**Setting content: 1-12 or 0-23 / 0-59**

Hour: Adjust the hour.

Minute: Adjust the minute.

- Touch and hold [◀] or [▶] to run through a change sequence automatically.

---

## Language Setting

---

### Setting the Menu Language

The Setup menu, feedback information, etc. for this unit can be changed to appear in the selected language.

**Setting item: Language**

**Setting contents:**

English/Deutsch/Français/Español/  
Português/Italiano/Nederlands/Suomi/  
Norsk/Svenska/Dansk/русский язык/  
Slovenčina/Polski/Ceština/Magyar/  
Ελληνικά/ภาษาไทย/Türkçe/中文

- Touch [OK] to confirm the language and display the screen in the specified language.

---

## Text Scroll Setting

---

### Setting the Scroll

The text messages in the audio screen are scrolled.

**Setting item: Text Scroll**

**Setting contents: OFF (Initial setting) / ON**

OFF: Turns off the scroll mode.

ON: Turns on the Auto scroll mode. Scroll display is repeated while the vehicle is parked.

---

## Key Sound Setting

---

### Touch Sound Feedback On/Off setting

**Setting item: Touch Sound Feedback**

**Setting contents: On (Initial setting) / Off**

On: Turn on the touch sound feedback.

Off: Turn off the touch sound feedback. Even though you turn off this item, the Navigation guidance will be output while operating the navigation screen.

### Adjusting the Operating Sound

After turning on the Touch Sound Feedback function, you can change the volume of the sound heard when a button is touched.

**Setting item: Notifications & Guidance**

**Setting contents: 1 to 7 (Initial setting: 4)**

- The setting value is always valid for navigation mode, even though the Touch Sound Feedback is turned off.
- Any changes made to either Adjusting the Operating Sound or Apple CarPlay (page 20) for Notifications & Guidance are reflected in the others' settings.

---

## Setting Mute when Reversing

---

You can set whether to mute the playing music when the gear lever is moved to the reverse (R) position.

**Setting item: Mute while backing up**

**Setting contents: OFF (Initial setting) / ON**

---

## Screen/Lighting Setting

---

### Setting the Brightness of the Backlighting

Backlighting is provided by a fluorescent light built into the liquid crystal panel. The illumination control adjusts the brightness of the backlighting based on the car ambient lighting for easier viewing.

**Setting item: Dimmer**

**Setting contents: Auto (Initial setting) / On / Off**

Auto: Adjust the brightness of the background illumination of the monitor automatically to the brightness of the car interior.

On: Keep the background illumination of the monitor dark.

Off: Deactivate Auto Dimmer mode to keep the background illumination of the monitor bright.

- When "Auto" or "On" is set, the setting is also applied for the button lighting in "Button Backlighting Adjustment" (page 24), and "Display Backlighting Adjustment" (page 24).

## Button Backlighting Adjustment

You can adjust the brightness of the button lighting at night with the dimmer.

**Setting item: Key Illumination Level**

**Setting level: -2 to +2 (Initial setting: 0)**

## Display Backlighting Adjustment

You can adjust the brightness of the backlight. This function could be used, for instance, to change the screen brightness while traveling at night.

**Setting item: Screen Dimmer Level**

**Setting content: -15 to +15 (Initial setting: 0)**

You can adjust the level between MIN (-15) and MAX (+15). When it reaches the minimum or maximum point, the display shows "MIN" or "MAX" respectively.

## Changing the Opening Image

You can set the image file for the opening screen. Copy your desired image file from a USB memory device.

**Setting item: Opening Customization**

**Setting contents: Default (Initial setting) / User**

The file selected in the User mode will be copied according to the following procedure.

**1 Connect the USB memory device which contains the BMP file to be copied to the unit.**

**2 After the confirmation message is displayed, touch [OK].**

The Opening image is changed.

### ■ Copiable image files

File format: BMP  
Image size: 800 × 480 pixels, RGB 24 bit or less  
Folder Name: OPENINGFILE  
File Name: openingfile.bmp

## Security Code Setting

### Setting Security code

You can set the system to be unusable without entering a password. When you turn this setting to "On" and set a password, password input is required when the system is connected to a battery and turned on for the first time.

**Setting item: Security Code**

**Setting contents: Off (Initial setting) / On**

### Setting the password

**1 Set "Security Code" to "On".**

**2 After the confirmation message appears, touch [OK].**

The password setting screen is displayed.

**3 Enter a password, then touch [Enter].**

- Enter the 6-digit number.
- Input numbers are displayed as "\*\*".

**4 Enter the same password again, then touch [Enter].**

The password is set and the system returns to the previous screen.

- If you forget a registered password, you cannot use this unit. In this case, service will be required.

### Clearing the password

**1 Set "Security Code" to "Off".**

The password setting screen is displayed.

**2 Enter the password you have set, then touch [Enter].**

The password is cleared and the system returns to the previous screen.

- Input numbers are displayed as "\*\*".



---

## Vehicle function Setting

---

### Setting the Climate screen interrupt time

The Climate screen will be tuned in if you adjust the air condition in your vehicle.

You can adjust the display time for Climate screen by this setting.

**Setting item:** *Climate screen interrupt time*

**Setting contents:** *None / 5s / 10s / Continued display*

- For details, please refer to “Access to Climate Mode” (page 10).
- Depending on your vehicle, this setting item may be disabled.

### Setting the Parking sensor interrupt time

The Parking Assist screen will be tuned in if the obstacle within a certain distance is detected by the front or rear sensor of your vehicle.

You can adjust the display time for Parking Assist screen by this setting.

**Setting item:** *Parking sensor interrupt time*

**Setting contents:** *None / 5s / 10s / Continued display*

- For details, please refer to “Parking Assist Interrupt Function” (page 10).
- Depending on your vehicle, this setting item may be disabled.

### Setting the Vehicle type

You can choose the type of your vehicle by this setting. The Parking Assist system will provide more accurate information based on your vehicle type.

**Setting item:** *Vehicle type*

**Setting contents:** *Sedan / Hatchback / Pickup*

- Depending on your vehicle, this setting item may be disabled.

---

## About iLX-700

---

### Displaying the Product Information

You can view the model name, serial number and the version information of the version product. Make note of this information and refer to it whenever you contact Alpine Tech Support or an Alpine-authorized dealer.

**Contents:** *iLX-700 (model name) / Serial Number / Firmware Version*

### Initializing the System

You can initialize all data, to restore the factory settings. Remove the USB memory, etc. from the system before operation.

**Setting item:** *Clear All Settings*

- 1 Touch **[RESET]** of “Clear All Settings.”
- 2 After the confirmation message appears, touch **[OK]**.  
The system starts initialization.

- Do not turn on/off the power or change the ignition key position until system restart is completed.

---

## Demonstration Setup

---

### Canceling the Demonstration

This unit has a Demonstration feature for the display. When you install and use the unit for the first time, the unit will enter demo mode automatically. To quit demo mode, turn off the Demo mode.

**Setting item:** *Demo mode*

**Setting contents:** *OFF / ON (Initial setting)*

- If you perform an operation during the Demo Mode, the demonstration is temporarily stopped.

# Application Setup

## Application Setup Operation

The Parking Brake must be engaged to access the Application mode screen. Attempting to access this screen while driving will display the warning-Unable to operate while driving.

The following steps 1 to 5 are common operations to each “Setting item” of Application Setup. Refer to each section for details.

- 1 Touch [⚙️] on the Home screen.**  
The Setup main screen is displayed.
- 2 Touch [Application].**  
The Application Setup screen appears.
- 3 Select the desired item.**  
If “>” appears, there is another hierarchy level. Touch the desired item.  
If “>” does not appear, proceed to step 4.

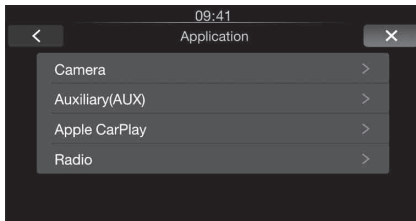

**Setting items: Camera / Auxiliary (AUX) / Apple Carplay / Radio**

- 4 Touch [◀] or [▶] etc., to change its setting.**
- 5 Touch [X] to return to the main application screen.**  
Touch [◀] to return to the previous screen.

• Immediately after changing the Application Setup (while the system is writing data automatically) do not turn the ignition key to OFF. Otherwise, the settings may not be changed.

## Camera Setting

[Camera] is selected on the Application setup menu in step 3. Refer to “Application Setup Operation” (page 26).

### Setting the Camera Input

With an optional camera connected, its video is output to the monitor. When the camera is connected, set this item.

**Setting item: Position**

**Setting contents: Off (Initial setting) / Rear / Other**

Rear: Rear camera  
Other: Side camera, Room camera, etc.

After selecting “Rear” or “Other” in the “Position” setting, touch [➤] of “Position”, the following additional items can be adjusted.

### Setting the Camera Signal Input

When the camera is connected, the video input signal type can be selected.

**Further setting item: Camera Signal**

**Setting contents: NTSC (Initial setting) / PAL**

NTSC/PAL: Choose the video input signal type manually.

### Adjusting the Rear Camera Guide

If you select “Rear,” you can adjust the camera guide position.

**Setting item: Guide Adjustment**

- 1 Touch [Guide Adjustment].**  
The camera guide adjustment screen is displayed.
- 2 Touch the guide you intend to adjust.**  
Guide line can also be selected by touching [▲] [▼].

■ Display example for rear camera mode

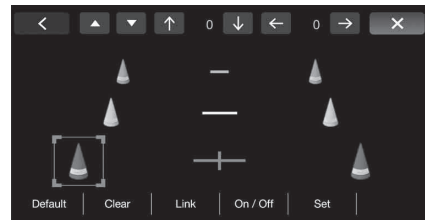

- 3 Touch [↑], [↓], [←] or [→] to adjust the position of the guide.**
  - Touching [Clear] clears adjustments and returns to the setting before guide line alteration.
- 4 After the adjustment is completed, touch [Set].**

## Adjusting guides simultaneously

### 1 Touch [Link].

The 3 vertical guides of the currently-selected guide link together, allowing them to be adjusted simultaneously.

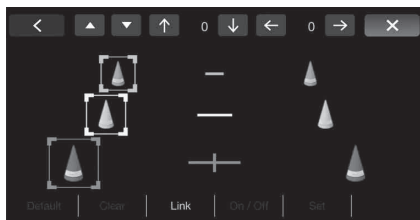

## Turning guide display On/Off

Turning the selected guide off.

### 1 Touch [On/Off].

The currently selected guide will turn off.

### 2 To turn the guide on, touch [On/Off] again.

- Guides that are turned off are still adjustable.

## Returning guides to default

### 1 Touch [Default].

A message window will appear.

### 2 Touch [OK].

Adjusted values will return to default settings.

## Setting the Camera Interrupt

Even when the unit is powered off, the monitor will display the rear view behind the vehicle when the gear lever is shifted to the reverse position.

**Setting item:** *Interrupt (Power OFF)*

**Setting contents:** *ON (Initial setting) / OFF*

- Rear camera can only be operated to display the rear view.
- When the gear lever is shifted out of reverse, the unit turns off.

## Auxiliary Setting

[Auxiliary (AUX)] is selected on the Application setup menu in step 3. Refer to “Application Setup Operation” (page 26).

## Setting the AUX Mode

**Setting item:** *AUX In*

**Setting contents:** *OFF / ON (Initial setting)*

- OFF: AUX source and related setting items are not displayed.
- ON: AUX source and related setting items are displayed.

- After turning on the “AUX In”, the following further items can be adjusted.

## Setting the Auxiliary Name

When AUX In is turned on, this setting is available.

**Setting item:** *AUX Name*

**Setting contents:** *AUX (Initial setting) / DVB-T*

## Setting Direct Touch Operation

If DVB-T is set as the AUX Name, this setting is available.

**Setting item:** *DirectTouch*

**Setting contents:** *On (Initial setting) / Off*

- On: Direct Touch operation is available on the DVB-T screen.
- Off: Direct Touch operation is not available on the DVB-T screen.

## Switching the Visual Input Signal System

After turning on the “AUX In”, this setting can be carried out. The video input type can be changed.

**Setting item:** *Signal*

**Setting contents:** *Auto (Initial setting) / NTSC/PAL*

Auto: The video input signal type (NTSC or PAL) will be automatically selected.

NTSC/PAL: Choose the video input signal type manually.

## Apple CarPlay Setting

[Apple CarPlay] is selected on the Application setup menu in step 3. Refer to “Application Setup Operation” (page 26).

## Steering wheel Setting

This setting influences Apple CarPlay mode.

**Setting item:** *Steering wheel*

**Setting contents:** *Left (Initial setting) / Right*

## Setting the Siri Microphone Effect

You can turn on or off the Siri Microphone Effect.

**Setting item:** *Microphone EC / NR*

**Setting contents:** *ON (Initial setting) / OFF*

## Selecting the Output Speaker

You can select which speaker in the car will output the audio from the phone.

**Setting item:** *Call Speaker Select*

**Setting contents:** *All (Initial setting) / Front L / Front R / Front LR*

- All: The sound is output from all speakers in car.
- Front L: The sound is only output from the front left speaker.
- Front R: The sound is only output from the front right speaker.
- Front LR: The sound is output from the front left and front right speakers.

## Adjusting the Microphone Level

You can adjust the transmit volume.

**Setting item:** *Microphone Level*

**Setting contents:** *1 to 11 (Initial setting: 5)*

- The setting cannot be adjusted during a phone call. Adjust the setting before placing a call.

## Radio Setting

[Radio] is selected on the Source setup menu in step 3. Refer to “Application Setup Operation” (page 26).

### PI SEEK Setting

**Setting item:** *PI Seek*

**Setting contents:** *Auto / Off (Initial setting)*

### Receiving RDS Regional (Local) Stations

When Off is selected, the unit automatically keeps receiving the local RDS station.

**Setting item:** *RDS Regional*

**Setting contents:** *On (Initial setting) / Off*

### Switching the Display Language of PTY (Programme Type)

**Setting item:** *PTY Language*

**Setting contents:** *ENG (Initial setting) / GER / FRE / SPA / POR / ITA / DUT / DAN / FIN / NOR / SWE / RUS*

|      |            |
|------|------------|
| ENG: | English    |
| GER: | German     |
| FRE: | French     |
| SPA: | Spanish    |
| POR: | Portuguese |
| ITA: | Italian    |
| DUT: | Dutch      |
| DAN: | Danish     |
| FIN: | Finnish    |
| NOR: | Norwegian  |
| SWE: | Swedish    |
| RUS: | Russian    |

### Setting PTY31 (Emergency Broadcast) Reception

PTY31 (Emergency Broadcast) reception can be set to On/Off.

**Setting item:** *PTY31*

**Setting contents:** *On (Initial setting) / Off*

- The unit automatically gives priority to an emergency broadcast whenever it begins, and interrupts the programme you are currently listening to when PTY31 is set to “On”.
- The unit will show “Alarm” in the display during PTY31 reception.
- This setting relates to the Alarm setting of DAB.

### Setting the TUNER (FM) Tone Quality (Tuner Condition)

This unit can set your preferred tone quality for FM radio source.

**Setting item:** *FM Tuner Setting*

**Setting contents:** *Normal (Initial setting) / HiFi / Stable*

|         |                      |
|---------|----------------------|
| Normal: | Standard setting     |
| HiFi:   | High-quality setting |
| Stable: | Control noise        |

- Noise may be more noticeable when HiFi is set, depending on the reception status. In this case, the Normal setting is recommended.

# Information

## Product Software Update

This product use software that can be updated through a USB memory device. Download the software from the Alpine website and update the product using the USB memory device.

### Updating this product

Check the Alpine website for details on updating.

<http://www.alpine-europe.com>

### Important information on the software

About the software license of the product

The software installed in the product contains opensource software. See the following Alpine website for details on the open source software.

<http://www.alpine.com/e/oss/download>

## In Case of Difficulty

If you encounter a problem, please turn the power off, then on again. If the unit is still not functioning normally, please review the items in the following checklist. This guide will help you isolate the problem if the unit is at fault. Otherwise, make sure the rest of your system is properly connected, or then consult your authorised Alpine dealer.

### Basic

#### No function or display.

- Vehicle's ignition is off.
  - If connected according to the instructions, the unit will not operate with the vehicle's ignition off.
- Improper power lead connections.
  - Check power lead connections.
- Blown fuse.
  - Check the fuse of the unit; replace with the proper value if necessary.
- Internal micro-computer malfunctioned due to interference noise, etc.
  - Turn the ignition key off, and then set to ON again.

#### No sound or unnatural sound.

- Incorrect setting of volume/balance/fader controls.
  - Readjust the controls.
- Connections are not properly or securely made.
  - Check the connections and firmly connect.

#### Screen not displayed.

- Brightness/Contrast control is set at the minimum position.
  - Adjust the Brightness/Contrast control.
- Temperature in the vehicle is too low.
  - Increase the vehicle's interior temperature to operation temperature range.
- The Parking Brake Lead is not connected.
- The Parking Brake is not engaged.
  - Connect the Parking Brake Lead, then engage the Parking Brake. (See page 34)

#### Movement of displayed picture is abnormal.

- Temperature in the vehicle is too high.
  - Allow the vehicle's interior temperature to cool.

### Radio

#### Unable to receive stations.

- No antenna, or open connection in the antenna cable.
  - Make sure the antenna is properly connected; replace the antenna or cable if necessary.

#### Unable to tune stations in the seek mode.

- You are in a weak signal area.
  - Make sure the tuner is in DX mode.
- If the area you are in is a primary signal area, the antenna may not be grounded and connected properly.
  - Check your antenna connections; make sure the antenna is properly grounded at its mounting location.
- The antenna may not be the proper length.
  - Make sure the antenna is fully extended; if broken, replace the antenna with a new one.

#### Broadcast is noisy.

- The antenna is not the proper length.
  - Extend the antenna fully; replace it if it is broken.
- The antenna is poorly grounded.
  - Make sure the antenna is grounded properly at its mounting location.
- The station signal is weak and noisy.
  - If above solution does not work, tune in another station.

## If this Message Appears

Various messages are displayed on the screen during operation. In addition to the messages telling you the current status or providing guidance for the next operation, there are also the following error messages. If one of these error messages is displayed, carefully follow the instructions in the solution column.

### System

#### Unable to operate while driving.

- A setup operation, etc., was carried out while the vehicle was running.
  - Move the vehicle to a safe location, stop, and engage the parking brake, then carry out this operation.

#### USB current error.

- Abnormal current is run to the USB connector device.
  - Turn the ignition key off, and then set to ON again.
  - Attempt to connect another iPhone/USB memory device.

### Audio/Visual

#### Connected USB Device is not supported.

- An iPhone that is not supported by the unit is connected.
  - Connect an iPhone that is supported by the unit.
- A USB device that is not supported by the unit is connected.
  - Attempt to connect another USB memory device.
- Communication error.
  - Turn the ignition key off, and then set to ON again.
  - Check the display by reconnecting between the iPhone and the unit, using the lightning to USB Cable.
  - Check the display by reconnecting between the USB memory device and the unit.
- Caused by the iPhone Software Version not being compatible with this unit.
  - Update the iPhone Software Version to be compatible with this unit.
- The iPhone is not verified.
  - Change another iPhone.

## **Specifications**

### **MONITOR SECTION**

|                                      |   |
|--------------------------------------|---|
| Screen Size                          | 7.0"                                    |
| LCD Type                             | Transparent type TN LCD                 |
| Operation System                     | TFT active matrix                       |
| Number of Picture Elements           | 1,152,000 pcs.<br>(800 × 480 × 3 (RGB)) |
| Effective Number of Picture Elements | 99% or more                             |
| Illumination System                  | LED                                     |

### **FM TUNER SECTION**

|                               |                               |
|-------------------------------|-------------------------------|
| Tuning Range                  | 87.5 – 108.0 MHz              |
| Mono Usable Sensitivity       | 8.1 dBf (0.7 $\mu$ V/75 ohms) |
| Alternate Channel Selectivity | 80 dB                         |
| Signal-to-Noise Ratio         | 60 dB                         |
| Stereo Separation             | 35 dB                         |
| Capture Ratio                 | 2.0 dB                        |

### **MW TUNER SECTION**

|                    |                     |
|--------------------|---------------------|
| Tuning Range       | 531 – 1,602 kHz     |
| Usable Sensitivity | 25.1 $\mu$ V/28 dBf |

### **LW TUNER SECTION**

|                            |                     |
|----------------------------|---------------------|
| Tuning Range               | 153 – 281 kHz       |
| Sensitivity (IEC Standard) | 31.6 $\mu$ V/30 dBf |

### **USB SECTION**

|                        |   |
|------------------------|---|
| USB requirements       | USB 1.1/2.0   |
| Max. Power Consumption | 1,000 mA  |
| USB Class              | USB (Play From Device)/<br>USB (Mass Storage Class) |
| File System            | FAT16/32  |

### **GENERAL**

|                       |                                     |
|-----------------------|-------------------------------------|
| Power Requirement     | 14.4 V DC<br>(11–16 V allowable)    |
| Operating temperature | -4°F to +140°F<br>(-20°C to + 60°C) |
| Maximum Power Output  | 50 W × 4                            |
| Weight                | 0.9 kg (1 lbs 15 oz )               |
| Audio output level    |                                     |
| Preout (Front, Rear): | 2V/10k ohms (max.)                  |
| Preout (Subwoofer):   | 2V/10k ohms (max.)                  |

### **CHASSIS SIZE**

|        |                     |
|--------|---------------------|
| Width  | 178 mm (7")         |
| Height | 100 mm (3 – 15/16") |
| Depth  | 75.5 mm (3")        |

- *Due to continuous product improvement, specifications and design are subject to change without notice.*
- *The LCD panel is manufactured using an extremely high precision manufacturing technology. Its effective pixel ratio is over 99.99%. This means that there is a possibility that 0.01% of the pixels could be either always ON or OFF.*

---

---

# Installation and Connections

Before installing or connecting the unit, please read the following and pages 5 to 6 of this manual thoroughly for proper use.

## Warning

---

### MAKE THE CORRECT CONNECTIONS.

Failure to make the proper connections may result in fire or product damage.

---

### USE ONLY IN CARS WITH A 12 VOLT NEGATIVE GROUND.

(Check with your dealer if you are not sure.) Failure to do so may result in fire, etc.

---

### BEFORE WIRING, DISCONNECT THE CABLE FROM THE NEGATIVE BATTERY TERMINAL.

Failure to do so may result in electric shock or injury due to electrical shorts.

---

### DO NOT ALLOW CABLES TO BECOME ENTANGLED IN SURROUNDING OBJECTS.

Arrange wiring and cables in compliance with the manual to prevent obstructions when driving. Cables or wiring that obstruct or hang up on places such as the steering wheel, shift lever, brake pedals, etc. can be extremely hazardous.

---

### DO NOT SPLICE INTO ELECTRICAL CABLES.

Never cut away cable insulation to supply power to other equipment. Doing so will exceed the current carrying capacity of the wire and result in fire or electric shock.

---

### DO NOT DAMAGE PIPE OR WIRING WHEN DRILLING HOLES.

When drilling holes in the chassis for installation, take precautions so as not to contact, damage or obstruct pipes, fuel lines, tanks or electrical wiring. Failure to take such precautions may result in fire.

---

### DO NOT USE BOLTS OR NUTS IN THE BRAKE OR STEERING SYSTEMS TO MAKE GROUND CONNECTIONS.

Bolts or nuts used for the brake or steering systems (or any other safety-related system), or tanks should NEVER be used for installations or ground connections. Using such parts could disable control of the vehicle and cause fire etc.

---

### KEEP SMALL OBJECTS SUCH AS SCREWS OUT OF THE REACH OF CHILDREN.

Swallowing them may result in serious injury. If swallowed, consult a physician immediately.

---

### DO NOT INSTALL IN LOCATIONS WHICH MIGHT HINDER VEHICLE OPERATION, SUCH AS THE STEERING WHEEL OR SHIFT LEVER.

Doing so may obstruct forward vision or hamper movement etc. and results in serious accident.

## Caution

---

### HAVE THE WIRING AND INSTALLATION DONE BY EXPERTS.

The wiring and installation of this unit requires special technical skill and experience. To ensure safety, always contact the dealer where you purchased this product to have the work done.

---

### USE SPECIFIED ACCESSORY PARTS AND INSTALL THEM SECURELY.

Be sure to use only the specified accessory parts. Use of other than designated parts may damage this unit internally or may not securely install the unit in place. This may cause parts to become loose resulting in hazards or product failure.

---

### ARRANGE THE WIRING SO IT IS NOT CRIMPED OR PINCHED BY A SHARP METAL EDGE.

Route the cables and wiring away from moving parts (like the seat rails) or sharp or pointed edges. This will prevent crimping and damage to the wiring. If wiring passes through a hole in metal, use a rubber grommet to prevent the wire's insulation from being cut by the metal edge of the hole.

---

### DO NOT INSTALL IN LOCATIONS WITH HIGH MOISTURE OR DUST.

Avoid installing the unit in locations with high incidence of moisture or dust. Moisture or dust that penetrates into this unit may result in product failure.

## Precautions

- Be sure to disconnect the cable from the (–) battery post before installing your iLX-700. This will reduce any chance of damage to the unit in case of a short-circuit.
- Be sure to connect the colour coded leads according to the diagram. Incorrect connections may cause the unit to malfunction or damage to the vehicle's electrical system.
- When making connections to the vehicle's electrical system, be aware of the factory installed components (e.g. on-board computer). Do not tap into these leads to provide power for this unit. When connecting the iLX-700 to the fuse box, make sure the fuse for the intended circuit of the iLX-700 has the appropriate amperage. Failure to do so may result in damage to the unit and/or the vehicle. When in doubt, consult your Alpine dealer.
- The iLX-700 uses female RCA-type jacks for connection to other units (e.g. amplifier) having RCA connectors. You may need an adaptor to connect other units. If so, please contact your authorised Alpine dealer for assistance.
- Be sure to connect the speaker (–) leads to the speaker (–) terminal. Never connect left and right channel speaker cables to each other or to the vehicle body.
- The Display must be completely retracted in the casing when installing. If it is not, problems may occur.
- When installing in automobiles, make sure the Display can open/close without coming in contact with the gear shift.

---

### IMPORTANT

Please record the serial number of your unit in the space provided below and keep it as a permanent record. The serial number plate is located on the bottom of the unit.

SERIAL NUMBER: \_\_\_\_\_  
INSTALLATION DATE: \_\_\_\_\_  
INSTALLATION TECHNICIAN: \_\_\_\_\_  
PLACE OF PURCHASE: \_\_\_\_\_

## Installation

### Note on installation

- Install at an angle between horizontal and 30°. Note that installing at an angle outside of this range will result in a loss of performance and possible damage.

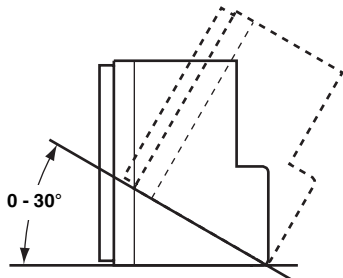

- Do not block the unit's heat sink, which would prevent air circulation. If blocked, heat will accumulate inside the unit and may cause a fire.

### Rear of the Unit

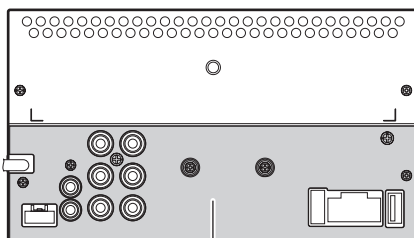

Heat sink

## Uninstalling the original car stereo

- 1 Uninstall the car stereo with its mounting bracket.
- 2 Remove the cables and the mounting bracket attached to the car stereo.  
(The mounting bracket will be used in "Installing the unit.")

## Mounting the Microphone

For safe use, make sure of the following:

- Location is stable and firm.
- Driver's view and operations are not obstructed.
- Microphone is located where the driver's voice can be easily picked up (for example, on the sun visor).

When you speak into the microphone, you should not have to change your driving posture. This may cause a distraction, taking your attention away from safely driving your vehicle. Carefully consider direction and distance while mounting the microphone. Confirm that the driver's voice can be easily picked up at the selected location.

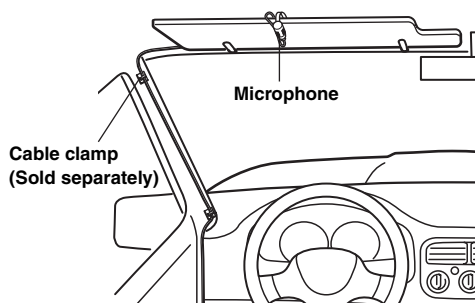

## Installing the Unit

- 1 Remove the Face Plate from the unit.
- 2 Mount the original mounting bracket to the unit using the supplied screws.

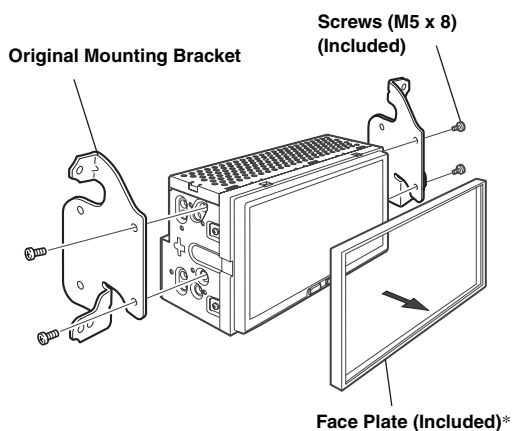

- 3 Connect all other leads of the unit according to details described in the "Connections" section (page 34).
- 4 Mounting the unit in a car.

\* Use the removed Face Plate if needed.

## Fix the Cables etc.

Fix the cables carefully. Do not damage them by tucking them into movable parts, such as a seat rail, or by locating them against sharp or pointed edges.



### Connection Diagram of SPST Switch (sold separately)

(If the ACC power supply is not available)

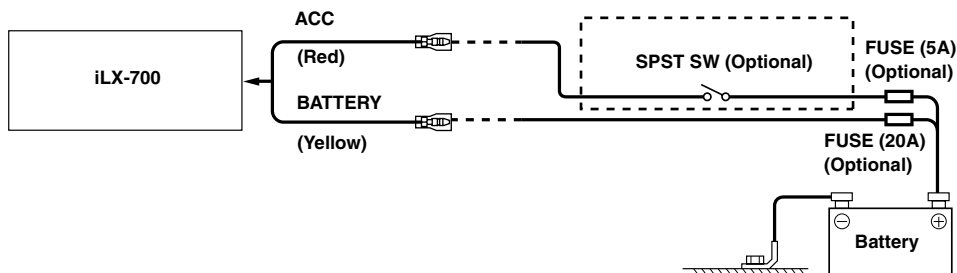

- If your vehicle has no ACC power supply, add an SPST (Single-Pole, Single-Throw) switch (sold separately) and fuse (sold separately).
- The diagram and the fuse amperage shown above are in the case when iLX-700 is used individually.
- If the switched power (ignition) lead of the iLX-700 is connected directly to the positive (+) post of the vehicle's battery, the iLX-700 draws some current (several hundred milliamperes) even when its switch is placed in the OFF position, and the battery may be discharged.

#### **To prevent external noise from entering the audio system.**

- Locate the unit and route the leads at least 10 cm away from the car harness.
- Keep the battery power leads as far away from other leads as possible.
- Connect the ground lead securely to a bare metal spot (remove any paint, dirt or grease if necessary) of the car chassis.
- If you add an optional noise suppressor, connect it as far away from the unit as possible. Your Alpine dealer carries various noise suppressors, contact them for further information.
- Your Alpine dealer knows best about noise prevention measures so consult your dealer for further information.

# Connections

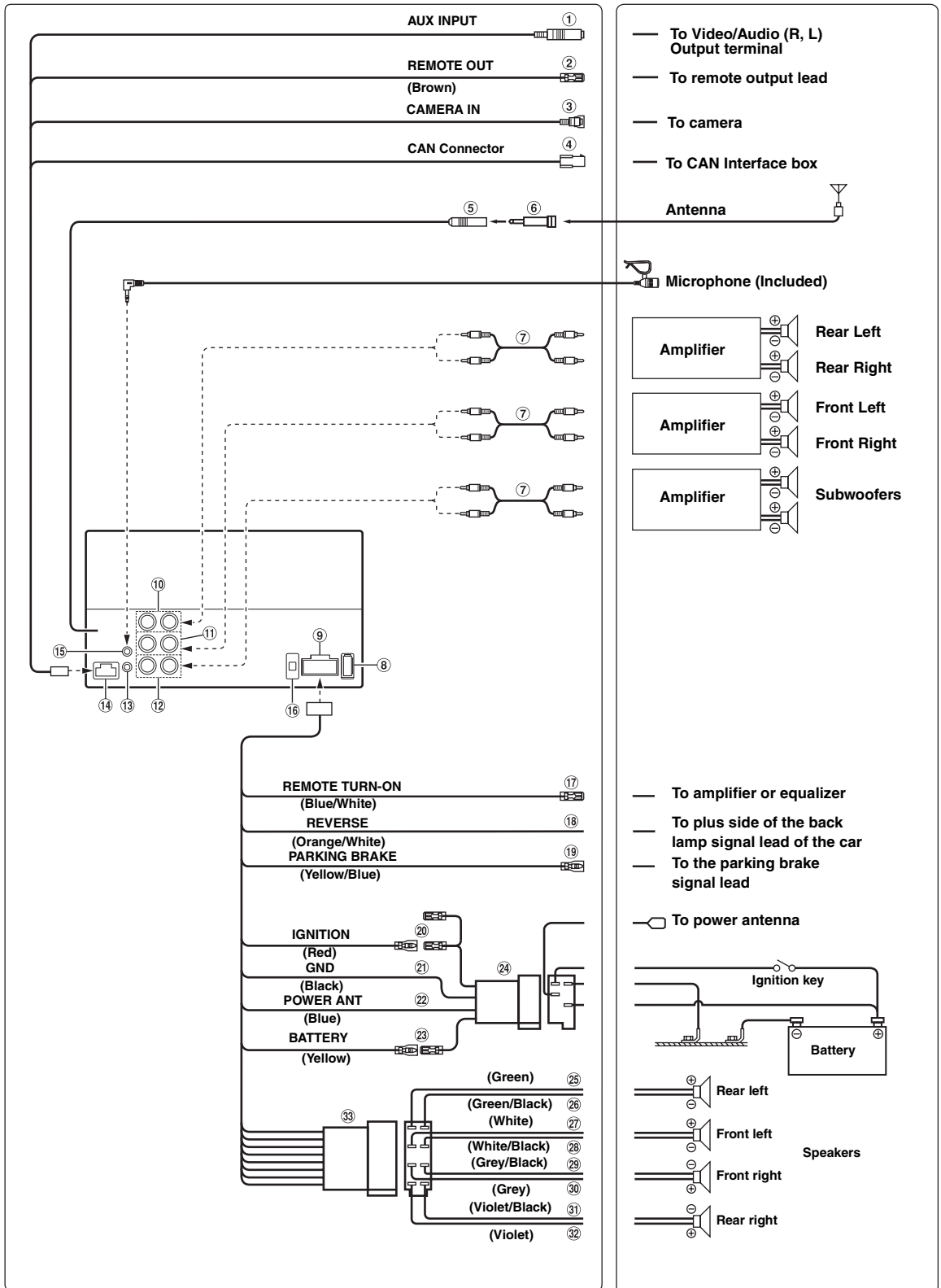

① **Video/Audio (R,L) Input Connector (AUX INPUT)**

Input the AUX Video/Audio (R,L).

- When you use this connector, an optional AV/RCA interface cable should be used.

■ **Usable AV/RCA interface cable (4-pole mini AV plug to 3-RCA)**

Wiring convention of this system is as follows:

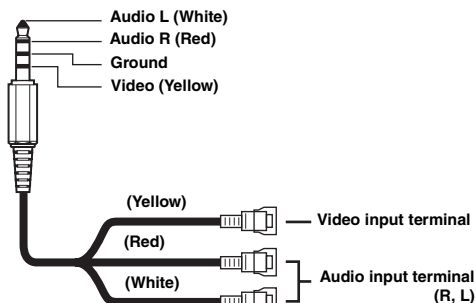

- Configuration commercially available 4-pole mini AV plugs is not standardized.

② **Remote Control Output Lead (Brown)**

Connect this lead to the remote control input lead. This lead outputs the controlling signals from the remote control.

③ **CAMERA Input Connector**

④ **CAN Interface Connector**

To CAN Interface box.

- When both CAN Interface box and Vehicle Display Interface box are connected to this unit, the operation may not be performed as normal.

⑤ **Radio Antenna Receptacle**

⑥ **ISO/JASO Antenna Adapter (sold separately)**

ISO/JASO Antenna Adapter may be required, depending on the vehicle.

⑦ **RCA Extension Cable (sold separately)**

⑧ **USB Connector**

To iPhone 5 or later.

⑨ **Power Supply Connector**

⑩ **Rear Output RCA Connectors**

It can be used as Rear Output RCA Connectors.

⑪ **Front Output RCA Connectors**

It can be used as Front Output RCA Connectors.

⑫ **Subwoofer RCA Connectors**

⑬ **Steering Remote Control Interface Connector**

To steering remote control interface box.

For details about connections, consult your nearest Alpine dealer.

⑭ **AUX/CAMERA/CAN Connector**

⑮ **MIC Input Connector**

To Microphone (Included).

⑯ **Fuse Holder (10A)**

⑰ **Remote Turn-On Lead (Blue/White)**

Connect this lead to the remote turn-on lead of your amplifier or signal processor.

⑱ **Reverse Lead (Orange/White)**

Connect to the plus side of the car's reverse lamp. This lamp illuminates when the transmission is shifted into reverse (R).

With this lead properly wired, the video picture automatically switches to the rear camera whenever the car is put into reverse (R).

⑲ **Parking Brake Lead (Yellow/Blue)**

Connect this lead to the power supply side of the parking brake switch to transmit the parking brake status signals to the iLX-700.

⑳ **Switched Power Lead (Ignition) (Red)**

Connect this lead to an open terminal on the vehicle's fuse box or another unused power source which provides (+) 12V only when the ignition is turned on or in the accessory position.

㉑ **Ground Lead (Black)**

Connect this lead to a good chassis ground on the vehicle. Make sure the connection is made to bare metal and is securely fastened using the sheet metal screw provided.

㉒ **Power Antenna Lead (Blue)**

Connect this lead to the +B terminal of your power antenna, if applicable.

- This lead should be used only for controlling the vehicle's power antenna. Do not use this lead to turn on an amplifier or a signal processor, etc.

㉓ **Battery Lead (Yellow)**

Connect this lead to the positive (+) post of the vehicle's battery.

㉔ **ISO Power Supply Connector**

㉕ **Left Rear (+) Speaker Output Lead (Green)**

㉖ **Left Rear (-) Speaker Output Lead (Green/Black)**

㉗ **Left Front (+) Speaker Output Lead (White)**

㉘ **Left Front (-) Speaker Output Lead (White/Black)**

㉙ **Right Front (-) Speaker Output Lead (Grey/Black)**

㉚ **Right Front (+) Speaker Output Lead (Grey)**

㉛ **Right Rear (-) Speaker Output Lead (Violet/Black)**

㉜ **Right Rear (+) Speaker Output Lead (Violet)**

㉝ **ISO Connector (Speaker Output)**

## System Example

### Connection of an iPhone\*

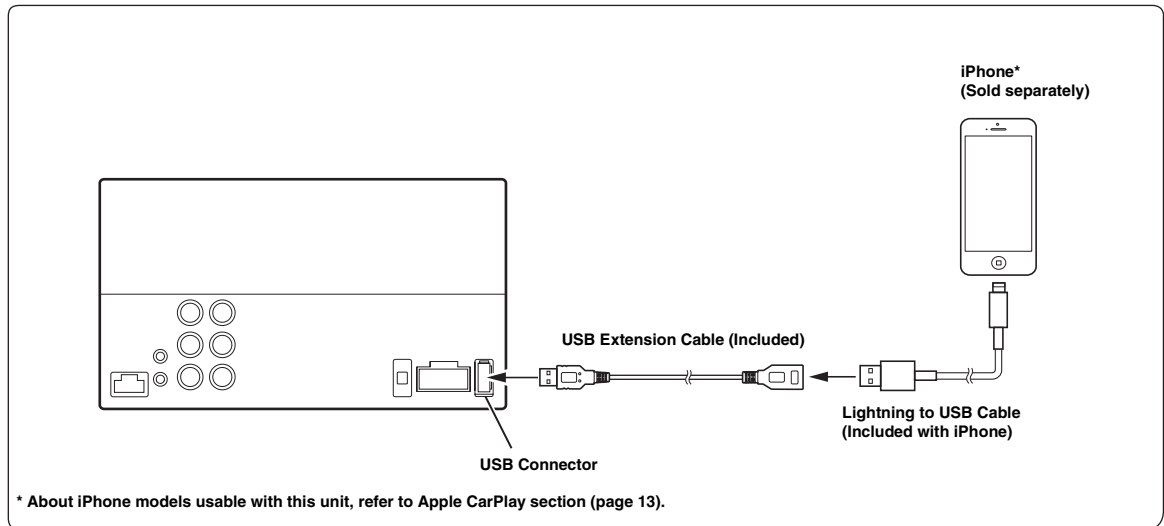

- Do not leave an iPhone in a vehicle for a long time. Heat and humidity may damage the iPhone and you may not be able to play it again.

## Connection of an External device

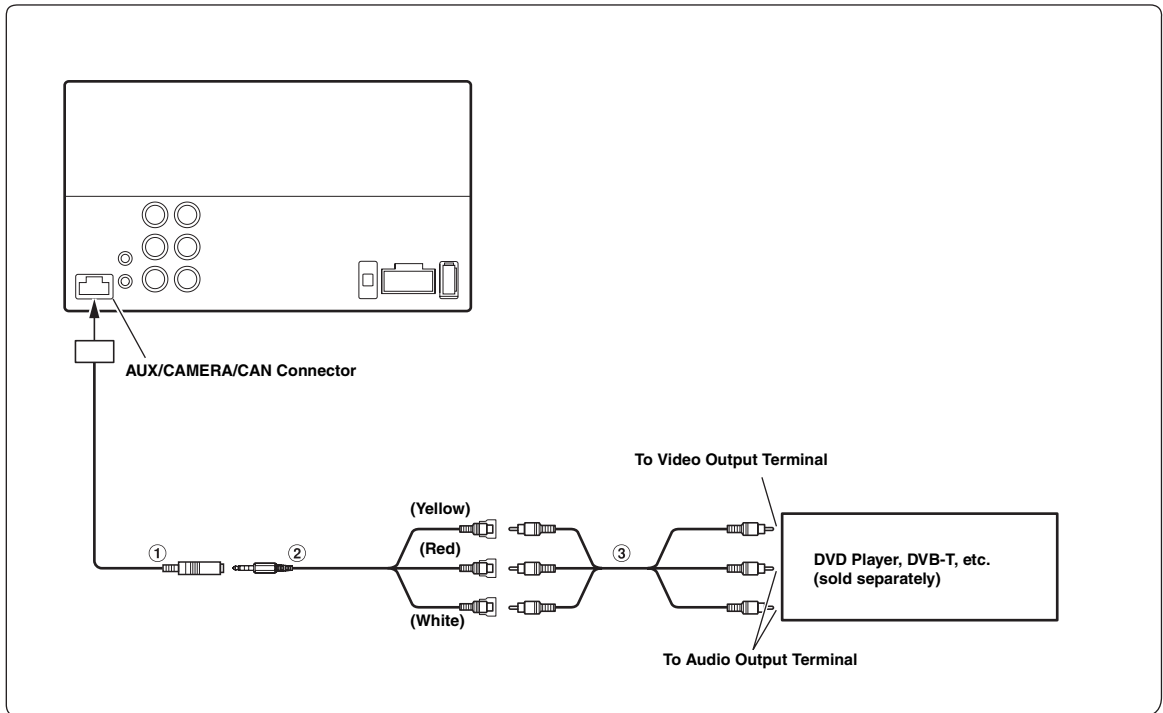

### ① Video/Audio Input Connector (AUX INPUT)

- When you use this connector, an optional AV/RCA interface cable should be used. For details, refer to ②.

### ② AV/RCA interface cable (4-pole mini AV plug to 3-RCA) (Sold Separately)

#### ■ Usable 4-pole mini AV plug

Wiring convention of this system is as follows:

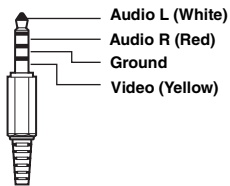

- Configuration commercially available 4-pole mini AV plugs is not unified.

### ③ RCA Extension Cable (Sold Separately)

## Connection of an External Amplifier

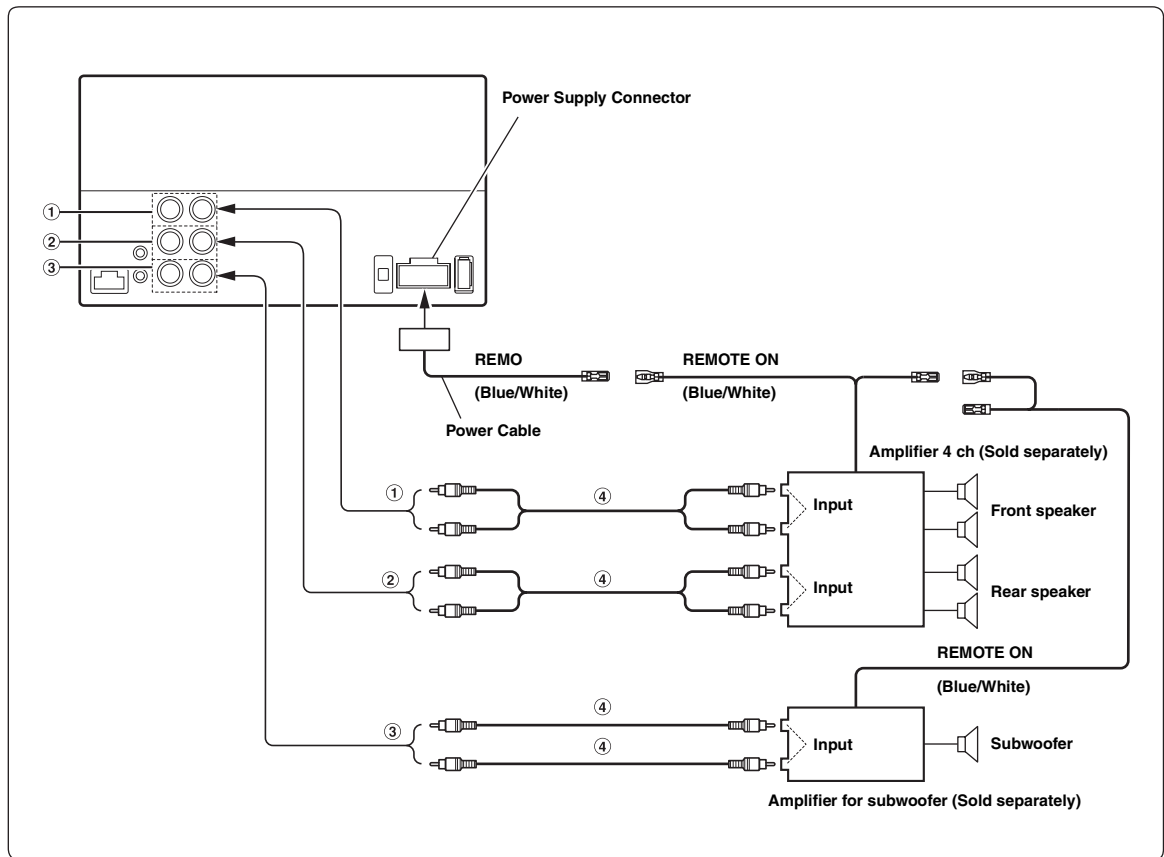

① **Front Output RCA Connectors**  
RED is right and WHITE is left.

② **Rear Output RCA Connectors**  
RED is right and WHITE is left.

③ **Subwoofer RCA Connector**

④ **RCA Extension Cable (Sold separately)**

## Connection of camera

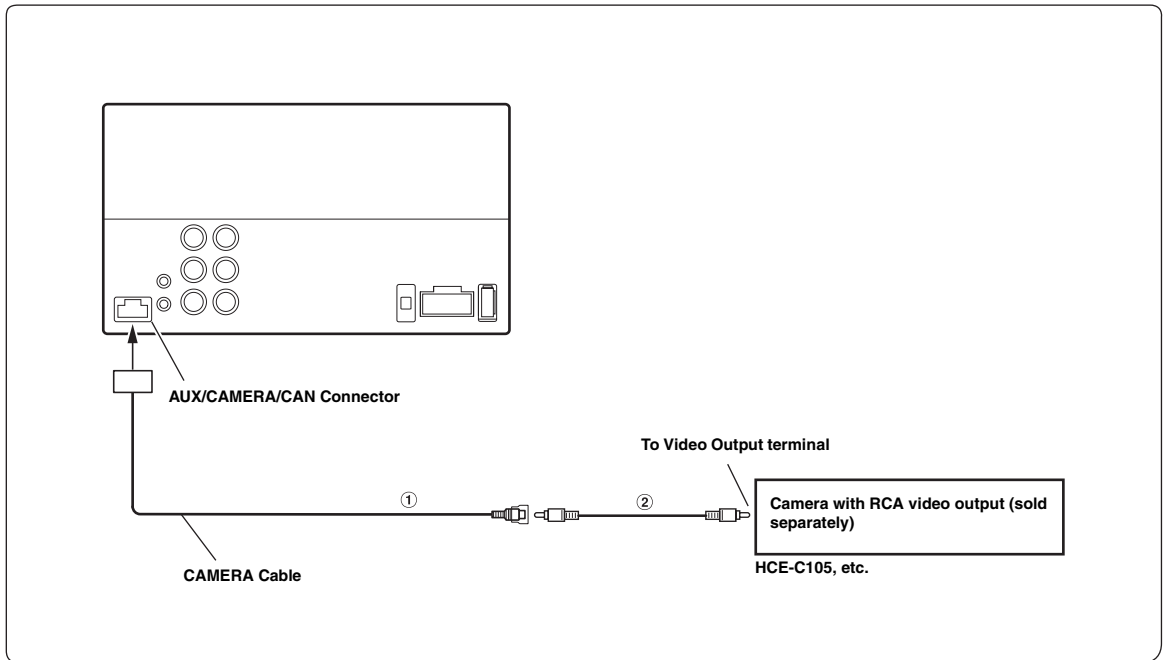

### ① CAMERA Input Connector

- When a rear camera is used, make sure REVERSE cable is connected correctly.

### ② RCA Extension Cable (sold separately)

## Connection of HCE-C200F + HCE-C200R

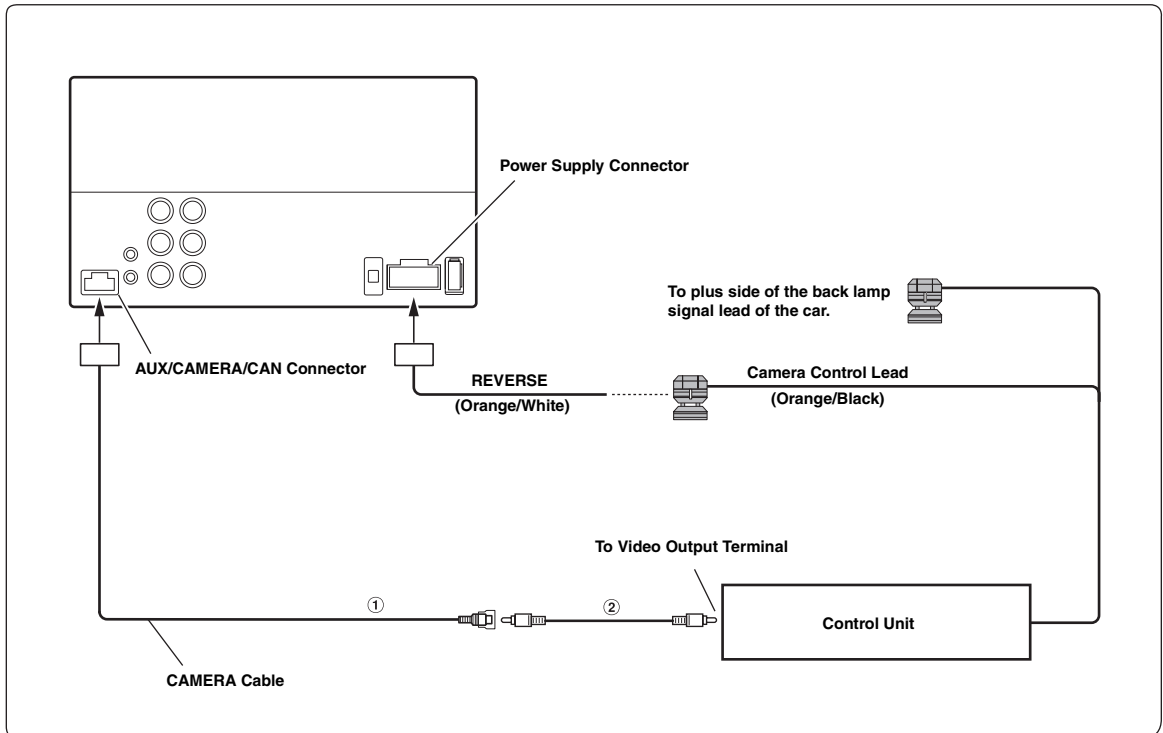

### ① CAMERA Input Connector

- When a rear camera is used, make sure REVERSE cable is connected correctly.

### ② RCA Extension Cable (HCE-C200R included)

**About the Rules of Bluetooth Electromagnetic  
Radiation Regulation**



**Declaration of Conformity**





**ALPINE ELECTRONICS, INC.**

20-1, Yoshima Industrial Park, Iwaki, Fukushima 970-1192  
Japan  
Phone: +81-246-36-4111 Fax: +81-246-36-6090

No. AJ140017

## Declaration of Conformity

We, authorized representative in Europe ,

Alpine Electronics (Europe) GmbH

Wilhelm Wagenfeld Strasse 1-3, 80807 Munich, Germany

certify and declare under our sole responsibility that the following product(s)

|                         |                                       |
|-------------------------|---------------------------------------|
| <u>Product name</u>     | <u>Display Unit</u>                   |
| <u>Manufacturer</u>     | <u>Alpine Electronics, Inc.</u>       |
| <u>Model No.</u>        | <u>iLX-700</u>                        |
| <u>Installed module</u> | <u>WLAN: AFT-RW404 (2412-2472MHz)</u> |

complies with the essential requirements and provisions of the following European Directives, based on the European standards applied:

| <u>Directives</u>            | <u>Applied Harmonized Standards</u> | <u>Test Report No.</u> |
|------------------------------|-------------------------------------|------------------------|
| <u>R&amp;TTE (1999/5/EC)</u> | <u>EN 300328 V1.8.1 (2012-06)</u>   | <u>400-140076</u>      |
|                              | <u>EN 62479: 2010</u>               | <u>400-140077</u>      |
|                              | <u>EN301489-1 V1.9.2 (2011-09)</u>  | <u>400-140078</u>      |
|                              | <u>EN301489-17 V2.2.1 (2012-09)</u> |                        |
|                              | <u>EN60950-1: 2006</u>              | <u>351-140100</u>      |
|                              | <u>A11: 2006/A1: 2010/A12: 2011</u> |                        |

The technical documentation for this product is retained at the above manufacturer's location.

|                      |  |
|----------------------|--|
| <u>Company</u>       | <u>Alpine Electronics (Europe) GmbH</u>  |
| <u>Address</u>       | <u>Wilhelm Wagenfeld Strasse 1-3, 80807 Munich, Germany</u>                                |
| <u>Phone number</u>  | <u>49(0)89-324264-240</u>  |
| <u>FAX number</u>    | <u>49(0)89-324264-241</u>  |
| <u>Manufacturer</u>  | <u>Alpine Electronics, Inc.</u>  |
| <u>Signature</u>     | <u></u> |
|                      | <u>Mitsuru Yoshida</u><br><u>Global Engineering Strategy Office</u>                        |
| <u>Date of issue</u> | <u>4-Sep-14</u>  |