

Uponor

RADIANT HEATING SYSTEMS
SETPOINT 501 AND 501s
CONTROLLERS

INSTALLATION AND
OPERATION MANUAL

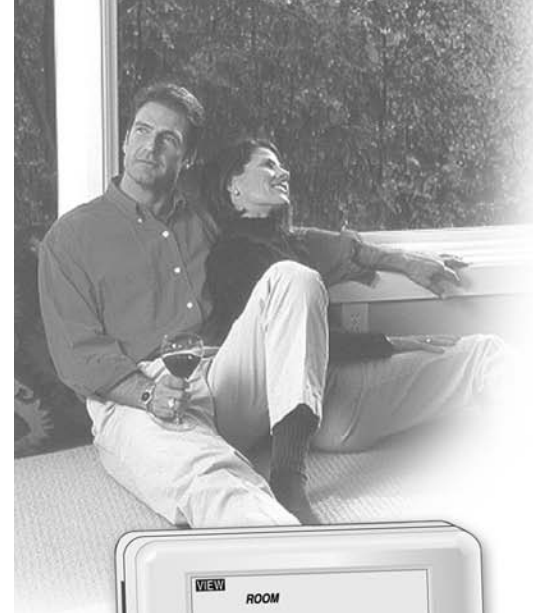

hvacUSA.com

A MechTronics Controls Company

www.hvacusa.com

Phone (877) 632-4876

Uponor, Inc.

5925 148th Street West
Apple Valley, MN 55124
Tel: (800) 321-4739
Fax: (952) 891-1409

Web: www.uponor-usa.com

E-mail: learnmore@uponor-usa.com

Uponor Ltd.

655 Park Street
Regina, SK S4N 5N1
Tel: (888) 994-7726
Fax: (800) 638-9517

Web: www.uponor.ca

E-mail: info@uponor.ca

uponor

SetPoint 501 and 501s Controllers
Installation and Operation Manual

Table of Contents

Section 1 — Introduction	1
Section 2 — Installation	
Getting Ready	3
Removing the Front Cover	3
Mounting the Base	3
Rough-in Wiring	4
Wiring the Controller	4
Installing the Front Cover	4
Wiring Examples	5
Display and Keypad Operation	6
Cycles per Hour	6
Optional Sensors	7
Access Levels	7
Sequence of Operation	8
Mode	8
Section 3 — Navigating the Menus	
View Menu	9
Adjust Menu	9
Section 4 — Troubleshooting	
Error Messages	11
Section 5 — Technical Data	
SetPoint 501	13
SetPoint 501s	14

SetPoint 501 and 501s Controllers Installation and Operation Manual

Published by Uponor, Inc.
5925 148th Street West
Apple Valley, MN 55124
(800) 321-4739

www.uponor-usa.com

© 2007 Uponor, Inc.
All rights reserved

Third Edition, March 2007
First Printing, November 2002
Printed in the United States of America

Section 1 Introduction

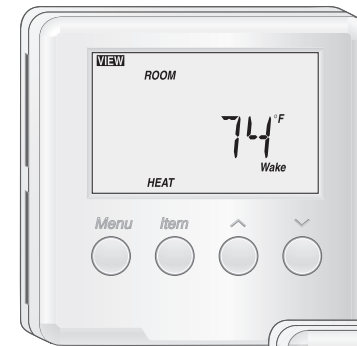

SetPoint 501

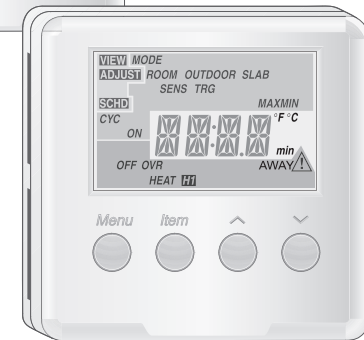

SetPoint 501s

The SetPoint 501 and 501s Controllers are microprocessor-based controls that are designed to sense the air temperature in a specific area and increase the comfort level of that area as well as increase the energy efficiency of the heating system. The 501s will also monitor slab temperature.

Section 2

Installation

Getting Ready

Check the contents of this package. If any contents listed below are missing or damaged, please contact your Uponor sales representative or distributor for assistance.

- SetPoint 501 (part number A3040501) includes one controller, an Installation and Operation Manual and a User Manual.
- SetPoint 501s (part number A3041501) includes one programmable Setpoint Controller, one Floor Sensor (part number A3040079), an Installation and Operation Manual and a User Manual.

Removing the Front Cover

1. Place a screwdriver or similar object into the small slot located in the top of the controller.
2. Push the screwdriver against the plastic tab and pull the top of the front cover so that it pivots around the bottom edge of the base. (See **Figure 1.**)

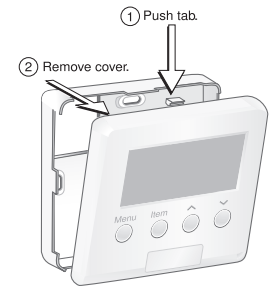

Figure 1:
Removing the Front Cover

Mounting the Base

1. Install the controller on an interior wall of the desired zone approximately 5 feet (1.5m) above the floor.

Note: Do not mount the controller in a location that may be affected by localized heat sources or cold drafts.

2. If necessary, install a draft barrier behind the controller to prevent air from blowing through the wiring hole and affecting the controller's built-in sensor.
3. Mount the base directly to the wall using two #6 1-inch screws. (See **Figure 2.**)
4. Insert the screws through the mounting holes, and fasten the base securely to the wall. If possible, at least one of the screws should enter a wall stud or similar surface.

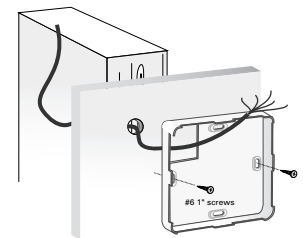

Figure 2:
Mounting the Base

- If the controller is mounted to a 2x4 electrical box, order a Cover Plate for the 500 Series Controllers (part number A3040007). This plate mounts to the electrical box and the controller mounts to the plate. Ensure that the electrical box does not provide cold air to the controller.

Note: If the SetPoint 501s is used for remote sensing (i.e., the built-in air sensor is disabled and an indoor sensor is used), mount the controller in the desired location.

Rough-in Wiring

Note: 18 AWG or similar wire is recommended for all 24VAC wiring.

- Strip all wires to ¼" (6mm) to ensure proper connection to the control.
- Run wires from the 24VAC power to the controller. Use a clean power source to ensure proper operation.
- If using an optional sensor, install the sensor according to the appropriate instruction sheet and run two wires from the sensor to the controller.
- Run wires from the heating device to the controller.

Wiring the Controller

Refer to the wiring examples on **page 5** to properly wire the controller.

- Connect the 24VAC power to the R and C terminals on the controller. This connection provides power to the microprocessor and display of the controller.
- When wiring an optional sensor to the SetPoint 501s, connect the two wires from the sensor to the Com and S1 terminals.

Note: The Heat terminals are isolated outputs. There is no power available on these terminals from the controller. Use these terminals as a switch for a 24VAC circuit. This circuit can operate a low-current, 24VAC device directly or an external relay to enable a line-voltage or high-current device.

Installing the Front Cover

- Align the hinges on the bottom of the front cover with the bottom of the controller mounting base.
- Pivot the front cover around the bottom hinges and push the top against the mounting base until it snaps firmly in place. (See **Figure 3**.)

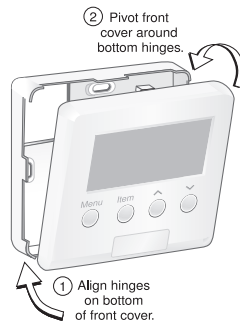

Figure 3:
Installing the Front Cover

Wiring Examples for the SetPoint 501 and SetPoint 501s

Refer to the figures below to wire 24VAC power and the optional sensor.

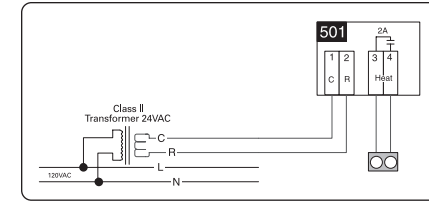

Figure 4: Wiring the SetPoint 501

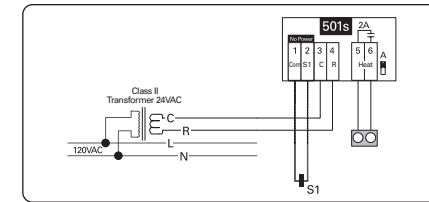

Figure 5: Wiring the SetPoint 501s

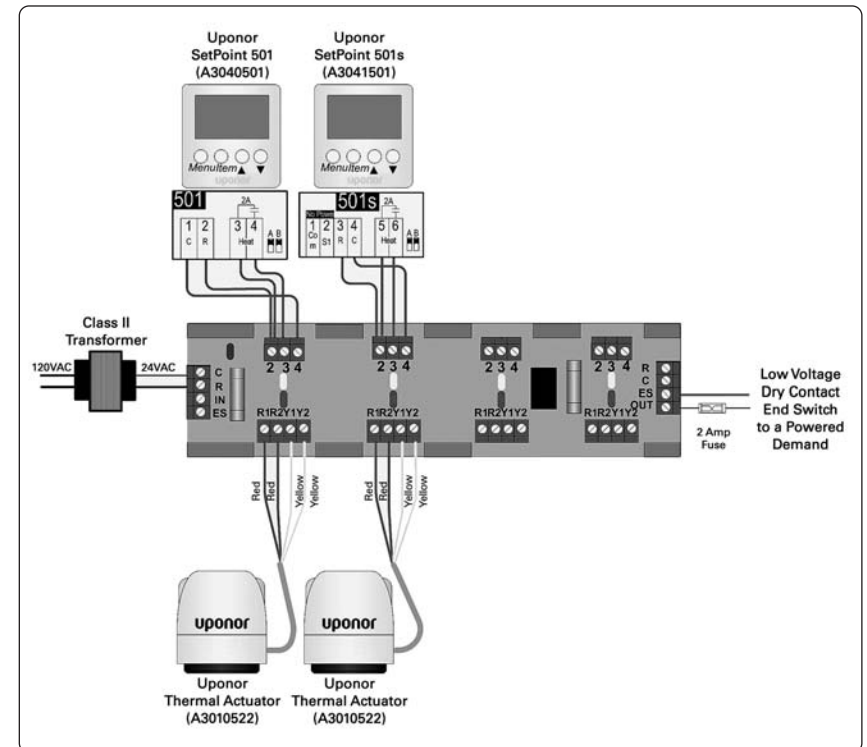

Figure 6: Wiring the Zone Control Module (ZCM)

Display and Keypad Operation

The SetPoint 501 and 501s Controllers feature four fields: Menu, Item, Number and Status. (See **Figure 7.**)

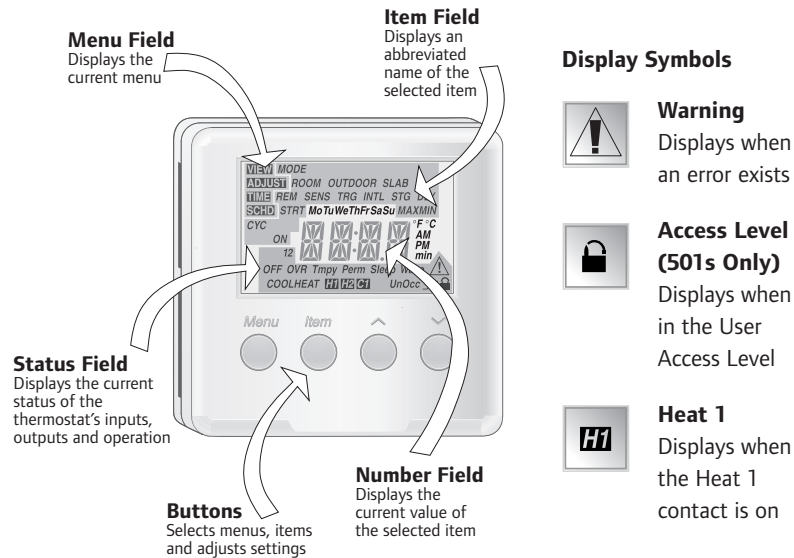

Figure 7: Wiring the Zone Control Module (ZCM)

Cycles per Hour

The SetPoint 501 and 501s controllers operate on cycles per hour. The number of cycles per hour is adjustable through the Heat Cycle setting in the Adjust menu. During each cycle that heating is required, the controller turns on the Heat relay for a calculated amount of time. This amount of time is called the on time. The on time is calculated based on the requirements of the zone. If the zone requires more heating, the appropriate on time is increased. If the zone requires less heating, the appropriate on time is reduced. (See **Figure 8.**)

The controller ensures the relay remains on or off for a minimum amount of time to prevent short cycling.

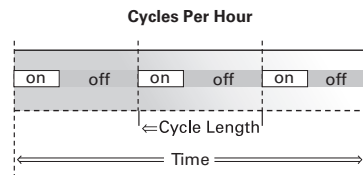

Figure 8: Cycles per Hour

An Auto Cycle setting is available for the heating cycle. This setting determines the optimum number of cycles per hour to balance temperature swings and equipment cycles.

Optional Sensors (501s Only)

Each controller has a single built-in sensor to measure air temperature. In addition to this built-in sensor, the SetPoint 501s features terminals to connect one additional sensor (i.e., indoor sensor, outdoor sensor, slab or floor sensor or sensor placed in a remote location).

Indoor Sensor

An indoor sensor measures the air temperature in the zone that the SetPoint is controlling. The temperature measured by the outdoor sensor is used in the on-time calculations for the relay in the controller. Select this setting on the Adjust menu. If the built-in sensor is on and the auxiliary sensor is set to Indoor, the temperatures of the sensors are averaged and used to calculate the on time of the relay.

Outdoor Sensor

An outdoor sensor measures the temperature of the air outside. The temperature measured by the outdoor sensor does not affect the on time of the relay and is only used for display purposes.

Slab or Floor Sensor

A slab or floor sensor measures the slab or floor temperature in the zone that the controller is controlling. The temperature the slab or floor sensor reads is used in the on-time calculations for the Heat relay and allows the controller to operate the slab between the minimum and maximum slab settings.

Access Levels (501s Only)

The SetPoint 501s features two access levels — User and Installer — which restrict the number of items available in the display menus. Change the access level via the DIP switch located on the circuit board inside the controller. (See **Figure 9.**)

The Installer access level allows the installer to adjust all the settings in the controller including those required to match the controller to the mechanical system and devices. The User access level allows the end user to adjust the temperature settings.

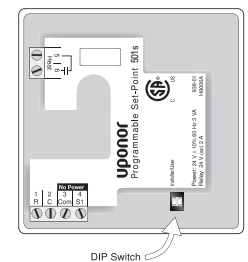

Figure 9: DIP Switch Location

Sequence of Operation

Air Sensor Only Operation

When operating with only an air sensor, the on time for the Heat relay is calculated to satisfy the requirements of the air sensor.

Slab or Floor Sensor Only Operation (501s Only)

When operating with only a slab or floor sensor, the on time for the Heat relay is calculated to satisfy the requirements of the slab or floor sensor. The controller operates to maintain the slab at the minimum slab temperature setting.

Note: Using only a slab or floor sensor may cause overheating or underheating of the space.

Air and Slab or Floor Sensor Operation (501s Only)

When operating with both air and slab or floor sensors, the controller calculates an on time for the Heat relay to satisfy the slab or floor sensor's requirements and an on time to satisfy the air sensor's requirements. The Heat relay operates for the longer of these two on times.

During light heating loads, overheating can occur due to the minimum slab or floor temperature requirements.

During heavy heating loads, the maximum slab or floor temperature setting limits the on time of the Heat relay. In this situation, underheating can occur.

Mode

Heat

In the heat mode, the Heat relay satisfies the temperature requirement of the zone.

Off

The Heat relay does not operate in the Off mode.

Note: If an air, slab or floor sensor is active in the Off mode, a freeze-protection function enables, allowing the Heat relay to operate and keep the zone above 35°F (2°C).

Section 3

Navigating the Menus

View Menu

ROOM TARGET

This displays the current desired air temperature for the space (one active air sensor required). This is only available when in the Installer access level. (See **Figure 10**.)

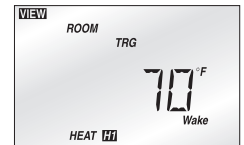

Figure 10

ROOM

This displays the current air temperature for the space that is the average of all active air sensors (one active air sensor required). (See **Figure 11**.)

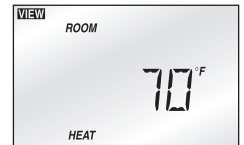

Figure 11

OUTDOOR (501s Only)

This displays the current temperature at the outdoor sensor. An outdoor sensor must be installed for this menu to function. (See **Figure 12**.)



Figure 12

SLAB (501s Only)

This displays the current slab or floor temperature (one active air sensor required). If two slab or floor sensors are present, this is the average temperature. MIN is displayed when the slab or floor minimum temperature is calling for heat. The slab or floor sensor may call for heat even though the room setpoint temperature is satisfied. (See **Figure 13**.)

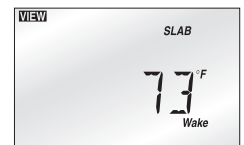

Figure 13

Adjust Menu

MODE

This displays the current mode of operation of the thermostat. (See **Figure 14**.)

OFF, HEAT

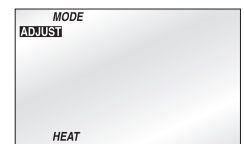

Figure 14

ROOM HEAT

This displays the desired temperature for heating (must set active air sensor to Heat or Auto).

(See **Figure 15**.)

35 to 100°F (2 to 38°C)



Figure 15

SLAB MIN (501s Only)

This displays the minimum slab or floor temperature (one active slab sensor required).

(See **Figure 16**.)

OFF, 34 to 122°F (OFF, 1 to 50°C)



Figure 16

SLAB MAX (501s Only)

This displays the maximum slab or floor temperature (one active air sensor required).

This is only available when in the Installer access level. (See **Figure 17**.)

34 to 122°F, OFF (1 to 50°C, OFF)



Figure 17

SENS (501s Only)

This selects the type of optional sensor present (only available in the Installer access level).

(See **Figure 18**.)

OFF, Indr, SLAB, OUT



Figure 18

ROOM SENS (501s Only)

This enables or disables the built-in sensor (only available in the Installer access level).

(See **Figure 19**.)

OFF, ON



Figure 19

CYC HEAT (501s Only)

This displays the number of cycles per hour for heating (only available in the Installer access level). (See **Figure 20**.)

AUTO, 2 to 12

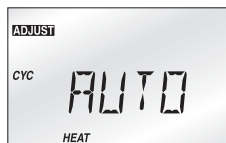

Figure 20

UNITS

This displays the units of temperature used.

(See **Figure 21**.)

°F, °C



Figure 21

Section 4

Troubleshooting

Error Messages

E01

The controller was unable to read a piece of information stored in its memory and was required to load the factory settings. The controller will stop operation until all settings are checked. To clear this error, select the Installer access level and check all of the settings in the Adjust menu. (See **Figure 22**.)



Figure 22

E02

There are no active sensors selected on the controller. Either turn on the internal sensor or set the auxiliary sensor to INDR or SLAB. After correcting the fault, press any button to clear the error message. (See **Figure 23**.)



Figure 23

ROOM Shr

The controller's internal air sensor has a short circuit. This error cannot be repaired in the field. Replace or return the controller for repair. (See **Figure 24**.)



Figure 24

ROOM OPN

The controller's internal air sensor has an open circuit. This cannot be repaired in the field. Either turn off the internal sensor and set an auxiliary sensor to INDR, or replace the controller and return the faulty controller for repair. After correcting the fault, press any button to clear the error message. (See **Figure 25**.)



Figure 25

SENS Shr

The optional sensor has a short circuit. Locate and repair the problem as described in the appropriate sensor instruction sheet. After correcting the fault, press any button to clear the error message. (See **Figure 26.**)

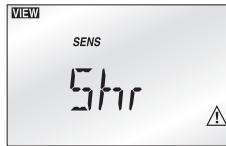

Figure 26

SENS OPN

The optional sensor has an open circuit. Locate and repair the problem as described in the appropriate sensor instruction sheet. After correcting the fault, press any button to clear the error message. (See **Figure 27.**)



Figure 27

Section 5

Technical Data

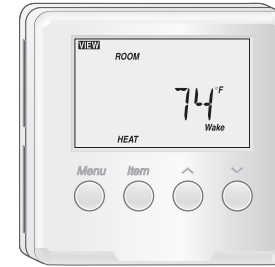

Figure 28: SetPoint 501

SetPoint 501

Literature	SetPoint 501 and 501s Controllers Installation and Operation Manual
Control	Microprocessor PI control; This is not a safety (limit) control.
Packaged Weight	0.46 lb. (210 g), Enclosure J, white PVC plastic
Dimensions	2 7/8" H x 2 7/8" W x 1 3/16" D (73 x 73 x 21mm)
Approvals	CSA C US, meets ICES and FCC regulations for EMI/RFI
Ambient Conditions	Indoor use only, -22 to 131 °F (-30 to 55 °C), <90% RH non-condensing
Power Supply	24VAC ±10% 50/60 Hz 1 VA
Relay	24VAC, 2 A



Figure 29: SetPoint 501s

SetPoint 501s

Literature	SetPoint 501 and 501s Controllers Installation and Operation Manual
Control	Microprocessor PI control; This is not a safety (limit) control.
Packaged Weight	0.54 lb. (245 g), Enclosure J, white PVC plastic
Dimensions	2 7/8" H x 2 7/8" W x 13/16" D (73 x 73 x 21mm)
Approvals	CSA C US, meets ICES and FCC regulations for EMI/RFI
Ambient Conditions	Indoor use only, -22 to 131°F (-30 to 55°C), < 90% RH non-condensing
Adjustment Range for Slab or Floor Setting	34 to 122°F (1 to 50°C)
Power Supply	24VAC ±10% 50/60 Hz 1.5 VA
Relay	24VAC, 2 A
Sensors	NTC thermistor, 10 kΩ @ 77°F (25°C ±0.2°C) β=3892
Included	Floor Sensor (A3040079)
Optional	Outdoor Sensor (A3060070), Universal Sensor (A3060071) and Epoxy-coated Slab Sensor (A3060072)