Itona TC4xyy

Hardware User's Guide



VXL Instruments Ltd,
NO.17, House of Excellence,
Electronics City,
Hosur Road,
Bangalore – 560 100, INDIA
www.vxl.net

Copyright and Trademark notices

ALL RIGHTS RESERVED.

Information in this document is subject to change without notice and does not represent a commitment on the part of the manufacturer. No part of this guide may be reproduced or transmitted in any form or means, electronic or mechanical, including photocopying and recording, for any purpose, without the express written permission of the manufacturer.

Every effort has been made to make this guide as complete and as accurate as possible, but no warranty or fitness is implied. The authors and the publisher shall have neither responsibility nor liability to any person or entity with respect to loss or damages arising from the use of information contained in this guide. This disclaimer does not apply in countries where such provisions are inconsistent with local law.

All Trademarks are acknowledged.

Document Number: 600 0101 855 28 A02

First Edition: November 2006

Federal Communication Commission (FCC) Statement

This equipment has been tested and found to comply with the limits for a Class B digital device, pursuant to Part 15 of the FCC Rules. These limits are designed to provide reasonable protection against harmful interference in a residential installation. This equipment generates uses and can radiate radio frequency energy and, if not installed and used in accordance with the instructions, may cause harmful interference to radio communications. However there is no guarantee that interference will not occur in a particular installation.

If this equipment does cause harmful interference to radio or television reception, which can be determined by turning the equipment Off and On, the user is encouraged to try to correct the interference by one or more of the following measures:

- Re-orient or relocate the receiving antenna.
- Increase the separation between the equipment and receiver.
- Connect the equipment to an outlet on a circuit different from that to which the receiver is connected.
- Consult the dealer or an experienced radio / television technician for help.

Each Thin Client is equipped with a FCC compliance label that shows only the FCC identification number. The full information of the associated label is as follows:

This device complies with Part 15 of the FCC rules. Operation is subject to the following two conditions:

1. This device may not cause harmful interference, and
2. This device must accept any interference received, including interference that may cause undesired operation.

Warning

- DO NOT open enclosure, Hazard voltages present inside equipment.
- Ensure that all expansion slots (on the back or side of the computer) are covered with metal retaining brackets, and tightly attached to the computer cabinet.
- Only equipment certified to comply with Class B (computer input/output devices, terminals, printer's etc.) should be attached to this equipment, and must have shielded interface cables.
- Any changes or modifications not expressly approved by the party responsible for compliance could void the user's authority to operate this equipment.
- This equipment should not be used in Electro-medical applications.
- There are no user serviceable parts inside. DO NOT open enclosure, Hazard voltages present inside equipment. DO NOT disassemble the equipment as this can nullify your warranty
- DO NOT operate this equipment in corrosive or explosive atmosphere.
- DO NOT operate this equipment outside specified temperature limits.
- This equipment must be earthed.
- The AC socket outlet shall be installed near the equipment and shall be easily accessible.
- Sound Power Level is less than 60dB (A), when measured according to ISO 7779.

Preface

Thank you for purchasing the Itona TC4xyy Series Thin Client. This guide contains information to setup and use the hardware of Itona TC4xyy Series.

The guide consists of the following chapters:

- **Introduction:** provides an overview of the product.
- **Installation:** contains the procedure to setup the hardware.
- **Specifications:** provides hardware, mechanical, electrical, interface and operating environment specifications.
- **Connectors and Cables:** provides detailed specifications for connectors and cables used with the product.
- **Troubleshooting:** provides solutions to problems that you may encounter while using the product.

Table of Contents

| | |
|---|----|
| Introduction | 6 |
| Overview..... | 6 |
| Features | 7 |
| Optional Features | 7 |
| Installation..... | 8 |
| Step One: Unpack | 8 |
| Step Two: Prepare..... | 8 |
| Step Three: Connect accessories and power | 9 |
| Step Four: Connect to the Server..... | 11 |
| LAN connection through TCP/IP | 11 |
| Direct Connection through RS232 | 12 |
| Dial-In Remote Connection through a Modem..... | 12 |
| Specifications..... | 13 |
| Hardware | 13 |
| Mechanical | 13 |
| Environmental Operating..... | 13 |
| Electrical | 13 |
| Connectors and Cables | 14 |
| Connectors | 14 |
| COM Port..... | 14 |
| Printer Port (Parallel)..... | 14 |
| 10/100 LAN Port..... | 15 |
| Video Port..... | 15 |
| Mouse / Keyboard Port..... | 15 |
| Audio / Microphone Port..... | 15 |
| USB Port..... | 15 |
| Cables | 16 |
| 10/100 LAN Cable | 16 |
| COM Port (Serial Port) Cables..... | 16 |
| Printer Cable..... | 17 |
| Troubleshooting..... | 18 |

Introduction

Overview

Thin Clients are essentially terminal devices that connect to multi-user application servers operating under Citrix MetaFrame and Windows 2000/ 2003 operating systems.

This guide covers installation and hardware details of Itona TC4xyy Series.



Itona TC4xyy
TC43/44yy



Itona TC4xyy
TC45/46yy

Itona TC4xyy Series deliver smart and robust solutions for Thin Client computing. They are aesthetically and ergonomically designed compact desktop, providing simultaneous full screen connectivity to Windows and UNIX application servers – a powerful business alternative to users using Win32 applications while continuing access to legacy UNIX applications.

They communicate with application servers via the ICA protocol developed by Citrix Systems Inc., Remote Desktop Protocol from Microsoft and a host of other popular connectivity protocols. Please refer to the Software User's Guide for information about connection protocols supported by your model.

Features

The product is equipped with a 10/100 Ethernet port that gives an instant connection to a multi-user Windows NT application server. Also provided are serial, parallel and video display ports. USB and PS/2 compatible keyboard/Mouse ports are available for quick setup and use.

Optional Features

- Smart Card reader
- Wireless LAN

Note: The optional features cannot be upgraded in the field. Please contact the reseller or dealer from whom you purchased the product for information about optional features.

Installation

This chapter describes hardware installation of the product.

Step One: Unpack

Unpack the unit taking care not to drop the product whilst removing from the packaging. The carton in which the product was shipped to you contains the following:

- Itona TC4xyy Series Thin Client
- Pedestal Set
- Power Cord (Optional)
- Mouse (Optional)
- Hardware Installation Guide

When you open the carton, if you find any discrepancy between the contents of the carton and the above list, contact the dealer or reseller from whom you have purchased the product, immediately.



NOTE: PLEASE RETAIN THE ORIGINAL CARTON AND PACKING MATERIAL. THEY WOULD BE REQUIRED TO AVOID DAMAGE DURING TRANSIT (IF REQUIRED IN FUTURE).

Step Two: Prepare

1. The site where you want to install the product must have the following
2.
 - 100~240V AC, 1.2A, 50/60 Hz, 3-pin power Inlet for client (Itona TC4xyy).



NOTE: ENSURE THAT THE POWER INLET PLUG IS PROPERLY REGULATED AND EARTHED. A FLOATING GROUND / CHASSIS COULD CAUSE AN ELECTRIC SHOCK.

- Fix the pedestals at the bottom of the Itona TC4xyy.
 - Well ventilated, clean, dry and dust free atmosphere
 - Specified environmental conditions (refer to the section on specifications)
 - Table or desk of suitable size.
3. Place the product on the table in a location that provides quick and easy access to the power Inlet plug to shutdown the power in emergencies.
 4. Ensure a minimum space of 2 inches (5 cm) on all sides of the unit for efficient convection cooling.

Step Three: Connect accessories and power







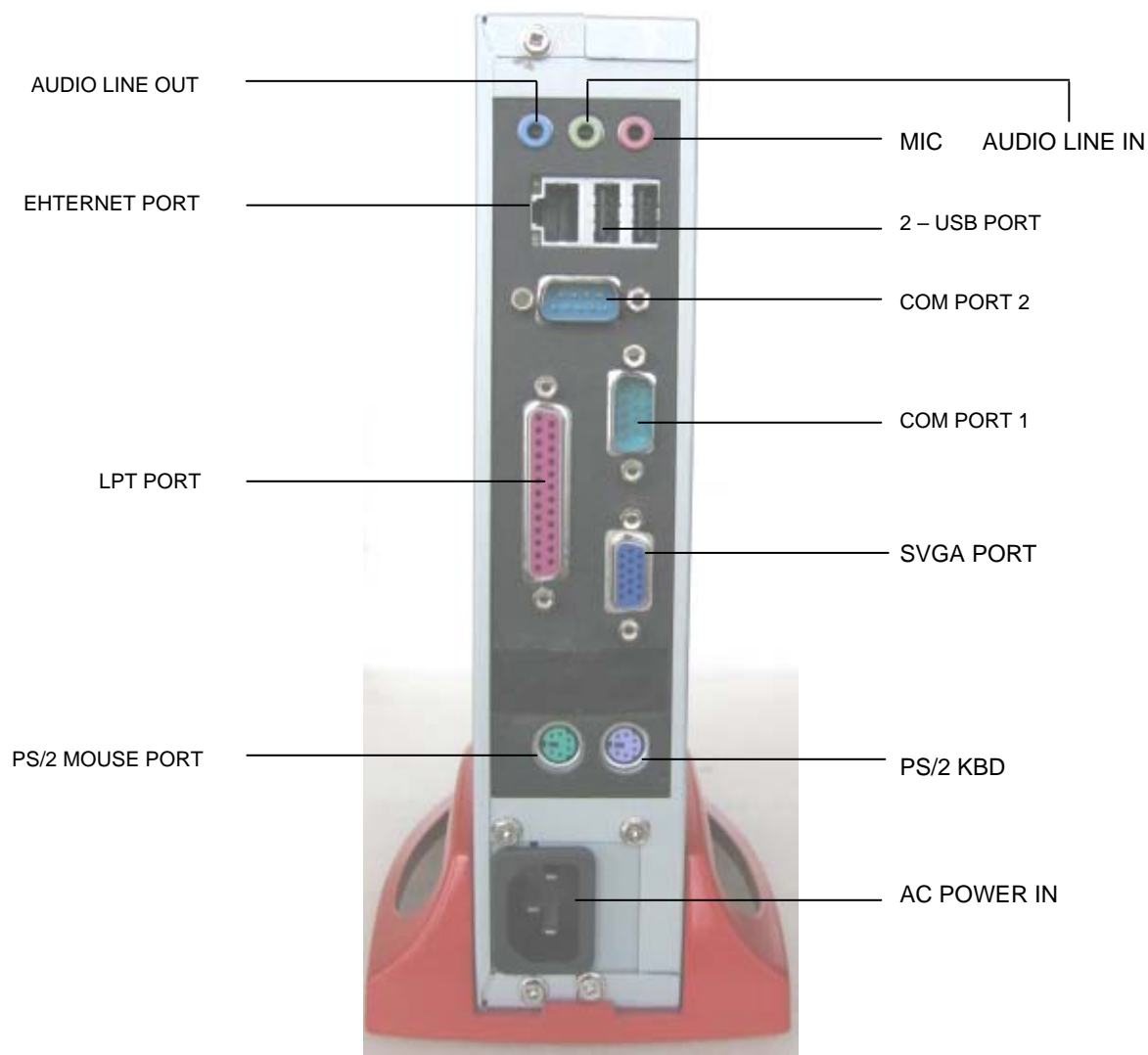



NOTE: BEFORE CONNECTING ANY CABLES, ENSURE POWER CABLE IS UNPLUGGED FROM THE UNIT. PLEASE USE 6A (MIN) / 250V AC 0.75 sq mm, H05VV-F CERTIFIED POWER CORD.

Pictures below show the various connectors available on the rear panel of the client.



Itona TC4xyy
Rear view

The table below identifies the devices to be used with each connector of the client.

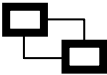
| Instructions to connect various accessories | Connector Symbol |
|---|---|
| ✓ Connect the video cable from your display unit to the video port |  |
| ✓ Connect USB devices to the USB ports |  |
| ✓ Connect external powered speakers to the audio output(LINE OUT) port |  |
| ✓ Connect an external audio device to the Microphone(LINE IN) input port |  |
| ✓ Connect microphone to the Microphone input port |  |
| ✓ Connect PS/2 keyboard to the PS/2 Keyboard port |  |
| ✓ Connect PS/2 mouse to the PS/2 Mouse port |  |
| ✓ Connect serial devices to the COM ports |  |
| ✓ Connect parallel printer to the parallel port |  |
| ✓ Connect LAN cable to the RJ45 Ethernet port |  |

Caution: Ensure that COM1, COM2, Video and Parallel ports are adequately fastened with the screws provided with the cables.

Step Four: Connect to the Server

The Thin Client can be physically connected to the server/network in three ways:

- LAN connection through TCP/IP
- Direct connection through RS232
- Dial-in remote connection through a modem

LAN connection through TCP/IP

Connect one end of a 10/100 cable to the LAN port of the client. Connect the other end to a LAN hub as shown in the figure below.

LAN Connection through TCP/IP

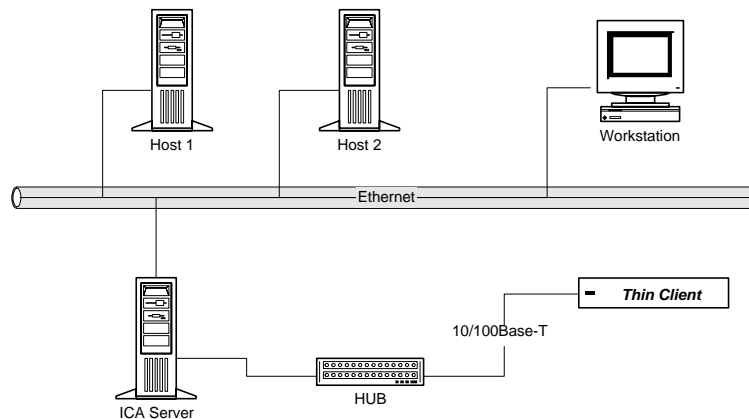

Direct Connection through RS232

Connect one end of an RS232 cross cable to a serial port of the client. Connect the other end to a serial port of the server as shown in the figure below.



Direct Connection through RS232

Dial-In Remote Connection through a Modem

Connect one end of an RS232 straight cable to a serial port of the client. Connect the other end to a modem as shown in the figure below.

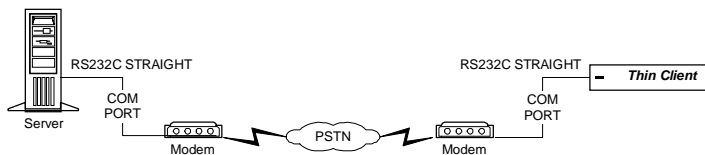

Dial-In Remote Connection through Modem

Press the power button to power up the Itona TC4xyy. The front panel LED lights up and the client boots up with a BEEP sound and takes you to the Connection Manager screen. Refer to the *Software User's Guide* for configuring the client.

Specifications

Hardware

- Processor: VIA C7™ nanoBGA2 1GHz
- VGA Memory: Shared Video Memory 64MB max
- Flash : IDE 40 pin
- RAM: 128MB ~ 1GB DDRII 400/533MHz
- Smart Card reader (optional)
- Slim HDD (optional)
- Wireless LAN (optional)

Mechanical

| | <u>Itona TC4xyy</u> | <u>Itona TC4xyy</u> |
|-----------|---------------------|---------------------|
| | TC43yy | TC45yy |
| | TC44yy | TC46yy |
| • Height: | 228 mm. | 228 mm |
| • Width: | 50 mm. | 50mm |
| • Depth: | 230 mm. | 230 mm |
| • Weight: | 3.0 Kg (max) | 3.0 Kg(max) |

Environmental Operating

- Temperature : + 5°C to +40°C
- Storage temperature: - 20°C to +65°C
- Humidity: 20% to 80% RH non-condensing

Electrical

- Line Voltage: 100V to 240V AC (+6, -10%)
- Line Frequency: 50 / 60 Hz
- Power: 34W max
- Power Inlet: 1.2A, 3-pin power plug (IEC 320)

Connectors and Cables

Connectors

The following tables provide pin details for various connectors on the rear panel of the client.

COM Port

9-pin D-type male connector. RS232C compatible, operating at 115.2K baud maximum

| Pin | Signal | Description |
|-----|--------|---------------------|
| 1 | DCD | Data Carrier Detect |
| 2 | RxD | Receive Data |
| 3 | TxD | Transmit Data |
| 4 | DTR | Data Terminal Ready |
| 5 | GND | Signal Ground |
| 6 | DSR | Data Set Ready |
| 7 | RTS | Request To Send |
| 8 | CTS | Clear To Send |
| 9 | NC | Not Connected |

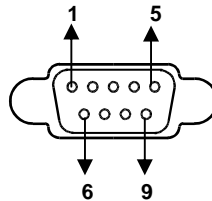

Printer Port (Parallel)

25-pin D-type female connector. ECP/EPP compatible.

| Pin | Signal |
|---------|-------------|
| 1 | STROBE |
| 2 - 9 | DATA 0 – 7 |
| 10 | ACKNOWLEDGE |
| 11 | BUSY |
| 12 | PAPER END |
| 15 | ERROR |
| 18 - 25 | GROUND |

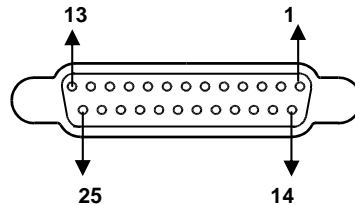

10/100 LAN Port

RJ-45 modular 8-pin jack. 10/100 Mbps

| Pin | Signal |
|-----|--------|
| 1 | TxD+ |
| 2 | TxD- |
| 3 | RxD+ |
| 6 | RxD- |

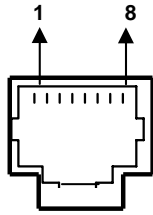

Video Port

15-pin D-type female connector

| Pin | Signal |
|-----|---------------|
| 1 | Red |
| 2 | Green |
| 3 | Blue |
| 4 | No Connection |
| 5 | GND |

| Pin | Signal |
|-----|------------------|
| 6 | Red return GND |
| 7 | Green return GND |
| 8 | Blue return GND |
| 9 | No Connection |
| 10 | No Connection |

| Pin | Signal |
|-----|-----------------|
| 11 | No Connection |
| 12 | No Connection |
| 13 | Horizontal Sync |
| 14 | Vertical Sync |
| 15 | No Connection |

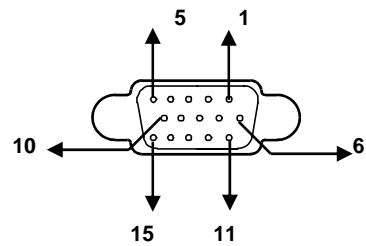

Mouse / Keyboard Port

PS/2 Mouse / Keyboard connector

| Pin | Signal |
|-----|------------------|
| 1 | Mouse / KBD data |
| 2 | NC |
| 3 | GND |

| Pin | Signal |
|-----|-------------------|
| 4 | VCC |
| 5 | Mouse / KBD Clock |
| 6 | NC |

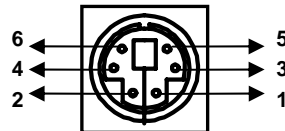

Audio / Microphone Port

Standard audio jacks.

USB Port

4-pin series-A receptacle. 4~ 5 ports depending on the model. Both USB1.1 and USB2.0 models are available.

| Pin | Signal |
|-----|--------|
| 1 | VCC |
| 2 | D- |
| 3 | D+ |
| 4 | GND |

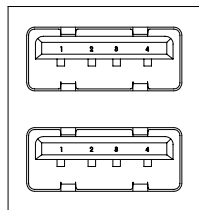

Cables

10/100 LAN Cable

Cross Connection - (Without Hub)

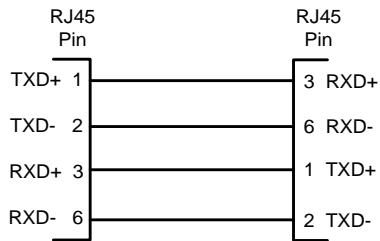

Straight Connection - (With Hub)

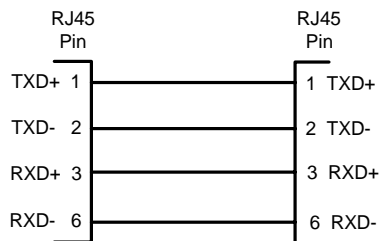

COM Port (Serial Port) Cables

Serial devices like modems and printers use 25 pin D-type connectors for RS232 connections. In order to connect an RS232 device with a 25-pin connector, 9-pin connector signals must be converted to 25-pin connector signals as shown in the following diagram.

9-pin to 25-pin Cross Connection

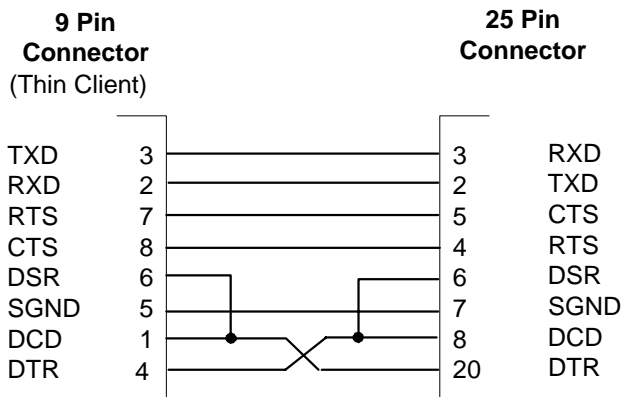

9-pin to 25-pin Straight Connection

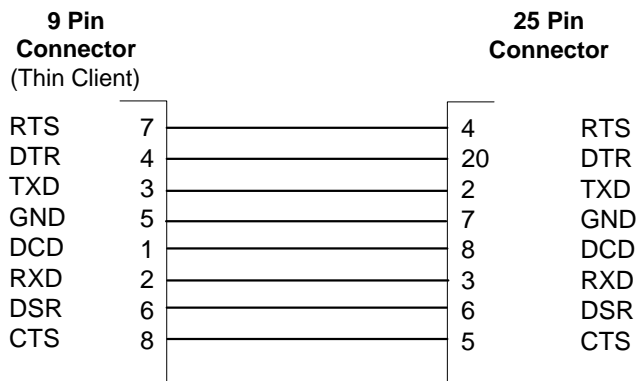

Printer Cable

The following table shows the pin connections of the Standard Centronics parallel cable. Some manufacturers change pin functions or polarity on their printers. For such printers, custom cables may be necessary. Refer to your printer manual for cabling information in such cases.

Note: Please use certified shielded cable only.

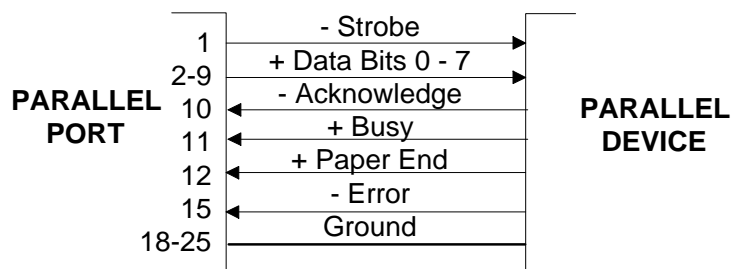

Troubleshooting

This chapter contains solutions for problems you may encounter while using the product.

| <i>Problem</i> | <i>Solution</i> |
|--|--|
| <ul style="list-style-type: none">• The Power-LED on front panel does not glow when the client is switched on. | <ul style="list-style-type: none">✓ Ensure that the power cord is plugged into an AC outlet.✓ Check the fuse in the power-plug, if available. |
| <ul style="list-style-type: none">• There is no display, though the power-indicating LED glows. | <ul style="list-style-type: none">✓ Ensure that the video cable is properly connected. |
| <ul style="list-style-type: none">• The mouse (<i>or</i> keyboard) does not work when the client is switched on. | <ul style="list-style-type: none">✓ Ensure that the mouse (<i>or keyboard</i>) is plugged into the correct PS/2 port on the rear panel |