

TOSHIBA

FILE NO. A00-T004

SERVICE MANUAL

AIR-CONDITIONER

SPLIT TYPE

RAS-10YKV-E/RAS-10YAV-E *RAS-13YKV-E/RAS-13YAV-E*

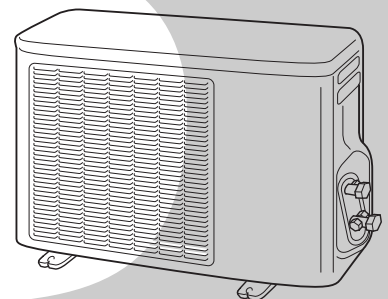
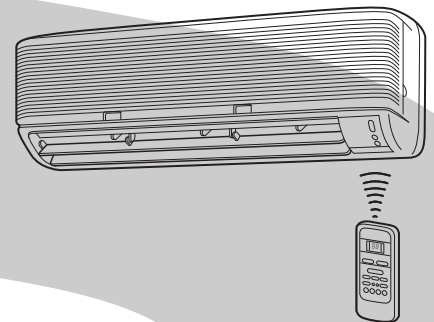

CONTENTS

1. SPECIFICATIONS	3
2. REFRIGERANT R410A	6
3. CONSTRUCTION VIEWS	14
4. WIRING DIAGRAM.....	16
5. SPECIFICATIONS OF ELECTRICAL PARTS.....	18
6. REFRIGERANT CYCLE DIAGRAM	19
7. CONTROL BLOCK DIAGRAM	21
8. OPERATION DESCRIPTION	23
9. INSTALLATION PROCEDURE	36
10. HOW TO DIAGNOSE THE TROUBLE	40
11. HOW TO REPLACE THE MAIN PARTS	59
12. EXPLODED VIEWS AND PARTS LIST.....	69

1. SPECIFICATIONS

1-1. Specifications

RAS-10YKV-E/RAS-10YAV-E

Unit model	Indoor		RAS-10YKV-E	
	Outdoor		RAS-10YAV-E	
Current limited			—	
Cooling capacity	(kW)		2,7	
Cooling capacity range	(kW)		0,8 – 3,4	
Heating capacity	(kW)		3,6	
Heating capacity range	(kW)		0,8 – 6,2	
Power supply			220 – 230 –240V – 1Ph – 50/60Hz	
Electric characteristics	Indoor	Operation mode	Cooling	
		Running current (A)	0,15	
		Power consumption (W)	30	
		Power factor (%)	87	
	Outdoor	Operation mode	Cooling	
		Running current (A)	3,39 / 3,23 / 3,09	
		Power consumption (W)	670	
		Power factor (%)	90	
		Starting current (A)	4,55 / 4,35 / 4,17	
				Heating
		4,40 / 4,20 / 4,02		
COP (Cooling/Heating)			3,86 / 4,00	
Operating noise	Indoor	High (Cooling / Heating) (dB•A)	38 / 39	
		Medium (Cooling / Heating) (dB•A)	34 / 35	
		Low (Cooling / Heating) (dB•A)	30 / 30	
	Outdoor	(Cooling / Heating) (dB•A)	45 / 46	
Indoor unit	Unit model		RAS-10YKV-E	
	Dimension	Height (mm)	265	
		Width (mm)	790	
		Depth (mm)	189	
	Net weight (kg)	8		
	Fan motor output (W)	19		
	Air flow rate (Cooling / Heating) (m³/h)	480 / 520		
Outdoor unit	Unit model		RAS-10YAV-E	
	Dimension	Height (mm)	550	
		Width (mm)	780	
		Depth (mm)	270	
	Net weight (kg)	38		
	Compressor	Motor output (W)	750	
		Type	Twin rotary type with DC-inverter variable speed control	
		Model	DA91A1F-44F	
	Fan motor output (W)	40		
	Air flow rate (Cooling / Heating) (m³/h)	2120 / 2120		
Piping connection	Type		Flare connection	
	Indoor unit	Liquid side	Ø6,35	
		Gas side	Ø9,52	
	Outdoor unit	Liquid side	Ø6,35	
		Gas side	Ø9,52	
	Maximum length (Per unit) (m)	15		
	Maximum chargeless length (m)	15		
	Maximum height difference (m)	10		
Refrigerant	Name of refrigerant		R410A	
	Weight (kg)		0,8	
Wiring connection	Power supply		3 Wires : includes earth	
	Interconnection		4 Wires : includes earth	
Usable temperature range	Indoor (Cooling / Heating) (°C)		21 – 32 / 0 – 28	
	Outdoor (Cooling / Heating) (°C)		10 – 43 / –10 – 21	
Accessory	Indoor unit	Installation plate	1	
		Wireless remote control	1	
		Label	2	
		Remote controller holder	1	
		Pan head wood screw	2 (Ø3,1 x 16L)	
		Purifying filter	1	
		Deodorizing filter	1	
		Batteries	2	
		Mounting screw	6 (Ø4 x 25L)	
		Installation manual	1	
		Owner's manual	1	
	Outdoor unit	Drain nipple	1	

- The specifications may be subject to change without notice for purpose of improvement.

RAS-13YKV-E/RAS-13YAV-E

Unit model		Indoor	RAS-13YKV-E	
		Outdoor	RAS-13YAV-E	
Current limited			—	
Cooling capacity		(kW)	3,7	
Cooling capacity range		(kW)	0,8 – 4,0	
Heating capacity		(kW)	4,8	
Heating capacity range		(kW)	0,8 – 6,6	
Power supply			220 – 230 – 240V – 1Ph – 50/60Hz	
Electric characteristics	Indoor	Operation mode	Cooling	Heating
		Running current (A)	0,15	0,15
		Power consumption (W)	30	30
		Power factor (%)	87	87
	Outdoor	Operation mode	Cooling	Heating
		Running current (A)	5,59 / 5,34 / 5,11	7,03 / 6,71 / 6,43
		Power consumption (W)	1170	1470
		Power factor (%)	95	95
Starting current (A)		7,18 / 6,86 / 6,58		
COP (Cooling/Heating)			3,08 / 3,20	
Operating noise	Indoor	High (Cooling / Heating) (dB•A)	41 / 41	
		Medium (Cooling / Heating) (dB•A)	36 / 36	
		Low (Cooling / Heating) (dB•A)	30 / 30	
	Outdoor (Cooling / Heating) (dB•A)	48 / 50		
Indoor unit	Unit model		RAS-13YKV-E	
	Dimension	Height (mm)	265	
		Width (mm)	790	
		Depth (mm)	189	
	Net weight (kg)	8		
	Fan motor output (W)	19		
Air flow rate (Cooling / Heating) (m³/h)	530 / 560			
Outdoor unit	Unit model		RAS-13YAV-E	
	Dimension	Height (mm)	550	
		Width (mm)	780	
		Depth (mm)	270	
	Net weight (kg)	38		
	Compressor	Motor output (W)	750	
		Type	Twin rotary type with DC-inverter variable speed control	
		Model	DA91A1F-44F	
	Fan motor output (W)	40		
Air flow rate (Cooling / Heating) (m³/h)	2520 / 2520			
Piping connection	Type		Flare connection	
	Indoor unit	Liquid side	Ø6,35	
		Gas side	Ø9,52	
	Outdoor unit	Liquid side	Ø6,35	
		Gas side	Ø9,52	
	Maximum length (Per unit) (m)	15		
	Maximum chargeless length (m)	15		
	Maximum height difference (m)	10		
Refrigerant	Name of refrigerant		R410A	
	Weight (kg)		0,8	
Wiring connection		Power supply	3 Wires : includes earth	
		Interconnection	4 Wires : includes earth	
Usable temperature range		Indoor (Cooling / Heating) (°C)	21 – 32 / 0 – 28	
		Outdoor (Cooling / Heating) (°C)	10 – 43 / –10 – 21	
Accessory	Indoor unit	Installation plate	1	
		Wireless remote control	1	
		Label	2	
		Remote controller holder	1	
		Pan head wood screw	2 (Ø3,1 x 16L)	
		Purifying filter	1	
		Deodorizing filter	1	
		Batteries	2	
		Mounting screw	6 (Ø4 x 25L)	
		Installation manual	1	
	Owner's manual	1		
Outdoor unit	Drain nipple	1		

- The specifications may be subject to change without notice for purpose of improvement.

1-2. Operation Characteristic Curve

<Cooling>

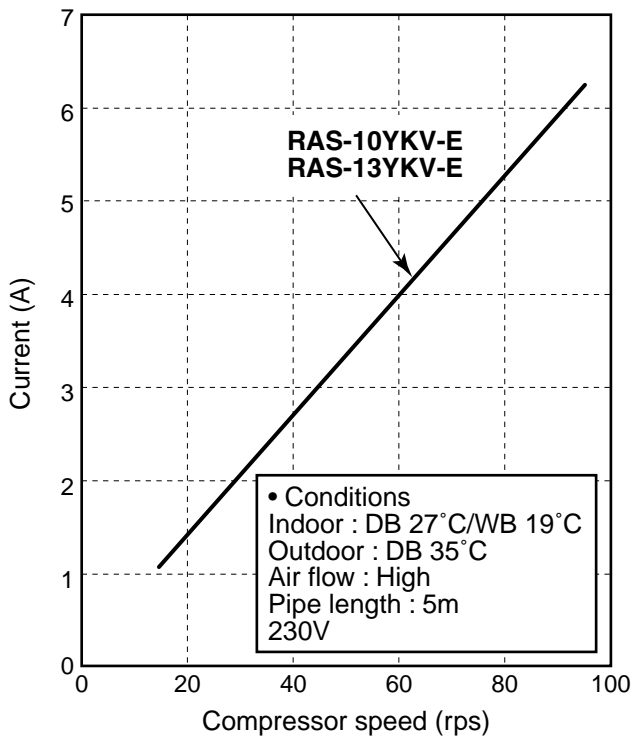

<Heating>

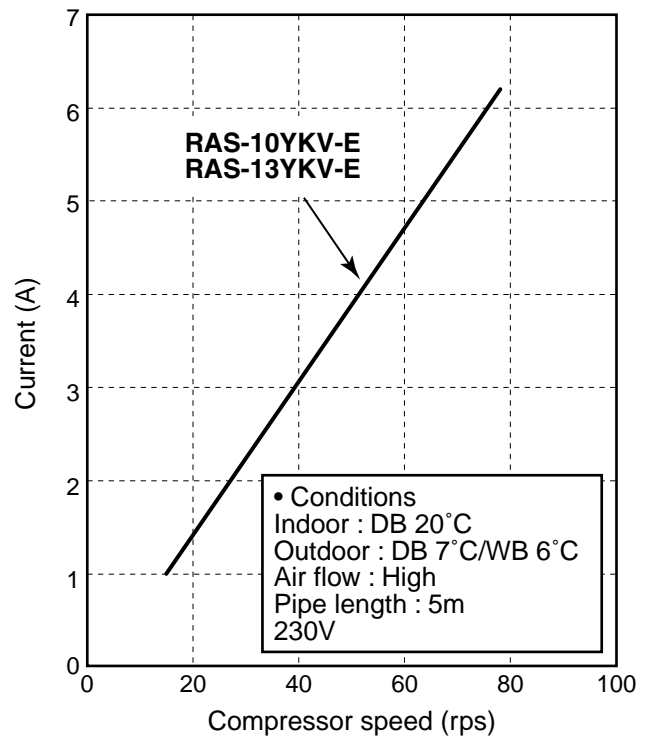

1-3. Capacity Variation Ratio According to Temperature

<Cooling>

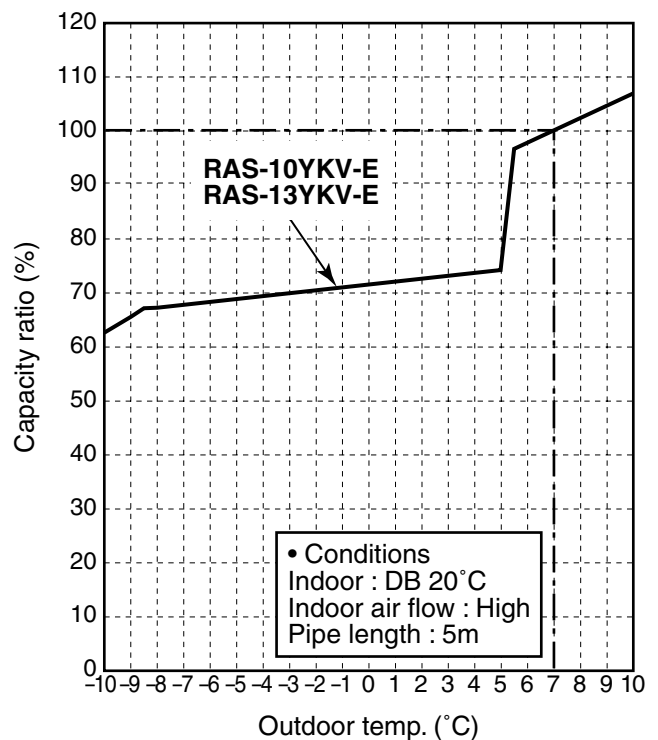
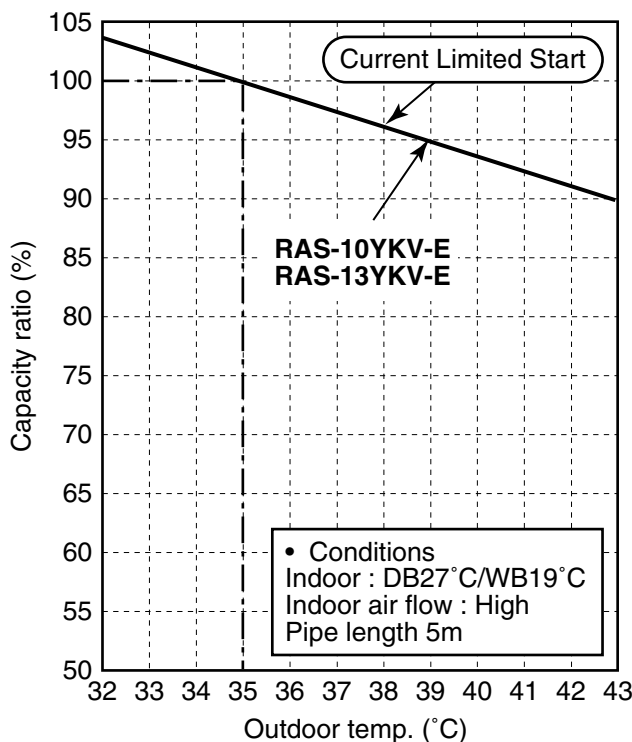

* Capacity ratio : 100% = 2,7 kW (RAS-10YKV-E)
100% = 3,7 kW (RAS-13YKV-E)

2. REFRIGERANT R410A

This air conditioner adopts the new refrigerant HFC (R410A) which does not damage the ozone layer.

The working pressure of the new refrigerant R410A is 1,6 times higher than conventional refrigerant (R22). The refrigerating oil is also changed in accordance with change of refrigerant, so be careful that water, dust, and existing refrigerant or refrigerating oil are not entered in the refrigerant cycle of the air conditioner using the new refrigerant during installation work or servicing time.

The next section describes the precautions for air conditioner using the new refrigerant. Conforming to contents of the next section together with the general cautions included in this manual, perform the correct and safe work.

2-1. Safety During Installation/Serviceing

As R410A's pressure is about 1,6 times higher than that of R22, improper installation/servicing may cause a serious trouble. By using tools and materials exclusive for R410A, it is necessary to carry out installation/servicing safely while taking the following precautions into consideration.

- (1) Never use refrigerant other than R410A in an air conditioner which is designed to operate with R410A.

If other refrigerant than R410A is mixed, pressure in the refrigeration cycle becomes abnormally high, and it may cause personal injury, etc. by a rupture.

- (2) Confirm the used refrigerant name, and use tools and materials exclusive for the refrigerant R410A.

The refrigerant name R410A is indicated on the visible place of the outdoor unit of the air conditioner using R410A as refrigerant. To prevent mischarging, the diameter of the service port differs from that of R22.

- (3) If a refrigeration gas leakage occurs during installation/servicing, be sure to ventilate fully.
If the refrigerant gas comes into contact with fire, a poisonous gas may occur.
- (4) When installing or removing an air conditioner, do not allow air or moisture to remain in the refrigeration cycle. Otherwise, pressure in the refrigeration cycle may become abnormally high so that a rupture or personal injury may be caused.

- (5) After completion of installation work, check to make sure that there is no refrigeration gas leakage.

If the refrigerant gas leaks into the room, coming into contact with fire in the fan-driven heater, space heater, etc., a poisonous gas may occur.

- (6) When an air conditioning system charged with a large volume of refrigerant is installed in a small room, it is necessary to exercise care so that, even when refrigerant leaks, its concentration does not exceed the marginal level.

If the refrigerant gas leakage occurs and its concentration exceeds the marginal level, an oxygen starvation accident may result.

- (7) Be sure to carry out installation or removal according to the installation manual.

Improper installation may cause refrigeration trouble, water leakage, electric shock, fire, etc.

- (8) Unauthorized modifications to the air conditioner may be dangerous. If a breakdown occurs please call a qualified air conditioner technician or electrician.

Improper repair's may result in water leakage, electric shock and fire, etc.

2-2. Refrigerant Piping Installation

2-2-1. Piping Materials and Joints Used

For the refrigerant piping installation, copper pipes and joints are mainly used. Copper pipes and joints suitable for the refrigerant must be chosen and installed. Furthermore, it is necessary to use clean copper pipes and joints whose interior surfaces are less affected by contaminants.

- (1) Copper Pipes

It is necessary to use seamless copper pipes which are made of either copper or copper alloy and it is desirable that the amount of residual oil is less than 40 mg/10 m. Do not use copper pipes having a collapsed, deformed or discolored portion (especially on the interior surface). Otherwise, the expansion valve or capillary tube may become blocked with contaminants.

As an air conditioner using R410A incurs pressure higher than when using R22, it is necessary to choose adequate materials.

Thicknesses of copper pipes used with R410A are as shown in Table 2-2-1. Never use copper pipes thinner than 0,8 mm even when it is available on the market.

Table 2-2-1 Thicknesses of annealed copper pipes

		Thickness (mm)	
Nominal diameter	Outer diameter (mm)	R410A	R22
1/4	6,35	0,80	0,80
3/8	9,52	0,80	0,80
1/2	12,70	0,80	0,80
5/8	15,88	1,00	1,00

(2) Joints

For copper pipes, flare joints or socket joints are used. Prior to use, be sure to remove all contaminants.

a) Flare Joints

Flare joints used to connect the copper pipes cannot be used for pipings whose outer diameter exceeds 20 mm. In such a case, socket joints can be used.

Sizes of flare pipe ends, flare joint ends and flare nuts are as shown in Tables 2-2-3 to 2-2-6 below.

b) Socket Joints

Socket joints are such that they are brazed for connections, and used mainly for thick pipings whose diameter is larger than 20 mm. Thicknesses of socket joints are as shown in Table 2-2-2.

Table 2-2-2 Minimum thicknesses of socket joints

Nominal diameter	Reference outer diameter of copper pipe jointed (mm)	Minimum joint thickness (mm)
1/4	6,35	0,50
3/8	9,52	0,60
1/2	12,70	0,70
5/8	15,88	0,80

2-2-2. Processing of Piping Materials

When performing the refrigerant piping installation, care should be taken to ensure that water or dust does not enter the pipe interior, that no other oil other than lubricating oils used in the installed air conditioner is used, and that refrigerant does not leak. When using lubricating oils in the piping processing, use such lubricating oils whose water content has been removed. When stored, be sure to seal the container with an airtight cap or any other cover.

(1) Flare Processing Procedures and Precautions

a) Cutting the Pipe

By means of a pipe cutter, slowly cut the pipe so that it is not deformed.

b) Removing Burrs and Chips

If the flared section has chips or burrs, refrigerant leakage may occur. Carefully remove all burrs and clean the cut surface before installation.

- c) Insertion of Flare Nut
- d) Flare Processing

Make certain that a clamp bar and copper pipe have been cleaned.

By means of the clamp bar, perform the flare processing correctly.

Use either a flare tool for R410A or conventional flare tool.

Flare processing dimensions differ according to the type of flare tool. When using a conventional flare tool, be sure to secure "dimension A" by using a gauge for size adjustment.

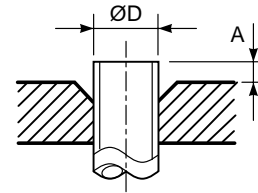

Fig. 2-2-1 Flare processing dimensions

Table 2-2-3 Dimensions related to flare processing for R410A

Nominal diameter	Outer diameter (mm)	Thickness (mm)	A (mm)		
			Flare tool for R410A clutch type	Conventional flare tool	
				Clutch type	Wing nut type
1/4	6,35	0,8	0 to 0,5	1,0 to 1,5	1,5 to 2,0
3/8	9,52	0,8	0 to 0,5	1,0 to 1,5	1,5 to 2,0
1/2	12,70	0,8	0 to 0,5	1,0 to 1,5	2,0 to 2,5
5/8	15,88	1,0	0 to 0,5	1,0 to 1,5	2,0 to 2,5

Table 2-2-4 Dimensions related to flare processing for R22

Nominal diameter	Outer diameter (mm)	Thickness (mm)	A (mm)		
			Flare tool for R410A clutch type	Conventional flare tool	
				Clutch type	Wing nut type
1/4	6,35	0,8	0 to 0,5	0,5 to 1,0	1,0 to 1,5
3/8	9,52	0,8	0 to 0,5	0,5 to 1,0	1,0 to 1,5
1/2	12,70	0,8	0 to 0,5	0,5 to 1,0	1,0 to 2,0
5/8	15,88	1,0	0 to 0,5	0,5 to 1,0	1,0 to 2,0

Table 2-2-5 Flare and flare nut dimensions for R410A

Nominal diameter	Outer diameter (mm)	Thickness (mm)	Dimension (mm)				Flare nut width (mm)
			A	B	C	D	
1/4	6,35	0,8	9,1	9,2	6,5	13	17
3/8	9,52	0,8	13,2	13,5	9,7	20	22
1/2	12,70	0,8	16,6	16,0	12,9	23	26
5/8	15,88	1,0	19,7	19,0	16,0	25	29

Table 2-2-6 Flare and flare nut dimensions for R22

Nominal diameter	Outer diameter (mm)	Thickness (mm)	Dimension (mm)				Flare nut width (mm)
			A	B	C	D	
1/4	6,35	0,8	9,0	9,2	6,5	13	17
3/8	9,52	0,8	13,0	13,5	9,7	20	22
1/2	12,70	0,8	16,2	16,0	12,9	20	24
5/8	15,88	1,0	19,7	19,0	16,0	23	27
3/4	19,05	1,0	23,3	24,0	19,2	34	36

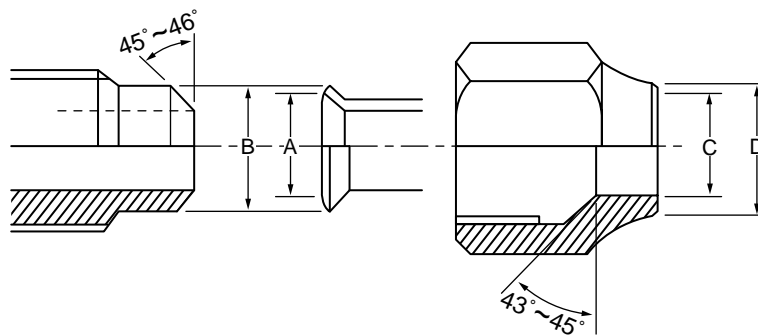

Fig. 2-2-2 Relations between flare nut and flare seal surface

(2) Flare Connecting Procedures and Precautions

- a) Make sure that the flare and union portions do not have any scar or dust, etc.
- b) Correctly align the processed flare surface with the union axis.
- c) Tighten the flare with designated torque by means of a torque wrench. The tightening torque for R410A is the same as that for conventional R22. Incidentally, when the torque is weak, the gas leakage may occur.

When it is strong, the flare nut may crack and may be made non-removable. When choosing the tightening torque, comply with values designated by manufacturers. Table 2-2-7 shows reference values.

Note:

When applying oil to the flare surface, be sure to use oil designated by the manufacturer. If any other oil is used, the lubricating oils may deteriorate and cause the compressor to burn out.

Table 2-2-7 Tightening torque of flare for R410A [Reference values]

Nominal diameter	Outer diameter (mm)	Tightening torque N•m (kgf•cm)	Tightening torque of torque wrenches available on the market N•m (kgf•cm)
1/4	6,35	14 to 18 (140 to 180)	16 (160), 18 (180)
3/8	9,52	33 to 42 (330 to 420)	42 (420)
1/2	12,70	50 to 62 (500 to 620)	55 (550)
5/8	15,88	63 to 77 (630 to 770)	65 (650)

2-3. Tools

2-3-1. Required Tools

The service port diameter of packed valve of the outdoor unit in the air conditioner using R410A is changed to prevent mixing of other refrigerant. To reinforce the pressure-resisting strength, flare processing dimensions and opposite side dimension of flare nut (For Ø12,7 copper pipe) of the refrigerant piping are lengthened.

The used refrigerating oil is changed, and mixing of oil may cause a trouble such as generation of sludge, clogging of capillary, etc. Accordingly, the tools to be used are classified into the following three types.

- (1) Tools exclusive for R410A (Those which cannot be used for conventional refrigerant (R22))
- (2) Tools exclusive for R410A, but can be also used for conventional refrigerant (R22)
- (3) Tools commonly used for R410A and for conventional refrigerant (R22)

The table below shows the tools exclusive for R410A and their interchangeability.

Tools exclusive for R410A (The following tools for R410A are required.)

Tools whose specifications are changed for R410A and their interchangeability

No.	Used tool	Usage	R410A air conditioner installation		Conventional air conditioner installation
			Existence of new equipment for R410A	Whether conventional equipment can be used	Whether new equipment can be used with conventional refrigerant
①	Flare tool	Pipe flaring	Yes	*(Note 1)	○
②	Copper pipe gauge for adjusting projection margin	Flaring by conventional flare tool	Yes	*(Note 1)	*(Note 1)
③	Torque wrench (For Ø12,7)	Connection of flare nut	Yes	×	×
④	Gauge manifold	Evacuating, refrigerant charge, run check, etc.	Yes	×	×
⑤	Charge hose				
⑥	Vacuum pump adapter	Vacuum evacuating	Yes	×	○
⑦	Electronic balance for refrigerant charging	Refrigerant charge	Yes	×	○
⑧	Refrigerant cylinder	Refrigerant charge	Yes	×	×
⑨	Leakage detector	Gas leakage check	Yes	×	○
⑩	Charging cylinder	Refrigerant charge	(Note 2)	×	×

(Note 1) When flaring is carried out for R410A using the conventional flare tools, adjustment of projection margin is necessary. For this adjustment, a copper pipe gauge, etc. are necessary.

(Note 2) Charging cylinder for R410A is being currently developed.

General tools (Conventional tools can be used.)

In addition to the above exclusive tools, the following equipments which serve also for R22 are necessary as the general tools.

- | | | |
|---|------------------------------|---|
| (1) Vacuum pump | (4) Reamer | (9) Hole core drill (Ø65) |
| Use vacuum pump by attaching vacuum pump adapter. | (5) Pipe bender | (10) Hexagon wrench (Opposite side 5mm) |
| (2) Torque wrench (For Ø6,35) | (6) Level vial | (11) Tape measure |
| (3) Pipe cutter | (7) Screwdriver (+, -) | (12) Metal saw |
| | (8) Spanner or Monkey wrench | |

Also prepare the following equipments for other installation method and run check.

- | | |
|-----------------|----------------------------------|
| (1) Clamp meter | (3) Insulation resistance tester |
| (2) Thermometer | (4) Electroscop |

2-4. Recharging of Refrigerant

When it is necessary to recharge refrigerant, charge the specified amount of new refrigerant according to the following steps.

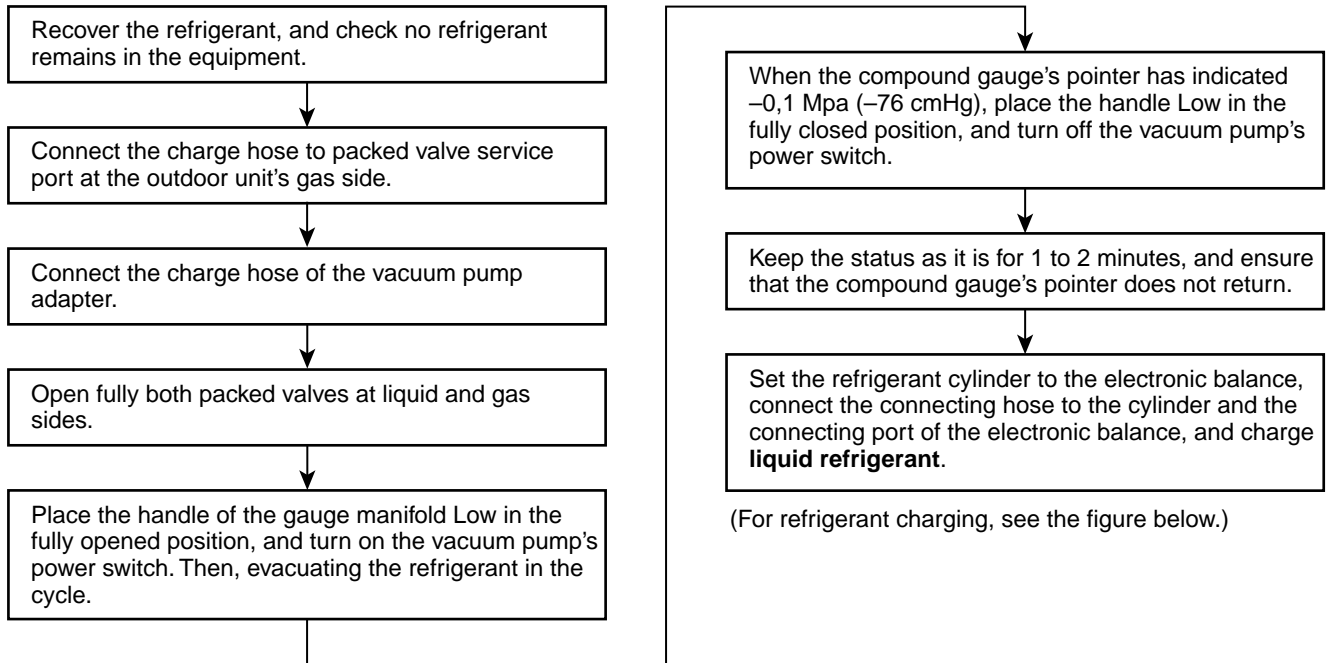

- ① Never charge refrigerant exceeding the specified amount.
- ② If the specified amount of refrigerant cannot be charged, charge refrigerant **bit by bit** in COOL mode.
- ③ Do not carry out additional charging.
When additional charging is carried out if refrigerant leaks, the refrigerant composition changes in the refrigeration cycle, that is characteristics of the air conditioner changes, refrigerant exceeding the specified amount is charged, and working pressure in the refrigeration cycle becomes abnormally high pressure, and may cause a rupture or personal injury.

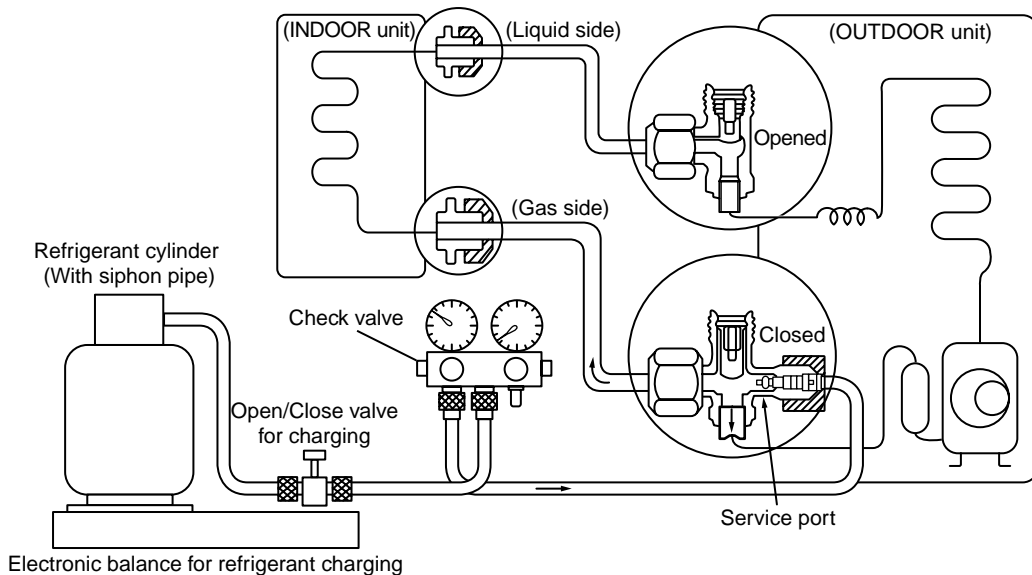
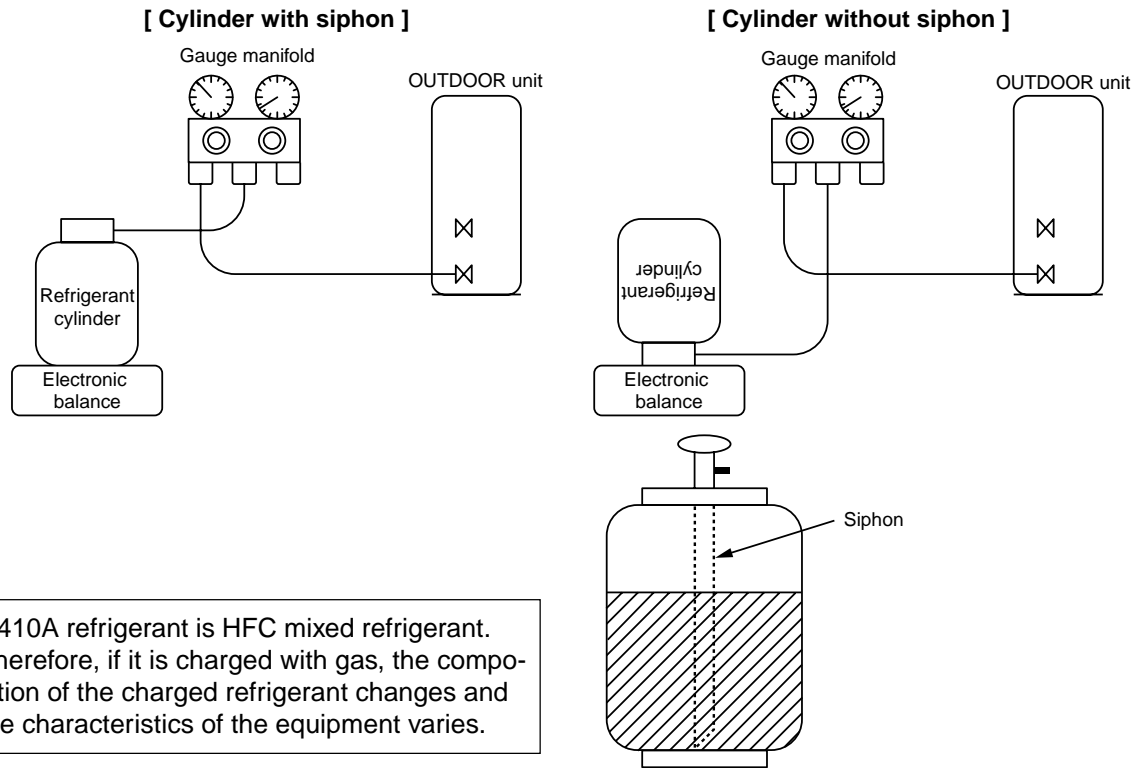

Fig. 2-4-1 Configuration of refrigerant charging

- ① Be sure to make setting so that **liquid** can be charged.
- ② When using a cylinder equipped with a siphon, liquid can be charged without turning it upside down.

It is necessary for charging refrigerant under condition of liquid because R410A is mixed type of refrigerant. Accordingly, when charging refrigerant from the refrigerant cylinder to the equipment, charge it turning the cylinder upside down if cylinder is not equipped with siphon.



R410A refrigerant is HFC mixed refrigerant. Therefore, if it is charged with gas, the composition of the charged refrigerant changes and the characteristics of the equipment varies.

Fig. 2-4-2

2-5. Brazing of Pipes

2-5-1. Materials for Brazing

(1) Silver brazing filler

Silver brazing filler is an alloy mainly composed of silver and copper. It is used to join iron, copper or copper alloy, and is relatively expensive though it excels in solderability.

(2) Phosphor bronze brazing filler

Phosphor bronze brazing filler is generally used to join copper or copper alloy.

(3) Low temperature brazing filler

Low temperature brazing filler is generally called solder, and is an alloy of tin and lead. Since it is weak in adhesive strength, do not use it for refrigerant pipes.

- ① Phosphor bronze brazing filler tends to react with sulfur and produce a fragile compound water solution, which may cause a gas leakage. Therefore, use any other type of brazing filler at a hot spring resort, etc., and coat the surface with a paint.
- ② When performing brazing again at time of servicing, use the same type of brazing filler.

2-5-2. Flux

(1) Reason why flux is necessary

- By removing the oxide film and any foreign matter on the metal surface, it assists the flow of brazing filler.
- In the brazing process, it prevents the metal surface from being oxidized.
- By reducing the brazing filler's surface tension, the brazing filler adheres better to the treated metal.

(2) Characteristics required for flux

- Activated temperature of flux coincides with the brazing temperature.
- Due to a wide effective temperature range, flux is hard to carbonize.
- It is easy to remove slag after brazing.
- The corrosive action to the treated metal and brazing filler is minimum.
- It excels in coating performance and is harmless to the human body.

As the flux works in a complicated manner as described above, it is necessary to select an adequate type of flux according to the type and shape of treated metal, type of brazing filler and brazing method, etc.

(3) Types of flux

• Noncorrosive flux

Generally, it is a compound of borax and boric acid.

It is effective in case where the brazing temperature is higher than 800°C.

• Activated flux

Most of fluxes generally used for silver brazing are this type.

It features an increased oxide film removing capability due to the addition of compounds such as potassium fluoride, potassium chloride and sodium fluoride to the borax-boric acid compound.

(4) Piping materials for brazing and used brazing filler/flux

Piping material	Used brazing filler	Used flux
Copper - Copper	Phosphor copper	Do not use
Copper - Iron	Silver	Paste flux
Iron - Iron	Silver	Vapor flux

- ① Do not enter flux into the refrigeration cycle.
- ② When chlorine contained in the flux remains within the pipe, the lubricating oil deteriorates. Therefore, use a flux which does not contain chlorine.
- ③ When adding water to the flux, use water which does not contain chlorine (e.g. distilled water or ion-exchange water).
- ④ Remove the flux after brazing.

2-5-3. Brazing

As brazing work requires sophisticated techniques, experiences based upon a theoretical knowledge, it must be performed by a person qualified.

In order to prevent the oxide film from occurring in the pipe interior during brazing, it is effective to proceed with brazing while letting dry Nitrogen gas (N₂) flow.

Never use gas other than Nitrogen gas.

(1) Brazing method to prevent oxidation

- ① Attach a reducing valve and a flow-meter to the Nitrogen gas cylinder.
- ② Use a copper pipe to direct the piping material, and attach a flow-meter to the cylinder.
- ③ Apply a seal onto the clearance between the piping material and inserted copper pipe for Nitrogen in order to prevent backflow of the Nitrogen gas.
- ④ When the Nitrogen gas is flowing, be sure to keep the piping end open.
- ⑤ Adjust the flow rate of Nitrogen gas so that it is lower than 0,05 m³/Hr or 0,02 MPa (0,2kgf/cm²) by means of the reducing valve.
- ⑥ After performing the steps above, keep the Nitrogen gas flowing until the pipe cools down to a certain extent (temperature at which pipes are touchable with hands).
- ⑦ Remove the flux completely after brazing.

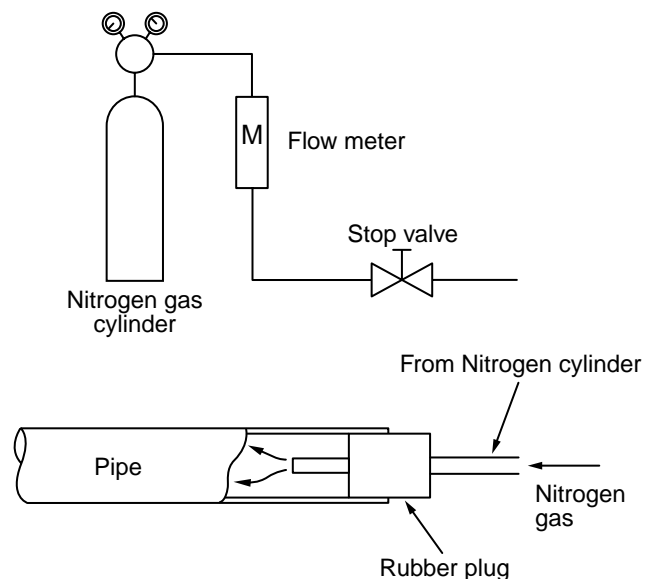
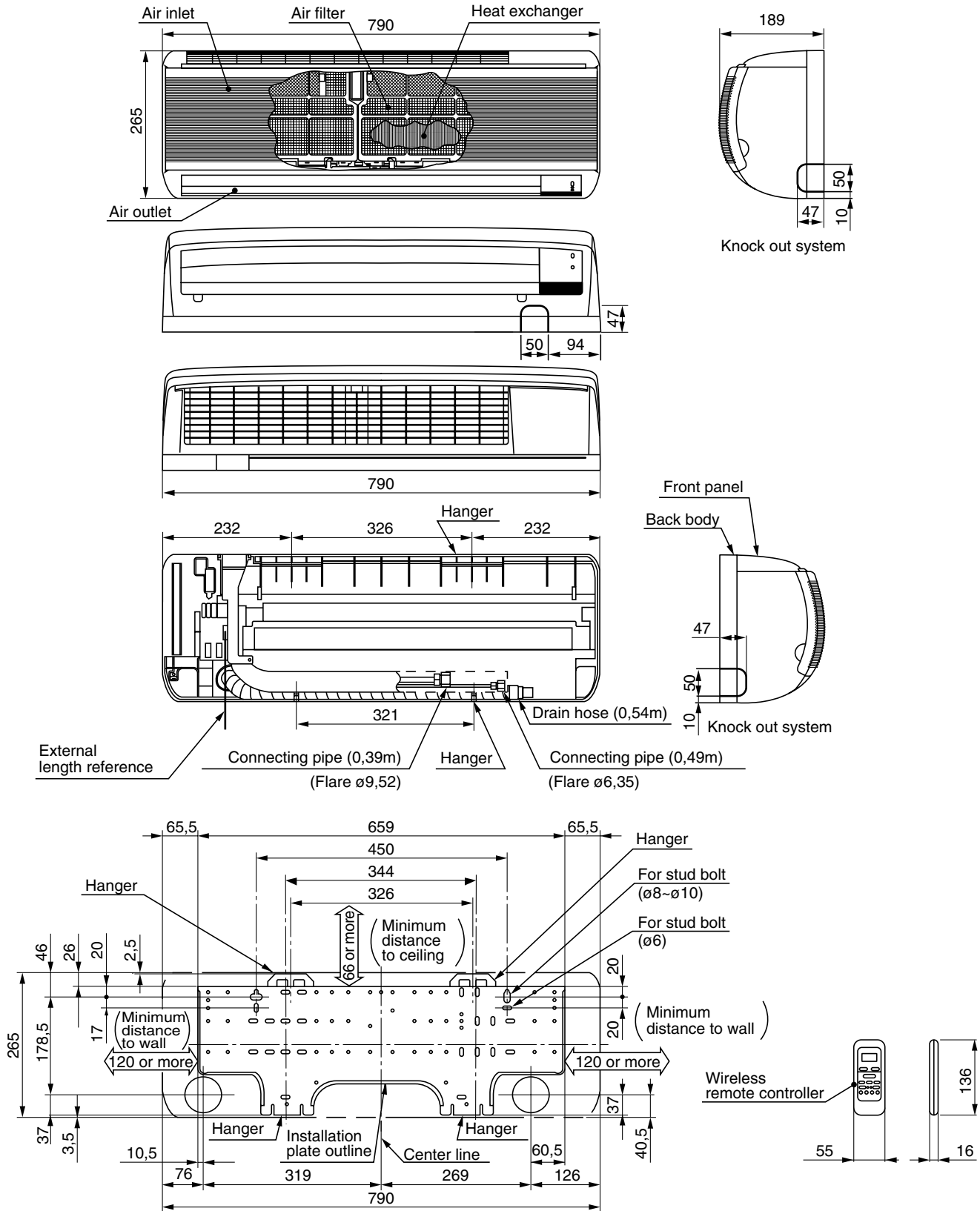

Fig. 2-5-1 Prevention of oxidation during brazing

3. CONSTRUCTION VIEWS

3-1. Indoor Unit

RAS-10YKV-E, RAS-13YKV-E



3-2. Outdoor Unit

RAS-10YAV-E
RAS-13YAV-E

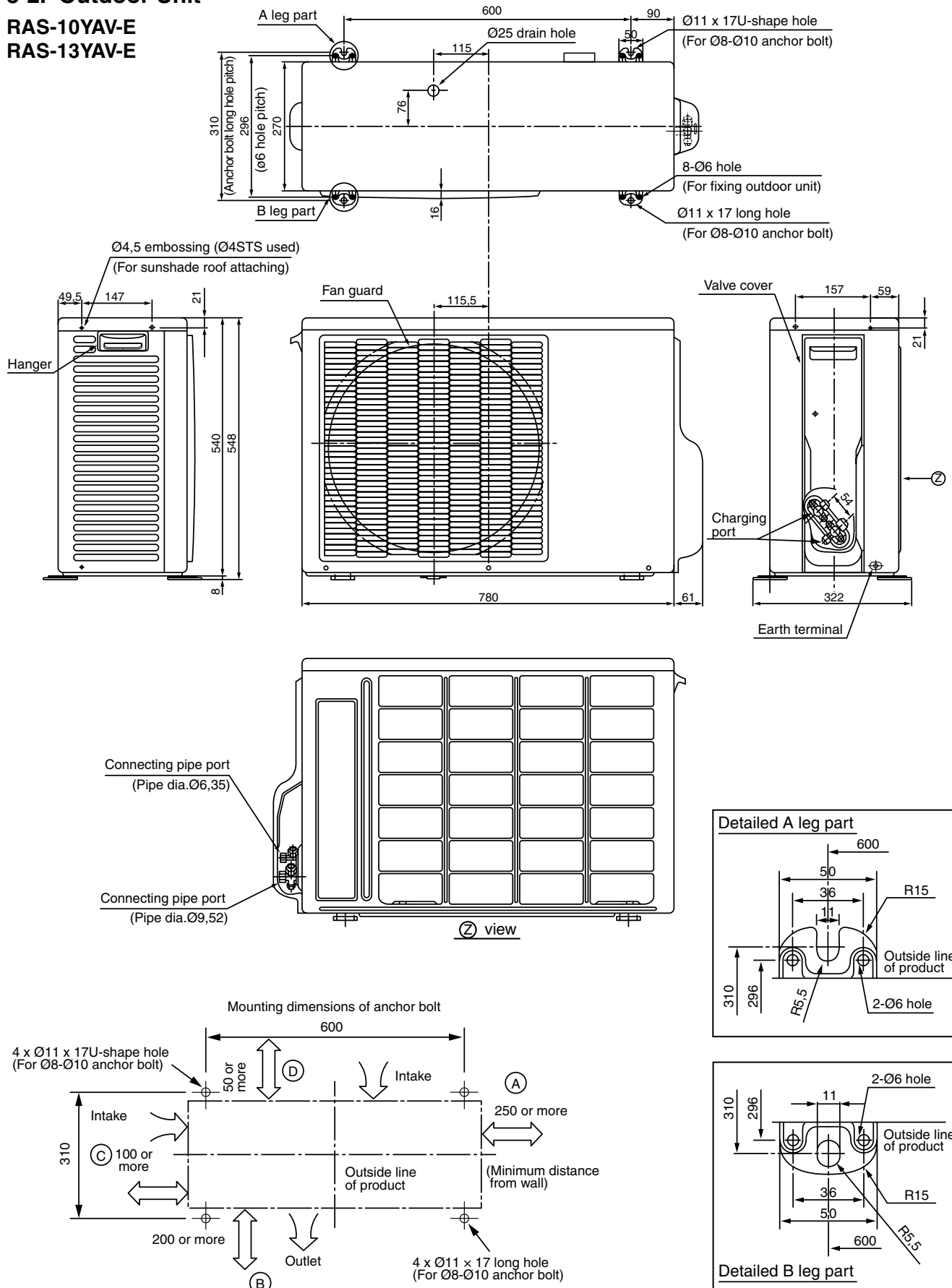

4. WIRING DIAGRAM

4-1. Indoor Unit

RAS-10YKV-E, RAS-13YKV-E

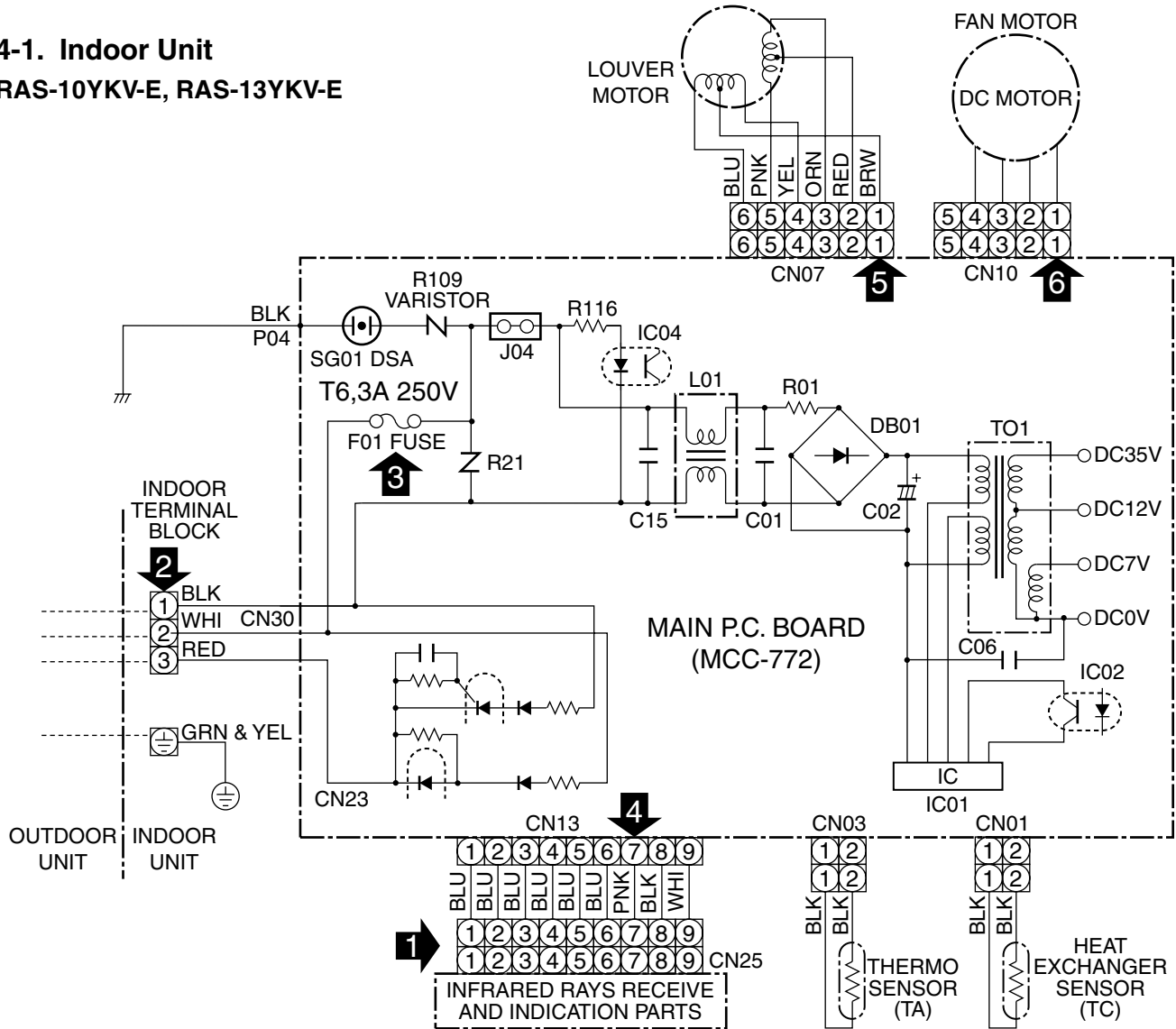

Table 4-1-1 Simple check points for diagnosing faults

Check items	Diagnosis result
1 OPERATION indicator	Check to see if the OPERATION indicator goes on and off when the main switch or breaker is turned on, or the power cord is plugged in the wall outlet. (Check the primary and secondary voltage of transformer.)
2 Terminal block	Check for power supply voltage between ① – ②. (Refer to the name plate.) (Check the primary and secondary voltage of transformer.) Check for fluctuate voltage between ② – ③. (DC 15 to 60V)
3 Fuse 6,3A	Check to determine if the fuse is open. (Check Varistor : R109, R21)
4 DC 5V	Check for voltage at the pink lead of the infrared rays receive parts. (Check the transformer and the rated voltage power supply circuit.)
5 DC 12V	Check for voltage at the ①③ lead of louver motor. (Check the transformer and the rated voltage power supply circuit.)
6 DC 35V	Check for voltage at the CN10 connector side point. (Check the transformer and the rated voltage power supply circuit.)

COLOR IDENTIFICATION	
BRW	: BROWN
RED	: RED
WHI	: WHITE
YEL	: YELLOW
BLU	: BLUE
BLK	: BLACK
GRY	: GRAY
PNK	: PINK
ORN	: ORANGE
GRN & YEL	: GREEN & YELLOW

For detailed diagnostic procedure, refer to the service data.
DSA : Surge Absorber

4-2. Outdoor Unit

RAS-10YAV-E, RAS-13YAV-E

P.M.V. : Pulse Modulating Valve

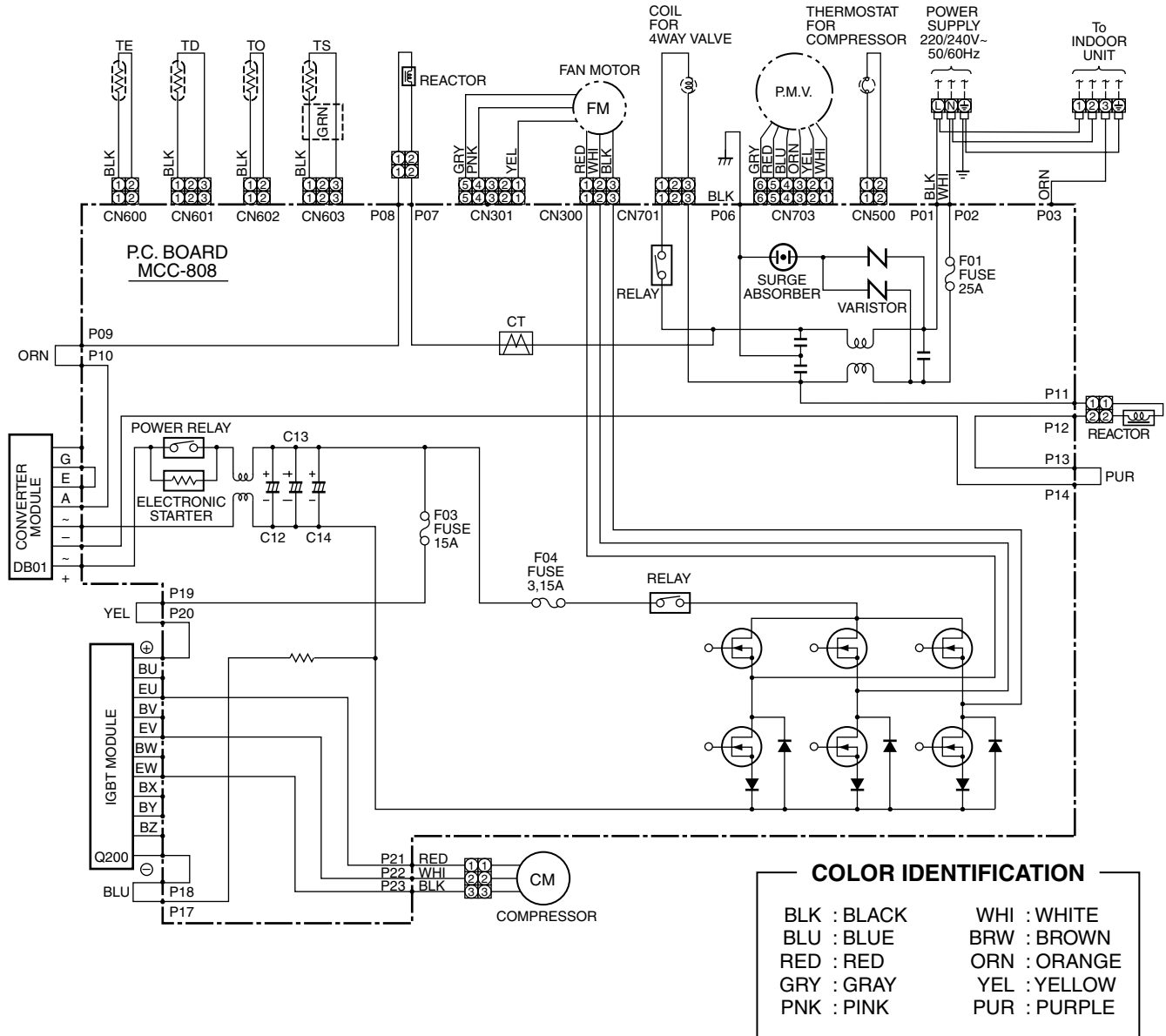

5. SPECIFICATIONS OF ELECTRICAL PARTS

5-1. Indoor Unit

RAS-10YKV-E, RAS-13YKV-E

No.	Parts name	Type	Specifications
1	Fan motor (for indoor)	TICF-35-19-4	DC35V, 19W
2	Thermo. sensor (TA-sensor)	(-)	10kΩ at 25°C
3	DC-DC transformer (T01)	SWT-34 or SWT-46	DC390V, Secondary DC35V, 12V, 7V
4	Microcomputer	TMP87PM40AF or TMP87CM40AF	
5	Heat exchanger temp. sensor (TC-sensor)	(-)	10kΩ at 25°C
6	Line filter (L01)	UF-253Y0R7	25mH, AC0,7A
7	Diode (DB01)	RBV-406 or D3SBA60	4A, 600V
8	Capacitor (C02)	KMH450VNSN100M25B	100μF, 450V
9	Fuse (F01)	TSCR6,3A	T6,3A, 250V
10	Power supply IC (IC01)	MA2830-FJ	4A, 600V
11	Varistor (R21, R109)	15G561K	560V
12	Resistor (R01)	ERF-5TK5R6	5,6Ω, 5W
13	Louver motor	MP35EA7	Output (Rated) 2W, 10poles, 1phase DC12V

5-2. Outdoor Unit

RAS-10YAV-E, RAS-13YAV-E

No.	Parts name	Model name	Rating	
1	SC coil (Noise filter)	L03	SC-15-S06J	15A, 0,6mH
		L01	SC-20-01J	20A, 150μH
2	DC-DC transformer	SWT-43	Primary side DC280V, Secondary side 7,5V x 1, 13V x 1, 26,5V x 3, 16V x 1, 15V x 1	
3	Reactor	CH38Z-K	L=10mH, 16A x 2	
4	Outside fan motor	ICF-140-40-7	DC140V, 40W	
5	Fan control relay	AJQ1341	Coil DC12V Contact AC125V, 3A	
6	Suction temp. sensor (TS sensor)	(Inverter attached)	10kΩ (25°C)	
7	Discharge temp. sensor (TD sensor)	(Inverter attached)	62kΩ (20°C)	
8	Outside air temp. sensor (TO sensor)	(Inverter attached)	10kΩ (25°C)	
9	Heat exchanger temp. sensor (TE sensor)	(Inverter attached)	10kΩ (25°C)	
10	Terminal block (9P)	—	20A, AC250V	
11	Fuse	For protection of switching power source	3,15A, AC250V	
		For protection of transistor module breakage	15A, AC250V	
		For protection of inverter input overcurrent	25A, AC250V	
12	Electrolytic capacitor	LLQ2G501KHUATF, 400LISN500K35F	500μF, DC400V X 3 pieces	
13	Transistor module	6MBI25GS-060-01 or 6MBI25GS-060-01A	25A, 600V	
14	Compressor	DA91A1F-44F	3-phases 4-poles 750W	
15	Compressor thermo.	US-622KXTMQO-SS	OFF: 125 ± 4°C, ON: 90 ± 5°C	
16	Converter module	MP7003	Diode: 25A, 600V, IGBT: 40A, 600V	

6. REFRIGERANT CYCLE DIAGRAM

6-1. Refrigerant Cycle Diagram

RAS-10YKV-E/RAS-10YAV-E
RAS-13YKV-E/RAS-13YAV-E

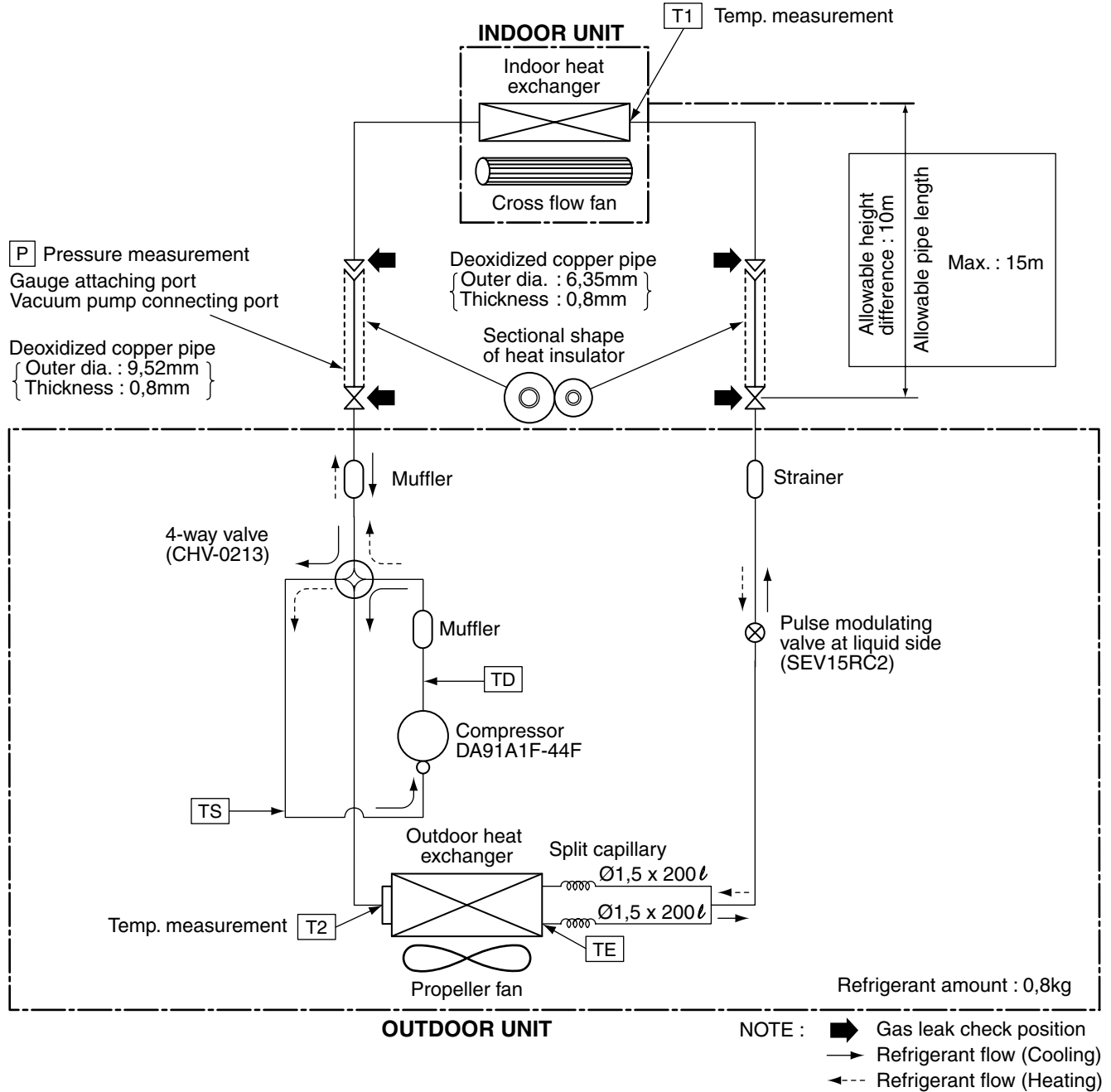

NOTE :

- The maximum pipe length of this air conditioner is 15 m. The additional charging of refrigerant is unnecessary because this air conditioner is designed with charge-less specification.

6-2. Operation Data

<Cooling>

Temperature condition (°C)		Model name	Standard pressure P (MPa)	Heat exchanger pipe temp.		Indoor fan mode	Outdoor fan mode	Compressor revolution (rps)
Indoor	Outdoor			T1 (°C)	T2 (°C)			
27/19	35/-	10YKV-E	0,8 to 1,0	9 to 11	42 to 44	High	High	56
		13YKV-E	0,8 to 1,0	8 to 10	46 to 48	High	High	85

<Heating>

Temperature condition (°C)		Model name	Standard pressure P (MPa)	Heat exchanger pipe temp.		Indoor fan mode	Outdoor fan mode	Compressor revolution (rps)
Indoor	Outdoor			T1 (°C)	T2 (°C)			
20/-	7/6	10YKV-E	3,5 to 3,7	42 to 44	2 to 4	High	High	70
		13YKV-E	2,5 to 2,7	50 to 52	0 to 3	High	High	97

NOTES :

- (1) Measure surface temperature of heat exchanger pipe around center of heat exchanger path U bent.
(Thermistor thermometer)
- (2) Connecting piping condition : 5 m

7. CONTROL BLOCK DIAGRAM

7-1. Indoor Unit

RAS-10YKV-E, RAS-13YKV-E

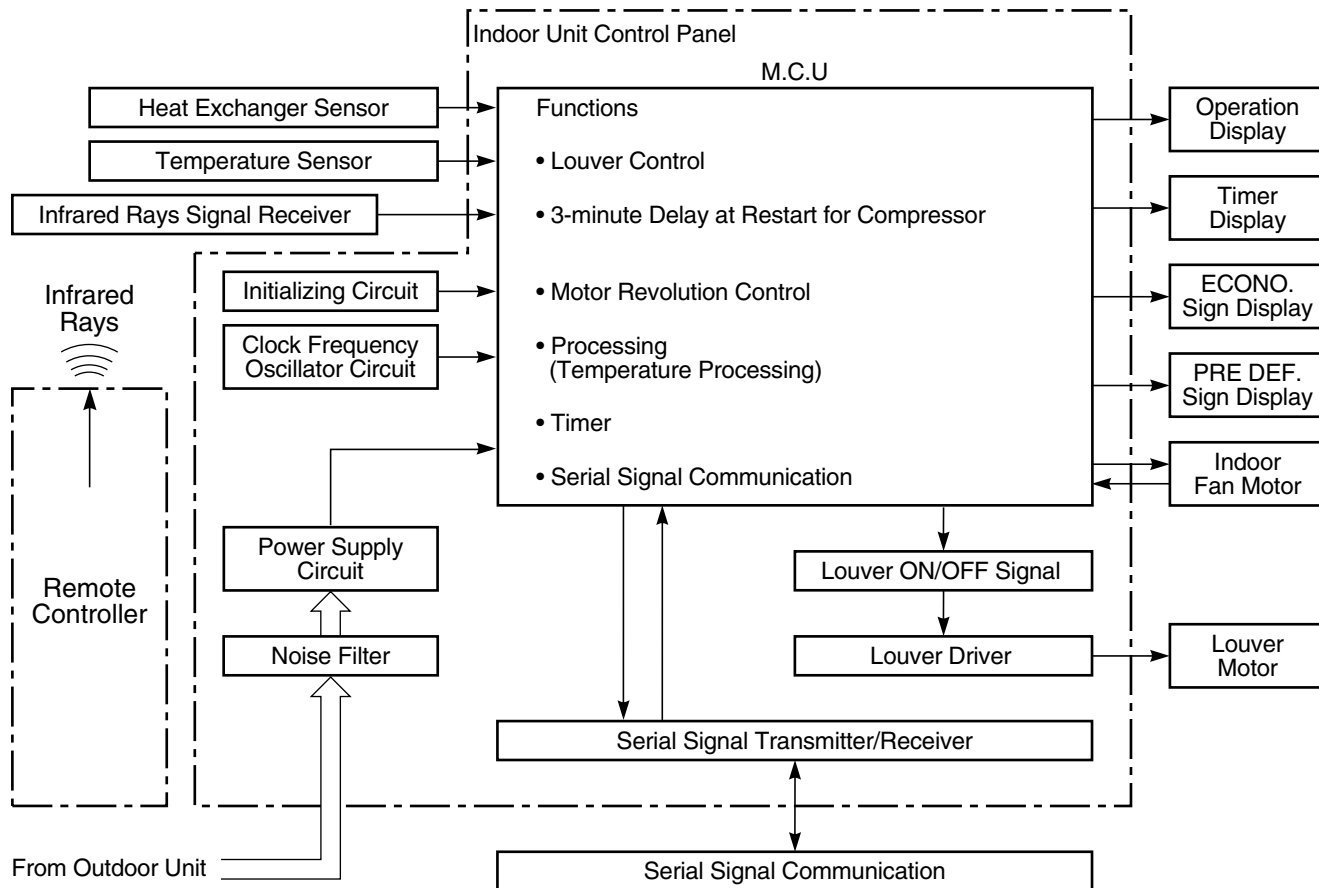

REMOTE CONTROLLER

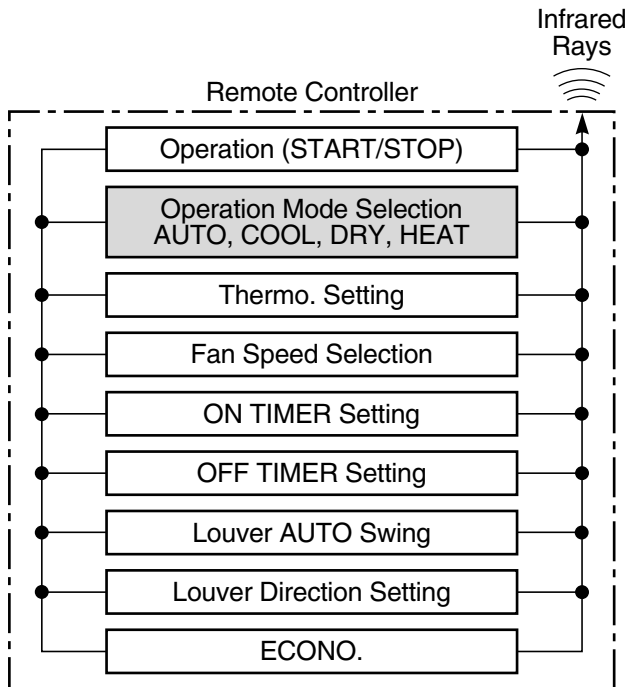

7-2. Outdoor Unit (Inverter Assembly)
RAS-10YAV-E, RAS-13YAV-E

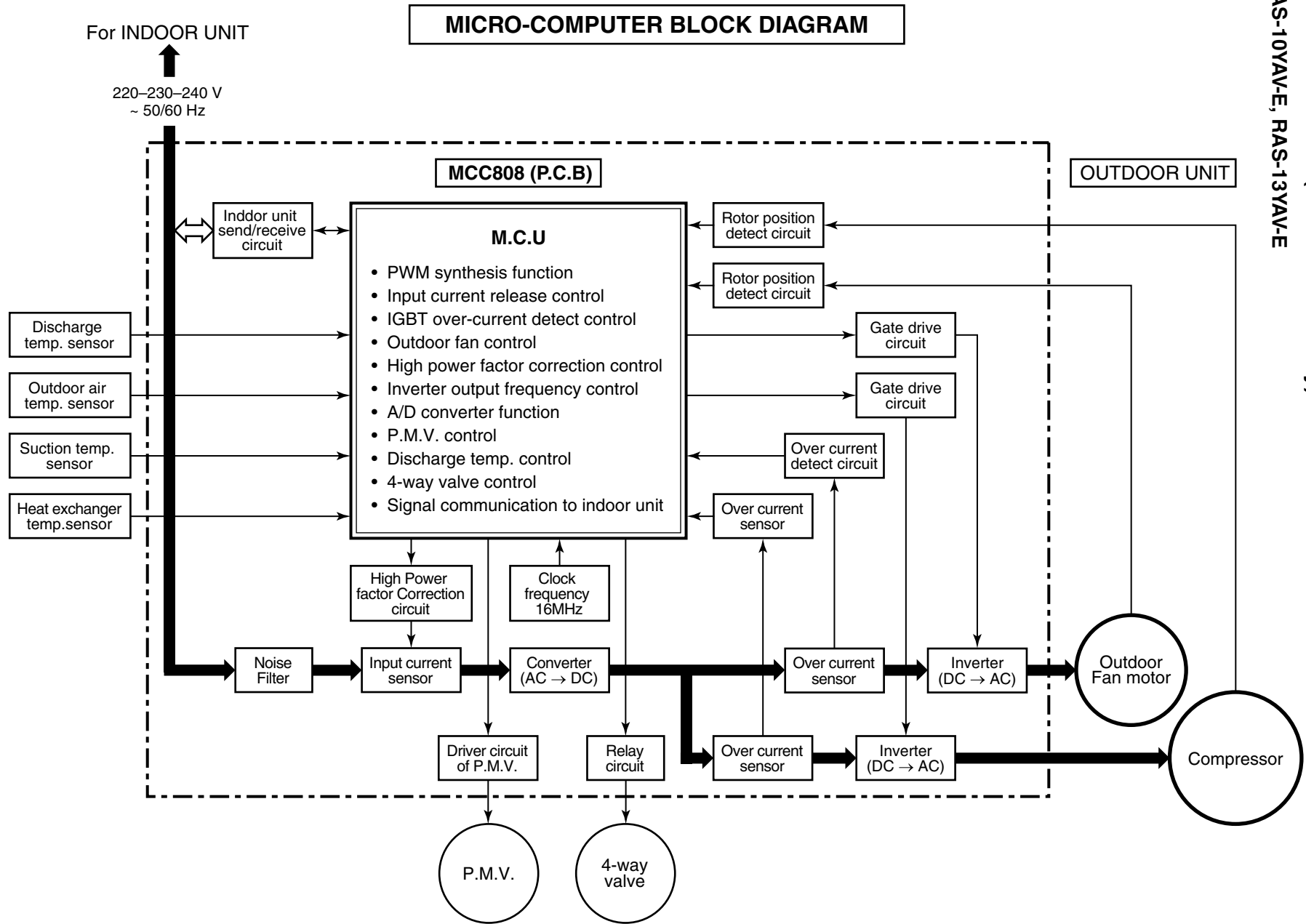

8. OPERATION DESCRIPTION

8-1. Outline of Air Conditioner Control

This air conditioner is a capacity-variable type air conditioner, which uses DC motor for the indoor fan motor and the outdoor fan motor. And the capacity-proportional control compressor which can change the motor speed in the range from 13 to 120 rps is mounted. The DC motor drive circuit is mounted to the indoor unit. The compressor and the inverter to control fan motor are mounted to the outdoor unit. The entire air conditioner is mainly controlled by the indoor unit controller.

The indoor unit controller drives the indoor fan motor based upon command sent from the remote controller, and transfers the operation command to the outdoor unit controller.

The outdoor unit controller receives operation command from the indoor unit side, and controls the outdoor fan and the pulse modulating valve. Besides, detecting revolution position of the compressor motor, the outdoor unit controller controls speed of the compressor motor by controlling output voltage of the inverter and switching timing of the supply power (current transfer timing) so that motors drive according to the operation command. And then, the outdoor unit controller transfers reversely the operating status information of the outdoor unit to control the indoor unit controller.

As the compressor adopts four-pole brushless DC motor, the frequency of the supply power from inverter to compressor is two-times cycles of the actual number of revolution.

(1) Role of indoor unit controller

The indoor unit controller judges the operation commands from the remote controller and assumes the following functions.

- Judgment of suction air temperature of the indoor heat exchanger by using the indoor temp. sensor.
- Temperature setting of the indoor heat exchanger by using heat exchanger sensor (Prevent-freezing control)
- Louver motor control
- Indoor fan motor operation control
- LED display control
- Transferring of operation command signal (Serial signal) to the outdoor unit
- Reception of information of operation status (Serial signal including outside temp. data) to the outdoor unit and judgment/display of error

(2) Role of outdoor unit controller

Receiving the operation command signal (Serial signal) from the indoor controller, the outdoor unit performs its role.

- Compressor operation control
 - Operation control of outdoor fan motor
 - P.M.V. control
- } Operations followed to judgment of serial signal from indoor side.
- Detection of inverter input current and current release operation
 - Over-current detection and prevention operation to transistor module (Compressor stop function)
 - Compressor and outdoor fan stop function when serial signal is off (when the serial signal does not reach the board assembly of outdoor control by trouble of the signal system)
 - Transferring of operation information (Serial signal) from outdoor unit to indoor unit
 - Detection of outdoor temperature and operation revolution control
 - Defrost control in heating operation (Temp. measurement by outdoor heat exchanger and control for four-way valve and outdoor fan)

- (3) Contents of operation command signal (Serial signal) from indoor unit controller to outdoor unit controller

The following three types of signals are sent from the indoor unit controller.

- Operation mode set on the remote control
- Compressor revolution command signal defined by indoor temperature and set temperature (Correction along with variation of room temperature and correction of indoor heat exchanger temperature are added.)
- For these two types of signals ([Operation mode] and [Compressor revolution]), the outdoor unit controller monitors the input current to the inverter, and performs the followed operation within the range that current does not exceed the allowable value.
- Temperature of indoor heat exchanger by indoor heat exchanger sensor (Minimum revolution control)

- (4) Contents of operation command signal (Serial signal) from outdoor unit controller to indoor unit controller

The following signals are sent from the outdoor unit controller.

- The current operation mode
- The current compressor revolution
- Outdoor temperature
- Existence of protective circuit operation

For transferring of these signals, the indoor unit controller monitors the contents of signals, and judges existence of trouble occurrence.

Contents of judgment are described below.

- Whether distinction of the current operation status meets to the operation command signal
- Whether protective circuit operates

When no signal is received from the outdoor unit controller, it is assumed as a trouble.

8-1-1. Capacity Control

The cooling and heating capacity is varied by changing compressor motor speed. The inverter changes compressor motor speed by changing AC 220–230–240V power to DC once, and controls capacity by changing supply power status to the compressor with transistor module (includes 6 transistors). The outline of the control is as follows: The revolution position and revolution speed of the motor are detected by detecting winding electromotive force of the compressor motor under operation, and the revolution speed is changed so that the motor drives based upon revolution speed of the operation command by changing timing (current transfer timing) to exchange inverter output voltage and supply power winding.

Detection of the revolution position for controlling is performed 12 times per 1 revolution of compressor. The range of supply power frequency to the compressor differs according to the operation status (COOL, HEAT, DRY).

Table 8-1-1 Compressor revolution range

Operation mode	Model name	Compressor revolution (rps)
COOL	10YKV-E	13 to 74
	13YKV-E	13 to 94
HEAT	10YKV-E	16 to 110
	13YKV-E	16 to 114

8-1-2. Current Release Control

The outdoor main circuit control section (Inverter assembly) detects the input current to the outdoor unit. If the current value with compressor motor speed instructed from indoor side exceeds the specified value, the outdoor main circuit control section controls compressor motor speed by reducing motor speed so that value becomes closest to the command within the limited value.

8-1-3. Power Factor Improvement Control

Power factor improvement control is performed mainly aiming to reduce the current on much power consumption of cooling/heating operation. Controlling starts from the time when input power has reached at a certain point. To be concrete, IGBT of the power factor improvement circuit is used, and the power factor is improved by keeping IGBT on for an arbitrary period to widen electro-angle of the input current.

8-1-4. Prevent-Freezing Control

The indoor heat exchanger sensor detects refrigerant vapor temperature in COOL/DRY operation. If the temperature is below the specified value, compressor motor speed is reduced so that operation is performed in temperature below the specified value to prevent-freezing of indoor heat exchanger.

8-1-5. P. M. V. (Pulse Modulating Valve)

Using P.M.V., refrigerant flow of refrigeration cycle is varied for the optimum temperature. Controlling each unit separately by two P.M.V. corresponds to difference of pipe length, fan speed, and unit temperature.

After the power has been turned on, when a serial operation signal is received from indoor at the first time, or when PMV alarm is detected and the equipment is reactivated, move the valve once until it hits on the stopper for positioning of the valve. In this case, ticktack sound may be heard.

8-1-6. Louver Control

(1) Vertical air flow louvers

Positions of vertical air flow louvers are automatically controlled according to the operation status (AUTO, COOL, DRY, HEAT). Besides, positions of vertical air flow louvers can be arbitrarily set by pressing the [SET] button.

The louver position which has been set by the [SET] button is stored in microcomputer, and the louver is automatically set at the stored position in the next operation.

(2) Swing

If the [AUTO] button is pressed during running operation, vertical air flow louvers start swinging. When the [AUTO] button is pressed again, swinging stops.

8-1-7. Indoor Fan Control (DC Fan Motor)

The indoor fan is operated by motor speed non-step variable DC drive system motor. For flow rate, motor speed is controlled manually in three steps (LOW, MED, HIGH), and with the unit of 10 rpm from upper limit to lower limit in AUTO mode as described in Table 8-1-2. It is not selected by relay, so selecting sound does not generate.

Table 8-1-2

Operation mode	Fan mode	RAS-10YKV-E		RAS-13YKV-E	
		Motor speed (rpm)	Air flow rate (m ³ /h)	Motor speed (rpm)	Air flow rate (m ³ /h)
COOL	H	1120	480	1210	530
	M	980	400	1020	420
	L	850	330	850	330
DRY	—	820	320	820	320
HEAT	H	1200	520	1270	560
	M	1070	450	1100	470
	L	930	380	930	380

8-1-8. Outdoor Fan Control (DC Fan Motor)

Although the outdoor fan motor drives the outdoor fan by non-step variable system of the revolution speed, the revolution speed is restricted to three steps on the convenience of controlling. If a strong wind is lashing outside of the room, the operation may be continued as the outdoor fan stops in order to protect the outdoor fan motor.

If a fan lock occurred due to entering of foreign matter, the air conditioner stops and an alarm is displayed.

<COOL, DRY>

Table 8-1-3

Model name		RAS-10YAV-E			RAS-13YAV-E		
Compressor revolution (rps)		To 13,2	To 34,1	From 34,7	To 13,2	To 34,1	From 34,7
Outdoor temp. sensor TO	TO ≥ 38°C	450	800	800	450	940	940
	TO < 38°C	450	630	800	450	700	940
	TO < 15°C	390			390		
ECONO. operation	TO ≥ 38°C	450	630	800	450	700	940
	TO < 38°C	450	450	630	450	450	700
	TO < 15°C	390			390		
TO is abnormal		630	630	800	700	700	940

<HEAT>

Table 8-1-4

Model name		RAS-10YAV-E			RAS-13YAV-E		
Compressor revolution (rps)		To 16,2	To 44,3	From 44,9	To 16,2	To 44,3	From 44,9
Outdoor temp. sensor TO	TO ≥ 5°C	390	580	800	390	650	900
	TO < 5°C	580	580	800	650	650	940
ECONO. operation	TO ≥ 5°C	390	390	580	390	390	650
	TO < 5°C	390	580	580	390	650	650
TO is abnormal		390	580	800	390	650	900

8-2. Description of Operation Circuit

- Turning [ON] the breaker flashes the operation lamp.
This is the display of power-ON (or notification of power failure).
- When pushing [START/STOP] button of the remote control, receive sound is issued from the main unit, and the next operations are performed together with opening the vertical air flow louvers.

8-2-1. Cooling Operation (The Remote Controller MODE Button is Set to the COOL Position)

- Once the setting is made, the operation mode is memorized in the microcomputer so that the same operation can be effected thereafter simply by pushing [START/STOP] button.
- A cooling operation signal is transmitted to outdoor unit.
- The indoor fan motor operates as shown in Fig. 8-2-1 when FAN button is set to AUTO.
- The motor operates with a constant air flow when the FAN button is set to LOW, MED, or HIGH.
- The outdoor unit controls the outdoor fan relay R01, R02 and R03, and the compressor motor speed according to the operation command signal sent from the indoor unit.

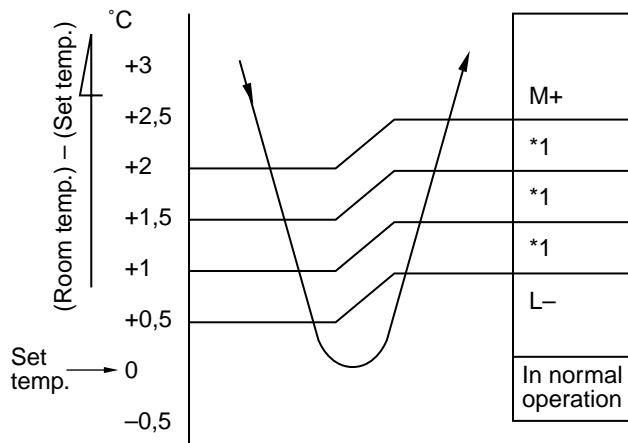

NOTE :

- *1: Calculated from difference in motor speed of M+ and L-, and controlled.

Fig. 8-2-1 Setting of air flow [Fan AUTO]

(1) Cooling capacity control

- The cooling capacity and room temperature are controlled by changing the compressor motor speed according to both the difference between the temperature detected by the room temperature sensor and the temperature set by TEMP button and also any change in room temperature.
- When compressor has been activated or reactivated, it operates with Max. 41 rps for 2 minutes, with Max. 91 rps from 2 minute to 3 minutes, and with Max. 94 rps after 3 minutes passed.
- When room temperature is lower than set temperature, indoor fan motor is operated at fan speed L- as shown in Fig. 8-2-1 while the outdoor unit stops.

(2) Prevent-freezing control

If temperature of indoor heat exchanger detected by the indoor heat exchanger sensor is 5°C or lower, compressor motor speed is gradually lowered to prevent freezing of the indoor heat exchanger. If temperature is 7°C or higher, return the operation to the above item (1).

(3) Current release control

The input current of compressor and outdoor fan motor (Precisely inverter main circuit control section) which occupy most of air conditioner input is detected by the outdoor current sensor, and compressor motor speed is gradually lowered so that current value does not exceed 9,0A if current value exceeds 9,0A. When the current value lowers to 8,5A, return the operation to the above item (1).

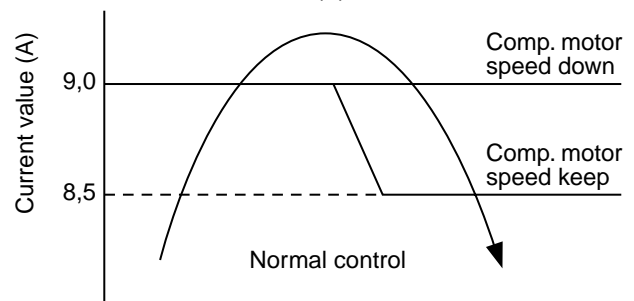

Fig. 8-2-2

(4) Outdoor temperature release control

The outdoor temperature release is controlled by changing the current release points 9,0 and 8,5 in the above item according to temperature detected by the outdoor temperature sensor.

For example, if the outdoor temperature is 43°C, the value of current release point becomes 8,0A.

(5) Limit for maximum compressor motor speed by indoor fan speed

When outdoor temperature sensor detected 32°C or lower, and indoor heat exchanger sensor detected 17°C or lower, the maximum compressor motor speed is limited by the indoor fan speed.

For example, the compressor motor speed is limited as described in the table below.

Table 8-2-1

Air flow rate	RAS-10YKV-E (rps)	RAS-13YKV-E (rps)
HIGH	56	85
M+	49	71
MED.	43	57
L-, L	36	44
UL, SUL	30	30

(6) Louver control

The vertical air flow louvers are automatically set to horizontal or cool memory position.

When temperature of indoor heat exchanger becomes 5°C or lower by the prevent-freezing control and the compressor is turned off, the vertical air flow louvers close once and then return to the position of previous time.

(7) Discharge temperature control (Common control to cooling and heating)

The discharge temperature of refrigerant gas from the compressor is detected by the discharge temperature sensor, and controls operating compressor motor speed.

- 1) Control 1 (A zone) : Normal operation zone
When TD detect value is 98°C or lower, the operation is performed with operating motor speed instructed by the serial signal.
- 2) Control 2 (B zone) : Slow-up zone of motor speed
When TD detect value is 98°C or higher, operating motor speed is slowly up.
- 3) Control 3 (C zone) : Keep zone
When TD detect value is 105°C or higher, operating motor speed is not changed if raising operation speed.
- 4) Control 4 (D zone) : Slow down zone of motor speed
When TD detect value is 108°C or higher, operating motor speed is slowly down.
- 5) Control 5 (E zone) : Normal down of motor speed
When TD detect value is 112°C or higher, operating motor speed is down.
- 6) Control 6 (F zone) : Operation stop zone
If TD detect value exceeds 117°C during operation, stop the operation immediately. Then, restart the operation when TD detect value becomes 105°C or lower.

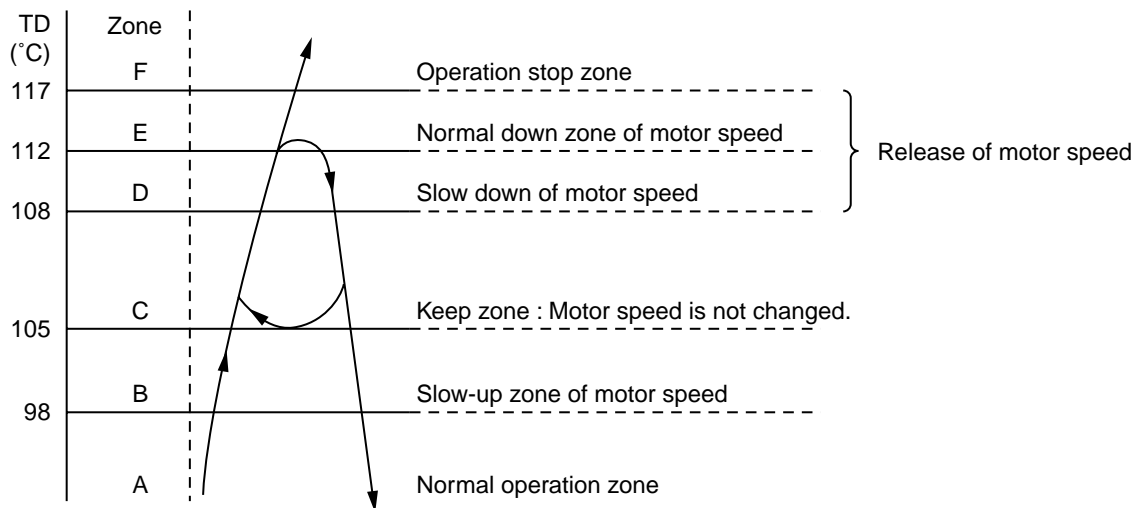

Fig. 8-2-3 Compressor motor speed control

(8) ECONO. operation control

When the ECONO. button of the remote controller is pushed, quiet and mild operation is performed by restraining air flow and operating motor speed.

1) Indoor air flow is controlled between SUL and L- (Low air (-)).

2) Setting 10 at 16 rps and 13 at 20 rps as the maximum operating compressor motor speed, the minimum capacity operation range is widened every 1 hour and 2 hours have passed after ECONO. operation had started.

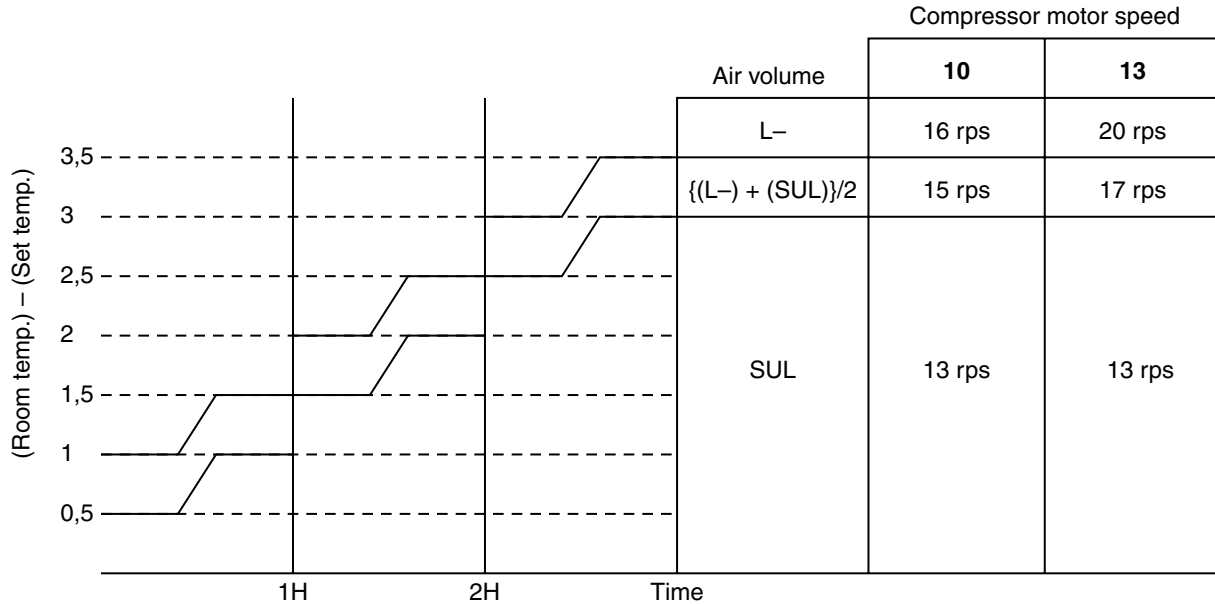
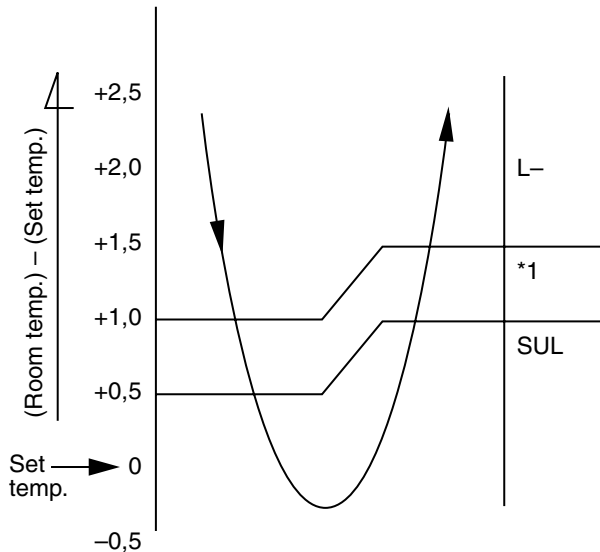

Fig. 8-2-4

**8-2-2. DRY Operation
(The Remote Controller MODE Button is Set to the DRY Position)**

- Once the setting is made, the operation mode is memorized in the microcomputer so that the same operation can be effected thereafter simply by pushing [START/STOP] button.
- Dry operation signal is transmitted to outdoor unit.
- The Cooling operation giving priority to dehumidifying, which restrains the indoor fan speed and compressor motor speed, is performed.
- The indoor fan motor operates as shown in Fig. 8-2-5. (Fan speed is AUTO only.)
- The outdoor unit controls the outdoor fan relay R01, R02 and R03, and the compressor motor speed according to the operation command signal sent from the indoor unit.



NOTE :

*1 : Middle motor speed between L- and SUL

Fig. 8-2-5 Setting of air flow

8-2-3. Heating Operation

Transferring of heating operation signal from indoor unit to outdoor unit starts.

The indoor fan motor operates by the room temperature when selecting "AUTO" of "FAN" as shown in Fig. 8-2-6, and operates with a set air flow when selecting "Low" to "High".

However, to prevent cold draft, revolution speed of the fan is restricted by indoor heat exchanger when air flow is AUTO (Fig. 8-2-7) and starting of FAN Manual.

[Basic control]

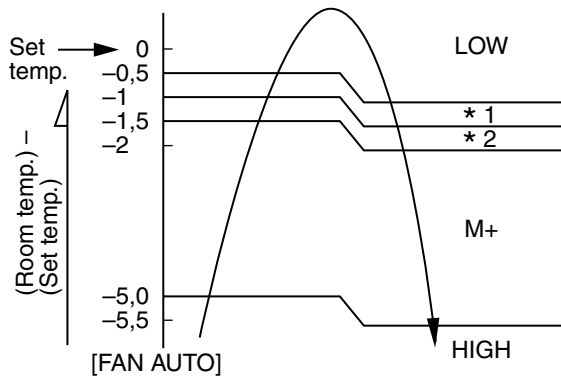

*1, *2 : Approximate revolution speed of M+ and L to linear according to temperature.

Fig. 8-2-6 Setting of air flow

[Cold draft preventing control]

The upper limit of fan revolution speed is shown below.

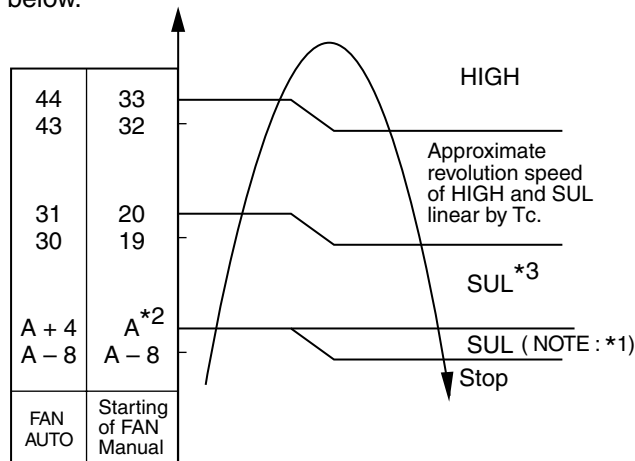

Fig. 8-2-7 Cold draft preventing control

NOTES :

- (1) Stops for 2 minutes after thermostat-OFF.
- (2) 24°C when the set temp. is 24°C or more
Set temp. when the set temp. is below 24°C
- (3) SUL : Super ultra low

[In starting and in stability]

	In starting	In stability
FAN AUTO	<ul style="list-style-type: none"> • Until 12 minutes passed after operation start • When 12 to 25 minutes passed after operation start and room temp. is 3°C or lower than set temp. 	<ul style="list-style-type: none"> • When 12 to 25 minutes passed after operation start and room temp. is higher than (set temp. -3°C) • When 25 minutes or more passed after operation start
FAN Manual	<ul style="list-style-type: none"> • Room temp. < Set temp. -4°C 	<ul style="list-style-type: none"> • Room temp. ≥ Set temp. -3,5°C

The outdoor unit controls the outdoor fan based upon the operation signal sent from the indoor unit, and also controls revolution speed of the compressor motor.

The power coupler (IC20) for four-way valve is turned on, and turned off in defrost operation.

(1) Heating capacity control

Calculate the difference between temperature detected by room temp. sensor every minute and the set temp. set on "Temp. indicator" and variation amount of room temp.

Then, obtain the correction amount of the command signal, and correct the current frequency command signal.

(2) High-temp. release control

If temperature of the indoor heat exchanger detected by the indoor heat exchanger sensor is 55°C or higher, compressor motor speed is gradually lowered to prevent over-temp. rising of compressed pressure.

If temperature becomes below 48°C, return to above item (1).

(3) Current release control

The input current of compressor and outdoor fan motor (Precisely inverter main circuit control section) which occupy most of air conditioner input is detected by the outdoor current sensor. The compressor motor speed is lowered gradually according to the range of TO (outside air temp.) if the input current exceeds the current value determined in each zone as shown in Fig. 8-2-8 so that the input current does not exceed the set value.

In case that the current lowered by approx. 0,5A than each set value, return to above item (1).

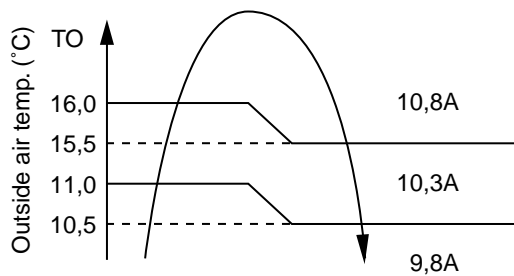

Fig. 8-2-8

(4) Defrost control

1) Detection of frost

In heating operation, time duration while the compressor operates is counted, and defrost operation starts by any condition described below.

- a. The counted time is 28 minutes or more, and status that temperature of the outdoor heat exchanger detected by the outdoor heat exchanger is -20°C or lower continued for 2 minutes or more.
- b. The counted time is 28 minutes or more, and status that temperature of the outdoor heat exchanger detected by the outdoor heat exchanger is -7°C or lower and temperature lowered by $2,5^{\circ}\text{C}$ than the minimum value of the outdoor heat exchanger during 10 to 15-minutes count time continued for 2 minutes or more.
- c. The counted time is 34 minutes or more, and status that temperature of the outdoor heat exchanger detected by the outdoor heat exchanger is -5°C or lower and temperature lowered by $3,0^{\circ}\text{C}$ than the minimum value of the outdoor heat exchanger during 10 to 15-minutes count time continued for 2 minutes or more.
- d. If the following three conditions are satisfied, defrost operation (Timer defrost) starts after heating operation for 37 minutes.
 - ① Setting on remote control, HEAT (mode), HIGH (Fan), 30°C (temp.).
 - ② Room temp. is 19°C to 24°C , and outside air temp. is 5°C or lower.
 - ③ Defrost operation has been already performed once.

2) Defrost operation

Operation of the compressor is stopped once, turn off power coupler for four-way valve after 10 seconds, and then exchange the four-way valve.

After 20 seconds, restart operation of the compressor. Turn off the outdoor fan just when the compressor stopped.

If temperature of the indoor heat exchanger lowered than 38°C , stop the indoor fan.

3) Defrost reset

Resetting operation from defrost to heating is performed when any one of the following conditions is satisfied.

- a. Temperature of the outdoor heat exchanger rose to $+8^{\circ}\text{C}$ or higher.
- b. A status that temperature of the outdoor heat exchanger is $+5^{\circ}\text{C}$ or higher continued for 80 seconds.
- c. Defrost operation continued for 10 minutes.

In resetting defrost operation, the compressor stops for 50 seconds if defrost has started under condition a. to c. in item 1), but the compressor is reset to heating operation keeping operated if defrost has started under condition d. in item 1).

(5) Louver control

The vertical air flow louvers are automatically set to heating position or heat memory position. When the compressor is turned off by high-temp. release control, the vertical air flow louvers close once and then return to the position of previous time.

8-2-4. Automatic Operation

(1) As shown in Fig. 8-2-9, the operation mode (COOL, DRY, HEAT) is selected according to the outside temperature and room temperature when the operation has started.

The operation in Fan mode continues until an operation mode is selected.

If the room temperature is 20°C or higher when "AUTO" operation started within 2 hours after "HEAT" operation had stopped, select an operation mode after Fan operation of ultra low fan.

In AUTO operation, the set temperature of each operation can be corrected by the remote controller in the range of 17 to 30°C.

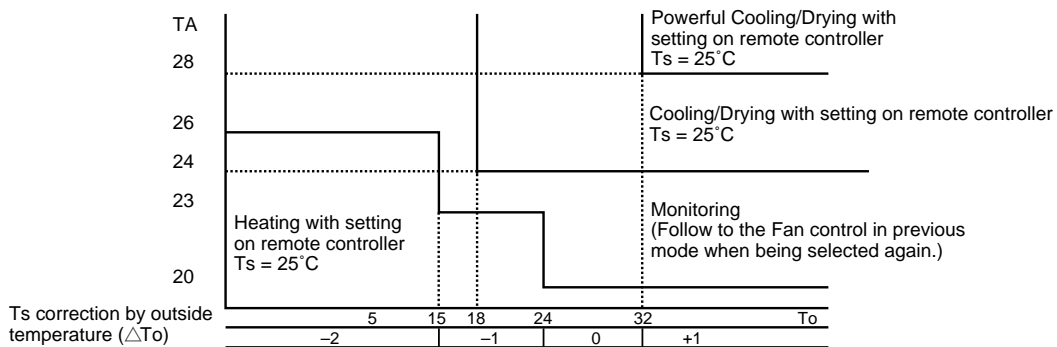

Fig. 8-2-9

8-3. Temporary Operation

- Temporary Auto operation, existence of Auto Restart, and Temporary Cooling operation can be set by the TEMPORARY button of the indoor controller.

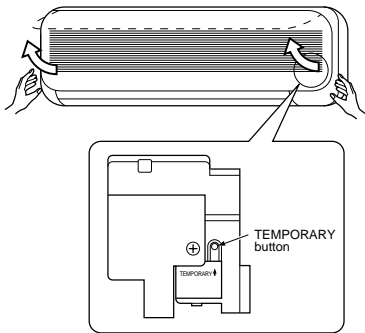

Table 8-3-1

TEMPORARY button	Control
OFF → ON	Temporary Auto operation start
After pushing button for 3 seconds	Auto Restart control select
After pushing button for 10 seconds	Temporary Cooling operation start

(2) After selecting the operation mode (COOL, DRY, HEAT), select an operation mode again when a status that the compressor was turned off by the room temperature or outside air temperature continues for 15 minutes.

(3) Powerful Cool mode control

When the outside temperature is above 32°C and indoor temperature is above 28°C, select Cool mode control. In Cool mode, the air flow louver directs downward. When the room temperature gains access to the set temperature, it becomes cool memory position.

8-3-1. Temporary Auto Operation

- When the TEMPORARY button is pushed, the Auto operation with set temperature fixed at 25°C starts. Controlling is same as that of Auto operation by the remote controller.
- When the TEMPORARY button is pushed again, the operation stops.
- During Temporary Auto operation, operation by the remote controller is accepted.
- Using the Auto Restart function, the Temporary Auto operation starts when power failure is reset.

8-3-2. Temporary Cooling Operation

- When the TEMPORARY operation button keeps pushed for 10 seconds, Cooling operation of which compressor motor speed and the indoor fan speed are fixed starts.

Compressor motor speed :

10 : 30 rps

13 : 30 rps

Indoor fan speed : Low

- When the TEMPORARY operation button is pushed again, the operation stops.
- Auto Restart function is unavailable.

8-4. Auto Restart Function

This unit is equipped with an Automatic restarting facility which allows the unit to restart and resume the set operating conditions in the event of a power supply shutdown without the use of the hand control.

The operation will resume without warning three minutes after the power is restored.

The Auto Restart function is set not to work on shipment from the factory, and so it is necessary to set it to function as required.

8-4-1. How to Set the Auto Restart

To set the Auto Restart function, proceed as follows:

Access the TEMPORARY button located in the lower right hand corner beneath the hinged front panel of the indoor unit (please refer to Fig. 8-2-9). The power supply to the unit must be on - the function will not be set if the power is off.

To enable the Auto Restart function, push the TEMPORARY button continuously for three seconds.

The unit will acknowledge the setting and beep three times. The system will now restart automatically.

The above Auto Restart settings can be carried out:

- When the system is stand-by (not operating)

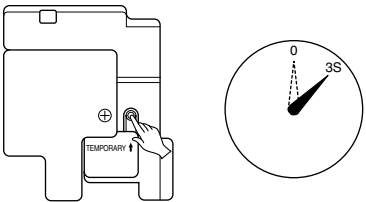
Operation	Motion
<p>Push the TEMPORARY button continuously more than three seconds.</p> 	<p>Stand-by ↓ The system starts to operate. The green light goes on. ↓ about three seconds after The unit beeps three times. The orange light goes on. ↓ The system is operating. If the system is not required to run at this time, push the TEMPORARY button once more or use the remote controller and the unit will stop.</p>

- When the system is operating

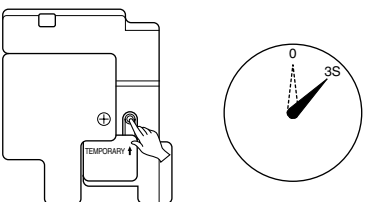
Operation	Motion
<p>Push the TEMPORARY button continuously more than three seconds.</p> 	<p>Operating The green light goes on. ↓ The system stops to operate. The green light goes off. ↓ about three seconds after The unit beeps three times. ↓ The system stops. If the system is not required to stop at this time, use the remote controller and to restart.</p>

During subsequent operation, the orange light goes on.

- The Auto Restart function will not accept an instruction if timer operation with the remote controller is selected.

- During louver swing (AUTO) operation, after restart by the Auto Restart function the louver swing stops.

8-4-2. How to Cancel the Auto Restart

To cancel the Auto Restart function, proceed as follows:

Repeat the setting procedure: the unit will acknowledge the instruction and beep three times.

The system will now be required to manually restart with the remote controller after the main supply is turned off.

Cancellation is carried out:

- When the system is stand-by (not operating)

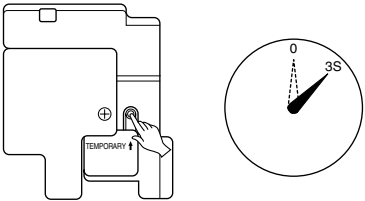
Operation	Motion
<p>Push the TEMPORARY button continuously more than three seconds.</p> 	<p>Stand-by ↓ The system starts to operate. The orange light goes on. ↓ about three seconds after The unit beeps three times. The green light goes on. ↓ The system is operating. If the system is not required to run at this time, push the TEMPORARY button once more or use the remote controller and the unit will stop.</p>

- When the system is operating

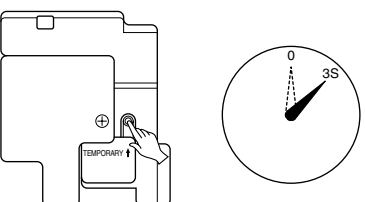
Operation	Motion
<p>Push the TEMPORARY button continuously more than three seconds.</p> 	<p>Operating The orange light goes on. ↓ The system stops to operate. The orange light goes off. ↓ about three seconds after The unit beeps three times. ↓ The system stops. If the system is not required to stop at this time, use the remote controller and to restart.</p>

During subsequent operation, the green light goes on.

8-4-3. In Case of Power Failure during the Timer Operation

(1) If ON-TIMER operation is reserved with setting of Auto Restart operation, it is cancelled with power failure. (The OPERATION lamp on the main unit goes on and off to inform of power failure.) In that case, try to reserve ON-TIMER operation once again.

(2) If OFF-TIMER operation is reserved without setting of Auto Restart operation, the reservation is cancelled with power failure. (The OPERATION lamp on the main unit goes on and off to inform of power failure.) In that case, try to reserve OFF-TIMER operation. When Auto Restart operation is set, OFF-TIMER reservation is also cancelled with power failure.

8-5. Remote Controller

8-5-1. Parts Name of Remote Controller

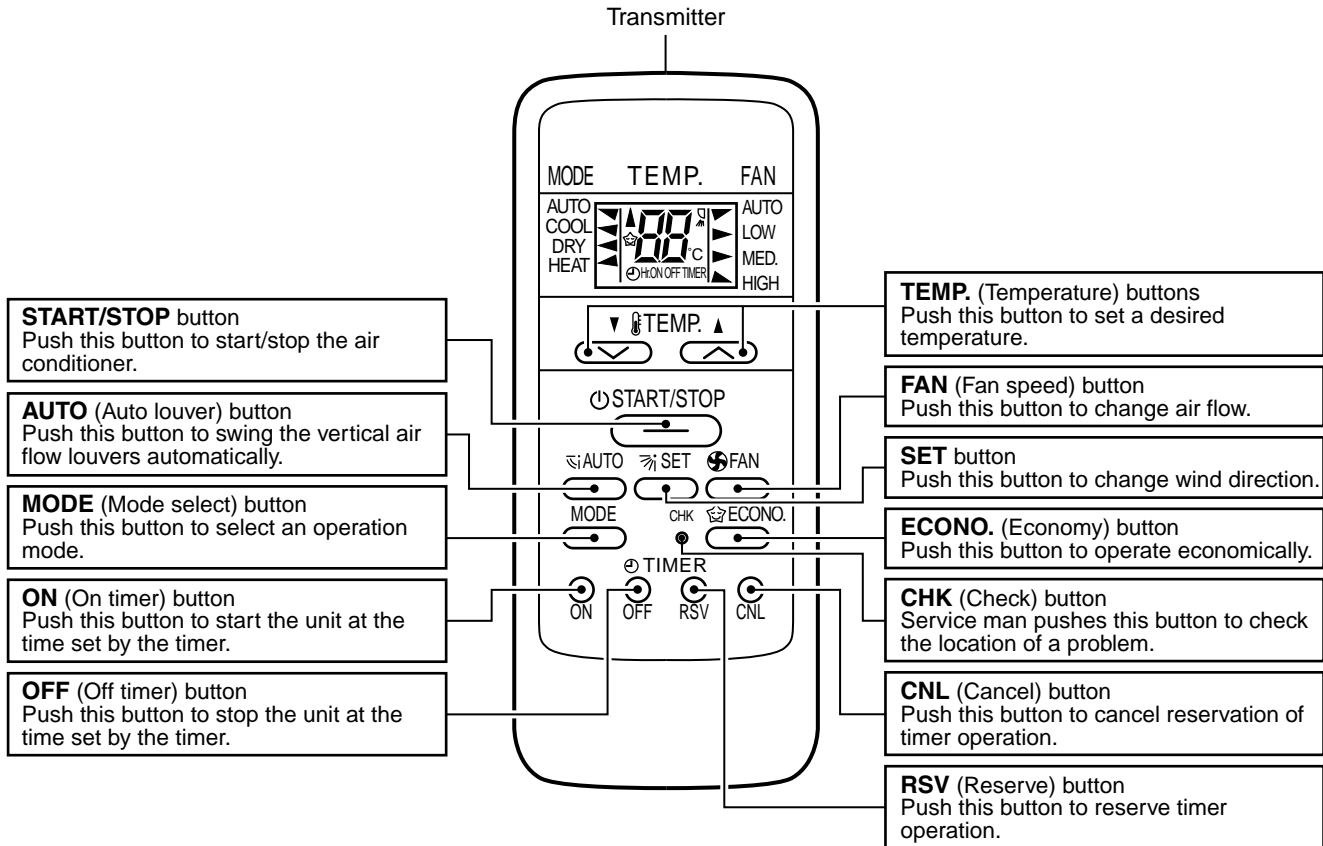

8-5-2. Name of Indications on Remote Controller

All indication that appear on the remote controller are shown for explanation.

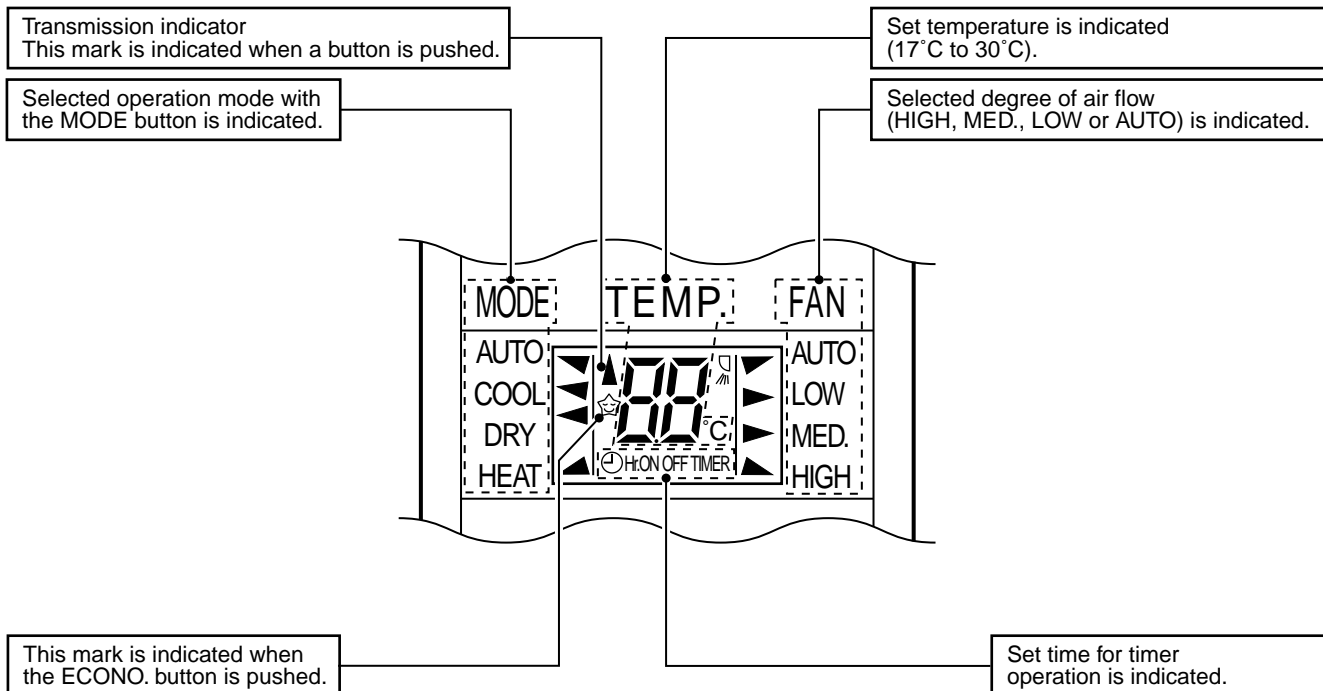

9. INSTALLATION PROCEDURE

9-1. Safety Cautions

CAUTION

New Refrigerant Air Conditioner Installation

- This air conditioner adopts the new HFC refrigerant (R410A) which does not destroy ozone layer. R410A refrigerant is apt to be affected by impurity such as water, oxidizing membrane, and oils because pressure of R410A refrigerant is approx. 1.6 times of refrigerant R22. Accompanied with adoption of the new refrigerant, refrigerating machine oil has been also changed. Therefore, during installation work, be sure that water, dust, former refrigerant, or refrigerating machine oil does not enter into the refrigerating cycle of new-refrigerant air conditioner.
- To prevent mixing of refrigerant or refrigerating machine oil, the sizes of connecting sections of charging port of the main unit or installation tools are different from those for the conventional refrigerant. Accordingly, the exclusive tools are required for the new refrigerant (R410A) as shown below.
- For connecting pipes, use new and clean piping materials with high pressure-tight force, which were made for R410A only, so that water or dust does not enter. Moreover, do not use the existing piping because there are problems about pressure-tight force and inner impurity in the existing piping.

CAUTION

To Disconnect the Appliance from the Mains Supply.

- This appliance must be connected to the mains by means of a circuit breaker or a switch with a contact separation of at least 3 mm.
- If this is not possible, a power supply plug with earth must be used. This plug must be easily accessible after installation. The plug must be disconnected from the power supply socket in order to disconnect the appliance completely from the mains.

DANGER

- FOR USE BY QUALIFIED PERSONS ONLY.
- TURN OFF MAIN POWER SUPPLY BEFORE ATTEMPTING ANY ELECTRICAL WORK. MAKE SURE ALL POWER SWITCHES ARE OFF. FAILURE TO DO SO MAY CAUSE ELECTRIC SHOCK.
- CONNECT THE CONNECTING CABLE CORRECTLY. IF THE CONNECTING CABLE IS CONNECTED BY WRONG WAY, ELECTRIC PARTS MAY BE DAMAGED.
- CHECK THE EARTH WIRE IS NOT BROKEN OR DISCONNECTED BEFORE INSTALLATION.
- DO NOT INSTALL NEAR CONCENTRATIONS OF COMBUSTIBLE GAS OR GAS VAPORS. FAILURE TO FOLLOW THIS INSTRUCTION CAN RESULT IN FIRE OR EXPLOSION.
- TO PREVENT OVERHEATING THE INDOOR UNIT AND CAUSING A FIRE HAZARD, PLACE THE UNIT WELL AWAY (MORE THAN 2M.) FROM HEAT SOURCES SUCH AS RADIATORS, HEAT REGISTORS, FURNACE, STOVES, ETC.
- WHEN MOVING THE AIR-CONDITIONER FOR INSTALLING IT IN ANOTHER PLACE AGAIN, BE VERY CAREFUL NOT TO GET THE SPECIFIED REFRIGERANT (R-22) WITH ANY OTHER GASEOUS BODY INTO THE REFRIGERATION CYCLE. IF AIR OR ANY OTHER GAS IS MIXED IN THE REFRIGERANT, THE GAS PRESSURE IN THE REFRIGERATION CYCLE BECOMES ABNORMALLY HIGH AND IT RESULTINGLY CAUSES BURST OF THE PIPE AND INJURIES ON PERSONS.
- IN THE EVENT THAT THE REFRIGERANT GAS LEAKS OUT OF THE PIPE DURING THE INSTALLATION WORK, IMMEDIATELY LET FRESH AIR INTO THE ROOM. IF THE REFRIGERANT GAS IS HEATED BY FIRE OR SOMETHING ELSE, IT CAUSES GENERATION OF POISONOUS GAS.

WARNING

- Never modify this unit by removing any of the safety guards or by by-passing any of the safety interlock switches.
- Do not install in a place which cannot bear the weight of the unit. Personal injury and property damage can result if the unit falls.
- Before doing the electrical work, attach an approved plug to the power supply cord. And make sure the equipment to be earthed.
- Appliance shall be installed in accordance with national wiring regulations. If you detect any damage, do not install the unit. Contact your Toshiba dealer immediately.

CAUTION

- Exposure of unit to water or other moisture before installation will result in an electrical short. Do not store in a wet basement or expose to rain or water.
- After unpacking the unit, examine it carefully for possible damage.
- Do not install in a place that can increase the vibration of the unit. Do not install in a place that can amplify the noise level of the unit or where noise and discharged air might disturb user's neighbors.
- To avoid personal injury, be careful when handling parts with sharp edges.
- Please read the installation manual carefully before installing the unit. It contains further important instructions for proper installation.

For general public use

Power supply cord of parts of appliance for outdoor use shall be more than polychloroprene sheathed flexible cord (design H07 RN-F), or cord designation 245 IEC 66. (2,0mm² or more)

Remark per EMC Directive 89/336/EEC

For to prevent flicker impressions during the start of the compressor (technical process) following installation conditions do apply.

- The power connection for the air conditioner has to be done at the main power distribution. This distribution has to be of an impedance. Normally the required impedance is reached at a 32A fusing point. Air conditioner fuse has to be 16A max.!
- No other equipment has to be connected to this power line.
- For detailed installation acceptance please refer to your contact with the power supplier, it restriction do apply for products like washing machines, air conditioners or electrical ovens.
- For power details of the air conditioner refer to the rating plate of the product.

9-1-1. Installation Diagram of Indoor and Outdoor Units

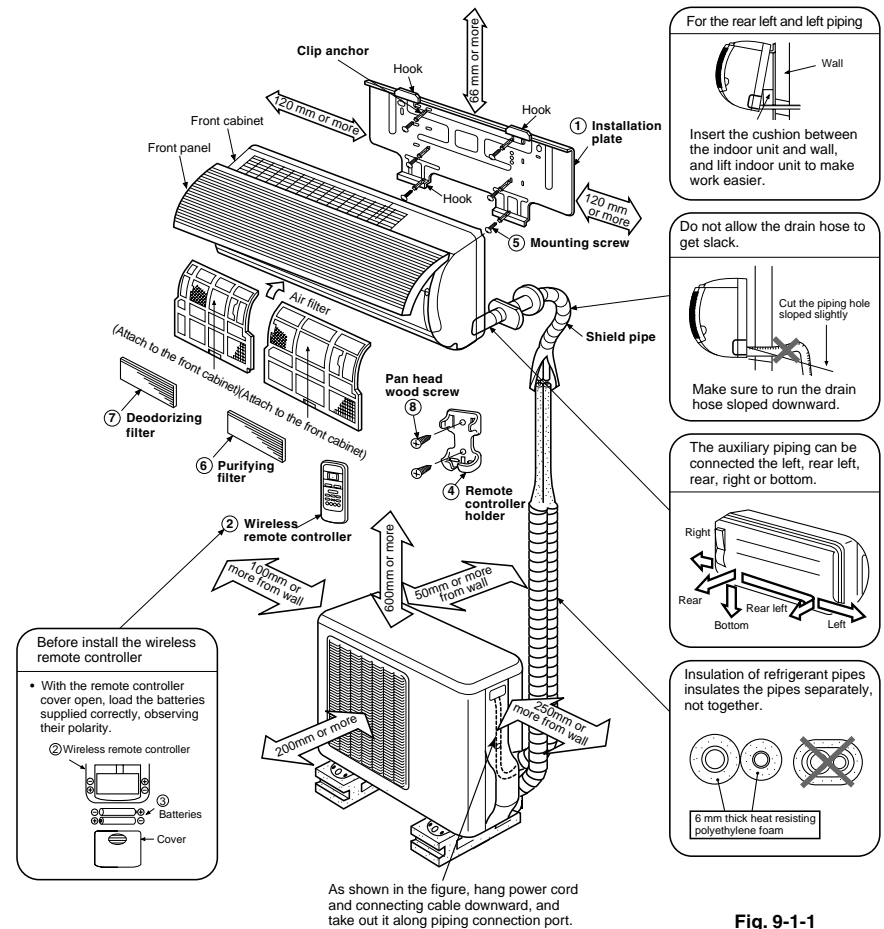

Fig. 9-1-1

9-1-2. Optional Installation Parts

Part code	Parts name	Q'ty
(A)	Refrigerant piping Liquid side : Ø6,35 Gas side : Ø9,52	Each one
(B)	Pipe insulating material (Polyethylene foam, 6mm thick)	1
(C)	Putty, PVC tapes	Each one

Fixing bolt arrangement of outdoor unit

- Secure the outdoor unit with the fixing bolts and nuts if the unit is likely to be exposed to a strong wind.
- Use ø8 mm or ø10 mm anchor bolts and nuts.
- If it is necessary to drain the defrost water attach drain nipple to the bottom plate of the outdoor unit before installing it.

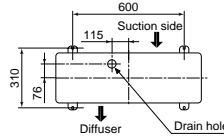

Fig. 9-1-2

9-1-3. Accessory and Installation Parts

Part No.	Part name (Q'ty)	Part No.	Part name (Q'ty)	Name
①	Installation plate x 1	⑤	Mounting screw Ø4 x 25 l x 6	Others Owner's manual Installation manual
②	Wireless remote controller x 1	⑥	Purifying filter x 1	
③	Battery x 2	⑦	Deodorizing filter x 1	This model is not equipped with an extension drain hose. Option : For the extension drain hose, use an optionally available RB-821SW or commercially available one.
④	Remote controller holder x 1	⑧	Pan head wood screw Ø3,1x 16 l x 2	

9-1-4. Installation/Service Tools Changes in the product and components

In the case of an air conditioner using R410A, in order to prevent any other refrigerant from being charged accidentally, to service port diameter of the outdoor unit control valve (3 way valve) has been changed. (1/2 UNF 20 threads per inch)

- In order to increase the pressure resisting strength of the refrigerant piping flare processing diameter and size of opposite side of flare nuts has been changed. (for copper pipes with nominal dimensions 1/2 and 5/8)

New tools for R410A

New tools for R410A	Applicable to R22 model	Changes
Gauge manifold	✗	As pressure is high, it is impossible to measure by means of conventional gauge. In order to prevent any other refrigerant from being charged, each port diameter has been changed.
Charge hose	✗	In order to increase pressure resisting strength, hose materials and port size have been changed (to 1/2 UNF 20 threads per inch). When purchasing a charge hose, be sure to confirm the port size.
Electronic balance for refrigerant charging	○	As pressure is high and gasification speed is fast, it is difficult to read the indicated value by means of charging cylinder, as air bubbles occur.
Torque wrench (nominal diam. 1/2, 5/8)	✗	The size of opposite sides of flare nuts have been increased. Incidentally, a common wrench is used for nominal diameters 1/4 and 3/8.
Flare tool (clutch type)	○	By increasing the clamp bar's receiving hole, strength of spring in the tool has been improved.
Gauge for projection adjustment	—	Used when flare is made by using conventional flare tool.
Vacuum pump adapter	○	Connected to conventional vacuum pump. It is necessary to use an adapter to prevent vacuum pump oil from flowing back to the charge hose. The charge hose connecting part has two ports-one for conventional refrigerant (7/16 UNF 20 threads per inch) and one for R410A. If the vacuum pump oil (mineral) mixes with R410A a sludge may occur and damage the equipment.
Gas leakage detector	✗	Exclusive for HFC refrigerant. Exclusive for HFC refrigerant.

- Incidentally, the "refrigerant cylinder" comes with the refrigerant designation (R410A) and protector coating in the U. S's ARI specified rose color (ARI color code: PMS 507).
- Also, the "charge port and packing for refrigerant cylinder" require 1/2 UNF 20 threads per inch corresponding to the charge hose's port size.

9-2. Indoor Unit

9-2-1. Installation Place

- A place which provides the spaces around the indoor unit as shown in the above diagram.
- A place where there is no obstacle near the air inlet and outlet.
- A place which allows an easy installation of the piping to the outdoor unit.
- A place which allows the front panel to be opened.

CAUTION

- Direct sunlight to the indoor unit wireless receiver should be avoided.
- The microprocessor in the indoor unit should not be too close to r-f noise sources. (For details, see the owner's manual.)

Remote controller

- A place where there are no obstacles such as a curtain that may block the signal from the indoor unit.
- Do not install the remote controller in a place exposed to direct sunlight or close to a heating source, such as a stove.
- Keep the remote controller at least 1 m apart from the nearest TV set or stereo equipment. (This is necessary to prevent image disturbances or noise interference.)
- The location of the remote controller should be determined as shown below.

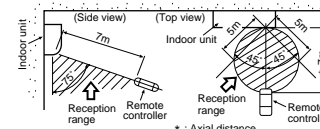

Fig. 9-2-1

9-2-2. Cutting a Hole and Mounting Installation Plate

Cutting a Hole

When install the refrigerant pipes from the rear.

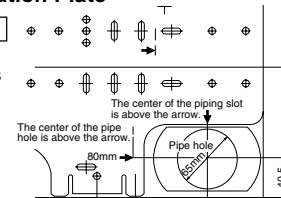

Fig. 9-2-2

- After determining the pipe hole position on the mounting plate (80 mm →), drill the pipe hole (ø65 mm) at a slight downward slant to the outdoor side.

NOTE

- When drilling the wall that contains a metal lath, wire lath or metal plate, be sure to use a pipe hole brim ring sold separately.

Mounting the Installation Plate

For installation of the indoor unit, use the paper pattern on the back.

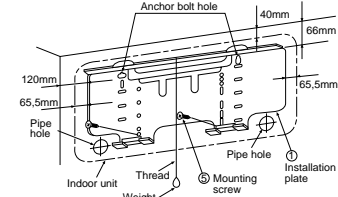

Fig. 9-2-3

When the installation plate is directly mounted on the wall

- Securely fit the installation plate onto the wall by screwing it in the upper and lower parts to hook up the indoor unit.
- To mount the installation plate on a concrete wall with anchor bolts, utilize the anchor bolt holes as illustrated in the above figure.
- Install the installation plate horizontally in the wall.

CAUTION

When installing the installation plate with mounting screw, do not use the anchor bolt hole. Otherwise the unit may fall down and result in personal injury and property damage.

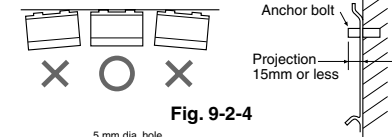

Fig. 9-2-4

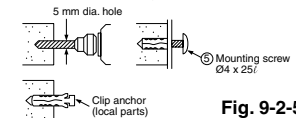

Fig. 9-2-5

CAUTION

Failure to firmly install the unit may result in personal injury and property damage if the unit falls.

- In case of block, brick, concrete or similar type walls, make 5 mm dia. holes in the wall.
- Insert clip anchors for appropriate ⑤ mounting screws.

NOTE

- Install the installation plate using 4 to 6 pieces of mounting screw securing four corners with screws.

9-2-3. Electrical Work

1. The supply voltage must be the same as the rated voltage of the air conditioner.
2. Prepare the power source for exclusive use with the air conditioner.

NOTE

- Wire type : More than H07RN-F or 245IEC66 (2,0mm² or more)

CAUTION

- Use power specified above table.
- This appliance can be connected to the mains in either of the following two ways.
 - (1) Connection to fixed wiring :
A switch or circuit breaker which disconnects all poles and has a contact separation of at least 3 mm must be incorporate in the fixed wiring. An approved circuit breaker or switches must be used.
 - (2) Connection with power supply plug :
Attach power supply plug with power cord and plug it into wall outlet. An approved power supply cord and plug must be used.

NOTE

- Perform wiring works so as to allow a generous wiring capacity.

9-2-4. Wiring Connection

How to remove the front cabinet

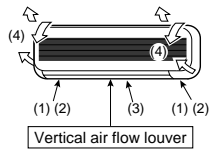

Fig. 9-2-6

How to open the screw cap

- Place your finger on the lower part and push to open the screw cap.



Fig. 9-2-7

1. Open the screw caps and remove the two screws securing the front cabinet.
2. Close the screw caps as behind.
3. Open the vertical air flow louvers horizontally by hand.
4. Slightly open the lower part of the front cabinet then pull the upper part of the front cabinet toward you to remove it from the rear plate.

How to connect the connecting cable

Wiring of the connecting cable can be carried out without removing of the front cabinet.

1. Remove the front cabinet.
Fully open the front cabinet. Disengage the support arm located in the upper center while pushing its handle leftwards, and then remove the panel toward you.
2. Remove the terminal cover and cord clamp.
3. Insert the connecting cable (according to local cords) into pipe hole on the wall.
4. Take out the connecting cable through the cable slot on the rear panel so that it is exploded by about 15 cm long in the front side.
5. Insert the connecting cable fully into the terminal block and secure it by screw tightly.
6. Tightening torque : 1,2 N•m (0,12 kgf•cm)
7. Secure the connecting cable with the cord clamp.
8. Fix the wiring cover, rear plate bushing and front cabinet on the indoor unit.

CAUTION

- Be sure to refer to the wiring system diagram labeled inside the front panel.
- Check local electrical cords and also any specific wiring instructions or limitation.

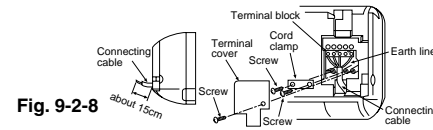
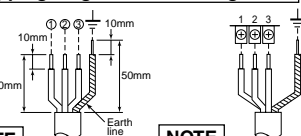

Fig. 9-2-8

Stripping length of connecting cable



NOTE

Use stranded wire only.
WIRE TYPE : more than H05 RN-F

NOTE

Connect the earth line to the metallic part (⊥ mark) located at the side of 3P terminal.

Fig. 9-2-9

How to install the front cabinet on the indoor unit

- Install the front cabinet through the opposite order of "How to remove the front cabinet". When the panel is removed and mounted again, take the following actions:
After fastening the two screws, one each at the left and right of the air outlet be sure to push the upper center ①, right end ②, left end ③ and the lower center ④ of the air outlet, and confirm that no gap is left between the front cabinet and the rear plate.
- If cooling (dry) operation is made without pushing the air outlet, dew can be deposited on the front cabinet surface. In addition a gap between the front cabinet and the rear plate will become wider, spoiling the appearance.

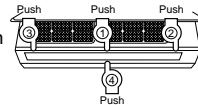

Fig. 9-2-10

9-2-5. Piping and Drain Hose Installation

In case of rightward piping

- After scribing slits of the front cabinet and the rear panel by a knife or a marking-off pin, cut them by a pair of nippers or the like.

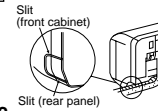

Fig. 9-2-12

In case of downward piping

- After scribing the slit of the front cabinet and slit in the lower part of the rear panel by a knife or a marking-off pin, cut them by a pair of nippers or the like.

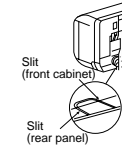

Fig. 9-2-13

Left-hand connection with piping

Bend the connecting pipe so that it is laid within 43 mm above the wall surface. If the connecting pipe is laid exceeding 43 mm above the wall surface, the indoor unit may unstably be set on the wall. When bending the connecting pipe, make sure to use spring bender so as not to crush the pipe. **Bend the connection pipe within a radius of 30 mm.** To connect pipe after installation of unit (figure)

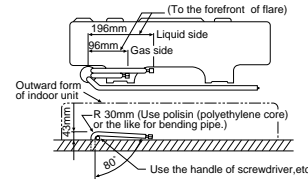

Fig. 9-2-14

NOTE

If the pipe is bent incorrectly, the indoor unit may unstably be set on the wall.
After passing the connecting pipe through the hole, connect the connecting pipe to the auxiliary pipes and wrap the facing tape around them.

CAUTION

- Bind the auxiliary pipes (two) and connecting cable with facing tape tightly. In case of leftward piping and rear-leftward piping, bind the auxiliary pipes (two) only with facing tape.
- Carefully arrange pipes so that any pipe does not stick out of the rear plate of the indoor unit.
- Carefully connect the auxiliary pipes and connecting pipes to each other and cut off the insulating tape wound on the connecting pipe to avoid double-taping at the joint, moreover, seal the joint with the vinyl tape, etc.
- Since dewing results in a machine trouble, make sure to insulate both the connecting pipes. (Use polyethylene foam as insulating material.)
- When bending a pipe, carefully do it not to crush it.

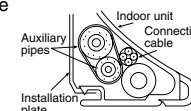

Fig. 9-2-15

9-2-6. Indoor Unit Fixing

1. Pass the pipe through the hole in the wall, and hook the indoor unit on the installation plate at the upper hooks.
2. Swing the indoor unit to right and left to confirm that it is firmly hooked up on the installation plate.
3. While pressing the indoor unit onto the wall, hook it at the lower part on the installation plate. Pull the indoor unit toward you to confirm that it is firmly hooked up on the installation plate.

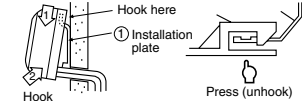

Fig. 9-2-16

- For detaching the indoor unit from the installation plate pull the indoor unit toward you while pushing its bottom up at the specified parts.

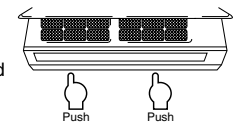

Fig. 9-2-17

9-2-7. Drainage

1. Run the drain hose sloping downwards.

NOTE

- Hole should be made at a slight downward slant on the outdoor side.

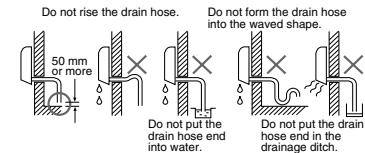

Fig. 9-2-18

2. Put water in the drain pan and make sure that the water is drained out of doors.
3. When connecting extension drain hose, insulate the connecting part of extension drain hose with shield pipe.

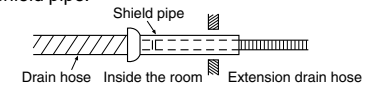

Fig. 9-2-19

CAUTION

Arrange the drain pipe for proper drainage from the unit.
Improper drainage can result in dew-dropping.

This air conditioner has the structure designed to drain water collected from dew, which forms on the back of the indoor unit, to the drain pan. Therefore, do not store the power cord and other parts at a height above the drain guide.

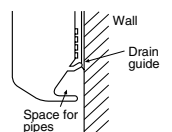

Fig. 9-2-20

9-3. Outdoor Unit

9-3-1. Installation Place

- A place which provides the spaces around the outdoor unit as shown in the left diagram.
- A place which can bear the weight of the outdoor unit and does not allow an increase in noise level and vibration.
- A place where the operation noise and discharged air do not disturb your neighbors.
- A place which is not exposed to a strong wind.
- A place free of a leakage of combustible gases.
- A place which does not block a passage.
- When the outdoor unit is to be installed in an elevated position, be sure to secure its feet.
- An allowable length of the connecting pipe is up 15m.
- An allowable height level is up to 10 m.
- A place where the drain water does not raise any problem.

CAUTION

1. Install the outdoor unit without anything blocking the air discharging.
2. When the outdoor unit is installed in a place exposed always to a strong wind like a coast or on a high story of a building, secure the normal fan operation using a duct or a wind shield.
3. Specially in windy area, install the unit to prevent the admission of wind.
4. Installation in the following places may result trouble. Do not install the unit such places.
 - A place full of machine oil.
 - A saline-place such as coast.
 - A place full of sulfide gas.
 - A place where high-frequency waves are likely to be generated as from audio equipment, welders, and medical equipment.

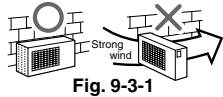

Fig. 9-3-1

9-3-2. Refrigerant Piping Connection

Flaring 1. Cut the pipe with a pipe cutter.

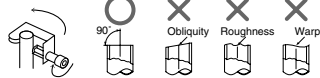

Fig. 9-3-2

2. Insert a flare nut into the pipe, and flare the pipe.
 - **Projection margin in flaring : A (Unit : mm)**
 - Rigid (Clutch type)

Outer dia. of copper pipe	R410A tool used	Conventional tool used
6,35	0 to 0,5	1,0 to 1,5
9,52	0 to 0,5	1,0 to 1,5
12,7	0 to 0,5	1,0 to 1,5

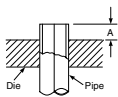

Fig. 9-3-3

Imperial (Wing nut type)

Outer dia. of copper pipe	R410A
6,35	1,5 to 2,0
9,52	1,5 to 2,0
12,7	2,0 to 2,5

Tightening Connection

Align the centers of the connecting pipes and tighten the flare nut as far as possible with your fingers. Then tighten the nut with a spanner and torque wrench as shown in the figure.

CAUTION

- Do not apply excess torque. Otherwise, the nut may crack depending on the conditions.

(Unit : N·m)

Outer dia. of copper pipe	Tightening torque
ø6,35 mm	14 to 18 (1,4 to 1,8 kgf·m)
ø9,52 mm	33 to 42 (3,3 to 4,2 kgf·m)
ø12,7 mm	50 to 62 (5,0 to 6,2 kgf·m)

- **Tightening torque of flare pipe connections**

Pressure of R410A becomes higher than that of R22. (Approx. 1.6 times) Therefore, using a torque wrench, tighten firmly the flare pipe connecting sections which connect the indoor and outdoor units up to the specified tightening torque. Incorrect connections may cause not only a gas leakage, but also a trouble of the refrigeration cycle.

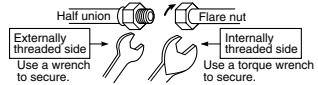

Fig. 9-3-5

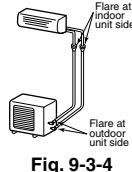

Fig. 9-3-4

9-3-3. Evacuating

After the piping has been connected to all indoor unit(s), you can perform the air purge together at once.

AIR PURGE

Evacuate the air in the connecting pipes and in the indoor unit using vacuum pump. Do not use the refrigerant in the outdoor unit. For details, see the manual of vacuum pump.

Use a vacuum pump

Be sure to use a vacuum pump with counter-flow prevention function so that inside oil of the pump does not flow backward into pipes of the air conditioner when the pump stops. (If inside oil of the vacuum pump enters into the air conditioner which adopts R410A, a trouble of the refrigeration cycle may be caused.)

1. Connect the charge hose from the manifold valve to the service port of the gas side packed valve.
2. Connect the charge hose to the port of vacuum pump.
3. Open fully the low pressure side handle of the gauge manifold valve.
4. Operate the vacuum pump to start for evacuating. Perform evacuating for about 15 minutes if the piping length is 20 meters. (15 minutes for 20 meters) (assuming a pump capacity of 27 liters per minute.) Then confirm that the compound pressure gauge reading is -101 kPa (-76 cmHg).
5. Close the low pressure side valve handle of gauge manifold.
6. Open fully the valve stem of the packed valves (both side of Gas and Liquid).
7. Remove the charging hose from the service port.
8. Securely tighten the caps on the packed valves.

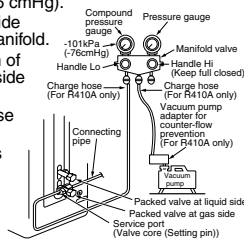

Fig. 9-3-6

CAUTION

- **KEEP IMPORTANT 4 POINTS FOR PIPING WORK**

1. Take away dust and moisture (Inside of the connecting pipes.)
2. Tight connection (between pipes and unit)
3. EVACUATE the air in the connecting pipes using VACUUM PUMP.
4. Check gas leak (connected points)

Packed Valve Handling Precautions

- Open the valve stem all the way out; but do not try to open it beyond the stopper.
- Securely tighten the valve stem cap with torque in the following table :

Gas side (ø12,7 mm)	50 to 62 N·m (5,0 to 6,2 kgf·m)
Gas side (ø9,52 mm)	33 to 42 N·m (3,3 to 4,2 kgf·m)
Liquid side (ø6,35 mm)	14 to 18 N·m (1,4 to 1,8 kgf·m)
Service port	14 to 18 N·m (1,4 to 1,8 kgf·m)

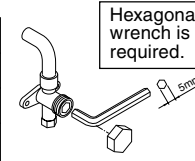

Fig. 9-3-7

9-3-4. Wiring Connection

1. Remove the electric parts cover from the outdoor unit.
2. Connect the connecting cable to the terminal as identified with their respective matched numbers on the terminal block of indoor and outdoor unit.
3. When connecting the connecting cable to the outdoor unit terminal, make a loop as shown installation diagram of indoor and outdoor unit, to prevent water coming in the outdoor unit.
4. Insulate the unused cords (conductors) with water coming in the outdoor unit. Process them so that they do not touch any electrical or metal parts.

Stripping length of connecting cable

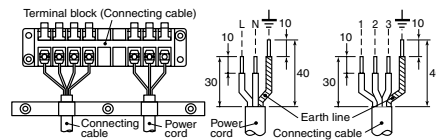

Fig. 9-3-8

Model	RAS-10YKV-E/RAS-13YKV-E
Power source	50/60 Hz, 220 - 240 V Single phase
Maximum running current	8,5A
Plug socket & fuse rating	10A
Power cord	H07RN-F or 245IEC66 (2,0mm ² or more)

CAUTION

- Wrong wiring connection may cause some electrical parts burn out.
- Be sure to comply with local codes on running the wire from outdoor unit to indoor unit (size of wire and wiring method etc.)
- Every wire must be connected firmly.

NOTE : Connecting cable

- Wire type : More than H07RN-F or 245IEC66 (2,0mm² or more)

9-3-5. Gas Leak Test

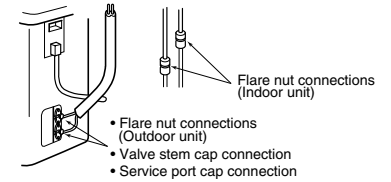

Fig. 9-3-9

- Check the flare nut connections, valve stem cap connections and service port cap connections for gas leak with a leak detector or soap water.

9-3-6. Test Operation

To switch the TEST RUN (COOL) mode, press TEMPORARY button for 10 sec. (The beeper will make a short beep.)

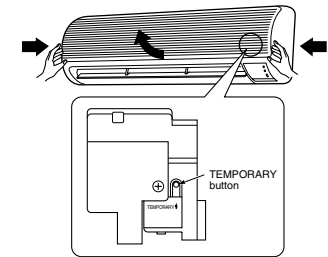

Fig. 9-3-10

9-3-7. Auto Restart Setting

This product is designed so that, after a power failure, it can restart automatically in the same operating mode as before the power failure,

Information

The product was shipped with Auto Restart function in the off position. Turn it on as required.

How to Set the Auto Restart

- Press and hold down the TEMPORARY button for about 3 seconds. After 3 seconds, the electronic beeper makes three short beeps to tell you the Auto Restart has been selected.
- To cancel the Auto Restart, follow the steps described in the section Auto Restart Function of the Owner's Manual.

10. HOW TO DIAGNOSE THE TROUBLE

The pulse modulating circuits are mounted to both indoor and outdoor units. Therefore, diagnose troubles according to the trouble diagnosis procedure as described below. (Refer to the check points in servicing written on the wiring diagrams attached to the indoor/outdoor units.)

Table 10-1

No.	Troubleshooting Procedure	Page
1	First Confirmation	40
2	Primary Judgment	41
3	Judgment by Flashing LED of Indoor Unit	42
4	Self-Diagnosis by Service Check Remote Controller	43
5	Judgment of Trouble by Every Symptom	46
6	How to Check Simply the Main Parts	53

NOTE :

A large-capacity electrolytic capacitor is used in the outdoor unit controller (inverter). Therefore, if the power supply is turned off, charge (charging voltage DC280V) remains and discharging takes a lot of time. After turning off the power source, if touching the charging section before discharging, an electrical shock may be caused. Discharge the electrolytic capacitor completely by using soldering iron, etc.

< Discharging method >

- (1) Remove the inverter cover (plating) by opening four mounting claws.
- (2) As shown below, connect the discharge resistance (approx. 100Ω40W) or plug of the soldering iron to voltage between + – terminals of the C14 (“CAUTION HIGH VOLTAGE 320V” is indicated.) electrolytic capacitor (500μF/400V) on P.C. board, and then perform discharging.

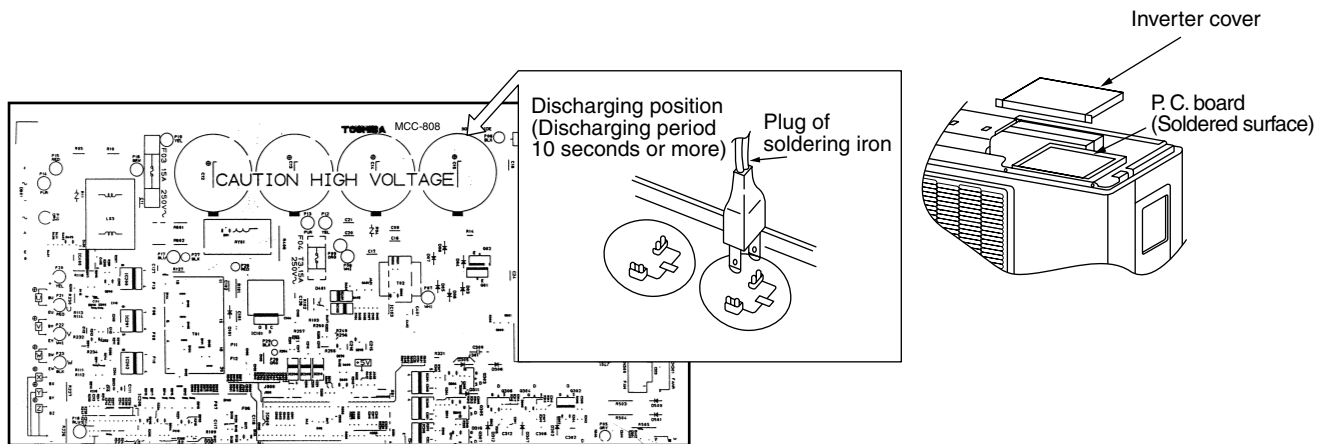

Fig. 10-1

10-1. First Confirmation

10-1-1. Confirmation of Power Supply

Confirm that the power breaker operates (ON) normally.

10-1-2. Confirmation of Power Voltage

Confirm that power voltage is AC 220–230–240 ± 10%. If power voltage is not in this range, the unit may not operate normally.

10-1-3. Operation Which is not a Trouble (Program Operation)

For controlling the air conditioner, the program operations are built in the microcomputer as described in the following table. If a claim is made for running operation, check whether or not it meets to the contents in the following table. When it does, we inform you that it is not trouble of equipment, but it is indispensable for controlling and maintaining of air conditioner.

Table 10-1-1

No.	Operation of air conditioner	Description
1	When power breaker is turned "ON", the operation lamp (Green) of the indoor unit flashes.	The OPERATION lamp of the indoor unit flashes when power source is turned on. If [START/STOP] button is operated once, flashing stops. (Flashes also in power failure)
2	Compressor may not operate even if the room temperature is within range of compressor-ON.	The compressor does not operate while compressor restart delay timer (3-minutes timer) operates. The same phenomenon is found after power source has been turned on because 3-minutes timer operates.
3	In Dry and ECONO. mode, FAN (air flow) display does not change even though FAN (air flow select) button is operated.	The air flow indication is fixed to [AUTO].
4	Increasing of compressor motor speed stops approx. 30 seconds after operation started, and then compressor motor speed increases again approx. 30 seconds after.	For smooth operation of the compressor, the compressor motor speed is restricted to Max. 41 rps for 2 minutes, and Max.91 rps for 2 minutes to 3 minutes, respectively after the operation has started.
5	The set value of the remote controller should be below the room temperature.	If the set value is above the room temperature, Cooling operation is not performed. And check whether battery of the remote controller is consumed or not.
6	In AUTO mode, the operation mode is changed.	After selecting Cool or Heat mode, select an operation mode again if the compressor keeps stop status for 15 minutes.
7	In HEAT mode, the compressor motor speed does not increase up to the maximum speed or decreases before the temperature arrives at the set temperature.	The compressor motor speed may decrease by high-temp. release control (Release protective operation by temp.-up of the indoor heat exchanger) or current release control.

10-2. Primary Judgment

To diagnose the troubles, use the following methods.

- (1) Judgment by flashing LED of indoor unit
- (2) Self-diagnosis by service check remote controller
- (3) Judgment of trouble by every symptom

Firstly use the method (1) for diagnosis. Then, use the method (2) or (3) to diagnose the details of troubles.

10-3. Judgment by Flashing LED of Indoor Unit

While the indoor unit monitors the operation status of the air conditioner, if the protective circuit operates, the contents of self-diagnosis are displayed with block on the indoor unit indication section.

Table 10-3-1

	Item	Check code	Block display		Description for self-diagnosis
<div style="border: 1px solid black; padding: 5px; width: fit-content;">Indoor indication lamp flashes.</div> <div style="margin-top: 10px; border: 1px solid black; padding: 5px; width: fit-content;">Which lamp does flash?</div> <div style="margin-top: 10px;"> </div>	A	—	OPERATION ↳ECONO. TIMER PRE DEF.	 OPERATION (Green) Flashing display (1 Hz)	Power failure (when power is ON)
	B	00	OPERATION ↳ECONO. TIMER PRE DEF.	 OPERATION (Green) Flashing display (5 Hz)	Protective circuit operation for indoor P.C. board
	C	01	OPERATION ↳ECONO. TIMER PRE DEF.	 OPERATION (Green) TIMER (Yellow) Flashing display (5 Hz)	Protective circuit operation for connecting cable and serial signal system
	D	02	OPERATION ↳ECONO. TIMER PRE DEF.	 OPERATION (Green) PRE DEF. (Orange) Flashing display (5 Hz)	Protective circuit operation for outdoor P.C. board
	E	03	OPERATION ↳ECONO. TIMER PRE DEF.	 OPERATION (Green) TIMER (Yellow) PRE DEF. (Orange) Flashing display (5 Hz)	Protective circuit operation for others (including compressor)

NOTES :

- (1) The contents of items B and C and a part of item E are displayed when air conditioner operates.
- (2) When item B and C, and item B and a part of item E occur concurrently, priority is given to the block of item B.
- (3) The check codes can be confirmed on the remote controller for servicing.

10-4. Self-Diagnosis by Remote Controller (Check Code)

- (1) The self-diagnosis by the check code is performed while items B to E blocks are displayed.
- (2) When turning the operation mode on the remote controller to the service mode, and operating the remote controller, the controller of the indoor unit can self-diagnose operation of the protection circuit by displayed contents (check code) on the remote controller, by whether all the lamps flash (5Hz) and the receiving sound (Pi, Pi, Pi ... for 10 seconds) is heard. The timer lamp usually flashes (5Hz) during self-diagnosis.

10-4-1. Self-Diagnosis

1 Push the CHK button by something with thin edge.

- Check **00** is displayed in the indication part of the remote controller.

2 Push toward the remote controller one by one. If it is normal, the receiving sound “Pi” is heard every pushing it and check code in the indication part of the remote controller changes.

3 To release the self-diagnosis function, push .

Alphanumeric characters are used for the check codes.

5 is 5.	6 is 6.
A is A.	B is B.
C is C.	D is D.

Fig. 10-4-1

10-4-2. Operation Control by Rated Frequency in Service Mode

In the service mode, pushing “ON” or “OFF” operates the air conditioner by rated frequency of COOL or HEAT mode for 30 minutes. (Cooling function operates under condition of room temperature by 24°C or more while heating function by 23°C or less, respectively.)

10-4-3. Caution at Servicing

- (1) After servicing, push the START/STOP button to return to the normal mode.
- (2) After servicing by the check code, turn off breaker of the power supply, and turn on breaker of the power supply again so that memory in the microcomputer returns the initial status. However, the check codes are not deleted even if the power supply is turned off because they are stored in the fixed memory.

Table 10-4-1

Block distinction		Operation of diagnosis function				Judgment and action
Check code	Block	Check code	Cause of operation	Air conditioner status	Remarks	
00	Indoor P.C. board etc.	01	Short-circuit or disconnection of the room temperature sensor (TA sensor).	Operation continues.	Displayed when error is detected.	1. Check the room temp. sensor. 2. When the room temp. sensor is normal, check P.C. board.
		02	Being out of place, disconnection, short-circuit, or migration of heat exchanger sensor (TC sensor)	Operation continues.	Displayed when error is detected.	1. Check heat exchanger sensor. 2. When heat exchanger sensor is normal, check P.C. board.
		11	Lock of indoor fan or trouble on the indoor fan circuit	All off	Displayed when error is detected.	1. Check P.C. board. 2. When P.C. board is normal, check the motor.
	Not displayed	12	Trouble on other indoor P.C. boards	Operation continues.	Displayed when error is detected.	Replace P.C. board.
01	Connecting cable and serial signal	04	Return serial signal is not sent to indoor side from operation started. (1) Defective wiring of connecting cable (2) Operation of compressor thermo. Gas shortage Gas leak	Operation continues.	Flashes when trouble is detected on Return serial signal, and normal status when signal is reset.	1. When the outdoor unit never operate: (1) Check connecting cable, and correct if defective wiring. (2) Check 25A fuse of inverter P.C. board. (3) Check 3,15A of inverter P.C. board. 2. To display [Other] block during operation, check compressor thermo. operation and supply gas (check gas leak also). 3. Unit operates normally during check. If Return serial signal does not stop between indoor terminal board 2 and 3, replace inverter P.C. board. If signal stops between indoor terminal board 2 and 3, replace indoor P.C. board.
		05	Operation command signal is not sent to outdoor side.	Operation continues	Flashes when trouble is detected on Operation command signal, and normal status when signal is reset.	If Return serial signal does not stop between indoor terminal board 2 and 3, replace inverter P.C. board. If signal stops between indoor terminal board 2 and 3, replace indoor P.C. board.

Block distinction		Operation of diagnosis function				Judgment and action
Check code	Block	Check code	Cause of operation	Air conditioner status	Remarks	
02	Outdoor P.C. board	14	Inverter over-current protective circuit operates. (Short time)	All off	Displayed when error is detected.	Even if trying operation again, all operations stop immediately. : Replace P.C. board.
		16	Position-detect circuit error or short-circuit between windings of compressor	All off	Displayed when error is detected.	1. Even if connecting lead wire of compressor is removed, position-detect circuit error occurred. : Replace P.C. board. 2. Measure resistance between wires of compressor, and perform short-circuit. : Replace compressor.
		17	Current-detect circuit error	All off	Displayed when error is detected.	Even if trying operation again, all operations stop immediately. : Replace P.C. board.
		18	Being out of place, disconnection or short-circuit of outdoor temp. sensor	All off	Displayed when error is detected.	1. Check outdoor temp. sensors (TE, TS). 2. Check P.C. board.
		19	Disconnection or short-circuit of discharge temp. sensor	All off	Displayed when error is detected.	1. Check discharge temp. sensor (TD). 2. Check P.C. board
		1A	Outdoor fan drive system error	All off	Displayed when error is detected.	Position-detect error, over-current protective operation of outdoor fan drive system, fan lock, etc. : Replace P.C. board or fan motor.
	Not displayed	1b	Outdoor heat exchanger temp. sensor error	Operation continues	—	1. Check outdoor heat exchanger temp. sensor (TE). 2. Check P.C. board.
	Outdoor P.C. board	1c	Compressor drive output error, Compressor error (lock, missing, etc.), Break down	All off	Displayed when error is detected.	When 20 seconds passed after start-up, position-detect circuit error occurred. : Replace compressor.
03	Others (including compressor)	07	Return serial signal has been sent when operation started, but it is not sent from halfway. (1) Compressor thermo. operation Gas shortage Gas leak (2) Instantaneous power failure	Operation continues	Flashes when trouble is detected on Return serial signal, and normal status when signal is reset.	1. Repeat Start and Stop with interval of approx. 10 to 40 minutes. (Code is not displayed during operation.) Supply gas. (Check also gas leak). 2. Unit operates normally during check. If Return serial signal does not stop between indoor terminal block 2 and 3, replace inverter P.C. board. If signal stops between indoor terminal block 2 and 3, replace indoor P.C. board.
		1d	Compressor does not rotate. (Current protective circuit does not operate when a specified time passed after compressor had been activated.)	All off	Displayed when error is detected.	1. Trouble on compressor 2. Trouble on wiring of compressor (Missed phase)
		1E	Discharge temp. exceeded 117°C	All off	Displayed when error is detected.	1. Check discharge temp. sensor (TD). 2. Degassing 3. Trouble on P.M.V.
		1F	Break down of compressor	All off	Displayed when error is detected.	1. Check power voltage. (220–30–40 V+10%) 2. Overload operation of refrigeration cycle Check installation condition (Short-circuit of outdoor diffuser).
		08	Four-way valve inverse error (TC sensor value lowered during heating operation.)	Operation continues	—	1. Check four-valve operation.

10-5. Judgment of Trouble by Every Symptom

10-5-1. Indoor Unit (Including Remote Controller)

(1) Power is not turned on (Does not operate entirely)

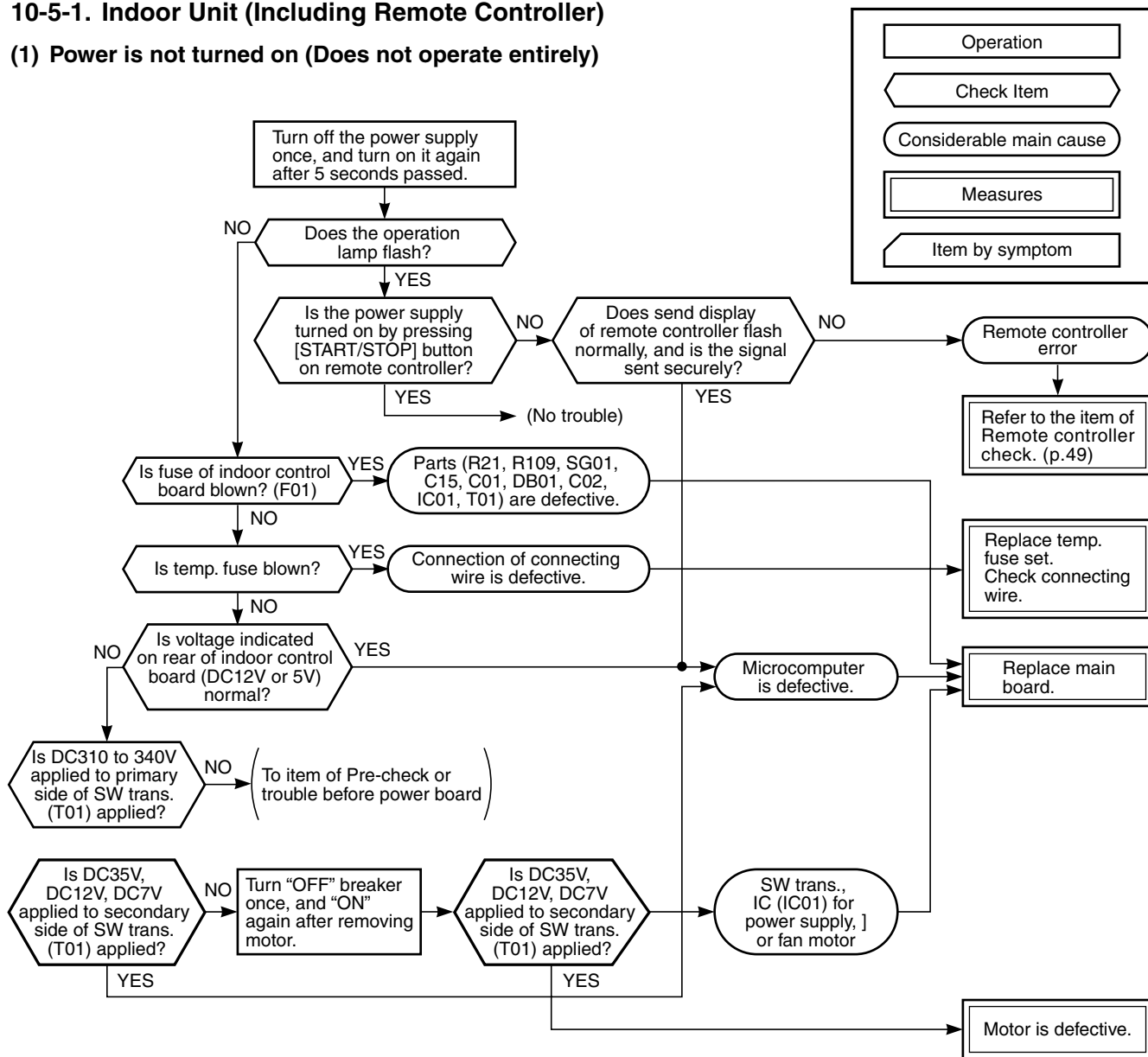

- Be sure to disconnect the motor connector CN10 after shut off the power supply, or it will be a cause of damage of the motor.

(2) Power is not turned on though Indoor P.C. board is replaced

<Confirmation procedure>

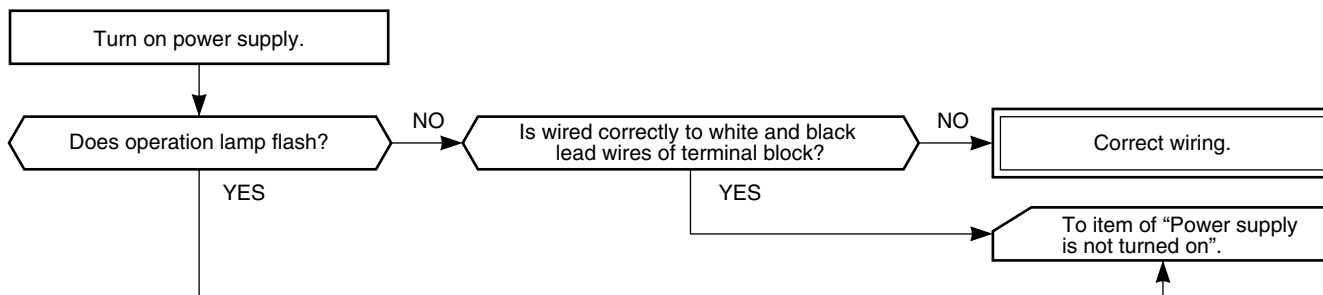

(3) Only the indoor fan does not operate

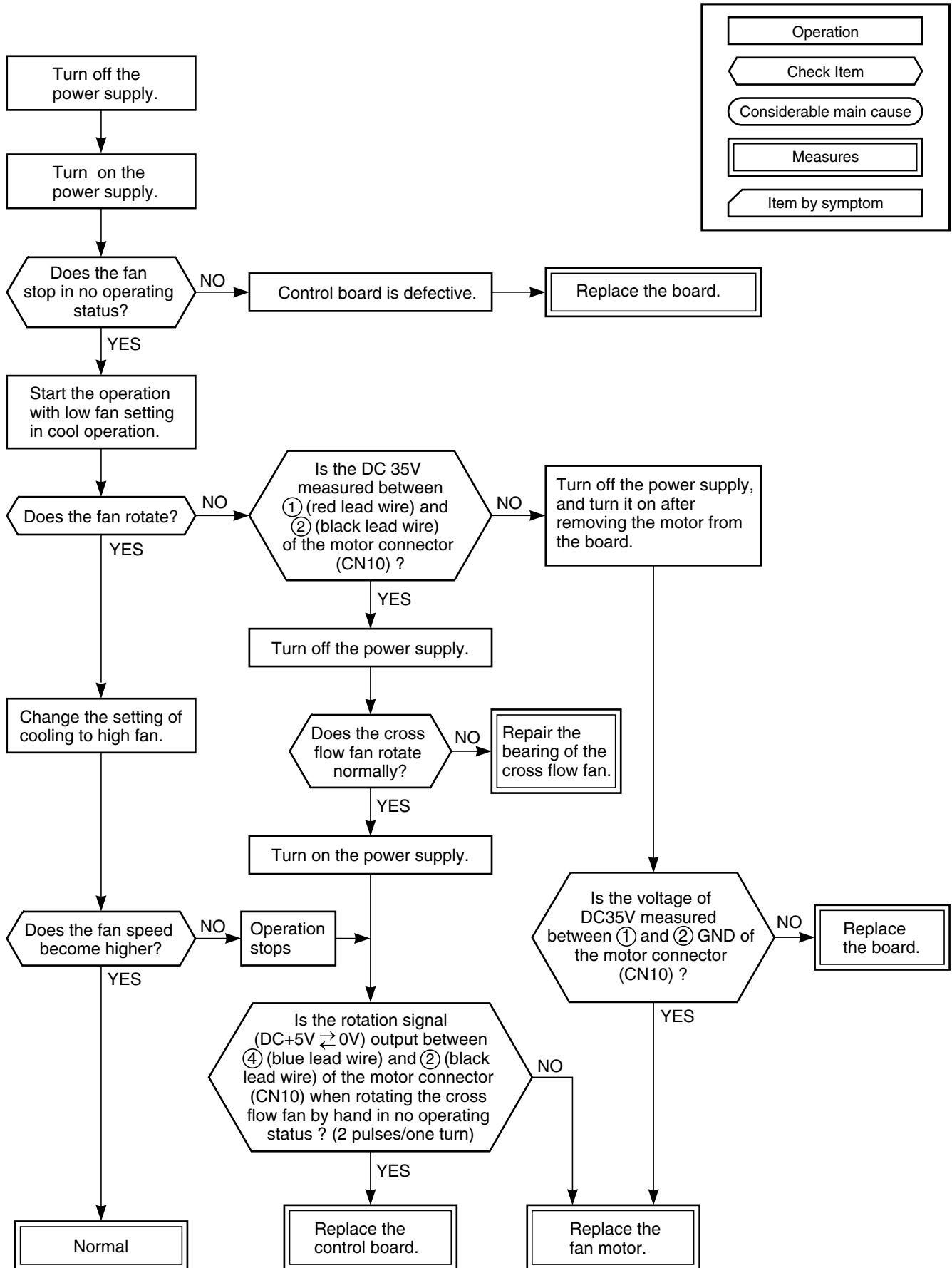

Operation
Check Item
Considerable main cause
Measures
Item by symptom

**(4) Indoor fan motor starts rotating by turning on power supply alone
(Operation may be normally performed (selected) by operation on the remote controller.)**

<Cause>

IC is built in the indoor fan motor, therefore P.C. board is also mounted to inside of the motor.

If soldering of P.C. board in the motor is defective or IC is defective, the fan motor may rotate by only inputting the power (turning on power supply).

<Confirmation procedure>

- (1) Remove the front panel.(Remove 2 screws and clicks.)
- (2) Remove cover of the fan motor lead wire. (1 click)
- (3) Check the voltage (DC) using CN10 connector while the fan rotates.

NOTE :

- Do not disconnect the connector while the fan rotates.
- Use a thin tester rod.

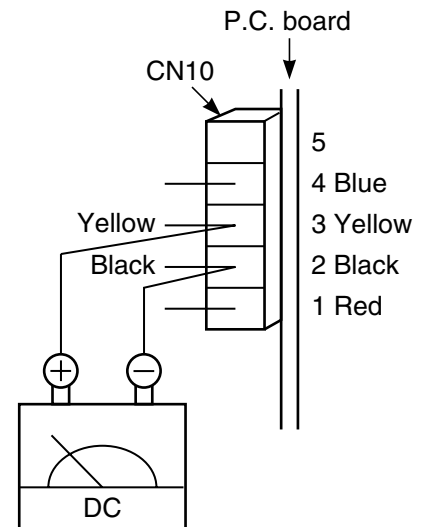
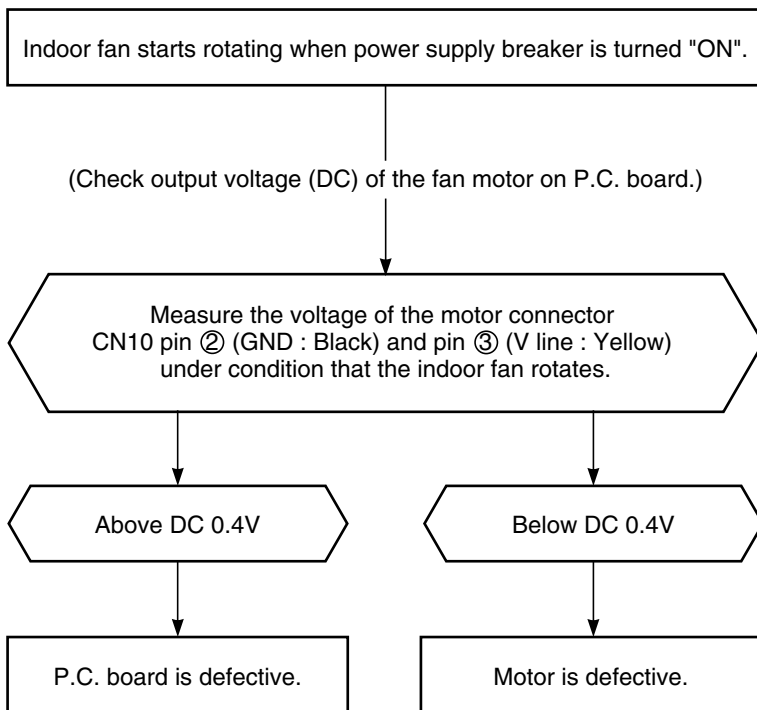

(5) How to examine whether remote controller is good or bad

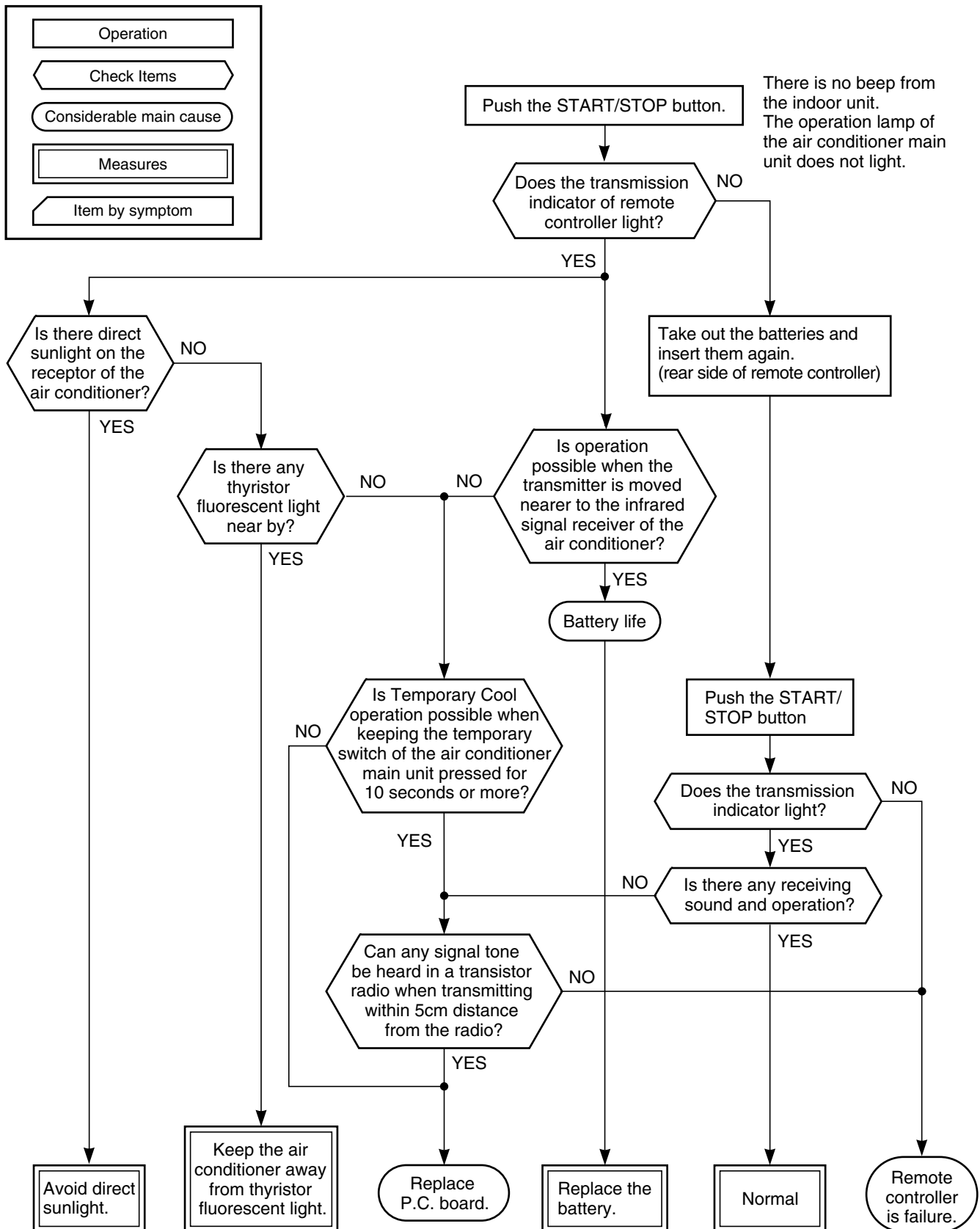

10-5-2. Wiring Failure (Interconnecting and Serial Signal Wire)

(1) Outdoor unit does not operate

- 1) Is the voltage between ② and ③ of the indoor terminal block varied?

Confirm that transmission from indoor to outdoor is correctly performed based upon the following diagram.

NOTE:

- Measurement should be performed 2 minutes and 30 seconds after starting of the operation.
- Be sure to prepare a diode for judgment.

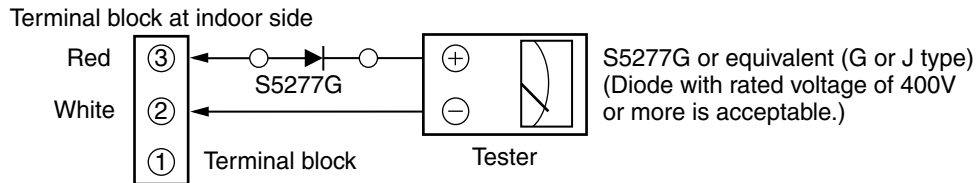

Normal time : Voltage swings between DC15 and 60V.

Abnormal time : Voltage does not vary.

(2) Outdoor unit stops in a little while after operation started

<Check procedure> Select phenomena described below.

- (1) The outdoor unit stops 10 to 20 minutes after operation started, and 10 minutes or more are required to restart the unit.

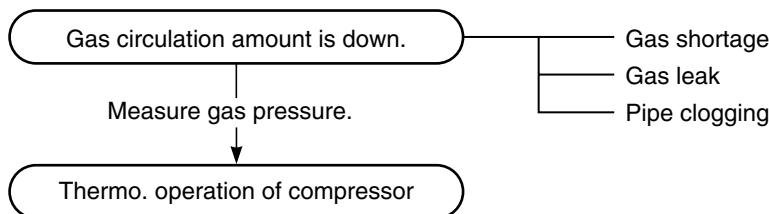

- (2) If the unit stops once, it does not operate until the power will be turned on again.

To item of Compressor does not operate.

- (3) The outdoor unit stops 10 minutes to 1 hour after operation started, and an alarm is displayed.
(Discharge temp. error check code 03, 1E Sensor temp. error check code 02, 1C)

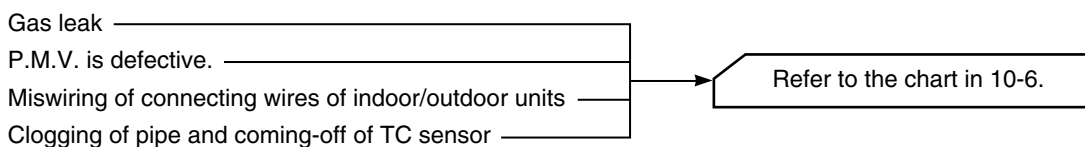

10-6. Check Code 1C (Miswiring in indoor/outdoor units) and 1E

<Check procedure>

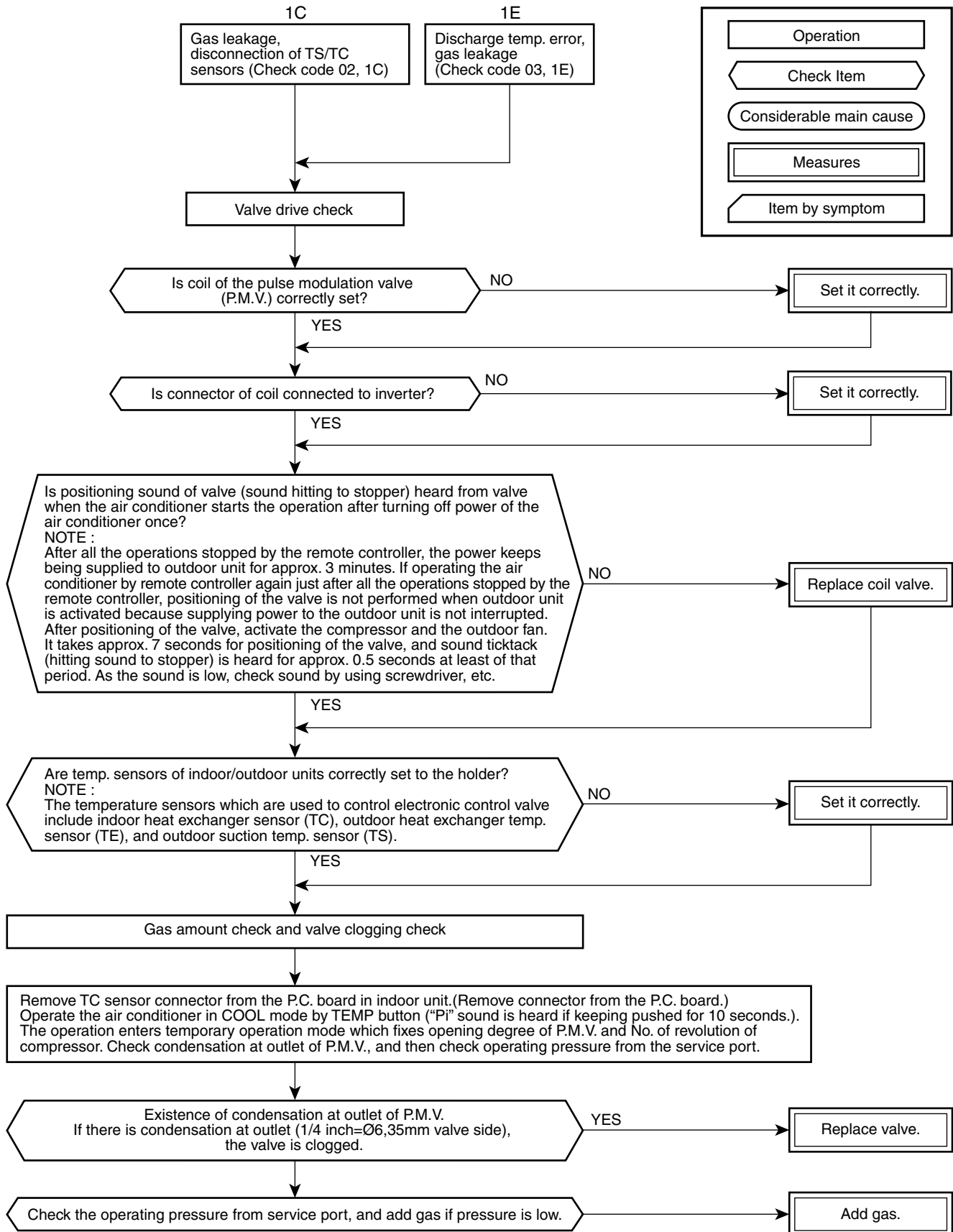

10-7. How to Diagnose Trouble in Outdoor Unit

10-7-1. Summarized Inner Diagnosis of Inverter Assembly

Diagnosis/Process flowchart	Item	Contents	Summary
<pre> graph TD Start([Remove connector of compressor.]) --> F01{Check 25A fuse (Part No.F01).} F01 -- NG --> RFuse[Replace fuse.] RFuse --> DB01{Check electrolytic capacitor, diode block (DB01), etc.} DB01 -.-> F01 F01 -- OK --> F03{Check 15A fuse (Part No.F03).} F03 -- NG --> RCB[Replace control board assembly.] F03 -- OK --> Vcap{Check terminal voltage of electrolytic capacitor.} Vcap -- NG --> DB01_2{Check electrolytic capacitor, diode (DB01), etc.} DB01_2 -.-> Vcap Vcap -- OK --> Fan{Does outdoor fan rotate?} Fan -- NO --> LED{Does LED on control board flash or go on?} LED -- YES --> C([C]) LED -- NO --> R300[Remove connector CN300 of outdoor fan motor, and using a tester, check resistance value between every phases at motor side.] R300 -- NG --> RFM[Replace outdoor fan motor.] R300 -- OK --> B([B]) Fan -- YES --> A([A]) </pre>	<p>Preparation</p> <p>Check</p> <p>Check</p> <p>Operation</p> <p>Measurement</p> <p>Check</p> <p>Stop</p> <p>Check Measurement</p>	<p>Turn "OFF" the power breaker, and remove 3P connector which connects inverter and compressor.</p> <ul style="list-style-type: none"> Check whether 25A fuse on the control board assembly is blown or not. (F01) <p>Check whether 15A fuse on the control board assembly is blown or not. (F03)</p> <ul style="list-style-type: none"> 15A fuse (F03) on the control board is provided for power factor improvement control circuit. The operation continues even if fuse is blown. <p>Turn on power breaker, and operate the air conditioner in COOL mode by short-circuit of the timer.</p> <p>Measure terminal voltage of the electrolytic capacity.</p> <div style="border: 1px solid black; padding: 2px; width: fit-content;">500μF:400WV x 3</div> <p>After operation, turn off the power breaker after 2 minutes 20 seconds passed, and discharge the electrolytic capacity by soldering iron. Check voltage between motor phases.</p> <ul style="list-style-type: none"> Is not winding between ①-②, ②-③, or ①-③ opened or short-circuited? Is not frame grounded with ①, ②, or ③? 	<p>If fuse was blown, be sure to check the electrolytic capacitor and diode block. (DB01)</p> <ul style="list-style-type: none"> Connect discharge resistance (approx. 100Ω/40W) or soldering iron (plug) between +, - terminals of the electrolytic capacitor (500μF) of C14 (with printed CAUTION HIGH VOLTAGE) on P.C. board. <p>If 15A fuse is blown, discharge both edges of the electrolytic capacitor with soldering iron.</p> <p>OK if 500μF → DC280 to 320V</p> <p>Remove CN300 while pushing the part indicated by an arrow because CN01 is a connector with lock.</p> <p>→ Resistance between phases should be approx. 55 to 77Ω</p> <p>→ Should be 10MΩ or more.</p>

Diagnosis/Process flowchart	Item	Contents	Summary
<pre> graph TD A((A)) --> RCB[Replace control board.] B((B)) --> CFS[Check fan motor position detect signal.] C((C)) --> CWR[Check winding of compressor.] CFS -- NG --> ROFM[Replace outdoor fan motor.] CFS -- OK --> RCB_A[Replace control board assembly.] CWR -- NG --> RC[Replace compressor.] CWR -- OK --> RCB_A RCB_A -- NG --> CWR RCB_A -- OK --> RCB CWR -- OK --> RCB CWR -- NG --> RC </pre>	<p>Check</p> <p>Operation</p> <p>Check</p>	<p>Check winding resistance between phases of compressor, and resistance between outdoor frames by using a tester.</p> <ul style="list-style-type: none"> • Is not grounded. • Is not short-circuited between windings. • Winding is not opened. <p>Remove connector CN300 of the outdoor fan motor, turn on the power breaker, and perform the operation. (Stops though activation is prompted.) Check operation within 2 minutes 20 seconds after activation stopped.</p> <p><Output check of fan motor position detect signal> While connecting connector 5P (CN301) for position detection, using a tester, measure voltage between ① - ⑤. Between ⑤ - ④ : 5V</p>	<p>→ OK if 10MΩ or more } → OK if 0,51Ω → 0,57Ω (Check by a digital tester.)</p> <p>a) One or two of three voltages should be 5V, and others should be 0V. (When all are 0V or 5V, it is not accepted.) b) When rotating the fan slowly with hands, the voltage between pins should move from 0V to 5V. (Check it with an analog tester.)</p>

10-8. How to Check Simply the Main Parts

10-8-1. How to Check the P.C. Board (Indoor Unit)

(1) Operating precautions

- 1) When removing the front panel or the P.C. board, be sure to shut off the power supply breaker.
- 2) When removing the P.C. board, hold the edge of the P.C. board and do not apply force to the parts.
- 3) When connecting or disconnecting the connectors on the P.C. board, hold the whole housing. Do not pull at the lead wire.

(2) Inspection procedures

- 1) When a P.C. board is judged to be defective, check for disconnection, burning, or discoloration of the copper foil pattern or this P.C. board.
- 2) The P.C. board consists of the following 2 parts

a. Main P.C. board part:

DC power supply circuit (5V, 12V, 35V), Indoor fan motor control circuit, CPU and peripheral circuits, buzzer, and Driving circuit of top/bottom louvers

b. Indication unit of infrared ray receiving Infrared ray receiving circuit, LED:

To check defect of the P.C. board, follow the procedure described below.

(3) Check procedures

Table 10-8-1

No.	Procedure	Check point (Symptom)	Causes
1	Shut off the power supply and remove the P.C. board assembly from the electronic parts base. Remove the connecting cable from the terminal block.	1. Is the fuse blown?	1. * Application of shock voltage. * Overload by short-circuit of the parts.
2	Remove the connector for the motor, and turn the power on. If the OPERATION lamp flashes (0,5 sec. :ON, 0,5 sec. :OFF) when the power turning on, the checking points described as 1-5 of right column are not necessary to perform.	Voltage check 1. Between TP1 and TP2 (220–230–240V AC) 2. Between TP2 and pin 1 of CN04 (220–230–240V AC) 3. Between TP2 and pin 3 of CN04 (220–230–240V AC) 4. Between + and – of C02 (310 ~ 340V DC) 5. Between 35V and GND 6. Between 12V and GND 7. Between 5 V and GND	1. * AC power cord is defective. * Poor contact of the terminal plate. * Miss wiring of the power relay. 2. Fuse is defective. 3. Operation of the thermal fuse. 4. * Capacitor (C01, C15) is defective. * Line filter (L01) is defective. * Resistor (R01) is defective. * Diode (DB01) is defective. 5. IC01, IC02, T01 are defective. 6. IC01, IC02, T01, F03 are defective. 7. IC01, IC02, T01, F02, Q29, IC03 are defective.
3	Make the operation status by pushing once the START/STOP button, except the status of [ON TIMER].	Voltage check 1. Voltage of relay coil. (DC 12V) Between pin 10 of IC31 and GND Between pin 11 of IC31 and GND 2. Between No. 1 and 2 of connecting cable terminal block. (220–230–240V AC)	1. Breaking wire of the relay coil, defective relay driver. (IC31) 2. Poor contact of relay.
4	Start the operation with the system which the time of the restart delay timer is shortened.	1. All indicators light for 3 sec. 2. Indicators do not indicate normally after approximate 3 sec.	} Defective indicator, or poor housing assembly. (CN13)
5	Make the operation status by pressing once the START/STOP button. 1. The time of the restart delay timer is shortened. 2. Cool operation 3. Air volume [AUTO] 4. Make the setting temperature lower enough than room temperature. 5. Continuous operation.	1. Compressor does not operate. 2. OPERATION lamp flashes.	1. The temperature of the indoor heat exchanger is abnormally low. 2. Poor contact of the heat exchanger sensor. (The connector is disconnected.) (CN01) 3. Heat exchanger sensor, main P.C. board are defective. 4. Main P.C. board is defective.
6	Turn the power on after connecting the motor connector. Start the operation with the following condition. 1. Operation [Cooling] 2. Airflow [High fan] 3. Continuous operation	1. The voltage of DC 35V is not measured between the red and black of the motor terminals. 2. Motor does not rotate. (The key operation is accepted.) 3. The motor rotates, but it vibrates too much.	1. Indoor fan motor is defective. (Protecting operation on the P.C. board.) 2. Poor contact of the motor connector. 3. P.C. board is defective.

10-8-2. P.C. Board Layout

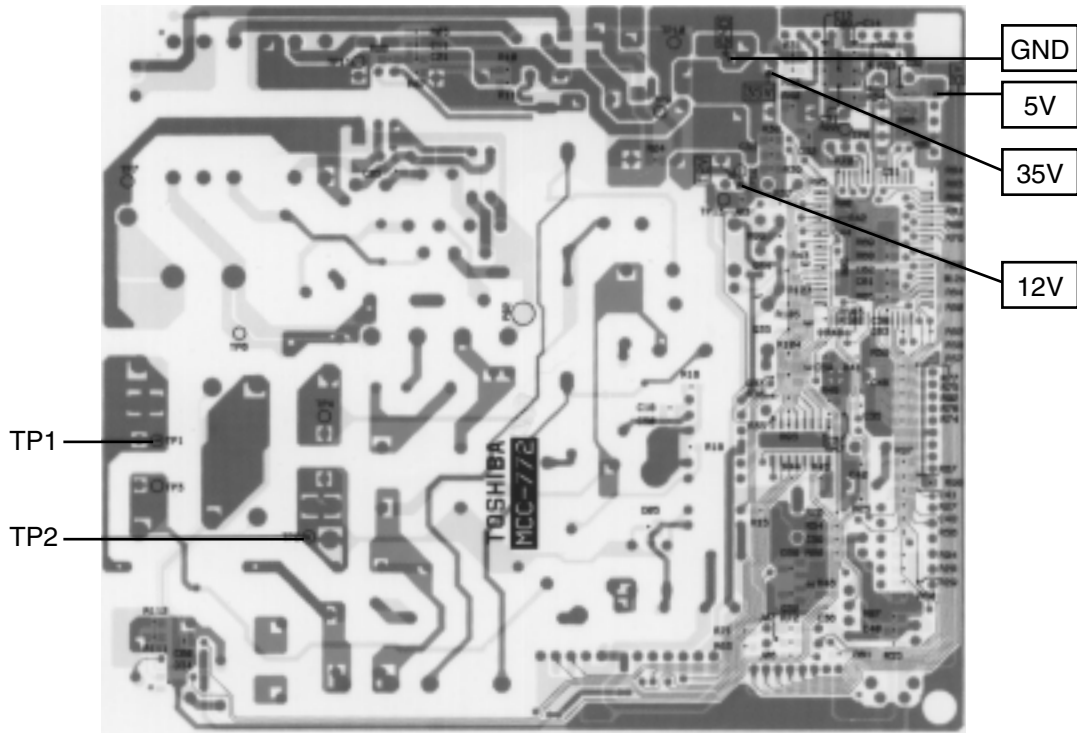

Bottom View

(For the Top View, refer to page 61.)

[1] Sensor characteristic table

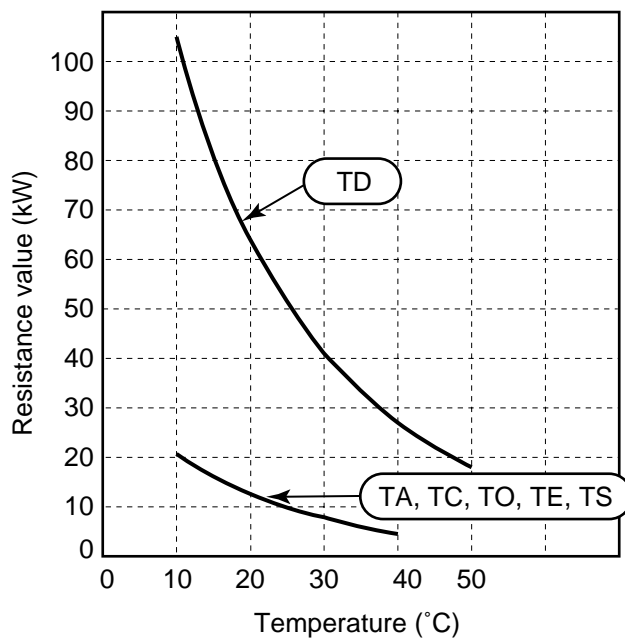

- TD : Discharge temp. sensor
- TA : Room temp. sensor
- TC : Heat exchanger temp. sensor
- TO : Outdoor temp. sensor
- TE : Outdoor heat exchanger temp. sensor
- TS : Suction temp. sensor

10-8-3. Indoor Unit (Other Parts)

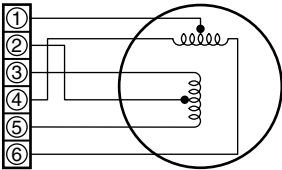
No.	Part name	Checking procedure																		
1	Room temp. (TA) sensor Heat exchanger (TC) sensor	Disconnect the connector and measure the resistance value with tester. (Normal temp.) <table border="1" style="margin-left: 20px;"> <thead> <tr> <th style="border: none;">Temperature</th> <th>10°C</th> <th>20°C</th> <th>25°C</th> <th>30°C</th> <th>40°C</th> </tr> </thead> <tbody> <tr> <td style="border: none;">Sensor</td> <td></td> <td></td> <td></td> <td></td> <td></td> </tr> <tr> <td style="border: none;">TA, TC (kΩ)</td> <td>20,7</td> <td>12,6</td> <td>10,0</td> <td>7,9</td> <td>4,5</td> </tr> </tbody> </table>	Temperature	10°C	20°C	25°C	30°C	40°C	Sensor						TA, TC (kΩ)	20,7	12,6	10,0	7,9	4,5
Temperature	10°C	20°C	25°C	30°C	40°C															
Sensor																				
TA, TC (kΩ)	20,7	12,6	10,0	7,9	4,5															
2	Remote controller	To item of How to judge whether remote controller is good or bad of the Judgment of trouble by symptom.																		
3	Louver motor MP35EA7	Measure the resistance value of each winding coil by using the tester. (Under normal temp. 25°C) <div style="display: flex; align-items: center; margin-left: 20px;"> <div style="margin-right: 10px;"> Brown ① Red ② Orange ③ Yellow ④ Pink ⑤ Blue ⑥ </div>  <table border="1" style="margin-left: 20px;"> <thead> <tr> <th>Position</th> <th>Resistance value</th> </tr> </thead> <tbody> <tr> <td>1 to 4</td> <td rowspan="5" style="text-align: center; vertical-align: middle;">130 ± 10 Ω</td> </tr> <tr> <td>1 to 6</td> </tr> <tr> <td>2 to 3</td> </tr> <tr> <td>2 to 5</td> </tr> <tr> <td>2 to 6</td> </tr> </tbody> </table> </div>	Position	Resistance value	1 to 4	130 ± 10 Ω	1 to 6	2 to 3	2 to 5	2 to 6										
Position	Resistance value																			
1 to 4	130 ± 10 Ω																			
1 to 6																				
2 to 3																				
2 to 5																				
2 to 6																				
4	Indoor fan motor	Since judgment of DC motor is difficult on the single motor, refer to 10-5-1. (3).																		

10-8-4. Outdoor Unit

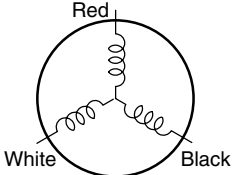
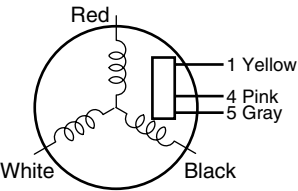
No.	Part name	Checking procedure																		
1	Compressor (Model : DA91A1F-44F)	Measure the resistance value of each winding by using the tester. <div style="display: flex; align-items: center; margin-left: 20px;">  <table border="1" style="margin-left: 20px;"> <thead> <tr> <th>Position</th> <th>Resistance value</th> </tr> </thead> <tbody> <tr> <td>Red - White</td> <td>0,51 to 0,57 Ω</td> </tr> <tr> <td>White - Black</td> <td>0,51 to 0,57 Ω</td> </tr> <tr> <td>Black - Red</td> <td>0,51 to 0,57 Ω</td> </tr> </tbody> </table> </div> <p style="text-align: right; margin-right: 20px;">Under 20°C</p>	Position	Resistance value	Red - White	0,51 to 0,57 Ω	White - Black	0,51 to 0,57 Ω	Black - Red	0,51 to 0,57 Ω										
Position	Resistance value																			
Red - White	0,51 to 0,57 Ω																			
White - Black	0,51 to 0,57 Ω																			
Black - Red	0,51 to 0,57 Ω																			
2	Outdoor fan motor (Model : ICF-140-40-7)	Measure the resistance value of winding by using the tester. <div style="display: flex; align-items: center; margin-left: 20px;">  <table border="1" style="margin-left: 20px;"> <thead> <tr> <th>Position</th> <th>Resistance value</th> </tr> </thead> <tbody> <tr> <td>Yellow- Pink</td> <td>5 to 20 k Ω</td> </tr> </tbody> </table> </div> <p style="text-align: right; margin-right: 20px;">For details, refer to Section 10-9.</p>	Position	Resistance value	Yellow- Pink	5 to 20 k Ω														
Position	Resistance value																			
Yellow- Pink	5 to 20 k Ω																			
3	Compressor thermo. Bimetal type (Model : PW - 2AL)	Check conduction by using the tester.																		
4	Outdoor temperature sensor (TO), discharge temperature sensor (TD), suction temperature sensor (TS), outdoor heat exchanger temperature sensor (TE)	Disconnect the connector, and measure resistance value with the tester. (Normal temperature) <table border="1" style="margin-left: 20px;"> <thead> <tr> <th style="border: none;">Temperature</th> <th>10°C</th> <th>20°C</th> <th>30°C</th> <th>40°C</th> <th>50°C</th> </tr> </thead> <tbody> <tr> <td style="border: none;">Sensor</td> <td></td> <td></td> <td></td> <td></td> <td></td> </tr> <tr> <td style="border: none;">TD (kΩ)</td> <td>105</td> <td>64</td> <td>41</td> <td>27</td> <td>18</td> </tr> </tbody> </table> <p>TGa : Heat pump model only.</p> <p>TO, TS, TE : Refer to the TA, TC characteristic table in Indoor (Refer to Table 10-8-3, No. 1).</p>	Temperature	10°C	20°C	30°C	40°C	50°C	Sensor						TD (kΩ)	105	64	41	27	18
Temperature	10°C	20°C	30°C	40°C	50°C															
Sensor																				
TD (kΩ)	105	64	41	27	18															

10-8-5. Checking Method for Each Part

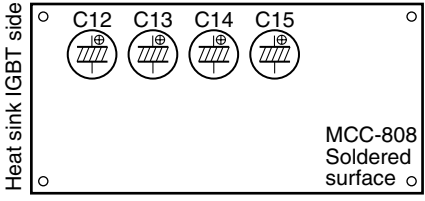
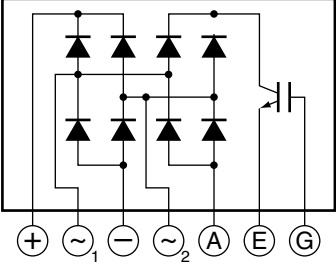
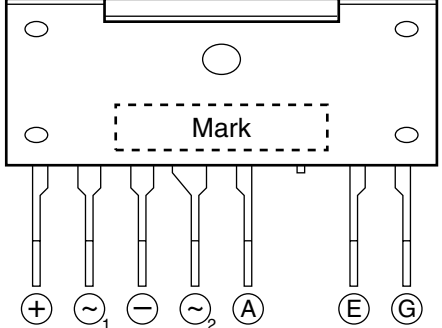
No.	Part name	Checking procedure																																			
1	Electrolytic capacitor (For raising pressure, smoothing)	<ol style="list-style-type: none"> 1. Turn OFF the power supply breaker. 2. Discharge all four capacitors completely. 3. Check that safety valve at the bottom of capacitor is not broken. 4. Check that vessel is not swollen or exploded. 5. Check that electrolytic liquid does not blow off. 6. Check that the normal charging characteristics are shown in continuity test by the tester. <div style="display: flex; justify-content: space-around; align-items: flex-start;"> <div style="border: 1px solid black; padding: 5px;">  </div> <div style="border: 1px solid black; padding: 5px;"> <p>Case that product is good</p> <p>Pointer swings once, and returns slowly. When performing test once again under another polarity, the pointer should return.</p> </div> </div> <p>C12, C13, C14 → 500μF/400V</p>																																			
2	Converter module	<ol style="list-style-type: none"> 1. Turn OFF the power supply breaker. 2. Discharge all four capacitors completely. 3. Check that the normal rectification characteristics are shown in continuity test by the tester. <div style="display: flex; justify-content: space-around; align-items: flex-start;"> <div style="border: 1px solid black; padding: 5px;">  </div> <div style="border: 1px solid black; padding: 5px;">  </div> </div> <div style="display: flex; justify-content: space-around; margin-top: 10px;"> <div style="border: 1px solid black; padding: 5px;"> <p style="text-align: center;">Diode check</p> <table border="1" style="width: 100%; border-collapse: collapse;"> <thead> <tr> <th colspan="2">Tester rod</th> <th rowspan="2">Resistance value in good product</th> </tr> </thead> <tbody> <tr> <td style="text-align: center;">+</td> <td style="text-align: center;">-</td> <td rowspan="6" style="text-align: center; vertical-align: middle;">50kΩ or more (0Ω in trouble)</td> </tr> <tr> <td style="text-align: center;">~₁</td> <td style="text-align: center;">-</td> </tr> <tr> <td style="text-align: center;">~₂</td> <td style="text-align: center;">-</td> </tr> <tr> <td style="text-align: center;">+</td> <td style="text-align: center;">~₁</td> </tr> <tr> <td style="text-align: center;">+</td> <td style="text-align: center;">~₂</td> </tr> <tr> <td style="text-align: center;">E</td> <td style="text-align: center;">~₁</td> </tr> <tr> <td style="text-align: center;">E</td> <td style="text-align: center;">~₂</td> <td></td> </tr> </tbody> </table> </div> <div style="border: 1px solid black; padding: 5px;"> <p style="text-align: center;">IGBT check</p> <table border="1" style="width: 100%; border-collapse: collapse;"> <thead> <tr> <th colspan="2">Tester rod</th> <th rowspan="2">Resistance value in good product</th> </tr> </thead> <tbody> <tr> <td style="text-align: center;">+</td> <td style="text-align: center;">-</td> <td rowspan="6" style="text-align: center; vertical-align: middle;">50kΩ or more (0Ω in trouble)</td> </tr> <tr> <td style="text-align: center;">~₂</td> <td style="text-align: center;">E</td> </tr> <tr> <td style="text-align: center;">G</td> <td style="text-align: center;">E</td> </tr> <tr> <td style="text-align: center;">~₁</td> <td style="text-align: center;">A</td> </tr> <tr> <td style="text-align: center;">~₂</td> <td style="text-align: center;">A</td> </tr> <tr> <td style="text-align: center;">~₂</td> <td style="text-align: center;">A</td> </tr> </tbody> </table> </div> </div>	Tester rod		Resistance value in good product	+	-	50kΩ or more (0Ω in trouble)	~ ₁	-	~ ₂	-	+	~ ₁	+	~ ₂	E	~ ₁	E	~ ₂		Tester rod		Resistance value in good product	+	-	50kΩ or more (0Ω in trouble)	~ ₂	E	G	E	~ ₁	A	~ ₂	A	~ ₂	A
Tester rod		Resistance value in good product																																			
+	-		50kΩ or more (0Ω in trouble)																																		
~ ₁	-																																				
~ ₂	-																																				
+	~ ₁																																				
+	~ ₂																																				
E	~ ₁																																				
E	~ ₂																																				
Tester rod		Resistance value in good product																																			
+	-		50kΩ or more (0Ω in trouble)																																		
~ ₂	E																																				
G	E																																				
~ ₁	A																																				
~ ₂	A																																				
~ ₂	A																																				

10-9. How to Simply Judge Whether Outdoor Fan Motor is Good or Bad

1. Symptom

- Outdoor fan motor does not rotate.
- Outdoor fan motor stops within several tens seconds though it started rotating.
- Outdoor fan motor rotates or does not rotate according to the position where the fan stopped., etc.

Remote controller check code “02 : Outdoor block, 1A : Outdoor fan drive system error”

2. Cause

The following causes are considered when the outdoor fan motor does not normally rotate.

- 1) Mechanical lock of the outdoor fan motor
 - 2) Winding error of the outdoor fan motor
 - 3) Position-detect circuit error inside of the outdoor fan motor
- or
- 4) Motor drive circuit error of the outdoor P.C. board

3. How to simply judge whether outdoor fan motor is good or bad

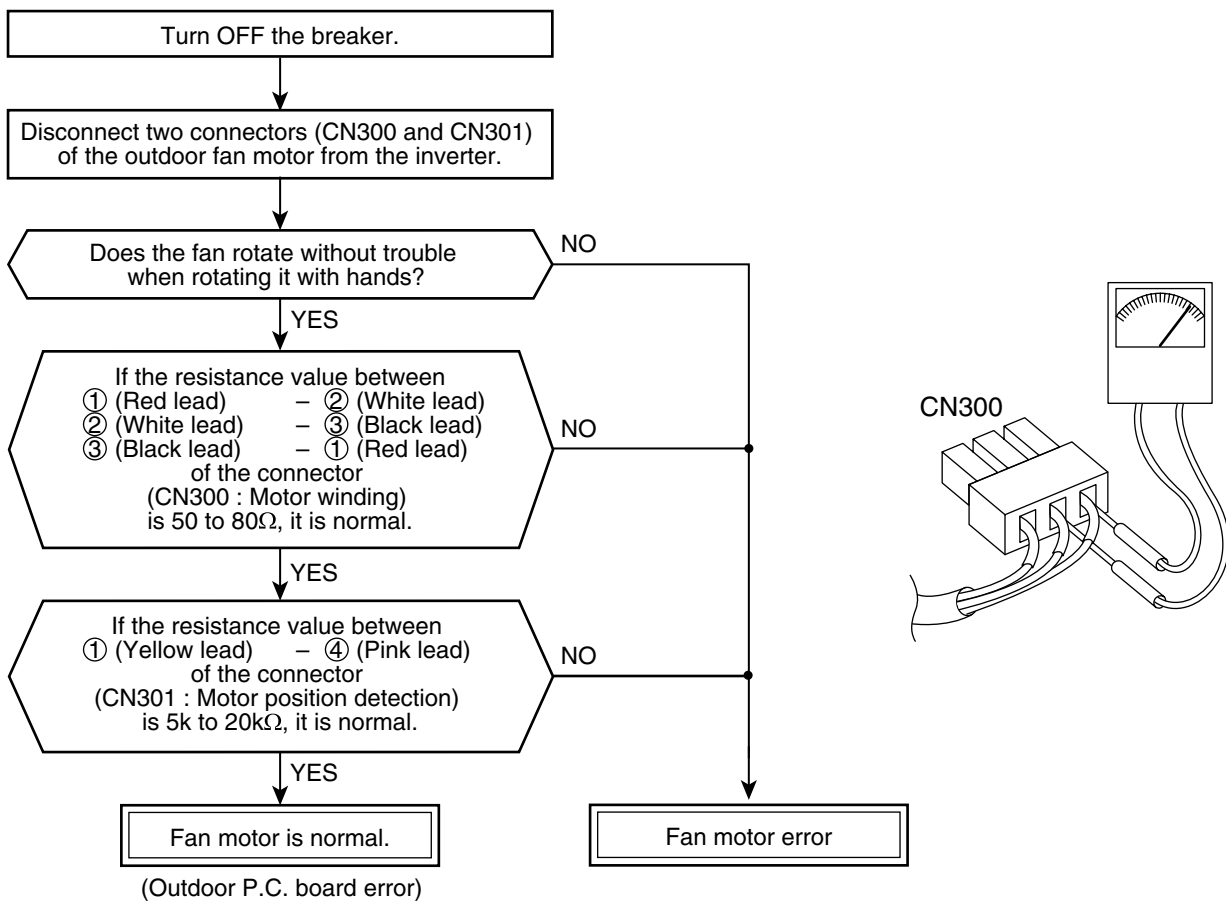

NOTE :



However, GND circuit error inside of the motor may be accepted in some cases when the above check is performed.

When the fan motor does not become normal even if P.C. board is replaced, replace the outdoor fan motor.

11. HOW TO REPLACE THE MAIN PARTS

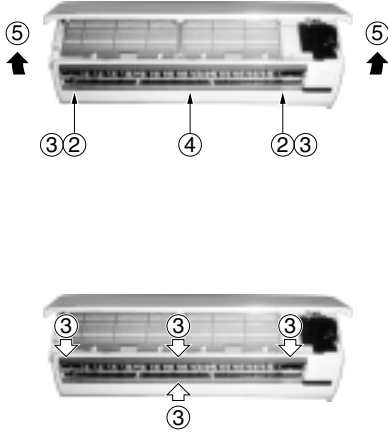
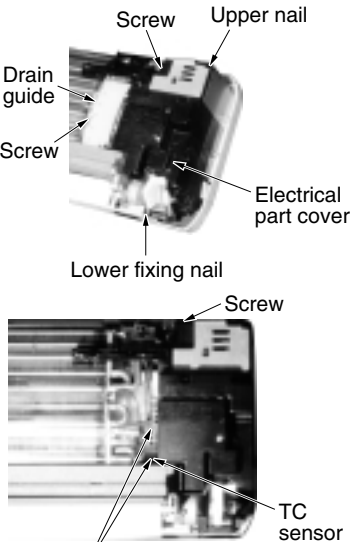
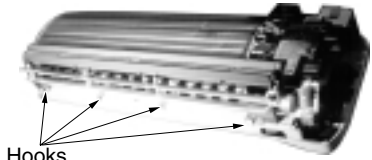
11-1. Indoor Unit

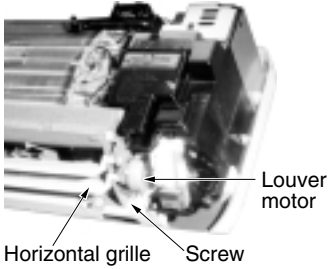
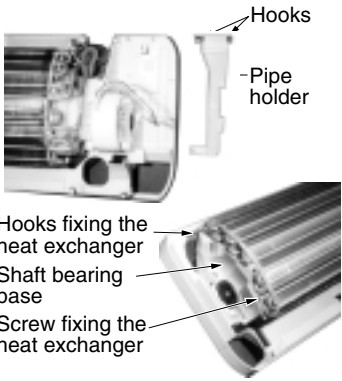
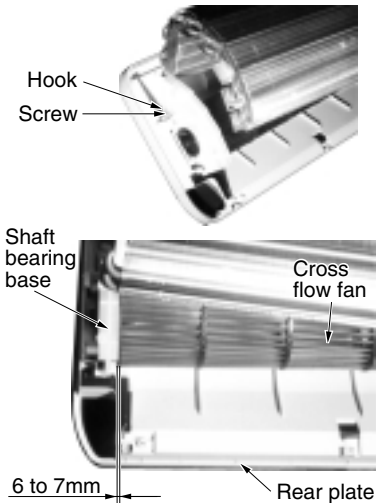
No.	Part name	Procedure	Remarks
①	Front panel	<ol style="list-style-type: none"> 1) After stopping the operation of the air conditioner, be sure to turn off the circuit breaker or disconnect the power plug from the AC wall socket. 2) Open the screw caps and remove the two screws fixing the front panel. 3) Close the screw caps as they were. 4) Open the horizontal louver right below by your finger. 5) Open the lower side of front panel until it touches the horizontal louver, and remove it from the indoor unit by turning it. <p><To assemble the front panel></p> <ol style="list-style-type: none"> 1) Fix the two screws to secure the front panel. 2) Close the screw caps as they were. 3) Press four places where are the center, right end, left end and lower portions of the air outlet. 4) Check the gap between the front panel and the main unit. <p>If cooling or drying operation is performed without pressing the center of the air outlet, the surface of the front panel may be covered with frost and have a waterdrop.</p>	
②	Electrical part assembly	<ol style="list-style-type: none"> 1) Perform the process ① above. 2) Remove the screw securing the shield metal plate. 3) Remove the electrical part cover by pressing the nail located on upper portion of the electrical part cover. 4) Remove the drain guide. 5) Remove the screw securing to the end plate of the heat exchanger. 6) Remove the connector (5p) for the fan motor and the connector (6p) for the louver motor from the microcomputer assembly. 7) After unhooking the electrical part base by pressing the fixing nail located on its lower portion, draw the electrical part base out toward you to remove it from the main unit. 8) Pull the TC sensor out from the holder of the heat exchanger. 9) Dress the connecting cable securely as shown in the right illustration. (Improper dressing will cause water leakage.) 	 <p>When assembling dress the connecting cable in loop and put it into the drain-pan.</p>
③	Drain-pan assembly	<ol style="list-style-type: none"> 1) Perform the process ② above. 2) Remove the drain-pan by pressing the four hooks downwards. (Keep it with the drain hose.) 	

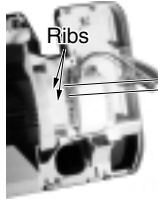
No.	Part name	Procedure	Remarks
④	Horizontal grille Note: The horizontal grille can not be removed without removing the louver motor.	<ol style="list-style-type: none"> 1) Perform the process ②. 2) Remove the screw fixing the louver motor, and remove the louver motor. 3) Remove the shaft of the horizontal grille from the drain-pan. 	
⑤	Heat exchanger	<ol style="list-style-type: none"> 1) Perform the process ③. 2) Remove the pipe holder from the rear side of main unit by removing the screw. 3) Unhook the hooks fixing the left side of the heat exchanger and remove the screw fixing it, then remove the right side of the end plate from the rib fixing the main unit by sliding the heat exchanger slightly to the right side. 	
⑥	Cross flow fan	<ol style="list-style-type: none"> 1) Perform the process ③. 2) Loosen the set screw of the cross flow fan. 3) Remove the screw fixing the shaft bearing base. 4) Lift slightly up the left side of the heat exchanger, and pull the shaft bearing base out left downwards. <p>When assembling it, fix it with the set screw on the position where the gap between the rear plate surface and the left end surface of the cross flow fan is 6 to 7 mm.</p>	
⑦	Shaft bearing	<ol style="list-style-type: none"> 1) Perform the process ⑥ above. 2) Remove the shaft bearing from the shaft bearing base. <p><Caution for assembling></p> <ul style="list-style-type: none"> • If a part of the shaft bearing is protruded from the housing, assemble it after pushing its portion into the correct position in the housing. 	
⑧	Fan motor	<ol style="list-style-type: none"> 1) Perform the process ⑤ above. 2) Perform the process ⑥-2) above. 3) Remove the left and right motor bands. 4) Remove the fan motor after pulling the cross flow fan out sliding it left and right. 	 <p>Mount the fan motor as shown in figure below when assembling.</p> <p>Put the end of lead wire at the portion between two ribs.</p>

11-2. Microcomputer

No.	Part name	Procedure	Remarks
①	Common procedure	1) Turn the power supply off to stop the operation of air-conditioner. 2) Remove the front panel. • Remove the two fixing screws. (Ø4 x 14ℓ) 3) Remove the electrical part base.	Replace the thermal fuse, terminal block, microcomputer ass'y and the P.C. board ass'y.

<P.C. board layout>

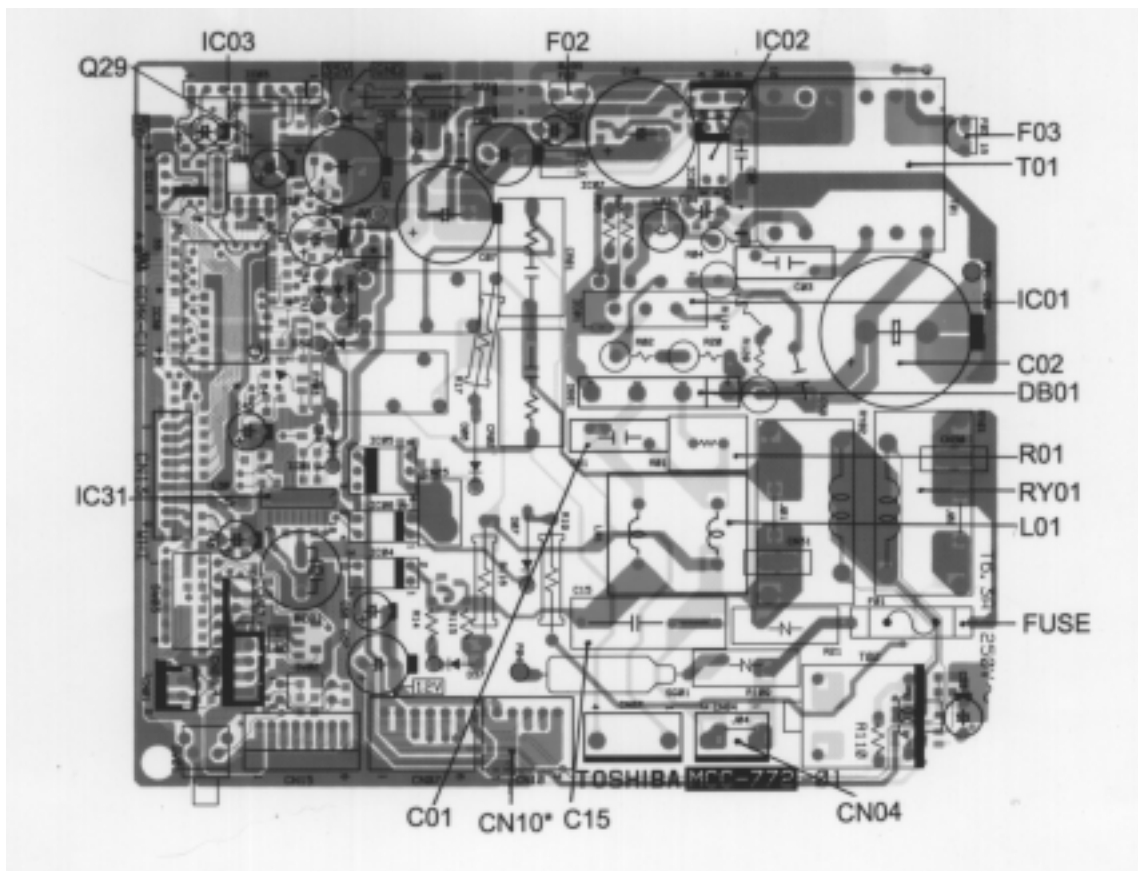

11-3. Outdoor Unit

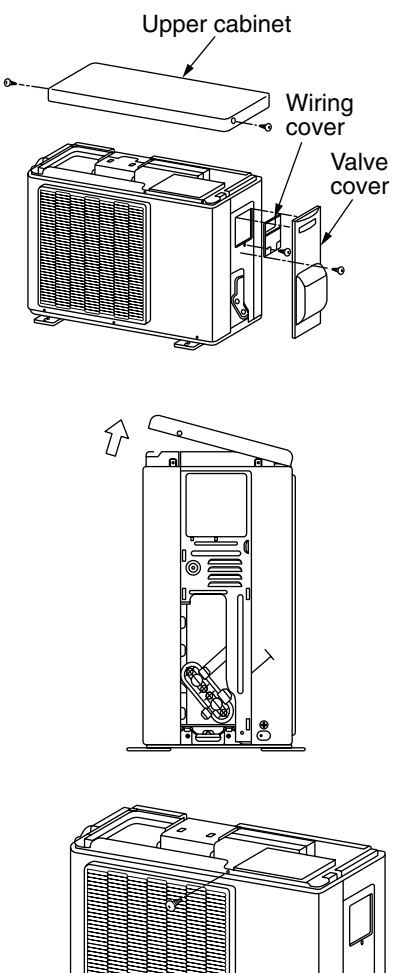
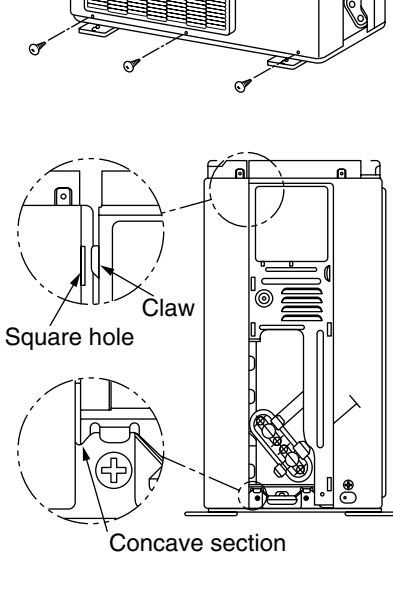
No.	Part name	Procedure	Remarks
①	Common procedure	<p>1. Detachment</p> <ol style="list-style-type: none"> 1) Stop operation of the air conditioner, and remove the power plug of the indoor unit from plug socket. 2) Remove the valve cover. (ST1TØ4 x 10ℓ 1 pc.) <ul style="list-style-type: none"> • After removing screw, remove the valve cover pulling it downward. 3) Remove wiring cover (ST1TØ4 x 10ℓ 2 pcs.), and then remove connecting cable. 4) Remove the upper cabinet. (ST1TØ4 x 10ℓ 2 pcs.) <ul style="list-style-type: none"> • After removing screws, remove the upper cabinet pulling it upward. <p>2. Attachment</p> <ol style="list-style-type: none"> 1) Attach the upper cabinet. (ST1TØ4 x 10ℓ 2 pcs.) <ul style="list-style-type: none"> • Hook the rear side of the upper cabinet to claw of the rear cabinet, and then put it on the front cabinet. 2) Perform cabling of connecting cable, and attach the wiring cover. <ul style="list-style-type: none"> • Insert the upper part into the upper cabinet, insert claw which has been hooked to the lower part into the square hole, and then fix it with screw. (ST1TØ4 x 10ℓ 1 pc.) 3) Attach the valve cover. (ST1TØ4 x 10ℓ 1 pc.) <ul style="list-style-type: none"> • Insert the upper part to the upper cabinet, set hook claw of the valve cover to square holes (at three positions) of the main unit, and attach it pushing upward. 	
②	Front cabinet	<p>1. Detachment</p> <ol style="list-style-type: none"> 1) Perform work of item 1 of ①. 2) Remove screws (ST1TØ4 x 10ℓ 1 pc.) of the front cabinet and inverter cover and screws (ST1TØ4 x 10ℓ 3 pcs.) of the front cabinet and lower part. <ul style="list-style-type: none"> • The left side of the front is made to insert to the rear cabinet, so remove it pulling upward. <p>2. Attachment</p> <ol style="list-style-type: none"> 1) Insert claw at the left side of the front into the rear cabinet. 2) Hook the lower part at the right side of the front to concave part of the bottom plate. Insert claw of the rear cabinet into square hole of the front cabinet. 3) Attach the removed screws to the original positions. 	

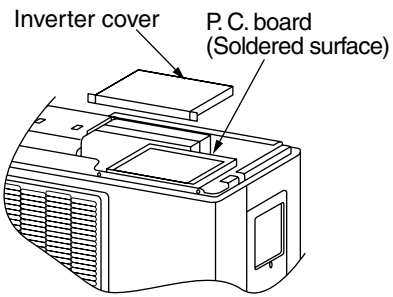
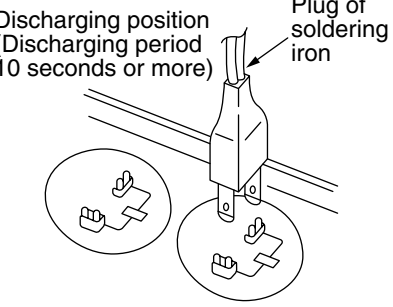
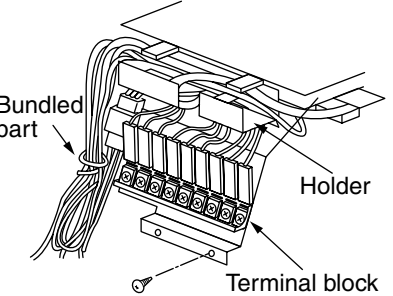
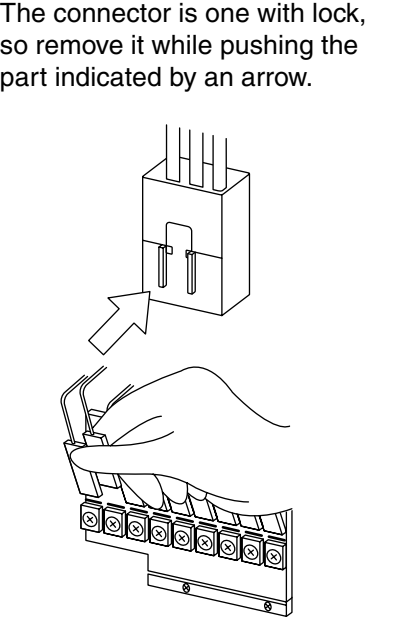
No.	Part name	Procedure	Remarks
③	Inverter assembly	<p>1. Detachment</p> <ol style="list-style-type: none"> 1) Perform work of item 1 of ①. 2) Remove screw (ST1TØ4 x 10ℓ 1 pc.) of the upper part of the front cabinet. <ul style="list-style-type: none"> • If removing the inverter cover in this condition, P.C. board can be checked. • If there is no space in the upper part of the upper cabinet, perform work of ②. <div style="border: 1px solid black; padding: 5px; margin: 10px 0;"> <p>Be careful to check the inverter because high-voltage circuit is incorporated in it.</p> </div> <ol style="list-style-type: none"> 3) Perform discharging by connecting ⊕, ⊖ polarity by discharging resistance (approx. 100Ω40W) or plug of soldering iron to ⊕, ⊖ terminals of the C14 (printed "CAUTION HIGH VOLTAGE" is attached.) electrolytic capacitor (500μF) on P.C. board. <div style="border: 1px solid black; padding: 5px; margin: 10px 0;"> <p>Be careful to discharge the capacitor because the electrolytic capacitor cannot naturally discharge and voltage remains according to trouble type in some cases.</p> </div> <div style="border: 1px solid black; padding: 5px; margin: 10px 0;"> <p>NOTE : This capacitor is one with mass capacity. Therefore, it is dangerous that a large spark generates if short-circuiting between ⊕, ⊖ polarity with screwdriver, etc. for discharging.</p> </div> 4) Remove screw (ST1TØ4 x 10ℓ 1 pc.) fixing the main body and the inverter box. 5) Remove various lead wires from the holder at upper part of the inverter box and wiring holder at right side of the terminal block. 6) Remove the lead wire from the bundled part at left side of the terminal block. 7) Pull the inverter box upward. 8) Disconnect connectors of various lead wires. <div style="border: 1px solid black; padding: 5px; margin: 10px 0;"> <p>Requirement : As each connector has a lock mechanism, avoid to remove the connector by holding the lead wire, but by holding the connector.</p> </div>	 <p>Inverter cover P.C. board (Soldered surface)</p>  <p>Discharging position (Discharging period 10 seconds or more) Plug of soldering iron</p>  <p>Bundled part Holder Terminal block</p> <p>The connector is one with lock, so remove it while pushing the part indicated by an arrow.</p>  <p>Be sure to remove the connector by holding the connector, not by pulling the lead wire.</p>

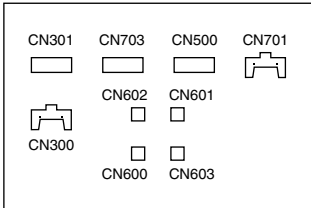
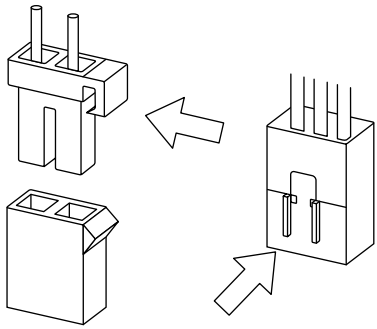
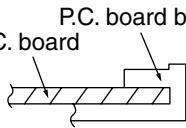
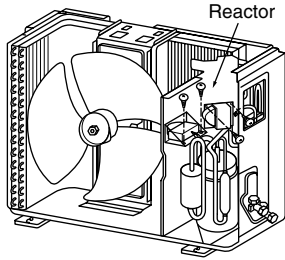
No.	Part name	Procedure	Remarks
④	Control board assembly	<p>1) Disconnect lead wires and connectors connected from the control board assembly to other parts.</p> <p>1. Lead wires</p> <ul style="list-style-type: none"> • Connection with terminal block : 3 wires (Black, White, Orange) • Connection with compressor : Remove the connector (3P). • Connection with reactor : Remove the relay connectors from P07, 08 (2P, White) and P12, 13 (2P, Yellow). <p>2. Connectors</p> <p>CN300 : Outdoor fan (3P, White) CN301 : Outdoor fan position detection (5P, White) CN701 : 4 valve (3P, Yellow) CN600 : TE sensor (2P, White) CN601 : TD sensor (3P, White) CN603 : TS sensor (3P, White) CN602 : TO sensor (2P, White) CN500 : Case thermo. (2P, White) CN703 : Pulse modulating valve (6P, White)</p> <p>2) Remove the control board assembly from P.C. board base.</p> <p>1. Main control board assembly side</p> <ul style="list-style-type: none"> • Remove two claws of P.C. board base, and remove upward the heat sink with hands. • Remove three screws fixing the heat sink and main control board assembly side, and replace the board with a new one. 	 <p>CN300, CN301 and CN701, etc. at the control board assembly side are connectors with locks. Therefore, remove the connector while pushing the part indicated by an arrow.</p>  <p>P.C. board base P.C. board</p>  <p>When mounting a new board, check that the board is correctly set in the groove of base holder of P.C. board base.</p>
⑤	Rear cabinet	<p>1) Perform work of item 1 of ①, and ② ③.</p> <p>2) Remove fixed screws fixing to the bottom plate. (ST1T04 x 10l 3 pcs.)</p> <p>3) Remove fixed screws fixing to the heat exchanger. (ST1T04 x 10l 2 pcs.)</p> <p>4) Remove fixed screw fixing to the valve mounting plate. (ST1T04 x 10l 1 pc.)</p>	 <p>Reactor</p>

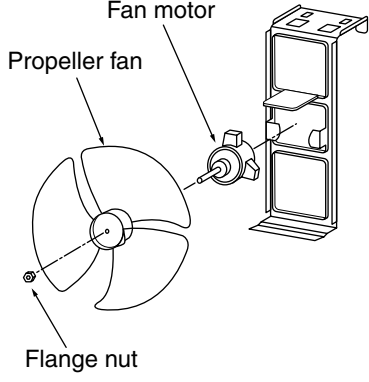
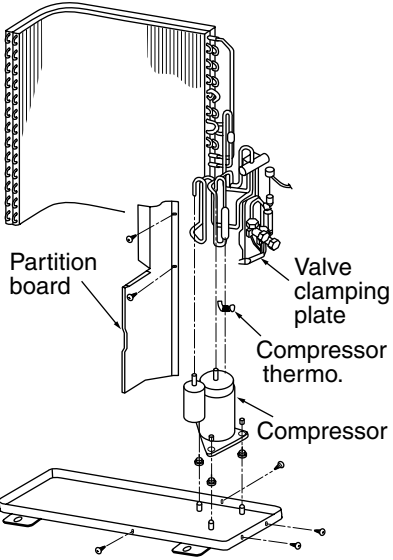
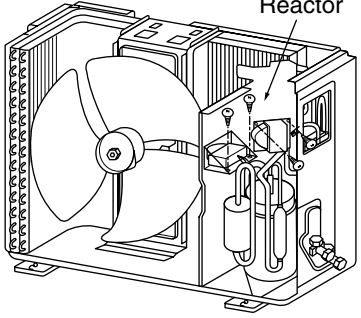
No.	Part name	Procedure	Remarks
⑥	Fan motor	<ol style="list-style-type: none"> 1) Perform work of item 1 of ① and ②. 2) Remove the flange nut fixing the fan motor and the propeller. <ul style="list-style-type: none"> • Flange nut is loosened by turning clockwise. (To tighten the flange nut, turn counterclockwise.) 3) Remove the propeller fan. 4) Disconnect the connector for fan motor from the inverter. 5) Remove the fixing screws (3 pcs.) holding by hands so that the fan motor does not fall. 	 <p>The diagram shows a propeller fan attached to a fan motor. A flange nut is shown being loosened from the motor shaft. The fan motor is mounted on a vertical panel.</p>
⑦	Compressor	<ol style="list-style-type: none"> 1) Perform work of item 1 of ① and ②, ③, ④, ⑤. 2) Extract refrigerant gas. 3) Remove the partition board. (ST1TØ4 x 10ℓ 2 pcs.) 4) Remove the sound-insulation material. 5) Remove terminal cover of the compressor, and disconnect lead wire of the compressor thermo. and the compressor from the terminal. 6) Remove pipe connected to the compressor with a burner. 7) Remove the fixing screw of the bottom plate and heat exchanger. (ST1TØ4 x 10ℓ 1 pc.) 8) Remove the fixing screw of the bottom plate and valve clamping plate. (ST1TØ4 x 10ℓ 2 pcs.) 9) Pull upward the refrigeration cycle. 10) Remove nut fixing the compressor to the bottom plate. 	 <p>The diagram shows the internal components of the compressor area, including a partition board, a valve clamping plate, a compressor thermo. sensor, and the compressor itself mounted on a bottom plate.</p>
⑧	Reactor	<ol style="list-style-type: none"> 1) Perform work of item 1 of ①, and ③. 2) Remove lead wires clung in holder on the partition board. 3) Remove screws fixing the reactor. (ST1TØ4 x 10ℓ 2 pcs.) 	 <p>The diagram shows the reactor assembly, which includes a fan and various internal components, mounted on a base.</p>

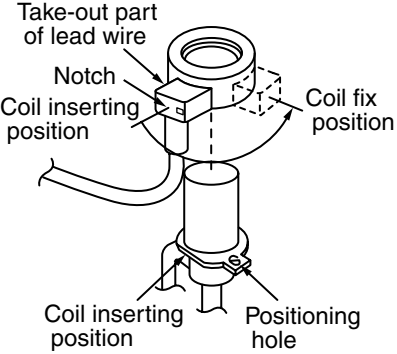
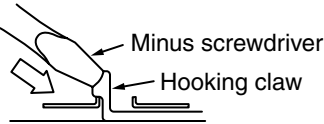
No.	Part name	Procedure	Remarks
⑨	Pulse modulating valve coil	<p>1. Detachment</p> <ol style="list-style-type: none"> 1) Perform work of item 1 of ①, and ②, ③, ⑤. 2) Turn the coil clockwise (counterclockwise) by 90 degrees, and remove coil from the pulse modulating valve. <p>2. Attachment</p> <ol style="list-style-type: none"> 1) Set take-out part of the lead wire of coil to the coil inserting position of the pulse modulating valve, and attach the coil. 2) Turn the coil by 90 degrees, set surely the concave part at lower part of the coil to the positioning hole of the pulse modulating valve, and then fix the coil. <div data-bbox="469 667 1024 879" style="border: 1px solid black; padding: 5px; margin-top: 10px;"> <p>The pulse modulating valve has A room side and B room side. After mounting it, check that coil at B room side (Red marking is marked on the pulse modulating valve.) is connected to CN13 of the control board assembly.</p> </div>	 <p>The diagram shows a pulse modulating valve with a coil being attached. Labels include: 'Take-out part of lead wire' pointing to the wire extending from the coil; 'Notch' pointing to a cutout on the valve; 'Coil inserting position' pointing to the area where the coil is being inserted; 'Coil fix position' pointing to the top of the valve; 'Coil inserting position' pointing to the bottom of the valve; and 'Positioning hole' pointing to a hole on the side of the valve.</p>
⑩	Fan guard	<p>1. Detachment</p> <ol style="list-style-type: none"> 1) Perform work of item 1 of ①, and ②. 2) Remove the front cabinet, and put it down so that fan guard side directs downward. <div data-bbox="469 1066 1024 1146" style="border: 1px solid black; padding: 5px; margin-top: 10px;"> <p>Perform work on a corrugated cardboard, cloth, etc. to prevent flaw to the product.</p> </div> <ol style="list-style-type: none"> 3) Remove the hooking claws by pushing minus screwdriver according to the arrow mark in the right figure, and remove the fan guard. <p>2. Attachment</p> <ol style="list-style-type: none"> 1) Insert claw of the fan guard in the hole of the front cabinet. Push the hooking claws (10 positions) by hands and fix the claws. <div data-bbox="469 1430 1024 1549" style="border: 1px solid black; padding: 5px; margin-top: 10px;"> <p>All the attaching works have completed. Check that all the hooking claws are fixed to the specified positions.</p> </div>	 <p>The diagram shows a hand using a minus screwdriver to push a hooking claw. Labels include: 'Minus screwdriver' pointing to the tool and 'Hooking claw' pointing to the part being pushed.</p>

No.	Part name	Procedure	Remarks																												
⑪	<p>Replacement of temperature sensor for servicing only</p> <p>Common service parts of sensor TO, TS, TE, TD</p> <p>These are parts for servicing sensors.</p> <p>Please check that the accessories shown in the right table are packed.</p>	<ol style="list-style-type: none"> 1) Cut the sensor 100 mm longer than old one. 2) Cut the protective tube after pulling out it (200 mm). 3) Move the protective tube toward the thermal sensor side and tear the tip of lead wire in two then strip the covering part. 4) Pass the stripped part through the thermal constringent tube. 5) Cut the old sensor 100 mm length on the connector side, and recycle that connector. 6) Tear the lead wire in two on the connector side and strip the covering part. 7) Twist the leads on the connector and sensor sides, and solder them. 8) Move the thermal constringent tubes toward the soldered parts and heat them with the dryer and constring them. 9) Wind the attached color tape round the both terminals of the protective tube when colored protective tube is used. 10) Fix the sensor again. <p>NOTES :</p> <ol style="list-style-type: none"> 1) Store the joint part of the sensor and the connector in the electric parts box. 2) Never joint them near the thermal sensor part. Otherwise it would cause insulation inferiority because of dew drops. 3) When replacing the sensor using the colored protective tube, wind the color tape matching the color of that tube. 																													
		<table border="1"> <thead> <tr> <th></th> <th>Parts name</th> <th>Q'ty</th> <th>Remarks</th> </tr> </thead> <tbody> <tr> <td>1</td> <td>Sensor</td> <td>1</td> <td>Length : 3m</td> </tr> <tr> <td>2</td> <td>Sensor Spring (A)</td> <td>1</td> <td>For spare</td> </tr> <tr> <td>3</td> <td>Sensor Spring (B)</td> <td>1</td> <td>For spare</td> </tr> <tr> <td>4</td> <td>Thermal constringent tube</td> <td>3</td> <td>Including one spare</td> </tr> <tr> <td>5</td> <td>Color tape</td> <td>1</td> <td>9 colors</td> </tr> <tr> <td>6</td> <td>Terminal</td> <td>3</td> <td></td> </tr> </tbody> </table>		Parts name	Q'ty	Remarks	1	Sensor	1	Length : 3m	2	Sensor Spring (A)	1	For spare	3	Sensor Spring (B)	1	For spare	4	Thermal constringent tube	3	Including one spare	5	Color tape	1	9 colors	6	Terminal	3		
	Parts name	Q'ty	Remarks																												
1	Sensor	1	Length : 3m																												
2	Sensor Spring (A)	1	For spare																												
3	Sensor Spring (B)	1	For spare																												
4	Thermal constringent tube	3	Including one spare																												
5	Color tape	1	9 colors																												
6	Terminal	3																													

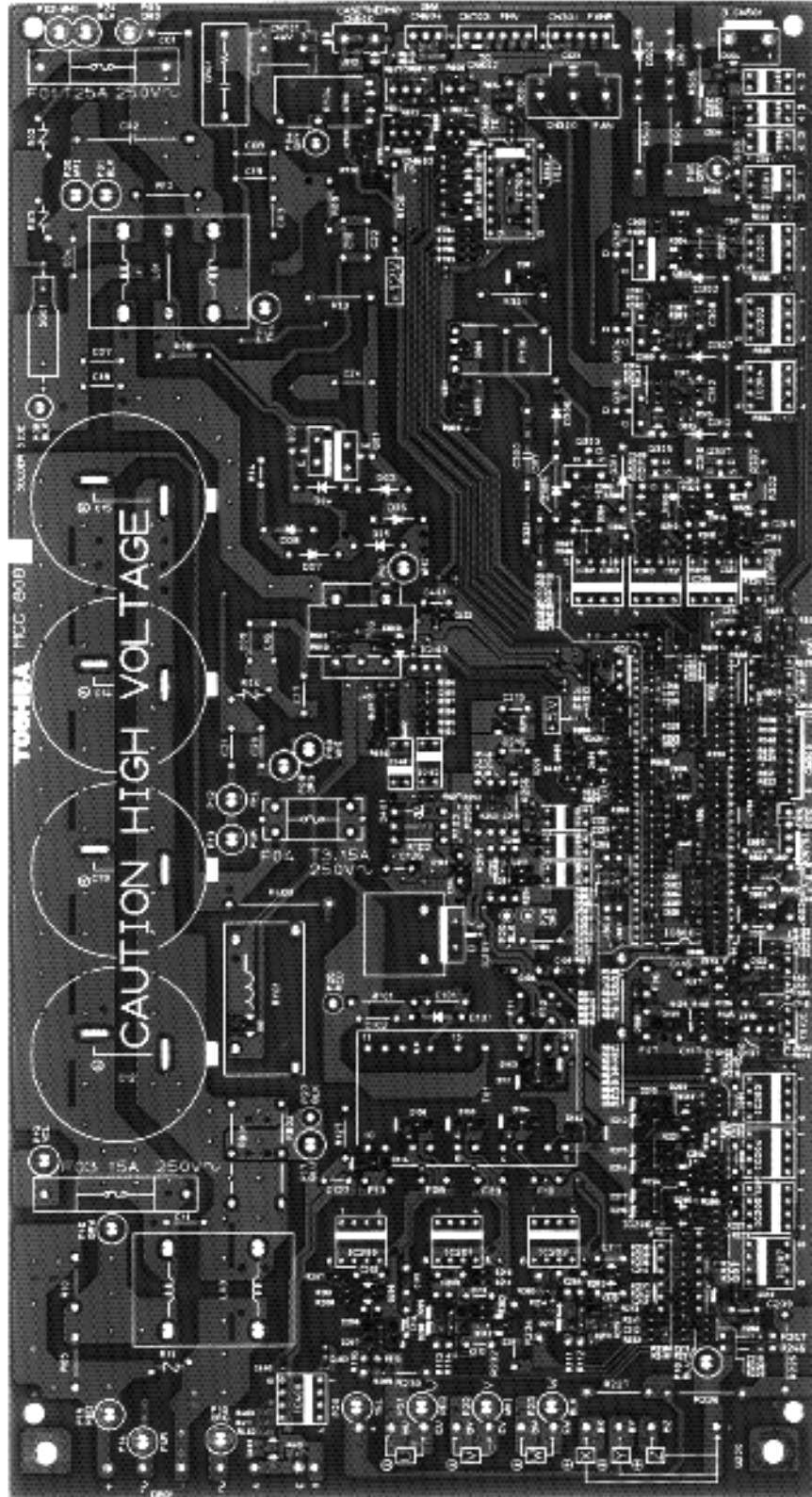

12. EXPLODED VIEWS AND PARTS LIST

12-1. Indoor Unit (1)

RAS-10YKV-E, RAS-13YKV-E

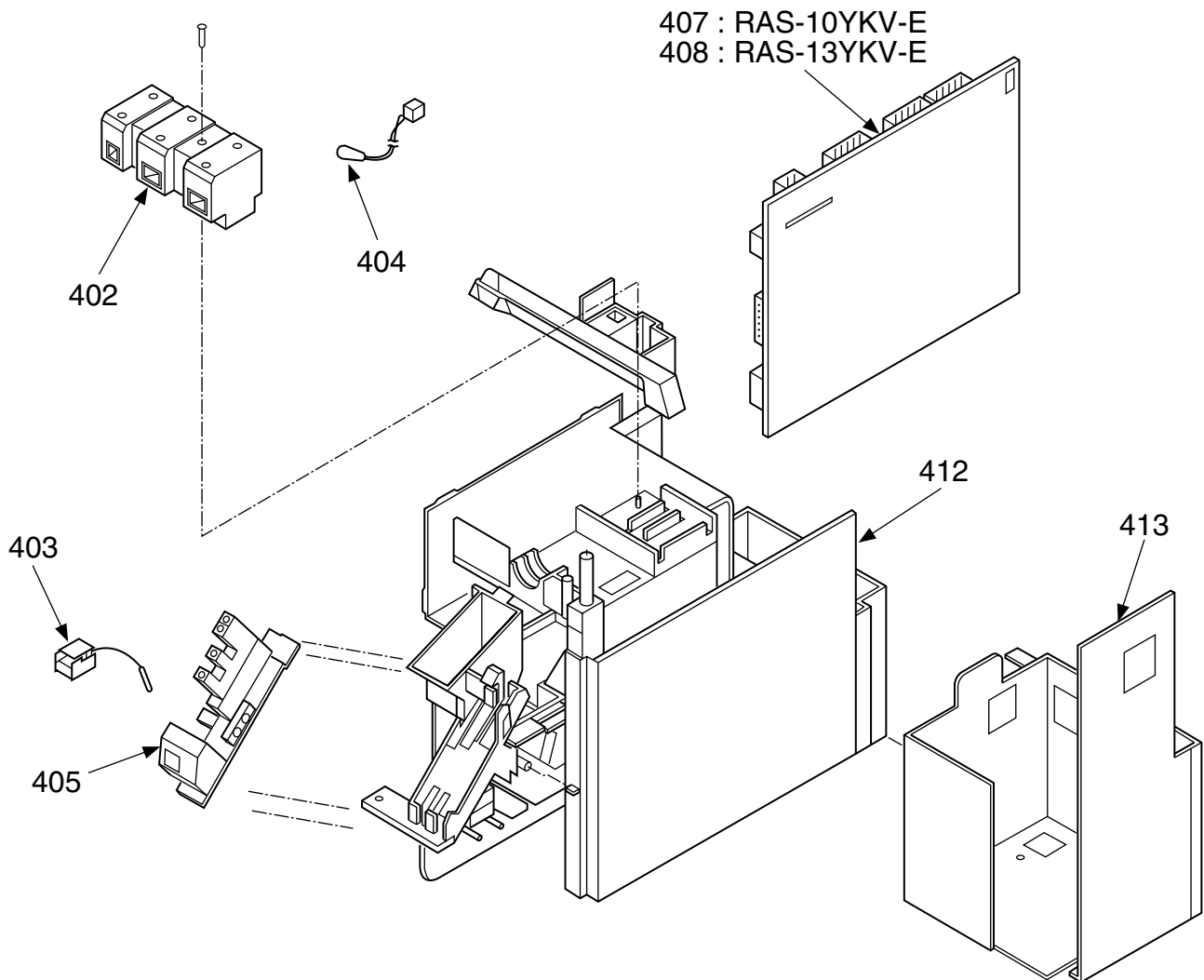

Location No.	Part No.	Description
402	43T60002	Terminal Block, 3P, AC 300V, 20A
403	43T69004	Sensor, Heat Exchanger 10kΩ, 25°C
404	43T69005	Sensor, Thermostat 10kΩ, 25°C
405	43T69031	P.C. Board, Assembly, WRS-LED, MCC-766

Location No.	Part No.	Description
407	43T69062	P.C. Board Assembly, MCC-772 (10YKV-E)
408	43T69063	P.C. Board Assembly, MCC-772 (13YKV-E)
412	43T61001	Base, E-Parts, ABS, Black UL94-5V
413	43T62006	Base, Shield SGCC-Z08-LUB

Indoor Unit (2)

RAS-10YKV-E, RAS-13YKV-E

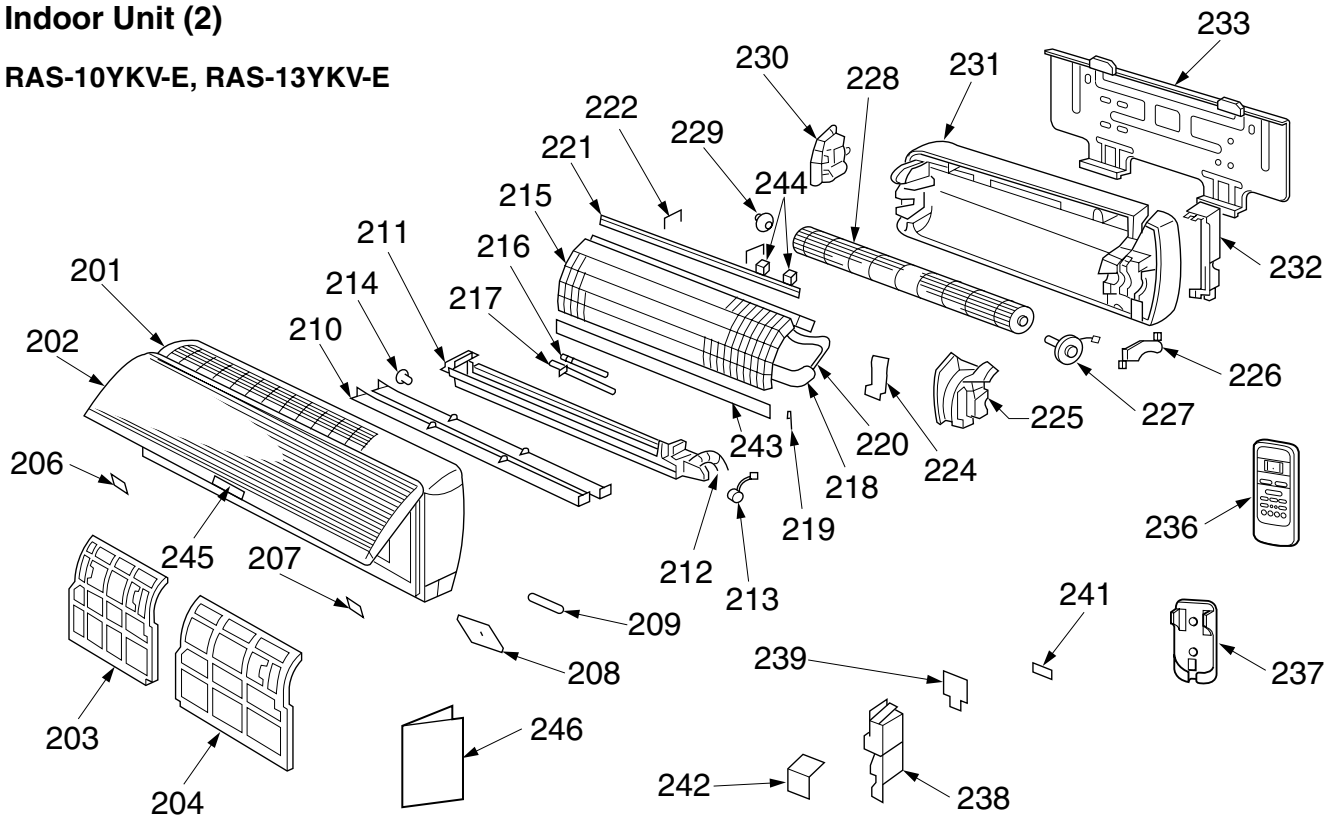

Location No.	Part No.	Description
201	43T00043	Front Panel Assembly
202	43T00044	Grille, Suction
203	43T80001	Air Filter (L)
204	43T80002	Air Filter (R)
206	43T07021	Screw Cap (L)
207	43T07020	Screw Cap (R)
208	43T08106	LED Panel (10YKV-E)
208	43T08107	LED Panel (13YKV-E)
209	43T19004	Accepted Signal Filter
210	43T09035	Horizontal Louver Assembly for Service
211	43T09004	Louver Assembly
212	43T70001	Drain Hose Assembly
213	43T21003	Motor, Stepping
214	43T07001	Bushing
215	43T44024	Refrigerant Cycle Assembly
216	43T47006	Pipe, Delivery
217	43T47005	Pipe, Suction
218	43T49007	Pipe, Shield
219	43T19003	Holder, Sensor
220	43T49003	Spring
221	43T49028	Plate, EVA-SEAL

Location No.	Part No.	Description
222	43T49023	Holder of Plate of EVA-SEAL
224	43T79002	Drain Guide
225	43T39002	Motor Band (Left)
226	43T39001	Motor Band (Right)
227	43T21010	Fan Motor
228	43T20007	Fan, Cross Flow
229	43T22002	Bearing
230	43T39003	Base, Bearing
231	43T03001	Rear Plate
232	43T07002	Pipe Holder
233	43T82001	Installation Plate
236	43T69044	Remote Controller
237	43T63002	Holder, Remote Controller
238	43T62020	Cover, E-Parts
239	43T62002	Cover, Up, Terminal
241	43T62003	Cord Clamp
242	43T62004	Shield Cover
243	43T39010	Drain Guide (UP)
244	43T49024	U Pipe Holder
245	43T01002	Mark
246	43T85061	Manual

12-2. Outdoor Unit

RAS-10YAV-E, RAS-13YAV-E

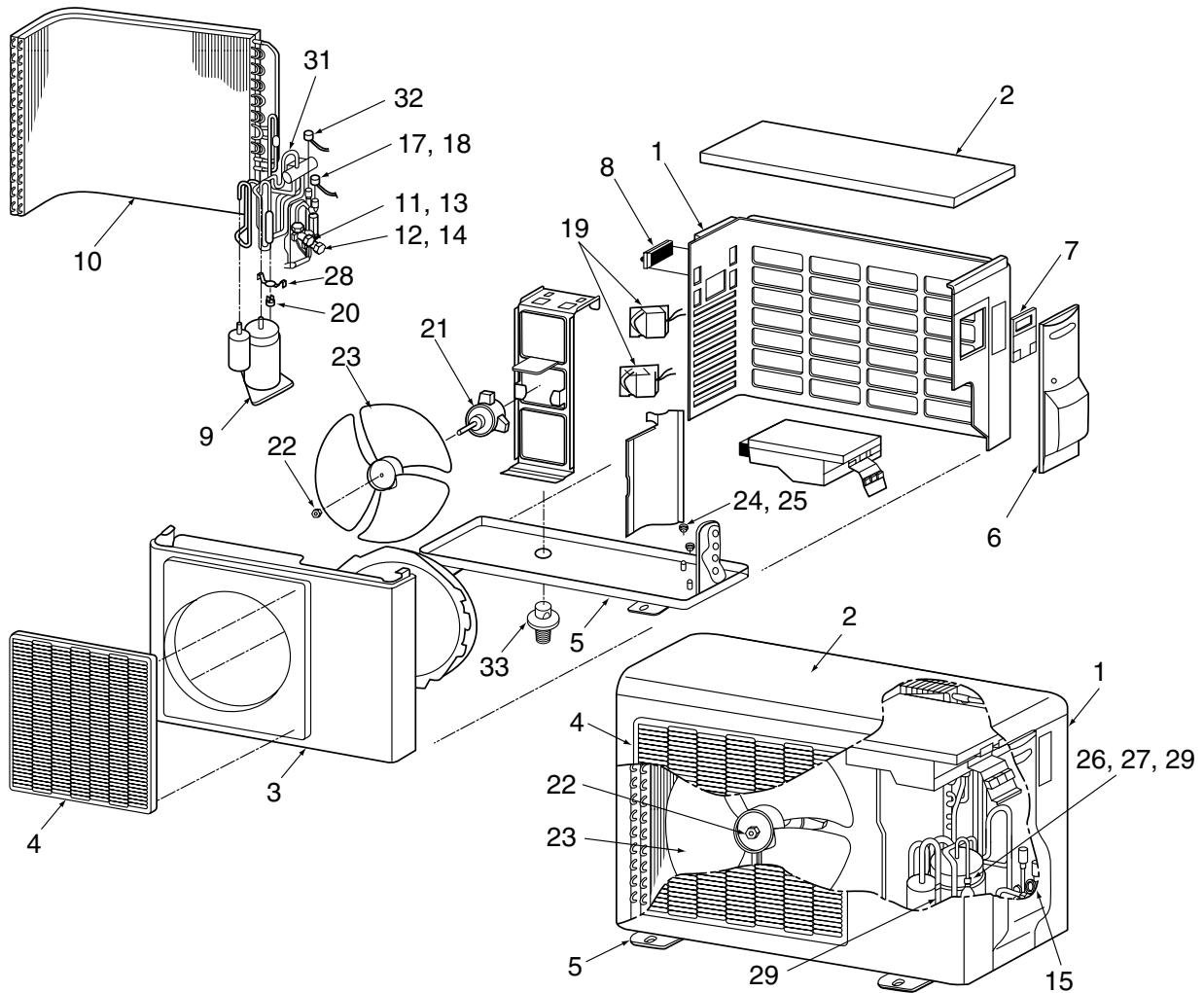

Location No.	Part No.	Description
01	43005368	Cabinet, Back, Assembly
02	43005369	Cabinet, Upper, Assembly
03	43005401	Cabinet, Front, Assembly
04	4301V030	Guard, Fan
05	43042461	Base, Assembly
06	4301V012	Cover, Valve, Packed
07	43062230	Cover, Wiring, Assembly
08	43019903	Hanger
09	43041607	Compressor
10	43043644	Condenser, Assembly
11	43046382	Valve, Packed, 6,35
12	43046383	Valve, Packed, 9,52
13	43147196	Bonnet, 1/4 IN
14	43047401	Bonnet, 3/8 IN
15	43047491	Tube, Capillary, I.D.1,5
17	43046351	Valve, Pulse Modulating

Location No.	Part No.	Description
18	43046378	Coil, P.M.V.
19	43058264	Reactor
20	43050298	Thermo. Bimetal, CS-7
21	4302C019	Motor, Fan, DC
22	43047549	Nut, Flange
23	43020310	Fan, Propeller
24	43097204	Nut
25	43049643	Cushion, Rubber
26	43063274	Holder, Sensor
27	43063198	Holder, Sensor
28	43063195	Holder, Thermo. Bimetal
29	43019904	Holder, Sensor
31	43046344	Valve, 4-way
32	43046348	Solenoid Coil
33	43032441	Drain Nipple

12-3. P.C. Board Layout
RAS-10YAV-E, RAS-13YAV-E

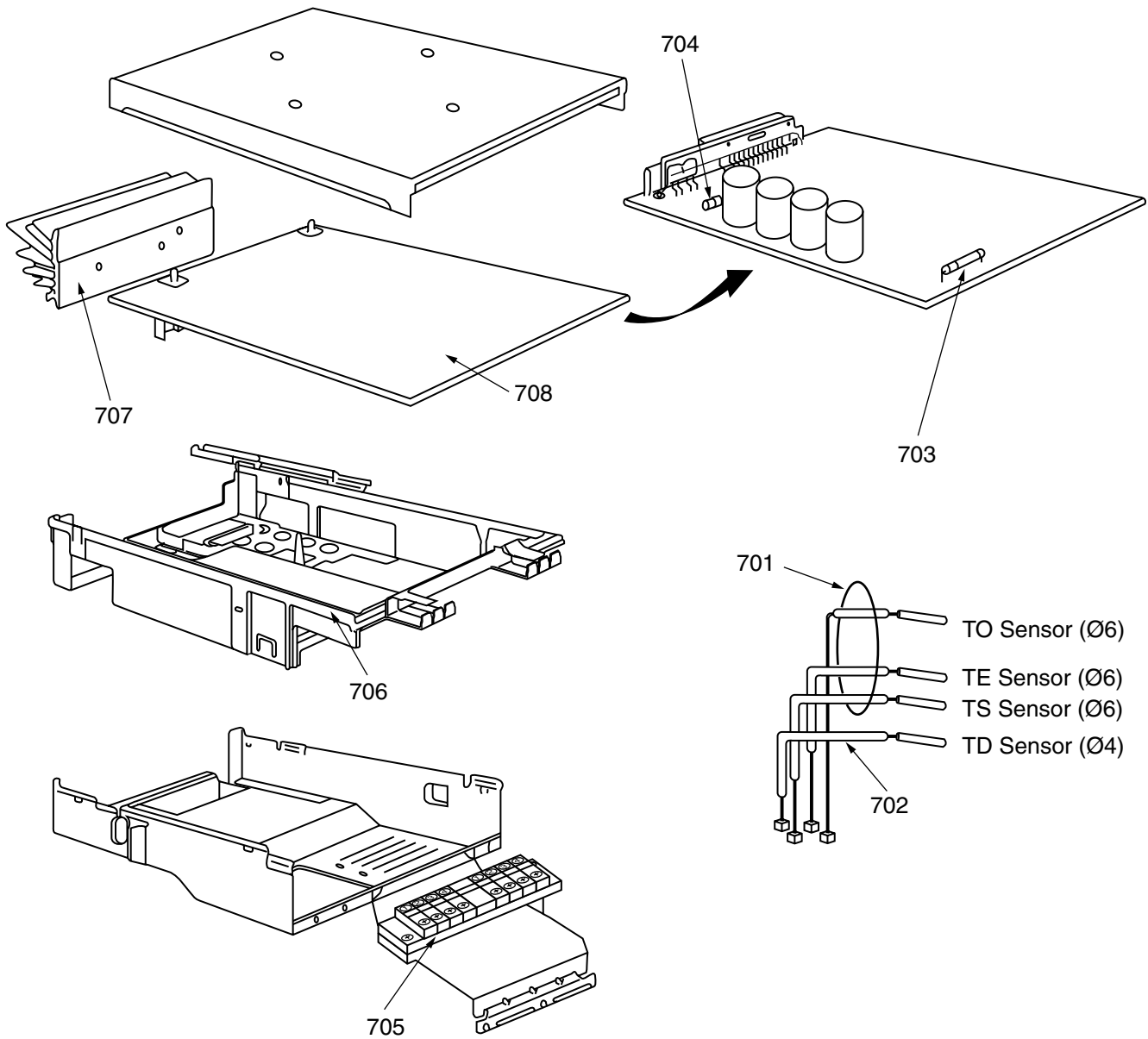

Location No.	Part No.	Description
701	43050382	Sensor, TC (F6)
702	43050334	Sensor, TD (F4)
703	43060052	Fuse, 25A, 250V, Lead Type
704	43060726	Fuse, 15A, 250V, Lead Type

Location No.	Part No.	Description
705	4306A044	Terminal block, 9P
706	43062215	Base, P.C. Board
707	43063306	Heatsink
708	4306S230	P.C. Board Assembly, MCC-808

TOSHIBA CARRIER CORPORATION
336 TADEHARA FUJI-SHI, SHIZUOKA-KEN, 416-8521, JAPAN

