

Heater Unit

HU-740/640/540

User's Manual

Thank you very much for purchasing this product.

- To ensure correct and safe usage with a full understanding of this product's performance, please be sure to read through this manual completely and store it in a safe location.
- Unauthorized copying or transferral of this manual, in whole or in part, is prohibited.
- The contents of this operation manual and the specifications of this product are subject to change without notice.
- The operation manual and the product have been prepared and tested as much as possible. If you find any misprint or error, please inform us.
- Roland DG Corp. assumes no responsibility for any direct or indirect loss or damage which may occur through use of this product, regardless of any failure to perform on the part of this product.
- Roland DG Corp. assumes no responsibility for any direct or indirect loss or damage which may occur with respect to any article made using this product.

For the USA

**FEDERAL COMMUNICATIONS COMMISSION
RADIO FREQUENCY INTERFERENCE
STATEMENT**

This equipment has been tested and found to comply with the limits for a Class A digital device, pursuant to Part 15 of the FCC Rules.

These limits are designed to provide reasonable protection against harmful interference when the equipment is operated in a commercial environment.

This equipment generates, uses, and can radiate radio frequency energy and, if not installed and used in accordance with the instruction manual, may cause harmful interference to radio communications.

Operation of this equipment in a residential area is likely to cause harmful interference in which case the user will be required to correct the interference at his own expense.

Unauthorized changes or modification to this system can void the users authority to operate this equipment.

NOTICE

Grounding Instructions

Do not modify the plug provided - if it will not fit the outlet, have the proper outlet installed by a qualified electrician.

Check with qualified electrician or service personnel if the grounding instructions are not completely understood, or if in doubt as to whether the tool is properly grounded.

Use only 3-wire extension cords that have 3-prong grounding plugs and 3-pole receptacles that accept the tool's plug.

Repair or replace damaged or worn out cord immediately.

For Canada

CLASS A NOTICE

This Class A digital apparatus meets all requirements of the Canadian Interference-Causing Equipment Regulations.

CLASSE A AVIS

Cet appareil numérique de la classe A respecte toutes les exigences du Règlement sur le matériel brouilleur du Canada.



ROLAND DG CORPORATION

1-6-4 Shinmiyakoda, Hamamatsu-shi, Shizuoka-ken, JAPAN 431-2103

MODEL NAME : See the MODEL given on the rating plate.

RELEVANT DIRECTIVE : EC LOW VOLTAGE DIRECTIVE (73/23/EEC)

EC ELECTROMAGNETIC COMPATIBILITY DIRECTIVE (89/336/EEC)

WARNING

This is a Class A product. In a domestic environment this product may cause radio interference in which case the user may be required to take adequate measures.



Contents	1
To Ensure Safe Use	2
About the Labels Affixed to the Unit	4
Pour utiliser en toute sécurité	5
À propos des étiquettes collées sur l'appareil	8
1. Getting Started	9
1-1 What's the HU-740/640/540?	10
Features	10
Installable Combinations	10
Recommended Ink	10
1-2 Installation and Transport	11
Installing the Heater Unit on the Printer	11
About the Power Supply	11
When Moving the Printer	11
1-3 Part Names	12
2. Using the Heater Unit	15
2-1 Switching the Power On and Off	16
Switching On the Controller	16
Switching Off the Controller	16
2-2 Loading Media	17
About the Ambient Temperature During Heater Use	17
Points to Observe When Loading Media	17
2-3 Printing and Cutting	18
Printing	18
Cutting/Printing and Cutting	19
2-4 What to Do If	20
3. Other Information	21
3-1 Daily Maintenance	23
3-2 Additional Menus on the Printer	23
3-3 Specifications	24
Heater Unit Specifications	24
Printer Specifications When the Heater Unit Is Installed	24

SOLJET™ and ECO-SOL INK™ are trademarks of Roland DG Corporation.



Other company names and product names are trademarks or registered trademarks of their respective holders.

To Ensure Safe Use

About ⚠ WARNING and ⚠ CAUTION Notices

 WARNING	Used for instructions intended to alert the user to the risk of death or severe injury should the unit be used improperly.
 CAUTION	Used for instructions intended to alert the user to the risk of injury or material damage should the unit be used improperly. * Material damage refers to damage or other adverse effects caused with respect to the home and all its furnishings, as well to domestic animals or pets.

About the Symbols

	The ⚠ symbol alerts the user to important instructions or warnings. The specific meaning of the symbol is determined by the design contained within the triangle. The symbol at left means "danger of electrocution."
	The ⚡ symbol alerts the user to items that must never be carried out (are forbidden). The specific thing that must not be done is indicated by the design contained within the circle. The symbol at left means the unit must never be disassembled.
	The ● symbol alerts the user to things that must be carried out. The specific thing that must be done is indicated by the design contained within the circle. The symbol at left means the power-cord plug must be unplugged from the outlet.

⚠ WARNING



Do not disassemble, repair, or modify.
 Doing so may lead to fire or abnormal operation resulting in injury.



Ground the unit with the ground wire.
 Failure to do so may result in risk of electrocution in the event of a mechanical problem.



Do not use with any electrical power supply that does not meet the ratings displayed on the unit.
 Use with any other power supply may lead to fire or electrocution.



Do not use while in an abnormal state (i.e., emitting smoke, burning odor, unusual noise, or the like).
 Doing so may result in fire or electrocution. Immediately switch off the power, unplug the power cord from the electrical outlet, and contact your authorized Roland DG Corp. dealer or service center.



Use only with the power cord included with this product.
 Use with other than the included power cord may lead to fire or electrocution.



Do not connect the power cord with other electrical loads on a single electrical outlet.
 Doing so may generate heat and cause fire.



Do not touch or pull out the power connectors under the bottom of the printer.
 Doing so may lead to fire, electrical shock, electrocution or malfunction.



Do not spill combustible liquid over the platen.
 Doing so may cause fire.



Do not place any potentially flammable object on the platen while the heater is in operation.
 Doing so may cause fire.

CAUTION



Do not use with a damaged power cord or plug, or with a loose electrical outlet.

Doing so may lead to fire, electrical shock, or electrocution.

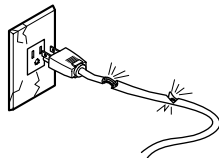

When not in use for extended periods, unplug the power-cord plug from the electrical outlet.

Failure to do so may result in danger of electrical shock, electrocution, or fire due to deterioration of electrical insulation.

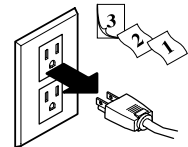

Do not damage or modify the electrical power cord, subject it to excessive bending, twisting, pulling, binding, or pinching, or place any object or weight on it.

Doing so may damage the electrical power cord, leading to fire, electrical shock, or electrocution.

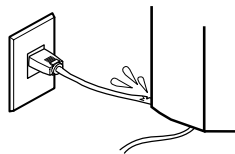

When unplugging the electrical power cord from the power outlet, grasp the plug, not the cord.

Unplugging by pulling the cord may damage it, leading to fire, electrical shock, or electrocution.

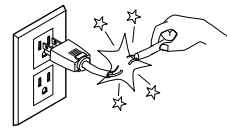

Do not attempt to unplug the power-cord plug with wet hands.

Doing so may result in electrical shock or electrocution.

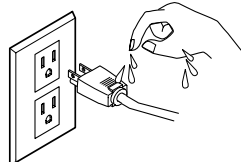

Do not allow liquids, metal objects or flammables inside the machine.

Such materials can cause fire.

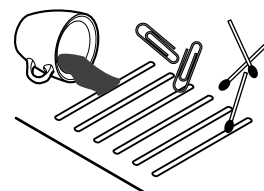

Do not touch the platen when the heater is operating.

Doing so may cause burns because the platen is hot.



Do not hang on to the hose. Do not hang anything on it.

Doing so may cause the unit to tip over, leading to injury.



When cleaning the heater unit, be sure to wait approximately 30 minutes or more after switching off the power of the heater and the sub power of the printer until the temperature of the platen falls sufficiently.

Doing so may cause burns because the platen is hot.



Be sure to use the media with a width of 500 mm (19-11/16 in.) or more.

Failure to do so may cause overheating of the heater, leading to fire.



Ensure adequate ventilation for the work area.

Failure to do so may result in odor, physical distress, or fire.



Do not press the [SEL] key of the controller.

Doing so may cause malfunction of the heater, leading to fire.

About the Labels Affixed to the Unit

These labels are affixed to the body of this product.

The following figures describe the location and content of these messages.

Controller

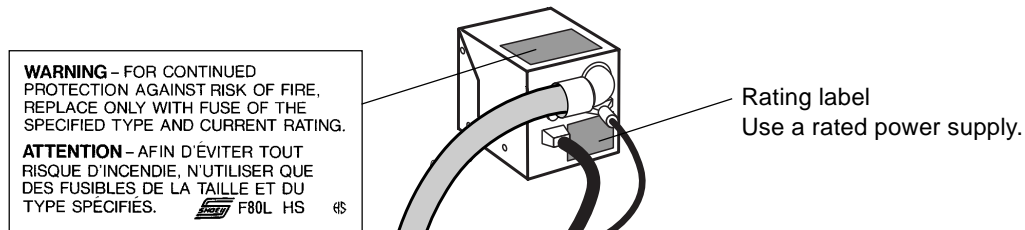

Inside the front cover

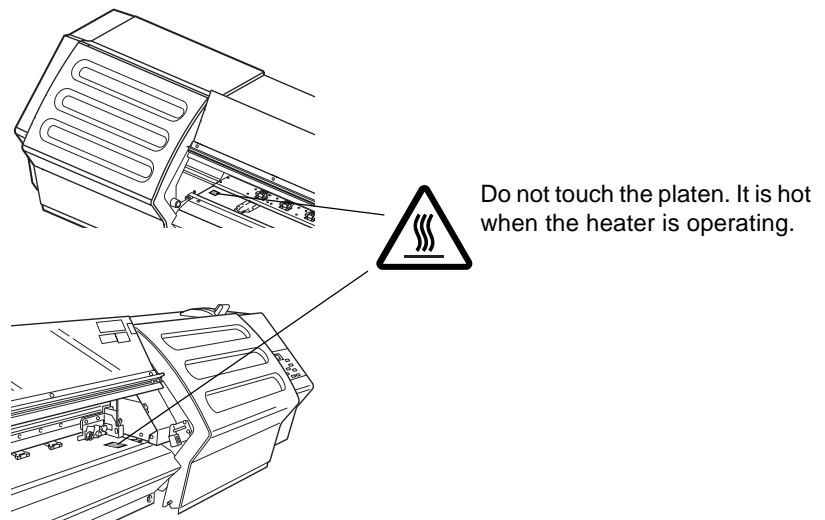



In addition to these symbols, the symbols shown below are also used.

 **Notice** : Indicates information to prevent machine breakdown or malfunction and ensure correct use.



 **Point** : Indicates a handy tip or advice regarding use.

Pour utiliser en toute sécurité

Avis sur les avertissements

 ATTENTION	Utilisé pour avertir l'utilisateur d'un risque de décès ou de blessure grave en cas de mauvaise utilisation de l'appareil.
 PRUDENCE	Utilisé pour avertir l'utilisateur d'un risque de blessure ou de dommage matériel en cas de mauvaise utilisation de l'appareil. * Par dommage matériel, il est entendu dommage ou tout autre effet indésirable sur la maison, tous les meubles et même les animaux domestiques.

À propos des symboles

	Le symbole \triangle attire l'attention de l'utilisateur sur les instructions importantes ou les avertissements. Le sens précis du symbole est déterminé par le dessin à l'intérieur du triangle. Le symbole à gauche signifie "danger d'électrocution".
	Le symbole \otimes avertit l'utilisateur de ce qu'il ne doit pas faire, ce qui est interdit. La chose spécifique à ne pas faire est indiquée par le dessin à l'intérieur du cercle. Le symbole à gauche signifie que l'appareil ne doit jamais être démonté.
	Le symbole \bullet prévient l'utilisateur sur ce qu'il doit faire. La chose spécifique à faire est indiquée par le dessin à l'intérieur du cercle. Le symbole à gauche signifie que le fil électrique doit être débranché de la prise.

ATTENTION



Ne pas démonter, réparer ni modifier.

Démonter, réparer ou modifier l'appareil risque de provoquer un incendie ou de causer un fonctionnement anormal entraînant des blessures.



Mettre l'appareil à la terre avec le fil de mise à la terre.

Ne pas respecter cette consigne peut créer un risque d'électrocution en cas de panne mécanique.



Ne pas utiliser avec une source d'alimentation électrique non conforme à la norme indiquée sur l'appareil.

Utiliser l'appareil avec une autre source d'alimentation risque de provoquer un incendie ou de causer une électrocution.



Ne pas utiliser l'appareil s'il est dans un état anormal (p.ex., émission de fumée, odeur de brûlé, bruit inhabituel ou autre anomalie).

Ne pas respecter cette consigne risque de provoquer un incendie ou une électrocution. Couper immédiatement l'alimentation électrique, débrancher le fil de la prise et communiquer avec le revendeur ou le centre de service autorisés de la société Roland DG.



Utiliser l'appareil uniquement avec le fil électrique fourni.

Utiliser l'appareil avec un autre fil risque de provoquer un incendie ou une électrocution.



Ne pas brancher d'autres appareils dans la même prise que l'appareil.

Ne pas respecter cette consigne risque de causer une surchauffe et de provoquer un incendie.



Ne pas toucher ni sortir les connecteurs d'alimentation sous l'imprimante.

Ceci peut causer un incendie, un choc électrique, une électrocution ou une panne.

ATTENTION

-  **Ne jamais poser d'objets potentiellement inflammables sur la plaque d'exposition lorsque le chauffage fonctionne.**

Cela crée un risque d'incendie.

-  **Ne pas répandre de liquide combustible sur la plaque d'exposition.**

Cela crée un risque d'incendie.

PRUDENCE

-  **Ne pas utiliser si le fil ou la fiche électriques sont endommagés; ne pas brancher dans une prise mal fixée.**

Négliger de suivre cette consigne risque de provoquer un incendie ou de causer une décharge électrique ou une électrocution.

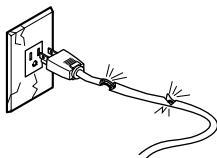

-  **Si l'appareil reste inutilisé pendant de longues périodes, débrancher la fiche de la prise.**

Négliger de suivre cette consigne peut créer un risque de décharge électrique ou d'électrocution ou provoquer un incendie à cause de la détérioration de l'isolant électrique.

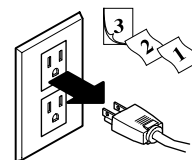

-  **Ne pas endommager ni modifier le fil électrique. Ne pas le plier, le tordre, l'étirer, l'attacher ou le serrer de façon excessive. Ne pas placer d'objet ou de poids sur le fil.**

Négliger de suivre cette consigne peut endommager le fil électrique, ce qui risque de provoquer un incendie ou de causer une décharge électrique ou une électrocution.

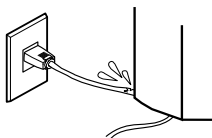

-  **Pour débrancher l'appareil, saisir la fiche et non le fil électrique.**

Tirer sur le fil peut l'endommager, ce qui risque de provoquer un incendie ou de causer une décharge électrique ou une électrocution.

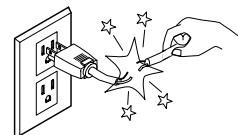

-  **Ne pas débrancher le fil avec des mains mouillées.**

Ne pas respecter cette consigne risque de provoquer des décharges électriques ou une électrocution.

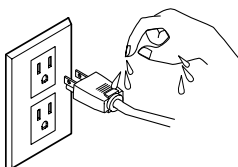

-  **Ne pas laisser de liquides ni d'objets métalliques ou inflammables s'infiltrer dans l'appareil.**

De telles infiltrations peuvent provoquer un incendie.

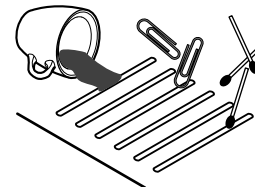

-  **Ne pas toucher la plaque d'exposition lorsque le chauffage fonctionne.**

La plaque étant très chaude, il est possible de se brûler.

-  **Ne pas tirer sur le flexible et ne rien suspendre sur le flexible.**

L'appareil pourrait se renverser et causer des blessures.

PRUDENCE



Avant de nettoyer le bloc de chauffage, attendre au moins 30 minutes après l'extinction du chauffage et de l'alimentation secondaire de l'imprimante pour que la température de la plaque d'exposition soit suffisamment basse.

La plaque étant très chaude, il est possible de se brûler.



S'assurer que le lieu de travail est bien aéré.

Sinon, des odeurs fortes peuvent se dégager et il y a risque de malaises physiques ou d'incendie.



Toujours utiliser un support d'au moins 500 mm.

Le chauffage risque sinon de trop chauffer, ce qui peut entraîner un incendie.





Ne pas appuyer sur la touche [SEL] de la commande.

Ceci peut causer une panne de chauffage et entraîner un incendie.

À propos des étiquettes collées sur l'appareil

Ces étiquettes sont collées à l'extérieur de l'appareil.
Les dessins suivants indiquent l'endroit et le contenu des messages.

Commande

WARNING - FOR CONTINUED PROTECTION AGAINST RISK OF FIRE, REPLACE ONLY WITH FUSE OF THE SPECIFIED TYPE AND CURRENT RATING.
ATTENTION - AFIN D'ÉVITER TOUT RISQUE D'INCENDIE, N'UTILISER QUE DES FUSIBLES DE LA TAILLE ET DU TYPE SPÉCIFIÉS.  F80L HS 

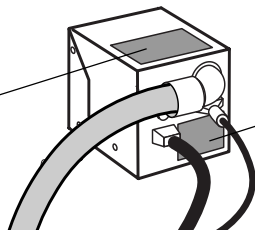

Étiquette des caractéristiques électriques
Utiliser l'alimentation appropriée

Intérieur de le couvercle de l'imprimante

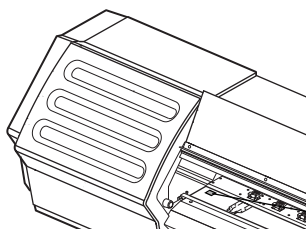

Ne pas toucher la plaque d'exposition lorsque le chauffage fonctionne.
La plaque étant très chaude.

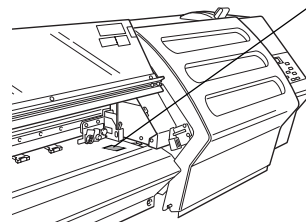

1. Getting Started

This section describes the features, part names, and the like of the HU-740/640/540.

1-1 What's the HU-740/640/540?

Features

The HU-740/640/540 is a heater unit for Roland DG SOLJET ProII series large-format printers. It enhances the fixation of the ink on the media and dries ink faster by preheating the media before printing. The controller for the HU-740/640/540 allows you to adjust the heater temperature to match the media.

Installable Combinations

The HU-740/640/540 can be installed on the following printers.

HU-740 ... SJ-740
HU-640 ... SJ-640
HU-540 ... SJ-540/SC-540

In this manual, the HU-740/640/540 is referred to as the "heater unit," and each model of the printer is referred to as the "printer."

Recommended Ink



Notice

Use ECO-SOL INK to ensure acceptable printing results when performing printing while using the heater unit. Using inks other than ECO-SOL INK may cause unexpected printing results.

1-2 Installation and Transport

Installing the Heater Unit on the Printer

The heater unit is to be installed on the printer by an authorized service engineer.

Notice

Never attempt to install the heater unit on the printer by yourself.

About the Power Supply

Be sure to use an electrical outlet for the power supply. Also, do not connect multiple electrical loads on a single electrical outlet.

Low or unstable voltage may result in inadequate heater performance. If the temperature of the heater fails to rise adequately even when used correctly, check the voltage of the power supply.

When Moving the Printer

Cables for the heater unit are located under the bottom of the printer. When removing the printer from the stand in order to move the printer to a different location, take care not to damage these cables. Otherwise fire, electric shock, or other serious damage may occur. In addition, the printer that the heater unit has been installed on cannot be repacked. In the event of damage to the cables or when repacking the printer, please contact your authorized Roland DG Corp. dealer or service center.

1-3 Part Names

Front View

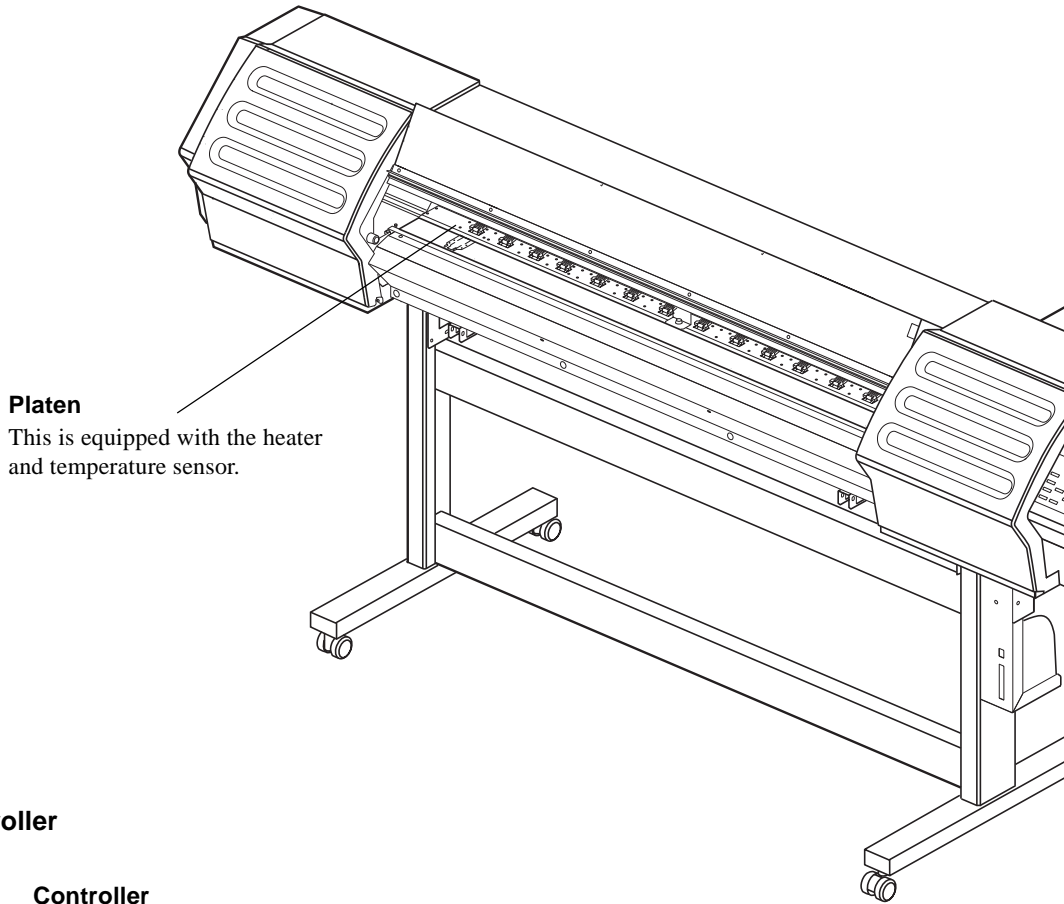

Controller

Controller

This is equipped with the heater and temperature sensor.

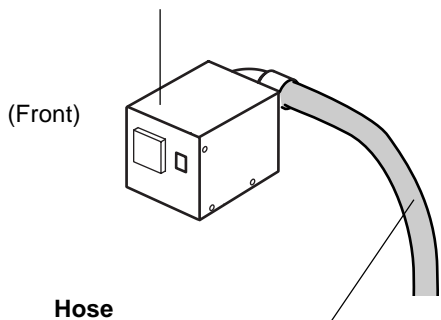

Hose

The power cord and other cables are inside the hose.

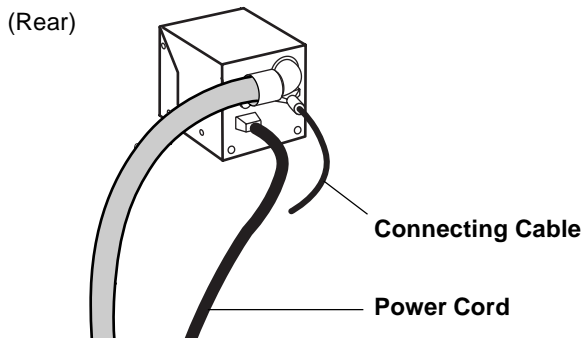

Do not hang on to the hose. Do not hang anything on it. Doing so may cause the unit to tip over, leading to injury.



Notice

Never disconnect the connecting cable. Doing so will cause the heater to fail to operate.

Control Panel

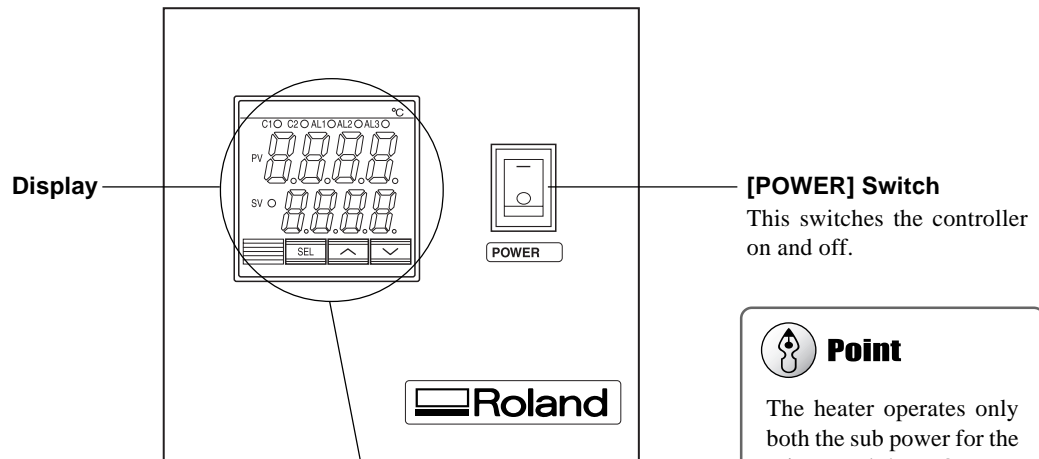

Point

The heater operates only both the sub power for the printer and the [POWER] switch are switched on.

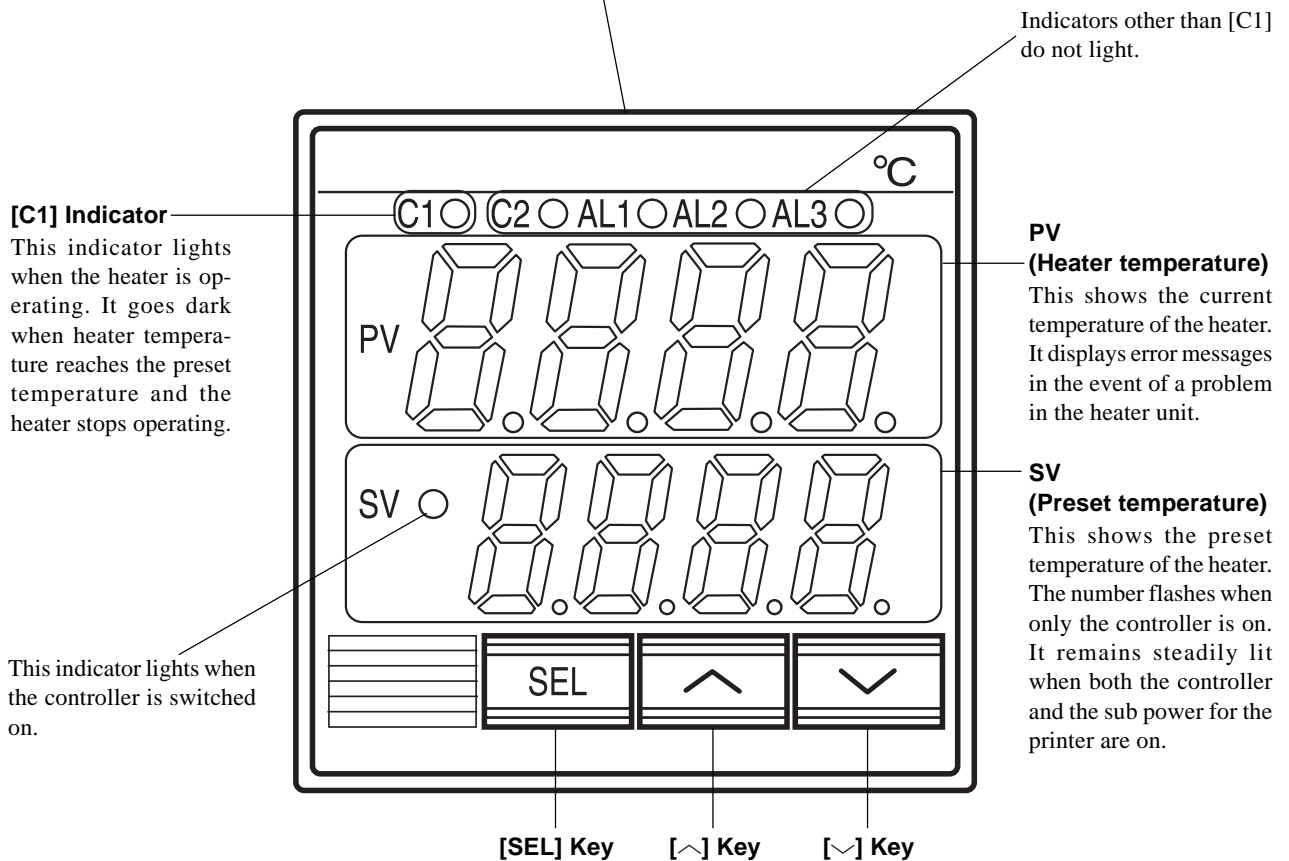

Do not press the [SEL] key. Doing so may cause malfunction of the heater, leading to fire or electrical shock.

2. Using the Heater Unit

This section describes how to print and cut while using the heater unit and the like.

2-1 Switching the Power On and Off



When not in use for extended periods, unplug the power-cord plug from the electrical outlet.

Switching On the Controller

- 1 Switch on the [POWER] switch on the controller.
After the display flashes for a short time, both [SV] and [PV] light up and indicate their values. If only [SV] flashes, go to step 2.

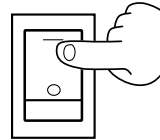

- 2 Switch on the sub power for the printer.
[SV] lights up and the heater is ready to operate.

- 3 The [C1] indicator on the display lights up.
The heater starts operating.



Notice

When the display shows characters other than numerical figures, such as UUUU or LLLL, immediately switch off the controller and contact your authorized Roland DG Corp. dealer or service center.



Point

Power Source for the Heater

The heater is connected to the sub power for the printer.

The heater operates only when both the controller and the sub power for printer are switched on.

Switching Off the Controller

Switch off the [POWER] switch on the controller.

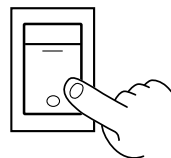

Notice

Switch off the controller when not using the heater.



Point

The preset temperature of the heater is saved in memory when the controller is switched off.

2-2 Loading Media

About the Ambient Temperature During Heater Use

To ensure stable printing quality, we recommend use in an environment where the ambient temperature is 20°C (68°F) or higher.

At low temperatures, warm-up may take a long time, or the temperature may fail to reach the preset value, or large differences in temperature may occur. Inadequate temperature may result in coarse printing.

If the media fails to warm up sufficiently, try setting the heater to a higher temperature. If this fails to resolve the problem, raise the temperature of the room.

Points to Observe When Loading Media

Check and observe the following points when loading media. For detailed information on how to load media, refer to the user's manual for the printer.

■ Use Media With a Width of about 1 m (40 in.) or More

We recommend using media having a width of about 1 m (40 in.) or more. Media of narrower width may take a long time to heat, or may fail to reach the preset temperature.

Also, in no event should media having a width of 50 cm (19-11/16 in.) or less be used. Doing so may lead to danger of overheating.

■ Before Loading Media, Allow the Heater to Cool Down to 30°C (86°F) or Lower

Before loading media, switch off the controller or set the preset temperature to 30°C and allow the heater to cool down. Loading media when the heater is 30°C (86°F) or more may cause the media to wrinkle or warp due to the sudden rise in temperature.

■ When Printing, Use the Media Clamps

Set the height of the printing heads to either "Middle" or "High," then engage the media clamps. Depending on the media, the edges of the media may warp due to heat or the media may strike the printing heads, causing jams or malfunction.

2-3 Printing and Cutting

Printing

Before performing printing, set the preset temperature to 40°C (104°F) and wait until media becomes sufficiently warm. For information on how to perform printing, refer to the user's manual for the printer.

Notice

The recommended ambient temperature for ensuring acceptable quality when performing printing is 20 to 32°C (68 to 89.6°F). When the ambient temperature is less than 20°C, the media doesn't heat up enough to ensure acceptable quality. In such cases, set the preset temperature to higher value.

- 1 After loading media, set [SV] on the controller to 40°C.

It may take from few minutes to approximately 30 minutes to reach the preset temperature, depending on the ambient temperature.



- 2 To heat the media sufficiently, wait for five minutes after making sure that the [PV] on the controller reaches 40°C.

Then perform printing.



Point

The setting range of preset temperature by the controller is 30 to 50°C (86 to 122°F).

Performing printing as soon as the heater temperature reaches 40°C may result in coarse printing because the media is not warm enough.

When the heater reaches the preset temperature, the [C1] indicator goes dark and the heater stops operating. The heater is switched on and off automatically to maintain the preset temperature. Meanwhile the [C1] indicator lights up and goes dark to indicate the status of the heater.

Cutting/Printing and Cutting

This section explains printers equipped with a cutting function.



Notice

Do not use the media clamps during cutting.

Assurance of Accuracy When Performing Printing and Cutting

When the heater is used, the media may experience subtle deformation due to thermal expansion or contraction. For this reason, no assurance is made with respect to the following points when the heater is used.

- Distance accuracy (when cutting)
- Repetition accuracy (when cutting)
- Repetition between printing and cutting
- Alignment accuracy for printing and cutting when reloading media



Point

Using crop marks when performing printing and cutting, even when these are performed simultaneously, may help reduce misalignment. After printing, it is a good idea to allow the heater to cool before performing cutting.

1. Carry out only printing, with crop marks.
2. Switch off the controller to turn off the heater, and allow the media and platen to cool sufficiently.
3. Use the crop marks to align.
4. Carry out only cutting.

For detailed information about aligning using crop marks, refer to the user's manual for the printer.

To Perform Cutting Only

Before performing cutting, switch off the controller to turn off the heater, and allow the platen to cool sufficiently.

2-4 What to Do If ...

■ The results of printing are coarse.

The results of printing may be coarse when the media is not warm enough. In particular, the edges of the media tend not to become as warm as the center, which may result in ink drips or unevenness, depending on the printing data. If this happens, increase the preset temperature and perform printing again. If the printing results don't improve even when you increase the preset temperature, the ambient temperature may be too low. Be sure to perform printing in the recommended operating environment.

Setting the [SCAN INTERVAL] menu item for the printer may improve printing quality. Please refer to "3-2 Additional Menus on the Printer."

■ Media wrinkles when performing printing.

Depending on the type of media, it may wrinkle when performing printing after it is left on the platen for 30 minutes to an hour with the heater temperature at 40°C. When you are not printing continuously, remove the media or reduce the preset temperature to 30°C.

■ Media warps before performing printing.

Depending on the type of media, it may tend to warp when there is a large difference between the ambient temperature and the heater temperature.

If the left and right edges of the media warp . . .

Use media clamps.

If the front edge of the media warps . . .

Reduce the heater temperature or increase the ambient temperature.

It may be possible to prevent media from warping by setting the [VACUUM POWER] menu item of the printer. Please refer to "3-2 Additional Menus on the Printer."

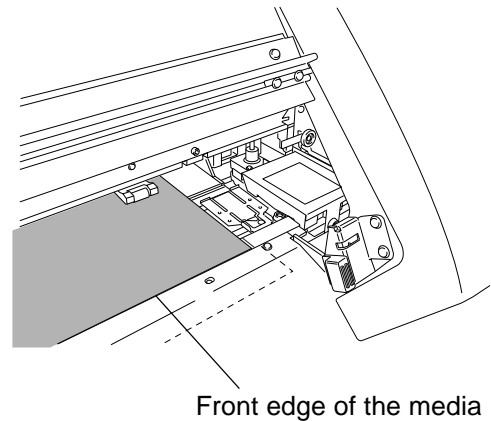

3. Other Information

This section describes daily maintenance, additional menus on the printer, and specifications.

3-1 Daily Maintenance



When cleaning the platen, first switch off the controller and the sub power for the printer. Failure to do so may cause burns when the platen is hot.



Never clean with solvents (such as benzine or thinners). Doing so may cause fire when the platen is hot.



Notice

Periodically clean the platen. Buildup of grime may soil printed media and make correct detection of media width impossible.

■ **Cleaning the Platen**

Moisten a cloth with neutral detergent diluted with water, wring dry, and wipe gently.

For buildup of cutting dust on the platen, use a commercially available brush to brush it away toward the front. When doing this, never use a metal brush.

■ **Cleaning the Controller**

Use a cloth moistened with water then wrung well, and wipe gently to clean. Wipe the control panel and display gently with a clean, soft cloth.

3-2 Additional Menus on the Printer

Installing the heater unit adds the following menus to the printer.

FULL WIDTH S SCAN INTERVAL VACUUM POWER

To make the settings for these menus, follow the instructions below.

Depending on the menu, replace the display of screens 1 and 2 with the respective figures in the following table.

For detailed information about each menu, refer to the following table.

- 1 Press the [MENU] key, then press the [▼] key to make screen 1 appear on the display.

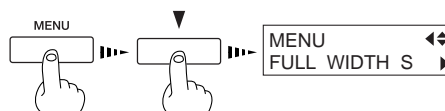

Screen 1

- 2 Press the [▶] key to display screen 2.

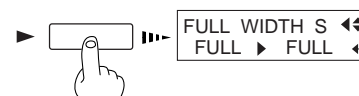

Screen 2

- 3 Use the [▼] and [▲] keys to select the desired value.

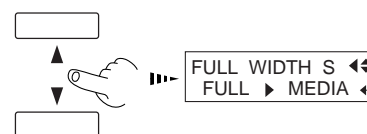

- 4 Press the [ENTER] key.

Menu Description

Screen 1	Screen 2	Function	Setting range	Default value
		<p>This sets the movement width of the printing carriage when printing.</p> <p>Using this function may improve printing quality by maintaining a uniform speed for media feed. However, printing may take more time.</p> <p>When using the heater, be sure to set this menu item to [FULL].</p> <p>[FULL]: The movement width of the printing carriage is always the full width. [MEDIA]: The width changes depending on the width of the media. [OFF]: The width changes according to the printing data.</p>	FULL/ MEDIA/OFF	FULL
		<p>This sets the ink-drying time.</p> <p>If problems with ink stains occur, setting this value to a longer time may improve printing quality.</p>	OFF/ 0.1 to 10.0 sec (in steps of 0.1 sec)	OFF
		<p>This adjusts the suction force of the fan installed under the platen to make the media contact the platen.</p> <p>Adjust this value when the media warps due to heat or sticks to the platen. Increasing the value makes the suction force stronger, but because it lowers the temperature of the platen, the media may become difficult to warm.</p> <p>[AUTO]: The suction force is adjusted automatically according to the width of media. [0 to 100%] (in steps of 10%): The suction force remains constant at the set value.</p>	AUTO/ 0 to 100% (in steps of 10%)	AUTO

3-3 Specifications

Heater Unit Specifications

		HU-740	HU-640	HU-540
Installable printer		SJ-740	SJ-640	SJ-540/SC-540
On/off control of the heater		Dedicated power switch and an internal switch interlinked with the sub power for the printer		
Setting range for the preset temperature		30 to 50°C (86 to 122°F) (*1)		
Power supply		AC 117 V, 200 to 240 V ± 10%, 50/60 Hz		
Power consumption	Operational	Maximum 5.6 A (117 V), 2.6 A (220 to 240 V)	Maximum 4.9 A (117 V), 2.2 A (220 to 240 V)	Maximum 3.6 A (117 V), 1.9 A (220 to 240 V)
	Standby	Maximum 0.1 A		
Weight		6.3 kg (13.9 lb.)	5.9 kg (13 lb.)	5.5 kg (12.1 lb.)
Packed dimensions		2100 [W] x 300 [D] x 340 [H] mm (82-11/16 [W] x 11-13/16 [D] x 13-7/16 [H] in.)	–	1610 [W] x 300 [D] x 340 [H] mm (63-11/16 [W] x 11-13/16 [D] x 13-7/16 [H] in.)
Packed weight		15.5 kg (34.2 lb.)	–	13.2 kg (29.1 lb.)
Included items		power cord: 1, user's manual: 1		

*1 The heater temperature may not reach the preset temperature depending on ambient conditions or the width of the media. Unevenness in temperature may be larger depending on ambient conditions or the width of the media.

Printer Specifications When the Heater Unit Is Installed

The specifications of the printer change when the heater unit is installed. In the "Main Unit Specifications" for your printer, replace or add the following items.

	SJ-740	SJ-640	SJ-540	SC-540
Distance accuracy (For printing while the heater is running)	Error of less than ± 0.3% of distance traveled, or 0.3 mm, whichever is greater (at SV-G-1270G, print travel: 1 m, temperature: 20°C (68°F), humidity: 50%, heater temperature: 40°C (104°F))			
Acceptable media width (For printing with the heater)	500 to 1879 mm (19-11/16 to 74 in.)	500 to 1625 mm (19-11/16 to 64 in.)	500 to 1371 mm (19-11/16 to 54 in.)	
Ink cartridge	Exclusive ECO-SOL INK cartridge			
Dimensions (with stand)	3309 [W] x 742 [D] x 1369 [H] mm (130-5/16 [W] x 29-1/4 [D] x 53-15/16 [H] in.)	3053 [W] x 742 [D] x 1300 [H] mm (120-1/4 [W] x 29-1/4 [D] x 51-3/16 [H] in.)	2880 [W] x 742 [D] x 1369 [H] mm (113-7/16 [W] x 29-1/4 [D] x 53-15/16 [H] in.)	
Weight (with stand)	179 kg (394.6 lb.)	175 kg (385.8 lb.)	151 kg (332.9 lb.)	157 kg (346.1 lb.)
Recommended operating environment	Temperature: 20 to 32°C (68 to 89.6°F), humidity: 35 to 80% (non-condensing) (*2)			

*2 Operating environment

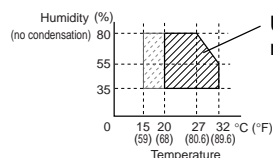

*3 For the SC-540, the following items are not guaranteed when cutting while using the heater. Please refer to the SC-540 User's Manual.

- Distance accuracy (when cutting)
- Repetition accuracy (when cutting)
- Repetition between printing and cutting
- Alignment accuracy for printing and cutting when reloading media