

Owner's Manual  
Bedienungsanleitung  
Mode d'emploi  
Manual de instrucciones



YAMAHA

# Clavinova®

CLP-880

CLP-880M

CLP-880PE

CLP-860

CLP-860M

CLP-840

CLP-820

CLP-820S

## IMPORTANT

### Check your power supply

Make sure that your local AC mains voltage matches the voltage specified on the name plate on the bottom panel. In some areas a voltage selector may be provided on the bottom panel of the main keyboard unit near the power cord. Make sure that the voltage selector is set for the voltage in your area. The voltage selector is set at 240V when the unit is initially shipped. To change the setting use a "minus" screwdriver to rotate the selector dial so that the correct voltage appears next

## WICHTIG

### Überprüfung der Stromversorgung

Überprüfen Sie sich vor dem Anschließen an das Stromnetz, daß die örtliche Netzspannung den Betriebsspannungswerten auf dem Typenschild an der Unterseite des Instruments entspricht. In bestimmten Verkaufsgebieten ist das Instrument mit einem Spannungswähler an der Unterseite neben der Netzkabeldurchführung ausgestattet. Falls vorhanden, muß der Spannungswähler auf die örtliche Netzspannung eingestellt werden. Der Spannungswähler wurde werkseitig auf 240 V voreingestellt. Zum Verstellen drehen Sie den

## IMPORTANT

### Contrôler la source d'alimentation

Vérifiez que la tension spécifiée sur le panneau inférieur correspond à la tension du secteur. Dans certaines régions, l'instrument peut être équipé d'un sélecteur de tension situé sur le panneau inférieur du clavier à proximité du cordon d'alimentation. Vérifiez que ce sélecteur est bien réglé en fonction de la tension secteur de votre région. Le sélecteur de tension est réglé sur 240 V au départ d'usine. Pour modifier ce réglage, utilisez un tournevis à lame plate pour tourner le sélecteur afin de mettre l'indication corres-

## IMPORTANTE

### Verifique la alimentación de corriente

Asegúrese de que tensión de alimentación de CA de su área corresponde con la tensión especificada en la placa de características del panel inferior. En algunas zonas puede haberse incorporado un selector de tensión en el panel inferior de la unidad del teclado principal, cerca del cable de alimentación. Asegúrese de que el selector de tensión esté ajustado a la tensión de su área. El selector de tensión se ajusta a 240V cuando la unidad sale de fábrica. Para cambiar el ajuste, emplee un destornillador de cabeza "recta" para girar el

ENGLISH

DEUTSCHE

FRANÇAIS

ESPAÑOL

# SPECIAL MESSAGE SECTION

**PRODUCT SAFETY MARKINGS:** Yamaha electronic products may have either labels similar to the graphics shown below or molded/stamped facsimiles of these graphics on the enclosure. The explanation of these graphics appears on this page. Please observe all cautions indicated on this page and those indicated in the safety instruction section.

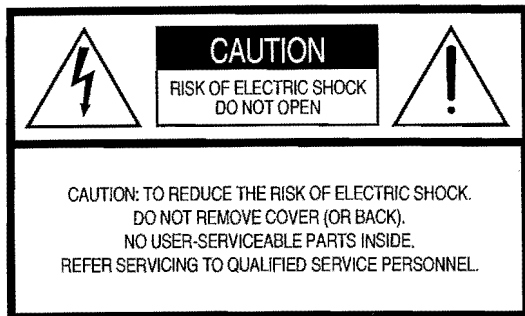

See bottom of Keyboard enclosure for graphic symbol markings



The exclamation point within the equilateral triangle is intended to alert the user to the presence of important operating and maintenance (servicing) instructions in the literature accompanying the product.



The lightning flash with arrowhead symbol, within the equilateral triangle, is intended to alert the user to the presence of uninsulated "dangerous voltage" within the product's enclosure that may be of sufficient magnitude to constitute a risk of electrical shock.

**IMPORTANT NOTICE:** All Yamaha electronic products are tested and approved by an independent safety testing laboratory in order that you may be sure that when it is properly installed and used in its normal and customary manner, all foreseeable risks have been eliminated. **DO NOT** modify this unit or commission others to do so unless specifically authorized by Yamaha. Product performance and/or safety standards may be diminished. Claims filed under the expressed warranty may be denied if the unit is/has been modified. Implied warranties may also be affected.

**SPECIFICATIONS SUBJECT TO CHANGE:** The information contained in this manual is believed to be correct at the time of printing. However, Yamaha reserves the right to change or modify any of the specifications without notice or obligation to update existing units.

**ENVIRONMENTAL ISSUES:** Yamaha strives to produce products that are both user safe and environmentally friendly. We sincerely believe that our products and the production methods used to produce them, meet these goals. In keeping with both the letter and the spirit of the law, we want you to be aware of the following:

**Battery Notice:** This product **MAY** contain a small non-rechargeable battery which (if applicable) is soldered in place. The average life span of this type of battery is approximately five years. When replacement becomes necessary, contact a qualified service representative to perform the replacement.

**Warning:** Do not attempt to recharge, disassemble, or incinerate this type of battery. Keep all batteries away from children. Dispose of used batteries promptly and as regulated by applicable laws. Note: In some areas, the servicer is required by law to return the defective parts. However, you do have the option of having the servicer dispose of these parts for you.

**Disposal Notice:** Should this product become damaged beyond repair, or for some reason its useful life is considered to be at an end, please observe all local, state, and federal regulations that relate to the disposal of products that contain lead, batteries, plastics, etc.

**NOTICE:** Service charges incurred due to lack of knowledge relating to how a function or effect works (when the unit is operating as designed) are not covered by the manufacturer's warranty, and are therefore the owners responsibility. Please study this manual carefully and consult your dealer before requesting service.

**NAME PLATE LOCATION:** The graphic below indicates the location of the name plate. The model number, serial number, power requirements, etc., are located on this plate. You should record the model number, serial number, and the date of purchase in the spaces provided below and retain this manual as a permanent record of your purchase.

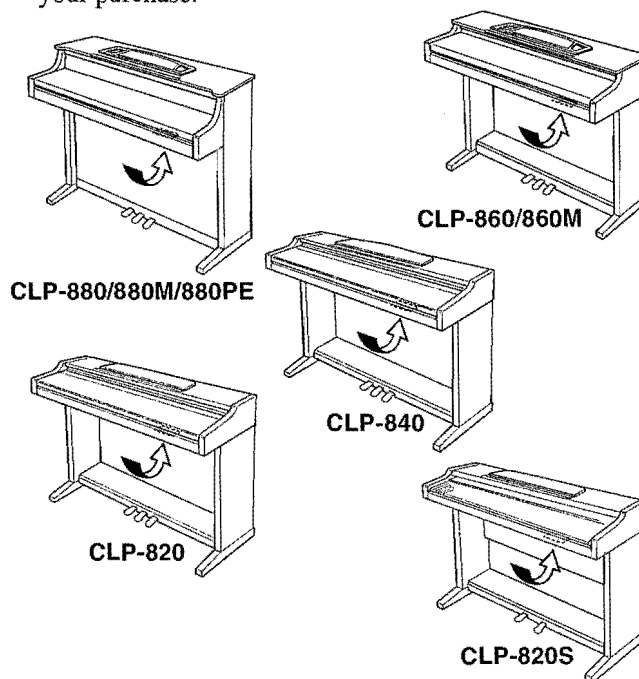

Model \_\_\_\_\_

Serial No. \_\_\_\_\_

# PRECAUTIONS

## PLEASE READ CAREFULLY BEFORE PROCEEDING

\* Please keep these precautions in a safe place for future reference.



### WARNING

Always follow the basic precautions listed below to avoid the possibility of serious injury or even death from electrical shock, short-circuiting, damages, fire or other hazards. These precautions include, but are not limited to, the following:

- Do not open the instrument or attempt to disassemble the internal parts or modify them in any way. The instrument contains no user-serviceable parts. If it should appear to be malfunctioning, discontinue use immediately and have it inspected by qualified Yamaha service personnel.
- Do not expose the instrument to rain, use it near water or in damp or wet conditions, or place containers on it containing liquids which might spill into any openings.
- If the power cord or plug becomes frayed or damaged, or if there is a sudden loss of sound during use of the instrument, or if any unusual smells or smoke should appear to be caused by it, immediately turn off the power switch, disconnect the electric plug from the outlet, and have the instrument inspected by qualified Yamaha service personnel.
- Only use the voltage specified as correct for the instrument. The required voltage is printed on the name plate of the instrument.
- Before cleaning the instrument, always remove the electric plug from the outlet. Never insert or remove an electric plug with wet hands.
- Check the electric plug periodically and remove any dirt or dust which may have accumulated on it.



### CAUTION

Always follow the basic precautions listed below to avoid the possibility of physical injury to you or others, or damage to the instrument or other property. These precautions include, but are not limited to, the following:

- Do not place the power cord near heat sources such as heaters or radiators, and do not excessively bend or otherwise damage the cord, place heavy objects on it, or place it in a position where anyone could walk on, trip over, or roll anything over it.
  - When removing the electric plug from the instrument or an outlet, always hold the plug itself and not the cord. Pulling by the cord can damage it.
  - Do not connect the instrument to an electrical outlet using a multiple-connector. Doing so can result in lower sound quality, or possibly cause overheating in the outlet.
  - Remove the electric plug from the outlet when the instrument is not to be used for extended periods of time, or during electrical storms.
  - Before connecting the instrument to other electronic components, turn off the power for all components. Before turning the power on or off for all components, set all volume levels to minimum.
  - Do not expose the instrument to excessive dust or vibrations, or extreme cold or heat (such as in direct sunlight, near a heater, or in a car during the day) to prevent the possibility of panel disfiguration or damage to the internal components.
  - Do not use the instrument near other electrical products such as televisions, radios, or speakers, since this might cause interference which can affect proper operation of the other products.
  - Do not place the instrument in an unstable position where it might accidentally fall over.
  - Before moving the instrument, remove all connected cables.
  - When cleaning the instrument, use a soft, dry cloth. Do not use paint thinners, solvents, cleaning fluids, or chemical-impregnated wiping cloths. Also, do not place vinyl, plastic or rubber objects on the instrument, since this might discolor the panel or keyboard.
  - On the CLP-880PE, gently remove dust and dirt with a soft cloth. Do not wipe too hard since small particles of dirt can scratch the instrument's finish.
  - On the CLP-880PE, bumping the surface of the instrument with metal, porcelain, or other hard objects can cause the finish to crack or peel. Use caution.
  - Do not rest your weight on, or place heavy objects on the instrument, and do not use excessive force on the buttons, switches or connectors.
  - (For instruments with a key cover) Take care that the key cover does not pinch your fingers, and do not insert a finger or hand in the key cover gap.
  - (For instruments with a key cover) Never insert or drop paper or metallic or other objects between the slits of the key cover and the keyboard. If this happens, immediately turn off the power and remove the electric plug from the outlet and have the instrument inspected by qualified Yamaha service personnel.
  - Do not place the instrument against a wall (allow at least 3 cm/one-inch from the wall), since this can cause inadequate air circulation, and possibly result in the instrument overheating.
  - Read carefully the attached documentation explaining the assembly process. Failure to assemble the instrument in the proper sequence might result in damage to the instrument or even injury.
  - Do not operate the instrument for a long period of time at a high or uncomfortable volume level, since this can cause permanent hearing loss. If you experience any hearing loss or ringing in the ears, consult a physician.
- #### ■ USING THE BENCH (if included)
- Do not play carelessly with or stand on the bench. Using it as a tool or step-ladder or for any other purpose might result in accident or injury.
  - Only one person should sit on the bench at a time, in order to prevent the possibility of accident or injury.
  - (For height-adjustable benches) Do not attempt to adjust the bench height while sitting on the bench, since this can cause excessive force to be imposed on the adjustment mechanism, possibly resulting in damage to the mechanism or even injury.
  - If the bench screws become loose due to extensive long-term use, tighten them periodically using the included tool.
- #### ■ SAVING USER DATA
- Save all data to an external device such as the Yamaha MIDI Data Filer MDF3, in order to help prevent the loss of important data due to a malfunction or user operating error.

Yamaha cannot be held responsible for damage caused by improper use or modifications to the instrument or data that is lost or destroyed.

## Introduction

---

*Thank you for choosing a Yamaha Clavinova. Your Clavinova is a fine musical instrument that employs advanced Yamaha music technology. With the proper care, your Clavinova will give you many years of musical pleasure.*

- Stereo sampling of the acoustic piano voices offers unmatched realism and expressive power, while the AWM (Advanced Wave Memory) tone generator system offers rich, realistic reproductions of all other voices.
- Piano-like touch response — adjustable in 4 stages — provides extensive expressive control and outstanding playability.
- Dual mode allows 2 voices to be played simultaneously.
- Split mode (CLP-880/860) allows different voices to be played by the left and right hands.
- On the CLP-880/860, damper pedal includes natural resonance effect for the piano voices, simulating the string and sound-board resonance of acoustic pianos.
- Metronome feature with variable tempo facilitates practice.
- 2-track digital recorder lets you record and play back anything you play on the keyboard.
- MIDI compatibility and a range of MIDI functions make the Clavinova useful in a range of advanced MIDI music systems.
- Built-in computer interface for direct connection to personal computers running advanced music software.

In order to make the most of your Clavinova's performance potential and features, we urge you to read this Owner's Manual thoroughly, and keep it in a safe place for later reference.

\* The models CLP-880M, CLP-880PE and CLP-860M will be referred to as the CLP-880 and CLP-860 in this Owner's Manual.

### Included Accessories

- Owner's Manual
- Bench (included or optional depending on locale)
- Dust Cover (CLP-820S only)

# Contents

<b>The Control Panel</b> .....	6	F3.4: 2nd Voice Octave Shift .....	29
<b>Key Cover &amp; Music Stand</b> .....	8	F3.5: 1st Voice Effect Depth (CLP-880/860/840) .....	30
<b>Connections</b> .....	10	F3.6: 2nd Voice Effect Depth (CLP-880/860/840) .....	30
<b>Selecting &amp; Playing Voices</b> .....	11	F3.5: Reset (CLP-820/820S) .....	30
<b>Playing the Demonstration Tunes</b> .....	12	F3.7: Reset (CLP-880/860/840) .....	30
■ <b>Voice Demo</b> .....	12	■ <b>F4: CLP-880/860 Split Mode Functions</b> .....	30
■ <b>Piano Song</b> .....	13	F4.1: Split Point .....	30
■ <b>Piano Song A-B Repeat</b> .....	14	F4.2: Split Balance .....	30
■ <b>Piano Song Part Cancel</b> .....	15	F4.3: Right Voice Octave Shift .....	31
• Synchro Start .....	15	F4.4: Left Voice Octave Shift .....	31
• Left Pedal Start/Stop .....	15	F4.5: Right Voice Effect Depth .....	31
<b>The Dual Mode</b> .....	16	F4.6: Left Voice Effect Depth .....	31
• Other Dual Mode Functions .....	16	F4.7: Damper Range .....	31
<b>The Split Mode (CLP-880/860)</b> .....	17	F4.8: Reset .....	31
• Selecting the Right and Left Voices .....	17	■ <b>F4: CLP-840/820/820S Left Pedal Mode</b> .....	32
• Setting the Split Point .....	17	■ <b>F5: CLP-880/860 Pedal Functions</b> .....	32
• Other Split Mode Functions .....	17	F5.1: Left Pedal Mode .....	32
<b>Reverb</b> .....	18	F5.2: Damper Mode .....	32
• Adjusting Reverb Depth .....	18	F5.3: Soundboard Depth .....	32
<b>The Effect (CLP-880/860/840)</b> .....	19	■ <b>F5: CLP-840/820/820S Metronome Volume</b> .....	33
• Adjusting Effect Depth .....	19	■ <b>F6: CLP-880/860 Metronome Volume</b> .....	33
<b>Brilliance (CLP-880/860/840)</b> .....	19	■ <b>F6: CLP-840/820/820S Piano Song Part Cancel Volume</b> ..	33
<b>The Pedals</b> .....	20	■ <b>F7: CLP-880/860 Piano Song Part Cancel Volume</b> .....	33
• Damper (Right) Pedal .....	20	■ <b>F7: CLP-840/820/820S MIDI Functions</b> .....	34
• Sostenuto (Center) Pedal (except for CLP-820S) .....	20	■ <b>F8: CLP-880/860 MIDI Functions</b> .....	34
• Soft (Left) Pedal .....	20	• A Brief Introduction to MIDI .....	34
<b>Touch Sensitivity</b> .....	21	F7.1/F8.1: MIDI Transmit Channel Selection .....	34
<b>Transposition</b> .....	21	F7.2/F8.2: MIDI Receive Channel Selection .....	34
<b>Tuning</b> .....	22	F7.3/F8.3: Local Control ON/OFF .....	35
• Tuning Up .....	22	F7.4/F8.4: Program Change ON/OFF .....	35
• Tuning Down .....	22	F7.5/F8.5: Control Change ON/OFF .....	36
• To Restore Standard Pitch .....	22	F7.6/F8.6: MIDI Transmit Transpose .....	36
<b>The Metronome &amp; Tempo Control</b> .....	23	F7.7/F8.7: Panel/Status Transmit .....	36
■ <b>The Metronome</b> .....	23	F7.8/F8.8: Bulk Data Dump .....	36
• Metronome Time Signature .....	23	■ <b>F8: CLP-840/820/820S Backup Functions</b> .....	37
• Metronome Volume Function .....	23	■ <b>F9: CLP-880/860 Backup Functions</b> .....	37
■ <b>Tempo Control</b> .....	23	F8.1/F9.1: Voice .....	37
<b>Using the Recorder</b> .....	24	F8.2/F9.2: MIDI .....	37
■ <b>Recording</b> .....	24	F8.3/F9.3: Tuning .....	37
• Changing the Initial Settings .....	25	F8.4/F9.4: Pedal .....	37
• Erasing a Single Track .....	25	<b>Connecting to a Personal Computer</b> .....	38
■ <b>Playback</b> .....	26	• Connecting to an Apple Macintosh Series Computer ....	38
• Synchro Start .....	26	• Connecting to an IBM-PC/AT Series Computer .....	39
• Left Pedal Start/Stop .....	26	<b>Factory Preset Recall</b> .....	40
<b>The Function Mode</b> .....	27	<b>Troubleshooting</b> .....	40
• To Select a Function .....	27	<b>Options &amp; Expander Modules</b> .....	40
■ <b>F1: Tuning</b> .....	28	<b>Demo and Piano Song List</b> .....	41
■ <b>F2: Scale</b> .....	28	<b>Factory Setting List</b> .....	42
F2.1: Scale .....	28	<b>MIDI Data Format</b> .....	43
F2.2: Base Note .....	28	<b>MIDI Implementation Chart</b> .....	47
■ <b>F3: Dual Mode Functions</b> .....	29	<b>CLP-880: Keyboard Stand Assembly</b> .....	48
F3.1: Dual Balance .....	29	<b>CLP-860/840/820: Keyboard Stand Assembly</b> .....	56
		<b>CLP-880: Keyboard Stand Assembly</b> .....	60

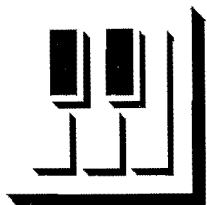

# The Control Panel

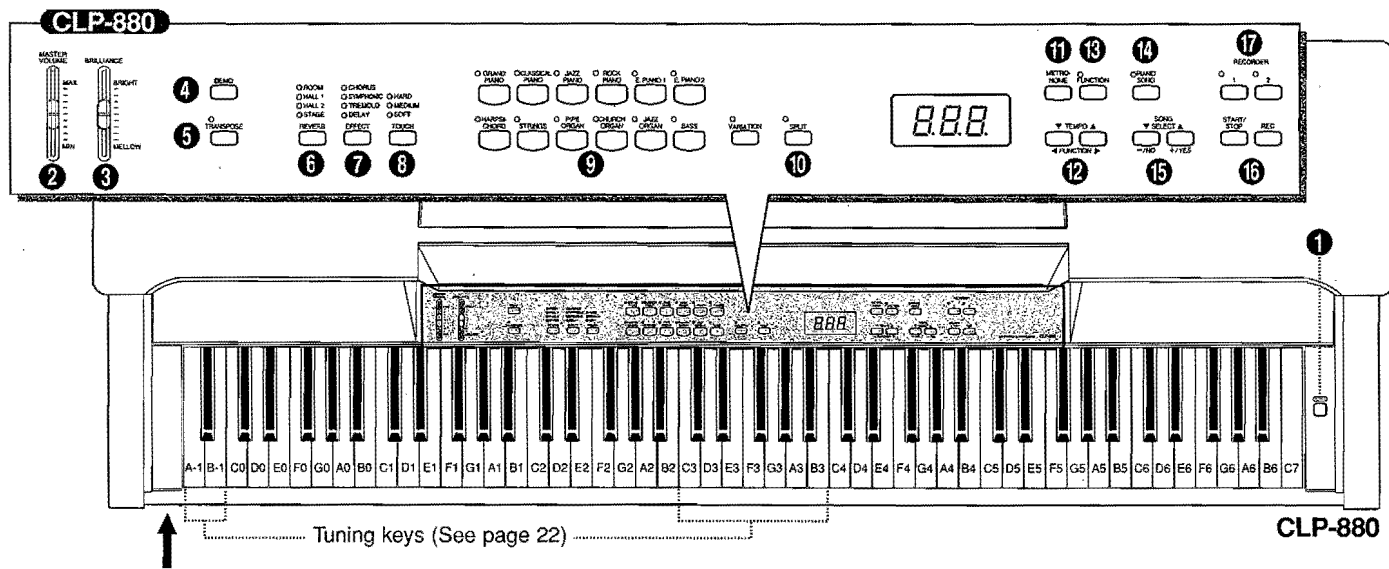
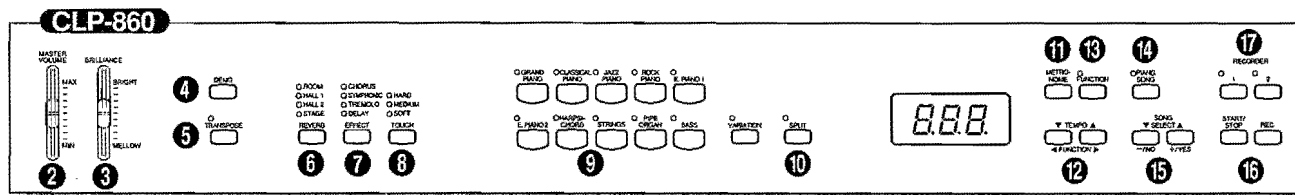
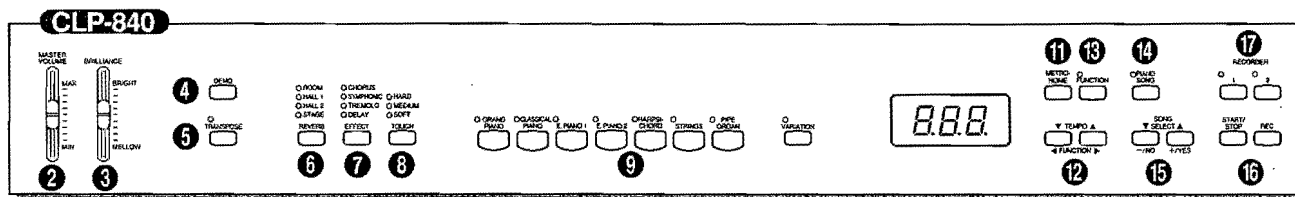
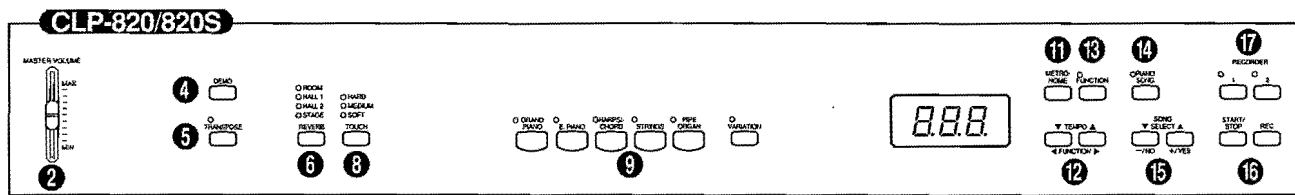

↑ PHONES Jacks (Bottom panel) (See page 10)

## 1 [POWER] Switch

Press the [POWER] switch once to turn the power ON, a second time to turn the power OFF. When the power is initially turned ON, a voice selector LED will light, and the power indicator located below the left of the keyboard will light (except for CLP-820S).

## 2 [MASTER VOLUME] Control

The [MASTER VOLUME] control adjusts the volume (level) of sound produced by the Clavinova's internal stereo sound system. The [MASTER VOLUME] control also adjusts head-

phone volume when a pair of headphones is plugged into the PHONES jack (page 10).

## 3 [BRILLIANCE] Control (CLP-880/860/840)

The [BRILLIANCE] Control adjusts the tonality or "timbre" of the output sound from a mellow tone to a bright tone.

## 4 [DEMO] Button

Activates the demo playback mode in which you can select playback of different demonstration sequences for each of the Clavinova's voices. See page 12 for details.

## 5 [TRANSCOPE] Button

The [TRANSCOPE] button allows access to the Clavinova's TRANSCOPE function (to shift the pitch of the entire keyboard up or down in semitone intervals).

## 6 [REVERB] Button

The [REVERB] button selects a number of digital reverb effects that you can use for extra depth and expressive power. See page 18 for details.

## 7 [EFFECT] Button (CLP-880/860/840)

This button selects a number of effects which can give your sound greater depth and animation.

## 8 [TOUCH] Button

The [TOUCH] button makes it easy to adjust the touch response of the Clavinova to match your playing style. See page 21 for details.

## 9 Voice Selectors & [VARIATION] Button

Simply press any of the voice selectors to select the corresponding voice. The voice selector LED will light to indicate which voice is currently selected. Press the [VARIATION] button so that its indicator lights to select a variation of the currently selected voice.

There is also a dual mode in which two voices can be played simultaneously across the full range of the keyboard (see page 16 for details), and a split mode on the CLP-880/860 which allows different voices to be played by the left and right hands (see page 17 for details).

## 10 [SPLIT] Button (CLP-880/860)

Engages the split mode, in which different voices can be played on the left- and right-hand sections of the keyboard. See page 17 for details.

## 11 [METRONOME] Button

Turns the metronome sound on and off. The [TEMPO ▼/▲] buttons, below, are used to set the tempo of the metronome sound. The [–/NO] and [+ /YES] buttons are used to change the time signature (beat) of the metronome if used while the [METRONOME] button is held — page 23.

## 12 [TEMPO ▼/▲] (FUNCTION ◀/▶) Buttons

These buttons adjust the tempo of the metronome function as well as the playback tempo of the re-

order function. The tempo range is from 32 to 280 beats per minute — page 23. These same buttons are also used to select functions — page 27.

## 13 [FUNCTION] Button

This button accesses a range of utility functions — including the MIDI functions — that significantly enhance versatility and playability. See page 27 for details.

## 14 [PIANO SONG] Button

This button enters the Piano Song Mode. While in this mode you can use the [SONG SELECT ▼/▲] buttons to select from 50 songs.

## 15 [SONG SELECT ▼/▲] (–/NO, +/YES) Buttons

These buttons select a piano song number for playback, and are also used to adjust a range of other parameters (i.e. their “–/NO” and “+/YES” functions).

## 16 RECORDER [START/STOP] and [REC] Buttons

These buttons control the Clavinova's recorder, letting you record and play back just about anything you play on the keyboard.

## 17 RECORDER [1] and [2] Buttons

The Clavinova has a 2-track recorder, and these buttons are used to select the track(s) to be recorded or played back. See page 24 for details.

## 18 Pedals

The soft (left), sostenuto (center) and damper (right) pedals (soft/sostenuto [left] and damper [right] in the case of the CLP-820S) provide a range of expressive control capabilities similar to the pedal functions on an acoustic piano. See page 20 for details.

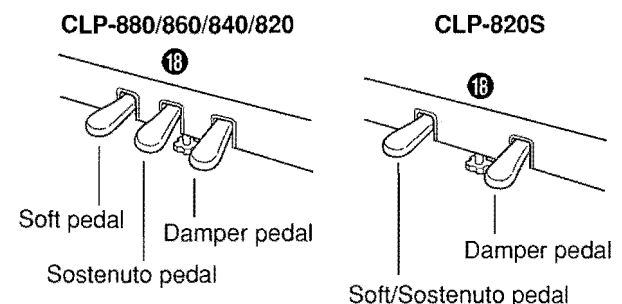

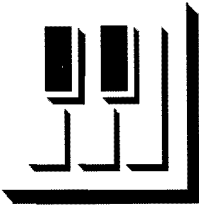

# Key Cover & Music Stand

## Key Cover (except for CLP-820S)

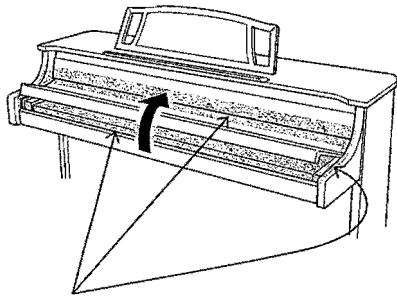

Be careful to avoid catching your fingers when opening or closing the cover.

### ■ CLP-880 .....

#### To open the key cover:

Gently lift the cover until it is fully open.

#### To close the key cover:

Gently lower the cover over the keys.

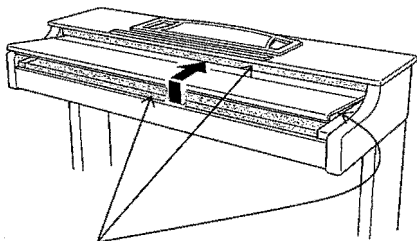

Be careful to avoid catching your fingers when opening or closing the cover.

### ■ CLP-860/840/820 .....

#### To open the key cover:

- 1 Lift the cover slightly (not too much).
- 2 Slide the cover open.

#### To close the key cover:

- 1 Slide the cover toward you.
- 2 Gently lower the cover over the keys.

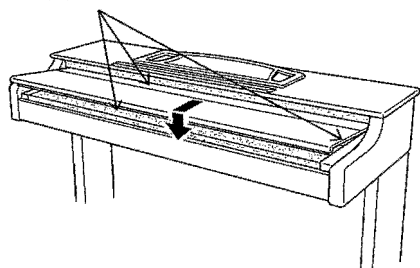

- Hold the cover with both hands when moving it, and do not release it until it is fully opened or closed. Be careful to avoid catching fingers (yours or others) between the cover and main unit.
- Do not place objects on top of the key cover. Small objects placed on the key cover may fall inside the main unit when the cover is opened and may not be able to be removed. This could cause electric shock, short circuit, fire or other serious damage to the instrument.



## Music Stand

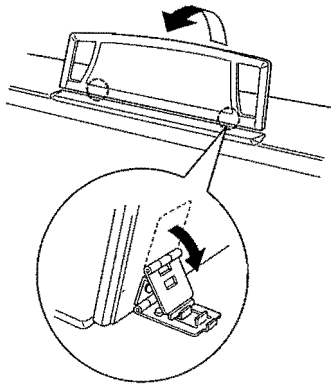

### To raise the music stand:

- 1** Pull the stand up and toward yourself as far as it will go.
- 2** Flip down the two metal supports at the left and the right on the rear of the music stand.
- 3** Lower the music stand so that it rests on the metal supports.

As shown in the illustration, the angle of the music stand can be set in one of three positions, according to the position of the metal supports. Set the left and right metal supports to the same position.

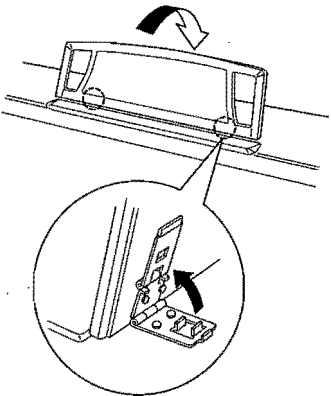

### To lower the music stand:

- 1** Pull the music stand toward yourself as far as it will go.
- 2** Raise the two metal supports (at the rear of the stand).
- 3** Gently lower the music stand backward until it is all the way down.



**CAUTION** • Do not try to use the music stand in a half-raised position. When lowering the stand, do not release your hands from the music stand until it is all the way down.



# Connections

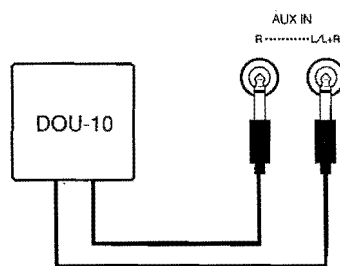
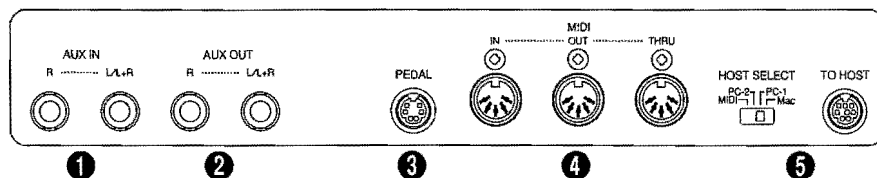

## 1 AUX IN L/L+R and R Jacks

These jacks are intended for use with an external tone generator module such as the Yamaha DOU-10 Disk Orchestra Unit. The stereo outputs from the external tone generator module are connected to the AUX IN L/L+R and R jacks, allowing the sound of the tone generator to be reproduced via the Clavinova's internal sound system and speakers. A line-level mono source can be connected to the L/L+R jack.



**NOTE** • The input signal from the AUX IN jacks is controlled by the Clavinova's volume and brilliance (CLP-880/860/840) controls. Reverb and effect (CLP-880/860/840) functions will have no affect.

• The input signal from the AUX IN jacks is delivered to the AUX OUT jacks.

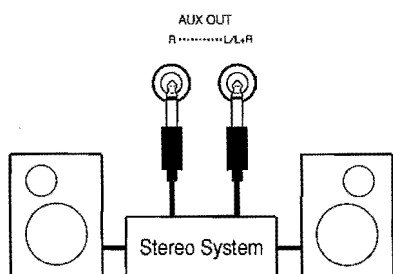

## 2 AUX OUT L/L+R and R Jacks

The AUX OUT L/L+R and R jacks deliver the output of the Clavinova for connection to an instrument amplifier, mixing console, PA system, or recording equipment. If you will be connecting the Clavinova to a monaural sound system, use only the L/L+R jack. When a plug is inserted into the L/L+R jack only, the left- and right-channel signals are combined and delivered via the L/L+R jack so you don't lose any of the Clavinova's sound.



**NOTE** • The AUX OUT jack signal must never be returned to the AUX IN jacks, either directly or through external equipment.

• The AUX OUT jack signal is not controlled by the Clavinova's volume control. Use the volume control on the external audio equipment to adjust the level.

## 3 PEDAL Jack

This terminal is for connecting the pedal cord from the pedal box (refer to the "Keyboard Stand Assembly" on pages 48-67).

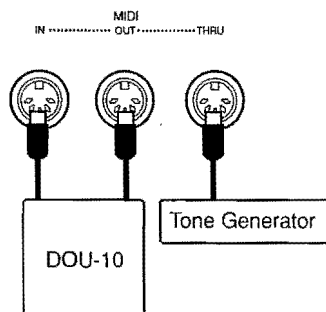

## 4 MIDI IN, THRU and OUT Connectors

The MIDI IN connector receives MIDI data from an external MIDI device (such as the DOU-10 Disk Orchestra Unit) which can be used to control the Clavinova. The MIDI THRU connector re-transmits any data received at the MIDI IN connector, allowing "chaining" of several MIDI instruments or other devices. The MIDI OUT connector transmits MIDI data generated by the Clavinova (e.g. note and velocity data produced by playing the Clavinova keyboard).

More details on MIDI are given in "MIDI Functions" on page 34.

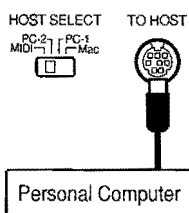

## 5 TO HOST Connector & HOST SELECT Switch

This jack and selector switch allow direct connection to a personal computer for sequencing and other music applications — without the need for a separate MIDI interface. See page 38 for details.

## ● PHONES Jacks (Bottom Panel)

Two sets of standard stereo headphones can be plugged in here for private practice or late-night playing. The internal speaker system is automatically shut off when a pair of headphones is plugged into either of the



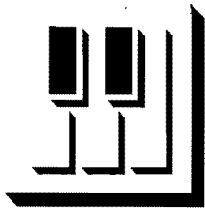

# Selecting & Playing Voices

## 1 Turn Power On .....

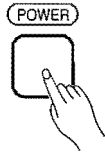

After making sure that the Clavinova's AC cord is properly plugged into the Clavinova itself and plugged into a convenient AC wall outlet, press the [POWER] switch located to the right of the keyboard to turn the power ON. In some areas a plug adaptor may be provided to match the pin configuration of the AC wall outlets in your area.

When the power is turned ON, one of the voice selector LEDs will light, and the power indicator located below the left end of the keyboard will light (except for CLP-820S).

## 2 Set the Volume .....

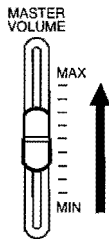

Initially set the [MASTER VOLUME] control about half way between the "MIN" and "MAX" settings. Then, when you start playing, re-adjust the [MASTER VOLUME] control for the most comfortable listening level.

## 3 Select a Voice .....

Select the desired voice by pressing one of the voice selectors. Use the [VARIATION] button to select a variation of the current voice, as required.

CLP-880

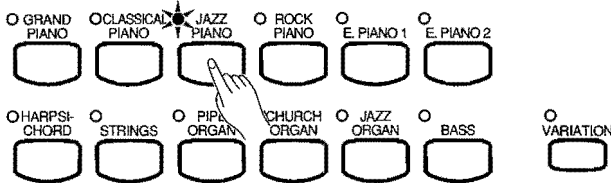

## 4 Play .....

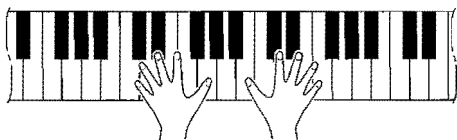

The Clavinova also offers keyboard touch response, so the volume and timbre of notes played can be controlled according to how "hard" you play the keys. The amount of variation available depends on the selected voice.

## 5 Add Effects As Required .....

BRILLIANCE

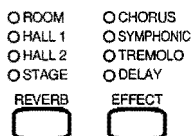
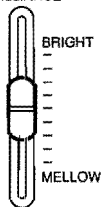

You can add or change reverb, effects (CLP-880/860/840) and brilliance (CLP-880/860/840) as desired by using the [REVERB] button (page 18), [EFFECT] button (page 19) and the [BRILLIANCE] control (page 19).

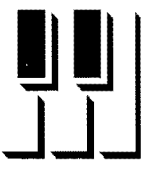

# Playing the Demonstration Tunes

Demonstration tunes are provided that effectively demonstrate each of the Clavinova's voices. There are also 50 piano songs that you can play individually, all in sequence, or in random order. Here's how you can select and play the demo tunes.



NOTE

- The demo or piano song mode cannot be engaged while the recorder (page 24) is in use.
- No MIDI reception occurs in the demo/piano song mode.
- The demo/piano song data is not transmitted via the MIDI connectors.

\* See page 41 for a complete listing of the demo tunes and piano songs.

## Voice Demo

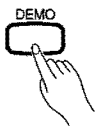

### 1 Engage the Demo Mode .....

Press the [DEMO] button to engage the demo mode — the voice selector indicators will flash in sequence.

### 2 Play a Voice Demo .....

Press one of the voice selectors to start playback of all songs starting from the corresponding voice demo tune — featuring the voice normally selected by that voice selector button. (If you press the [START/STOP] button instead of a voice selector button, the GRAND PIANO demo tune will begin playback.) The indicator of the selected voice selector button will flash during playback, and “- -” will appear on the LED display. You can start playback of any other voice demo tune during playback by simply pressing the corresponding voice selector. You can stop playback at any time by pressing the [START/STOP] button or the voice selector of the currently playing demo.

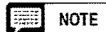

NOTE

- Use the [MASTER VOLUME] control to adjust the volume and the [BRILLIANCE] control (CLP-880/860/840) to adjust the brilliance (page 19).

### CLP-880

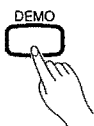
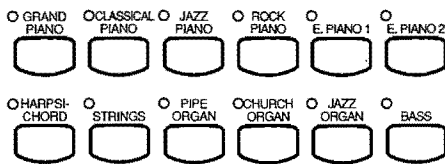

### 3 Exit From the Demo Mode .....

Press the [DEMO] button to exit from the demo mode and return to the normal play mode.

## Piano Song

### 1 Engage the Piano Song Mode .....

Press the [PIANO SONG] button to engage the piano song mode — the [PIANO SONG], [1] and [2] indicators will light.



### 2 Play a Piano Song .....

To play any of the 50 piano songs provided, use the [SONG SELECT ▼/▲] buttons to select the number of the tune you want to play (the number will appear on the LED display), then press the [START/STOP] button. Playback will stop automatically when playback of the selected piano song has finished.

Select “ALL” instead of a number to play all piano songs in sequence, or select “rand” to continuously play all piano songs in random order. Press the [START/STOP] button to stop playback.

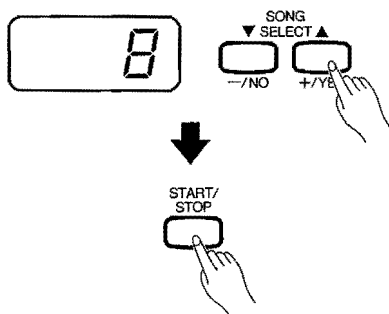

#### NOTE

- Use the [MASTER VOLUME] control to adjust the volume.
- You can use the [TEMPO ▼/▲] buttons to adjust the playback tempo as required. This produces a relative tempo variation, with a range from “-50” through “-” to “50” at maximum; the range will differ depending on the selected song.
- The default tempo “-” is automatically selected whenever a new piano song is selected, or playback of a new piano song begins during “ALL” or “rand” playback.
- You can play the keyboard along with the piano song playback. The voice playing on the keyboard can be changed.
- You can change the Brilliance control (CLP-880/860/840) and Reverb type that is applied to the voice you play on the keyboard and for the piano song playback. You can change the Effect type (CLP-880/860/840) and Touch sensitivity that is applied to the voice you play on the keyboard. When a new piano song is selected or a new piano song is automatically started in continuous play, the HALL 1 reverb type will automatically be selected.

### 3 Exit From the Piano Song Mode .....

Press the [PIANO SONG] button to exit from the piano song mode, the indicator will go off, and return to the normal play mode.



## Piano Song A-B Repeat

The A-B Repeat function can be used to continuously repeat a specified phrase within a piano song. Combined with the Part Cancel function described below, this provides an excellent way to practice difficult phrases.

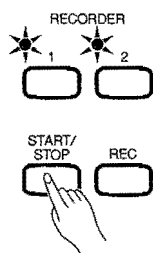
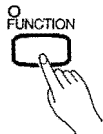
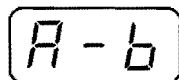
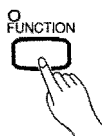
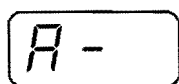

### 1 Specify the Beginning (A) of the Phrase.....

Select and play a piano song, then press the [FUNCTION] button at the beginning of the phrase you want to repeat. This sets the "A" point ("A-" will appear on the display).

To set the "A" point at the very beginning of the song, press the [FUNCTION] button before starting playback.

### 2 Specify the End (B) of the Phrase.....

Press the [FUNCTION] button a second time at the end of the phrase. This sets the "B" point ("A-b" will appear on the display). At this point repeat playback will begin between the specified A and B points.

### 3 Stop Playback.....

Press the [START/STOP] button to stop playback while retaining the specified A and B points. A-B repeat playback will resume if the [START/STOP] button is then pressed again.

To cancel the A and B points press the [FUNCTION] button once.



- The A and B points are automatically canceled when a new song is selected.
- The A-B Repeat function cannot be used during "RL L" or "r n d" playback.

## Piano Song Part Cancel

The 50 piano songs have separate left- and right-hand parts that can be turned on and off as required so you can practice the corresponding part on the keyboard. The right-hand part is played by the recorder's [1] track, and the left-hand part is played by recorder's [2] track. (Some of the songs are arrangements for four-hands, tracks [1] and [2] correspond to primo and secondo parts of the arrangement.)

### 1 Turn the Desired Part Off .....

Press the **RECORDER** [1] or [2] button to turn the corresponding part off — the corresponding indicator will go out (these buttons alternately toggle the corresponding part on and off).

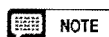

- The parts can be turned on or off even during playback.
- The Piano Song Part Cancel function cannot be used during "RL L" or "r-nd" playback.
- The "Piano Song Part Cancel Volume" function described on page 33 can be used to set the canceled part so that it plays at a volume from "0" (no sound) to "20". The default setting is "5".
- Both parts are automatically turned ON whenever a new song is selected.

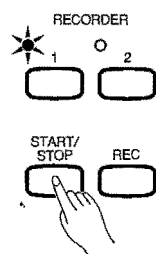
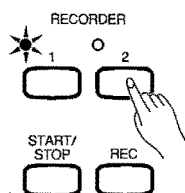

### 2 Start/Stop Playback .....

Press the [START/STOP] button to start and stop playback as required.

### ☐ Synchro Start .....

When the Synchro Start function is engaged, playback of the selected piano song will begin automatically as soon as you start playing on the keyboard.

To engage the Synchro Start function press the [START/STOP] button while holding the part button corresponding to the part which is ON. A dot will appear in the lower right corner of the display. (Repeat the previous operation to disengage the Synchro Start function.)

Playback will then start as soon as you begin playing on the keyboard.



- If you hold a track button which is OFF while pressing the [START/STOP] button, that track will be turned ON and the Synchro Start mode will be engaged.

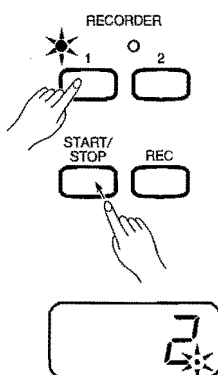

### ☐ Left Pedal Start/Stop .....

The left pedal can be assigned to start and stop piano song playback via the "Left Pedal Mode" function described on page 32.

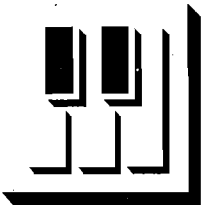

# The Dual Mode

The dual mode makes it possible to play two voices simultaneously across the entire range of the keyboard.

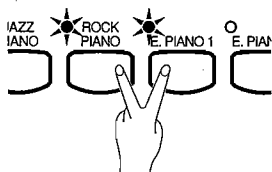

## Voice numbering priority

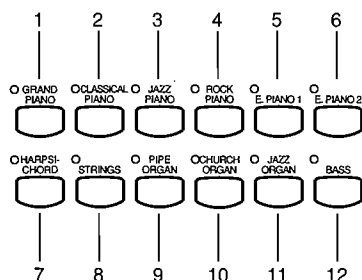

To activate the dual mode simply press two voice selectors at the same time (or press one voice selector while holding another). The voice indicators of both selected voices will light when the dual mode is active. To return to the normal single-voice play mode, press any single voice selector.

According to the voice numbering priority as shown in the diagram on the left, lower valued voice numbers will be designated as the 1st Voice (the other voice will be designated as the 2nd Voice).

The [STRINGS] [VARIATION] voice has a slow attack. This voice can sometimes be used with another voice in the Dual Mode to produce a better “blend”.

### NOTE

- The dual and split modes (CLP-880/860) cannot be engaged at the same time.
- The [VARIATION] button indicator will light if the variation is engaged for either or both of the dual-mode voices. While the dual mode is engaged the [VARIATION] button can be used to turn the variation for both voices on or off. To use the variation for only one of the voices the setting must be made prior to engaging the dual mode.
- **[EFFECT] in the Dual Mode**  
Depending upon the conditions one effect type will take priority over the other. Depth will be decided according to the depth default value of the voice combination. However, using function F3 (see page 29) you can change the depth value for each voice as you like.  
Effect depth setting via the panel controls (i.e. pressing the [-/NO] or [+ /YES] buttons while holding the [EFFECT] button — see page 19) will be applied to the 1st Voice only.
- **[REVERB] in the Dual Mode**  
The reverb type assigned to the 1st Voice will take priority over the other. (If the reverb is set to OFF, the 2nd Voice's reverb type will be in affect.)  
Reverb depth setting via the panel controls (i.e. pressing the [-/NO] or [+ /YES] buttons while holding the [REVERB] button — see page 18) will be applied to the 1st Voice only.

## Other Dual Mode Functions

The Clavinova Function mode provides access to a number of other dual-mode functions, listed below. See the corresponding pages for details.

- Dual Balance ..... 29
- Dual Detune ..... 29
- 1st Voice Octave Shift ..... 29
- 2nd Voice Octave Shift ..... 29
- 1st Voice Effect Depth ..... 30
- 2nd Voice Effect Depth ..... 30
- Reset ..... 30





# The Split Mode (CLP-880/860)

The split mode makes it possible to play two different voices on the keyboard — one with the left hand and another with the right hand. The Left Voice is played on all keys to the left of (and including) a specified “split point” key, while the Right Voice is played on all keys to the right of the split point key.

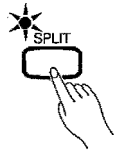

To activate the split mode simply press the [SPLIT] button so that its indicator lights. The split mode can be turned off at any time by pressing the [SPLIT] button again so that its indicator goes out.



**NOTE** • The dual and split modes cannot be engaged at the same time.

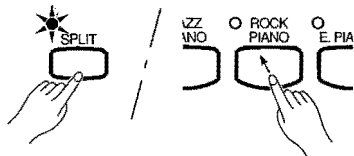

## Selecting the Right and Left Voices

The voice that was selected before the split mode was engaged becomes the Right Voice in the split mode. (The Right Voice can also be changed while in the split mode, by simply pressing the corresponding voice selector.)

To select a Left Voice press the corresponding voice selector while holding the [SPLIT] button (default: [BASS]). The indicator of the Left Voice selector will light while the [SPLIT] button is pressed, then only the Right Voice selector and [SPLIT] button indicators will remain lit.



**NOTE** • The variation can be individually turned on and off for the split mode voices. Normally the voice indicator of the Right Voice lights in the split mode. The [VARIATION] can be used to turn the variation for the Right Voice on or off as required. While the [SPLIT] button is held, however, the voice indicator of the Left Voice lights, and in this state the [VARIATION] button can be used to turn the variation for the Left Voice on or off as required.

### • [EFFECT] in the Split Mode

Depending upon the conditions, one effect type will take priority over the other. Depth will be decided according to the depth default value of the voice combination. However, using function F4 (see page 30) you can change the depth value for each voice as you like.

Effect depth setting via the panel controls (i.e. pressing the [-/NO] or [+ /YES] buttons while holding the [EFFECT] button — see page 19) will be applied to the Right Voice only.

### • [REVERB] in the Split Mode

The reverb type assigned to the Right Voice will take priority over the other. (If the reverb is set to OFF, the Left Voice's reverb type will be in affect.)

Reverb depth setting via the panel controls (i.e. pressing the [-/NO] or [+ /YES] buttons while holding the [REVERB] button — see page 18) will be applied to the Right Voice only.

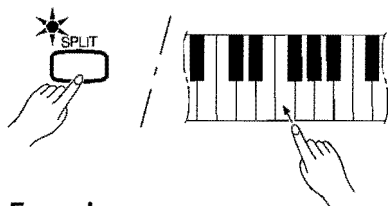

**Example:**

R-1	b-1	C2	F#2
A-1	Bb-1	C2	F#2

- “b” is indicated with a lower “-”.
- “#” is indicated with an upper “#”.

## Setting the Split Point

The split point is initially set at the F#2 key by default. You can change the split point to any other key by pressing the key while holding the [SPLIT] button (the name of the current split-point key appears on the LED display while the [SPLIT] button is held). The split point can also be set via the Function mode (see below).

## Other Split Mode Functions

The Clavinova Function mode provides access to a number of other split-mode functions, listed below. See the corresponding pages for details.

- Split Point ..... 30
- Split Balance ..... 30
- Right Voice Octave Shift ..... 31
- Left Voice Octave Shift ..... 31
- Right Voice Effect Depth ..... 31
- Left Voice Effect Depth ..... 31



# Reverb

The **[REVERB]** button selects a number of digital reverb effects that you can use for extra depth and expressive power.

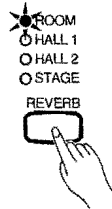

To select a reverb type press the **[REVERB]** button a few times until the indicator corresponding to the desired type lights (the indicators light in sequence each time the **[REVERB]** button is pressed). No reverb is produced when all indicators are off.

## OFF

No reverb effect is selected when no REVERB indicator is lit.

## ROOM

This setting add a continuous reverb effect to the sound that is similar to the type of acoustic reverberation you would hear in a room.

## HALL 1

For a "bigger" reverb sound, use the HALL 1 setting. This effect simulates the natural reverberation of a small-size concert hall.

## HALL 2

For a really spacious reverb sound, use the HALL 2 setting. This effect simulates the natural reverberation of a large concert hall.

## STAGE

A simulation of the type of reverb produced in a stage environment.



NOTE

The default reverb type (including OFF) and depth settings are different for each voice.

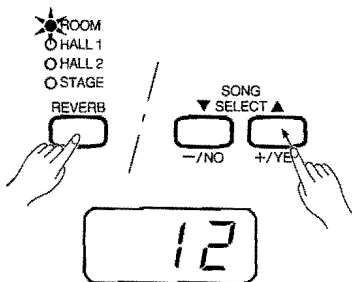

## Adjusting Reverb Depth .....

Adjust the reverb depth for the selected voice by using the **[-/NO]** and **[+/YES]** buttons while holding the **[REVERB]** button. The depth range is from 0 through 20 (the current depth setting appears on the LED display while the **[REVERB]** button is held). A setting of "0" produces no effect, while a setting of "20" produces maximum reverb depth. Press the **[-/NO]** and **[+/YES]** buttons simultaneously while holding the **[REVERB]** button to recall the default setting for the current voice (default depth settings are different for each voice).



# The Effect (CLP-880/860/840)

The [EFFECT] button allows you to select one of the effects that can give your sound greater depth and animation.



To select an effect type press the [EFFECT] button a few times until the indicator corresponding to the desired type lights (the indicators light in sequence each time the [EFFECT] button is pressed). No effect is produced when all indicators are off.

### OFF

No effect is selected when no EFFECT indicator is lit.

### CHORUS

Shimmering, broadening effect

### SYMPHONIC

Adds a deep, symphonic backdrop

### TREMOLO

Tremolo effect

### DELAY

Echo effect



*The default effect type (including OFF) and depth settings are different for each voice.*

## Adjusting Effect Depth

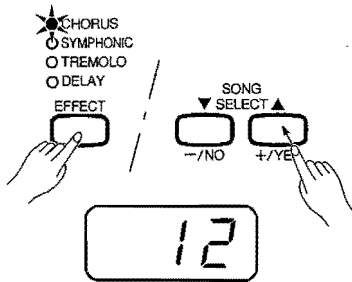

Effect depth can be individually adjusted for the selected voice by using the [-/NO] and [+ /YES] buttons while holding the [EFFECT] button. The depth range is from 0 through 20 (the current depth setting appears on the LED display while the [EFFECT] button is held). A setting of "0" produces no effect, while a setting of "20" produces maximum effect depth. Press the [-/NO] and [+ /YES] buttons simultaneously while holding the [EFFECT] button to recall the default setting for the current voice (the default depth settings are different for each voice).

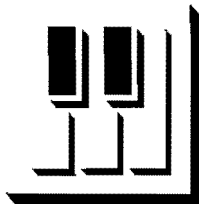

# Brilliance (CLP-880/860/840)

This control can be used to change the tonality or "timbre" of the sound output. The control range is from MELLOW to BRIGHT.

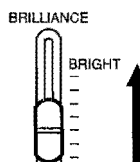

For a brighter or "sharper" tone, slide the control towards the BRIGHT position. For a "rounder" more mellow tone, slide the control towards the MELLOW position.



*When the BRILLIANCE is set BRIGHT the overall sound will be*

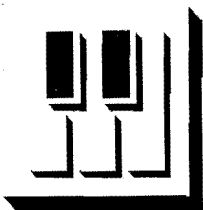

# The Pedals

The CLP-820S has two and other models have three foot pedals that produce a range of expressive effects similar to those produced by the pedals on an acoustic piano.

CLP-880/860/840/820

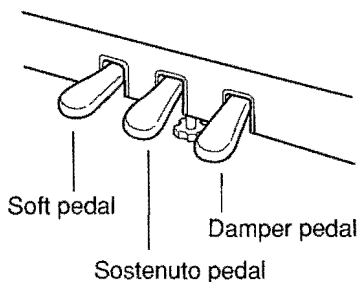

CLP-820S

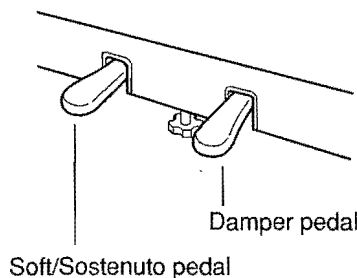

## Damper (Right) Pedal .....

The damper pedal functions in the same way as a damper pedal on an acoustic piano. When the damper pedal is pressed notes played have a long sustain. Releasing the pedal immediately stops (damps) any sustained notes.

On the CLP-880/860, when GRAND PIANO, CLASSICAL PIANO, or JAZZ PIANO is selected the damper pedal also produces a special “resonance” that simulates the ring of the strings and the sound board of an acoustic piano.

The CLP-880/860 damper pedal additionally features continuous damping. This allows you to create shorter effects by pressing the damper pedal down only part of the way.

**NOTE** • On the CLP-880/860, soundboard depth and damper pedal mode (switch/continuous) settings can be changed using the “Pedal Functions” (page 32) in the function mode.

## Sostenuto (Center) Pedal (except for CLP-820S) .....

If you play a note or chord on the keyboard and press the sostenuto pedal while the note(s) are held, those notes will be sustained as long as the pedal is held (as if the damper pedal had been pressed) but all subsequently played notes will not be sustained. This makes it possible to sustain a chord, for example, while other notes are played “staccato.”

**NOTE** • Organ and string voices will continue to sound for as long as the sostenuto pedal is depressed.

## Soft (Left) Pedal .....

The soft pedal reduces the volume and slightly changes the timbre of notes played while the pedal is pressed. The soft pedal will not affect notes which are already playing when it is pressed.

The left pedal can also be assigned to song start/stop operation (or sostenuto in the case of the CLP-820S) via the “Left Pedal Mode” described on page 32.

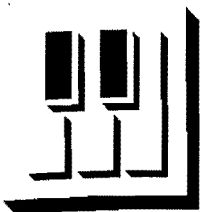

# Touch Sensitivity

Four different types of keyboard touch sensitivity — HARD, MEDIUM, SOFT or FIXED — can be selected to match different playing styles and preferences.

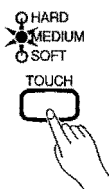

To select a touch sensitivity type press the [TOUCH] button a few times until the indicator corresponding to the desired type lights (the indicators light in sequence each time the [TOUCH] button is pressed).

## HARD

The HARD setting requires the keys to be played quite hard to produce maximum loudness.

## MEDIUM

The MEDIUM setting produces a fairly “standard” keyboard response. This is the initial factory default setting.

## SOFT

The SOFT setting allows maximum loudness to be produced with relatively light key pressure.

## FIXED (no indicator lit)

All notes are produced at the same volume no matter how hard the keyboard is played.

When the FIXED type is selected, the volume of notes played in the FIXED mode can be set by using the [-/NO] and [+ /YES] buttons while the [TOUCH] button is held (the current volume level appears on the display). The volume range is from 1 through 127. The default setting is 64.



NOTE

- This setting does not change the weight of the keyboard.
- The touch sensitivity type and volume set in the FIXED mode will become the common setting for all voices.

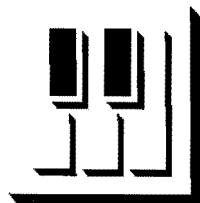

# Transposition

The Clavinova’s TRANSPOSE function makes it possible to shift the pitch of the entire keyboard up or down in semitone intervals up to a maximum of 12 semitones (i.e. a maximum of one octave up or down). “Transposing” the pitch of the Clavinova keyboard facilitates playing in difficult key signatures, and you can easily match the pitch of the keyboard to the range of a singer or other instrumentalist.

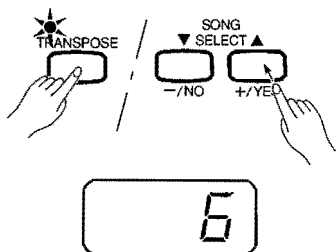

Use the [-/NO] or [+ /YES] button while holding the [TRANSPOSE] button to transpose down or up as required. The transposition range is from “-12” (down one octave) through “0” (normal pitch) to “12” (up one octave). The amount of transposition appears on the LED display while the [TRANSPOSE] button is held. The default transposition setting is “0”.



NOTE

- The [TRANSPOSE] button indicator remains lit when a transposition other than “0” is selected.

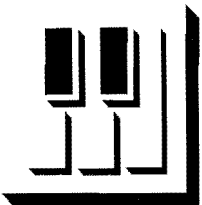

# Tuning

Tuning makes it possible to adjust the pitch of the Clavinova over a 427.0 Hz ... 453.0 Hz (corresponding to the A3 note's Hz) range in approximately 0.2 Hertz intervals. Pitch control is useful for tuning the Clavinova to match other instruments or recorded music.

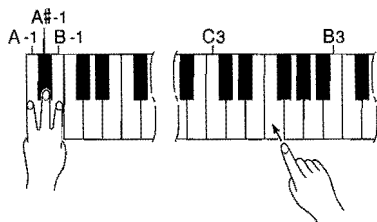
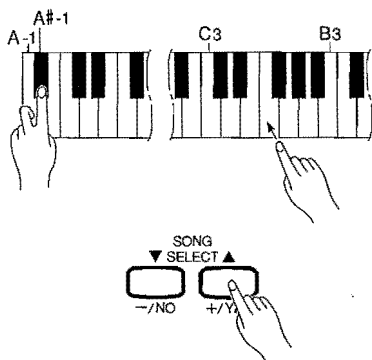
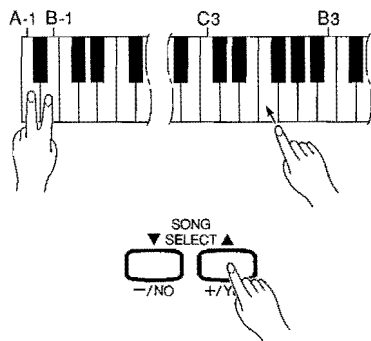

## Tuning Up

- 1** To tune up (raise pitch), hold the A-1 and B-1 keys simultaneously.
- 2** Press any key between C3 and B3. Each time a key in this range is pressed the pitch is increased by approximately 0.2 Hz. The [-/NO] and [+ /YES] buttons can also be used to tune down or up, respectively, in approximately 1 Hz increments. Press the [-/NO] and [+ /YES] buttons simultaneously to recall standard tuning (A3 = 440 Hz).
- 3** Release the A-1 and B-1 keys.

## Tuning Down

- 1** To tune down (lower pitch), hold the A-1 and A#-1 keys simultaneously.
- 2** Press any key between C3 and B3. Each time a key in this range is pressed the pitch is decreased by approximately 0.2 Hz. The [-/NO] and [+ /YES] buttons can also be used to tune down or up, respectively, in approximately 1 Hz increments. Press the [-/NO] and [+ /YES] buttons simultaneously to recall standard tuning (A3 = 440 Hz).
- 3** Release the A-1 and A#-1 keys.

## To Restore Standard Pitch

- 1** To restore the default pitch (A3 = 440 Hz), hold the A-1, A#-1 and B-1 keys simultaneously.
- 2** Press any key between C3 and B3.
- 3** Release the A-1, A#-1 and B-1 keys.

In terms of "Hertz", the overall tuning range is from 427.0 Hz to 453.0 Hz. The current tuning setting is shown on the LED display while the tuning is being adjusted. Tenths of a Hertz are indicated on the LED display by the appearance and position of one or two dots, as in the following example:

Display	Value
440	440.0
440	440.2
440	440.4
440	440.6
440	440.8

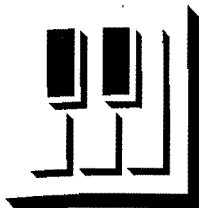

# The Metronome & Tempo Control

The Clavinova built-in metronome is a convenient feature for practice, and it can also provide a solid rhythmic guide when recording using the Recorder feature, described in the next section.

## The Metronome



The metronome sound is alternately turned on and off by pressing the [METRONOME] button. When on, the beat indicator flashes at the current tempo.

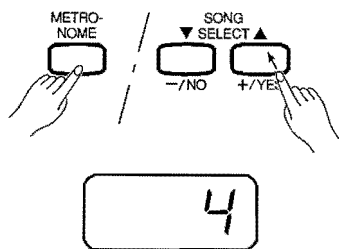

### Metronome Time Signature .....

The time signature (beat) of the metronome can be set by using the [-/NO] and [+ /YES] buttons while holding the [METRONOME] button. You can set the beat to 0, 2, 3, 4 or 6 (the current setting appears on the LED display while the [METRONOME] button is held). Press the [-/NO] and [+ /YES] buttons simultaneously while holding the [METRONOME] button to recall the default setting "0" (no accent).

### Metronome Volume Function .....

The volume of the metronome sound can be adjusted via the Metronome Volume function in the Function mode—page 33.

## Tempo Control

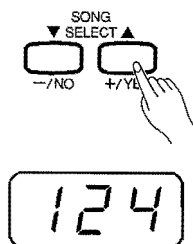

The tempo of the metronome and recorder playback (the recorder is described in the next section) can be set from 32 to 280 beats per minute by using the [TEMPO ▼/▲] buttons. The selected tempo will appear on the LED display while in the normal play mode and while the [TEMPO ▼/▲] buttons are being used to adjust the tempo in the recording/playback mode. The default tempo (120 or the recorded song tempo when the recorder contains data and the playback track indicator is lit) can be recalled by simultaneously pressing the [▼] and [▲] buttons.

# Using the Recorder

The Clavinova features a two-track recorder that let you record what you play on the keyboard and then play it back. Two tracks mean that you can “overdub” one part on top of another, using a different voice if you like. The recorder feature is a useful adjunct to any keyboard study program, since it lets you hear exactly how you sound from the listener’s perspective. It can also be just plain fun.

The recorder actually records the following data:

- Entire Song
  - Tempo ● Time signature (beat) ● Reverb type (including OFF)
  - Effect type (CLP-880/860/840)
- Individual Tracks
  - Notes played ● Voice selection ● Voice variation
  - Dual mode voices ● Split mode voices (CLP-880/860)
  - Damper pedal ● Soft pedal
  - Sostenuto pedal (not recorded as an initial setting)
  - Effect depth (CLP-880/860/840) ● Reverb depth
  - Dual balance (F3) ● Dual detune (F3) ● Dual octave shift (F3)
  - Split balance (F4: CLP-880/860) ● Split octave shift (F4: CLP-880/860)

## Recording

### 1] Make All Necessary Initial Settings .....



Before actually beginning to record, select the voice you want to record with (or voices if you will be using the dual or split mode). You might also want to set the volume and tempo controls.

### 2] Engage the Record Ready Mode .....

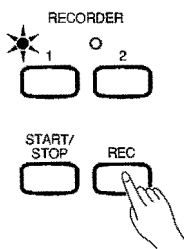

Press the **RECORDER [REC]** button to engage the record ready mode (recording does not actually start yet). The record ready mode can be disengaged before recording by pressing the **[REC]** button a second time.



*The record ready mode cannot be engaged while the demo/piano song mode is engaged.*

### 3] Select the Record Track .....

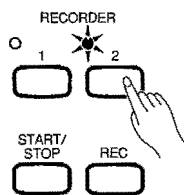

When the record mode is engaged in the previous step, the last-recorded track will automatically be selected for recording and its indicator — i.e. the **[1]** or **[2]** button indicator — will glow red. If you want to record on a different track, press the appropriate track button so that its indicator glows red.



- The track button indicators of tracks which contain previously recorded data will glow green (unless the track is turned off as described below). The previously-recorded data on the non-record track will normally be played back as you record, so you can play along with a previously-recorded track. If you don't want to hear the previously recorded track as you record (when you want to record a song different from what you recorded on the previous track etc.), press the playback track button before pressing the [REC] button (step 1, above) so that its indicator goes out.*
- Recording on a track which already contains data will erase all previous data on that track.*
- When the record mode is engaged the amount of memory available for recording will be shown on the LED display in approximate kilobytes (starting at "50" on the CLP-880/860 and "25" on the CLP-840/820/820S).*

CLP-880/860

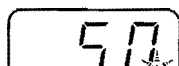



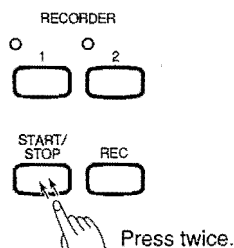
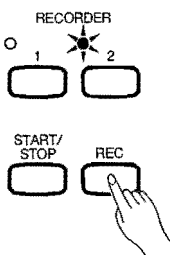
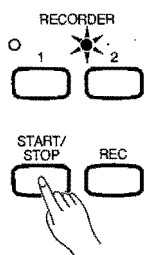
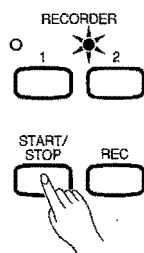

## 4 Start Recording .....

Recording will begin automatically as soon as you play a note on the keyboard or press the [START/STOP] button. The current measure number will appear on the display while recording.



- The left pedal can be assigned to start and stop recording via the "Left Pedal Mode" function described on page 32.
- If the metronome was on when you started recording, you'll be able to keep time with the metronome while recording, but the metronome sound will not be recorded.
- You can record up to a maximum of about 10,000 notes on the CLP-880/860 or 5,000 notes on the CLP-840/820/820S, depending on pedal usage and other factors. The record track indicator will begin to flash when recorder memory is almost full. If the memory becomes full during recording, "FUL" will appear on the display and recording will stop automatically. (All recorded data up to that point will be retained.)

## 5 Stop Recording .....

Press either the RECORDER [REC] or [START/STOP] button to stop recording.

The indicator of the recorded track will glow green to indicate that it now contains data.

## Changing the Initial Settings .....

The initial voice, tempo, reverb type, reverb depth, and effect settings made in step 1 of the recording procedure are actually recorded by the Clavinova.

These initial settings can be changed after the recording is finished by pressing the [REC] button to engage the record ready mode, pressing the appropriate track button, making the required changes, and then pressing the [REC] button again to exit from the record ready mode and register the changes.

If you do this, be careful not to press the [START/STOP] button or a key on the keyboard, either of which will start recording and erase all previous recorded data on the selected track.

It is possible to cancel the operation even after changes have been made: change tracks and then press the [REC] button to exit from the record mode (this also cancels data for the entire song).



- The following data for initial settings cannot be changed: "Dual balance (F3)", "Dual detune (F3)", "Dual octave shift (F3)", "Split balance (F4:CLP-880/860)" or "Split octave shift (F4:CLP-880/860)".

## Erasing a Single Track .....

All data can be erased from either of the recorder's tracks by engaging the record mode, selecting the track you want to erase, and then pressing the [START/STOP] button twice without recording any data.

## Playback

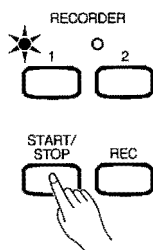

To play back what you've recorded, first make sure that the green track indicators of the tracks you want to play are lit. If not, press the corresponding track button(s) so that they are lit. Then press the RECORDER [START/STOP] button. Playback starts from the beginning of the recorded data, and will stop automatically at the end of the recorded data. You can also stop playback at any time by pressing the [START/STOP] button.

To mute a track so that it doesn't play back, press the corresponding track button so that its indicator goes out (press again to turn the track back on).

The current measure number appears on the display during playback.

### NOTE

- It is possible to play along on the keyboard during playback. In this case, the playback voice and the voice you play on the keyboard are not the same. The playback voice is the voice that was set when the data was recorded. The voice you play on the keyboard is the voice that is selected on the panel.
- The playback volume and tempo can be adjusted by using the [MASTER VOLUME] control and [TEMPO ▼/▲] buttons (press both [TEMPO ▼/▲] buttons simultaneously to recall the default tempo).
- All recorder data will be retained in memory for about one week after the power is turned off. If you want to keep your recorded data for longer periods, turn the power on for a few minutes at least once a week. It is also possible to store it to an external MIDI storage device such as the Yamaha MIDI Data Filer MDF3 by using the Bulk Data Dump function described on page 36.
- The track indicators will not light automatically when the power is turned on even if the recorder contains data. It is therefore necessary to press the track buttons so that the corresponding green indicators light before starting RECORDER playback. It is also a good idea to press the track buttons to check if the tracks contain data before recording. If the green indicator lights when the corresponding track button is pressed, that track contains data which will be erased and replaced by the newly-recorded data.
- If the metronome is being used during playback, the metronome will automatically stop when playback is stopped.
- During recorder playback, the volume of a track which is turned off will always be "0" (i.e. the "Piano Song Part Cancel Volume" function — page 33 — only affects piano song playback).
- The playback data is not transmitted via the MIDI OUT connector.
- Playback cannot be started when the demo/piano song mode is engaged.
- Playback cannot be started when the recorder contains no data, or when both track buttons are off.
- When using REVERB or EFFECT during playback, depending upon the conditions one reverb type and one effect type will take priority.

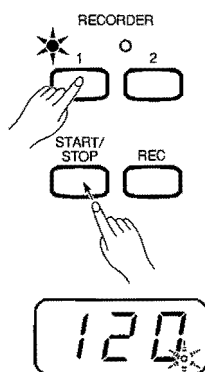

### Synchro Start

When the Synchro Start function is engaged, recorder playback will begin automatically as soon as you start playing on the keyboard.

To engage the Synchro Start function press the [START/STOP] button while holding a track button which is ON. The rightmost dot on the display will flash at the current tempo. (Repeat the previous operation to disengage the Synchro Start function.) Playback will then start as soon as you begin playing on the keyboard.

If you hold a track button which is OFF while pressing the [START/STOP] button, that track will be turned ON and the Synchro Start mode will be engaged.

### Left Pedal Start/Stop

The left pedal can be assigned to start and stop recorder playback via the



# The Function Mode

The [FUNCTION] button provides access to a range of functions that give the Clavinova extraordinary versatility. The functions are categorized in groups as follows:

CLP-840/ 820/820S	CLP-880/ 860		
F1	F1	Tuning .....	28
F2	F2	Scale .....	28
F3	F3	Dual Mode Functions .....	29
—	F4	Split Mode Functions .....	30
F4	—	Left Pedal Mode .....	32
—	F5	Pedal Functions .....	32
F5	F6	Metronome Volume .....	33
F6	F7	Piano Song Part Cancel Volume .....	33
F7	F8	MIDI Functions .....	34
F8	F9	Backup Functions .....	37

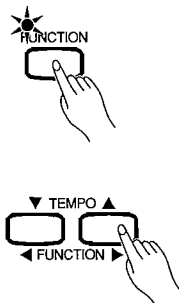

## ● Operation Example

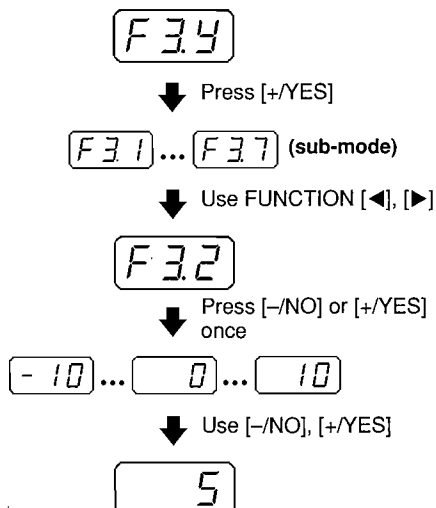

## □ To Select a Function ...

**1** Press the [FUNCTION] button so that its indicator lights.

**NOTE** • Functions cannot be selected during demo/piano song playback or when the recorder is in operation.

**2** Use the FUNCTION [◀] and [▶] buttons to select the desired function: F1 through F8 on the CLP-840/820/820S; F1 through F9 on the CLP-880/860.

**3** In the case of the Scale (F2), Dual Mode (F3), Split Mode (F4: CLP-880/860), Pedal Functions (F5: CLP-880/860), MIDI (F7: CLP-840/820/820S, F8: CLP-880/860), and Backup (F8: CLP-840/820/820S, F9: CLP-880/860) functions, you will have to press the [+ / YES] button once to enter the respective sub-mode after the function has been selected, and then use the FUNCTION [◀] and [▶] buttons again to select the desired sub-function.

**NOTE** • The Dual or Split (CLP-880/860) mode must be engaged before the F3 and F4 functions can be selected, respectively. If the corresponding mode is not engaged, "F3-" or "F4-" will appear on the display and the corresponding sub-mode will not be available.

• The Dual mode can be engaged while in the Function mode, but the Function mode must be exited before the Split mode (CLP-880/860) can be engaged.

**4** Set the function as required by using the [- / NO] and [+ / YES] buttons (see the individual function descriptions, below).

**NOTE** • After selecting the function, the current setting will be displayed when the [- / NO] or [+ / YES] button is pressed for the first time.

**5** Press the [FUNCTION] button so that its indicator goes out to exit from the function mode.

# The Function Mode

## F1 Tuning

In addition to the tuning method described on page 22, overall tuning can also be accomplished via the F1 function.

After selecting "F1", use the [-/NO] and [+ /YES] buttons to lower or raise the pitch in approximately 0.2 Hz increments (the first time the [-/NO] or [+ /YES] button is pressed simply switches to the tuning value display without actually changing the tuning). The overall tuning range is from 427.0 Hz to 453.0 Hz (corresponding to the A3 note's Hz). Press the [-/NO] and [+ /YES] buttons simultaneously to recall the default value "440 Hz".

Tenths of a Hertz are indicated on the LED display by the appearance and position of one or two dots, as in the following example:

Display	Value
440	440.0
440.	440.2
440.	440.4
440.	440.6
440.	440.8

## F2 Scale

After selecting "F2", press the [+ /YES] button to engage the scale function sub-mode, then use the FUNCTION [◀] and [▶] buttons to select the desired scale function, as listed below.

### F2.1: Scale

In addition to the standard Equal Temperament tuning, the Clavinova includes 6 classic tunings that you can select and use to play music of the corresponding period, or experiment with in a more modern context. The tunings are:

- |                      |                 |
|----------------------|-----------------|
| 1: Equal Temperament | 5: Mean Tone    |
| 2: Pure Major        | 6: Werckmeister |
| 3: Pure Minor        | 7: Kirnberger   |
| 4: Pythagorean       |                 |

Use the [-/NO] and [+ /YES] buttons to select the number of the desired tuning. Press the [-/NO] and [+ /YES] buttons simultaneously to recall the default settings (Equal Temperament tuning).

### F2.2: Base Note

Unlike Equal Temperament tuning, these classic tunings must be tuned to a specific key. Use the [-/NO] and [+ /YES] buttons to select the key you want the previously selected tuning to be based. The selected key will appear on the display, followed by a low bar if flat (e.g. "B<sub>♭</sub>") or a high bar if sharp (e.g. "F<sub>♯</sub>").

Press the [-/NO] and [+ /YES] buttons simultaneously to recall the default settings "C".

## F3 Dual Mode Functions

After selecting “F 3.4”, press the [+ / YES] button to engage the dual-mode function sub-mode, then use the FUNCTION [◀] and [▶] buttons to select the desired dual mode function, as listed below.

If the Dual mode is not engaged “F 3.-” will appear instead of “F 3.4” and the Dual mode functions cannot be selected. If this happens engage the Dual mode and proceed.

■ **SHORTCUT:** You can jump directly to the dual-mode functions (F3) by pressing the [FUNCTION] button while holding the two dual-mode voice selectors.



NOTE

• Dual mode function settings are set individually for each voice combination.

### F3.1: Dual Balance

The volume levels of the two voices combined in the dual mode can be adjusted as required by using this function. Use the [- / NO] and [+ / YES] buttons to adjust the balance as required. The balance range is from 0 through 20. A setting of “10” produces equal balance between the two dual-mode voices. Settings below “10” increase the volume of the 2nd Voice in relation to the 1st Voice, and settings above “10” increase the volume of the 1st Voice in relation to the 2nd Voice (“1st” and “2nd” is explained on page 16). Press the [- / NO] and [+ / YES] buttons simultaneously to recall the default setting (different for each voice combination).

You can set one voice as the main voice, and another voice as a softer, mixed voice.

### F3.2: Dual Detune

This function makes it possible to detune the 1st and 2nd dual-mode Voices to create a thicker sound. Use the [- / NO] and [+ / YES] buttons to set the amount of detuning as required. The detune range is from -10 through 10. A setting of “0” sets both voices to the same pitch. Settings below “0” increase the pitch of the 2nd Voice in relation to the 1st Voice, and settings above “0” increase the pitch of the 1st Voice in relation to the 2nd Voice (“1st” and “2nd” is explained on page 16). Press the [- / NO] and [+ / YES] buttons simultaneously to recall the default setting (different for each voice combination).

### F3.3: 1st Voice Octave Shift

### F3.4: 2nd Voice Octave Shift

Depending on which voices you combine using the dual mode, the combination may sound better if one of the voices is shifted up or down an octave. Use the [- / NO] and [+ / YES] buttons to set the octave of the 1st or 2nd Voice as required (“1st” and “2nd” is explained on page 16). The available settings are “0” for normal pitch, “-1” to shift the pitch down one octave, and “1” to shift the pitch up one octave. Press the [- / NO] and [+ / YES] buttons simultaneously to recall the default setting (different for each voice combination).

## The Function Mode

- F3.5: 1st Voice Effect Depth (CLP-880/860/840)** .....
- F3.6: 2nd Voice Effect Depth (CLP-880/860/840)** .....

These functions make it possible to individually set the depth of the effect for the 1st and 2nd dual-mode Voices (“1st” and “2nd” is explained on page 16). Use the [–/NO] and [+ /YES] buttons to set the effect depth for the corresponding voice as required. The depth range is from 0 through 20. A setting of “0” produces no effect, while a setting of “20” produces maximum effect depth. Press the [–/NO] and [+ /YES] buttons simultaneously to recall the default setting (different for each voice combination).

 **NOTE** • The effect depth settings cannot be changed unless the EFFECT is ON. The Function mode must be exited before EFFECT can be turned ON.

- F3.5: Reset (CLP-820/820S)** .....
- F3.7: Reset (CLP-880/860/840)** .....

This function resets all dual-mode functions to their default values. Press the [+ /YES] button to reset the values. “Er d” will appear on the display when all functions have been reset.

## F4 CLP-880/860 Split Mode Functions

After selecting “F 4.4”, press the [+ /YES] button to engage the split-mode function sub-mode, then use the FUNCTION [◀] and [▶] buttons to select the desired split mode function, as listed below.

If the Split mode is not engaged “F 4.-” will appear instead of “F 4.4” and the Split mode functions cannot be selected. Also note that you must exit from the Function mode before the Split mode can be engaged.

■ **SHORTCUT:** You can jump directly to the split-mode functions (F4) by pressing the [FUNCTION] button while holding the [SPLIT] button.

 **NOTE** • Split mode function settings are set individually for each voice combination.

- F4.1: Split Point** .....

In addition to the split point setting method described on page 17, the split point can be set via this function. Use the [–/NO] and [+ /YES] buttons to set the split point as required, or simply press the appropriate key on the keyboard: from “A-1” to “C7”. Press the [–/NO] and [+ /YES] buttons simultaneously to recall the default setting “F#2”.

- F4.2: Split Balance** .....

The volume levels of the two voices combined in the split mode can be adjusted as required by using this function. Use the [–/NO] and [+ /YES] buttons to adjust the balance as required. The balance range is from 0 through 20. A setting of “10” produces equal balance between the two split-mode voices. Settings below “10” increase the volume of the Left Voice in relation to the Right Voice, and settings above “10” increase the volume of the Right Voice

## F4.3: Right Voice Octave Shift .....

## F4.4: Left Voice Octave Shift .....

Depending on which voices you combine using the split mode, the combination may sound better if one of the voices is shifted up or down an octave. Use the [-/NO] and [+ /YES] buttons to set the octave of the Left or Right Voice as required. The available settings are “0” for normal pitch, “-1” to shift the pitch down one octave, and “1” to shift the pitch up one octave. Press the [-/NO] and [+ /YES] buttons simultaneously to recall the default setting (different for each voice combination).

Set according to the pitch extent for the song you want to play.

## F4.5: Right Voice Effect Depth .....

## F4.6: Left Voice Effect Depth .....

These functions make it possible to individually set the depth of the effect for the Left and Right split-mode Voices. Use the [-/NO] and [+ /YES] buttons to set the effect depth for the corresponding voice as required. The depth range is from 0 through 20. A setting of “0” produces no effect, while a setting of “20” produces maximum effect depth. Press the [-/NO] and [+ /YES] buttons simultaneously to recall the default setting (different for each voice combination).

 **NOTE** • The effect depth settings cannot be changed unless the EFFECT is ON. The Function mode must be exited before EFFECT can be turned ON.

## F4.7: Damper Range .....

The Damper Range function determines whether the damper pedal affects the Right Voice, the Left Voice, or both the Left and Right Voices in the split mode. Use the [-/NO] and [+ /YES] buttons to select “2” for the Left Voice, “1” for the Right Voice, or “ALL” for both voices. Press the [-/NO] and [+ /YES] buttons simultaneously to recall the default setting “ALL”.

## F4.8: Reset .....

This function resets all split-mode functions to their default values. Press the [+ /YES] button to reset the values. “E n d” will appear on the display when all functions have been reset.

## The Function Mode

### **F4** CLP-840/820/820S Left Pedal Mode

This function sets the left pedal for normal soft-pedal operation, for song start/stop operation, or for sostenuto (CLP-820S only) operation. Use the [–/NO] and [+ /YES] buttons to select the desired left-pedal mode. “1” is the normal soft-pedal mode, “2” is the start/stop mode, and “3” is the sostenuto mode (CLP-820S only). When the start/stop mode is selected, the left pedal functions in the same way as the panel [START/STOP] button. Press the [–/NO] and [+ /YES] buttons simultaneously to recall the default setting “1”.

### **F5** CLP-880/860 Pedal Functions

After selecting “F 5.4”, press the [+ /YES] button to engage the pedal functions sub-mode, then use the FUNCTION [◀] and [▶] buttons to select the desired pedal functions, as listed below.

#### F5.1: Left Pedal Mode

This function conveniently lets you set the left pedal for normal soft pedal operation, or for song start/stop operation. Use the [–/NO] and [+ /YES] buttons to select the desired left-pedal mode. Press the [–/NO] and [+ /YES] buttons simultaneously to recall the default setting “1”.

- |               |   |
|---------------|---|
| 1: Soft       | The left pedal functions as the soft pedal.                             |
| 2: Start/Stop | The left pedal functions in the same manner as the [START/STOP] button. |

#### F5.2: Damper Mode

This function lets you set how the damper pedal affects the sustain sound. There are two modes for pedal operation.

- |               |  |
|---------------|--|
| 1: Switch     | In this mode the pedal acts as a simple on/off switch for sustain.   |
| 2: Continuous | In this mode the pedal continuously changes the amount of sustain (in eight-step gradations) i.e., the further down you press the pedal the longer the sound sustains. |

Use the [–/NO] and [+ /YES] buttons to select the desired damper mode. Press the [–/NO] and [+ /YES] buttons simultaneously to recall the default setting “2”.

#### F5.3: Soundboard Depth

Certain piano voices (GRAND PIANO, CLASSICAL PIANO, and JAZZ PIANO) feature a special effect which recreates the ring of the strings and the soundboard resonance of an actual acoustic piano when the damper pedal is pressed. This function lets you adjust the depth of this effect. Use the [–/NO] and [+ /YES] buttons to set the effect depth as required. The effect depth range is from 0 through 20. A setting of “0” produces no effect, while a setting of “20” produces maximum effect depth. Press the [–/NO] and [+ /YES] buttons simultaneously to recall the default setting “12”.



**F5** CLP-840/820/820S Metronome Volume \_\_\_\_\_

**F6** CLP-880/860 Metronome Volume \_\_\_\_\_

■ **SHORTCUT:** You can jump directly to the metronome functions by pressing the **[FUNCTION]** button while holding the **[METRONOME]** button.

The volume of the metronome sound can be changed. After selecting “F5” or “F6”, use the **[-/NO]** and **[+/YES]** buttons to set the metronome volume as required. The volume range is from 1 through 20. A setting of “1” produces minimum sound, while a setting of “20” produces maximum metronome volume. Press the **[-/NO]** and **[+/YES]** buttons simultaneously to recall the default setting “10”.

**F6** CLP-840/820/820S Piano Song Part Cancel Volume \_\_\_\_\_

**F7** CLP-880/860 Piano Song Part Cancel Volume \_\_\_\_\_

This function sets the volume at which a “canceled” part is played during piano song playback (see page 15 for information on the “part-cancel” function). Use the **[-/NO]** and **[+/YES]** buttons to set the volume as required. The volume range is from 0 through 20. A setting of “0” produces no sound, while a setting of “20” produces maximum volume. Press the **[-/NO]** and **[+/YES]** buttons simultaneously to recall the default setting “5”.

Adjust the part volume to a comfortable level to use the “canceled” part as a guide to play along with. Set to “0” if you don’t want to hear the part.

# The Function Mode

## F7 CLP-840/820/820S MIDI Functions

## F8 CLP-880/860 MIDI Functions

### ● A Brief Introduction to MIDI

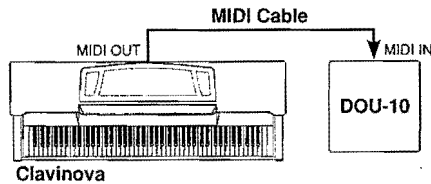

note and velocity (touch response) information via the MIDI OUT connector whenever a note is played on the keyboard. If the MIDI OUT connector is connected to the MIDI IN connector of a second keyboard (synthesizer, etc.) or a tone generator (essentially a synthesizer with no keyboard), the second keyboard or tone generator will respond precisely to notes played on the original transmitting keyboard. The result is that you can effectively play two instruments at once, providing thick multi-instrument sounds.

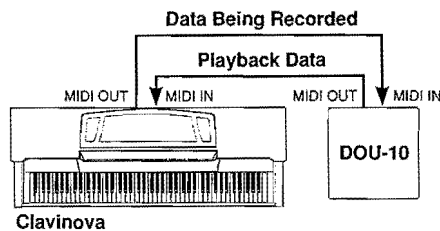

MIDI, the Musical Instrument Digital Interface, is a world-standard communication interface that allows MIDI-compatible musical instruments and equipment to share musical information and control one another. This makes it possible to create "systems" of MIDI instruments and equipment that offer far greater versatility and control than is available with isolated instruments. For example, most MIDI keyboards (including the Clavinova, of course) transmit

This same type of musical information transfer is used for MIDI sequence recording. A sequence recorder can be used to "record" MIDI data received from a Clavinova, for example. When the recorded data is played back, the Clavinova automatically "plays" the recorded performance in precise detail.

The examples given above really only scratch the surface. MIDI can do much, much more. The Clavinova MIDI functions allow it to be used in fairly sophisticated MIDI systems.

After selecting "F7.1" or "F8.1", press the [+ / YES] button to engage the MIDI function sub-mode, then use the FUNCTION [◀] and [▶] buttons to select the desired MIDI function, as listed below.



- The rear-panel HOST SELECT switch must be set to "MIDI" in order to use the MIDI connectors. When you use the TO HOST connector, set the HOST SELECT switch to the appropriate position for the type of computer you are using (see page 38). In this situation, all MIDI settings described below will have affect on the MIDI signal in and out of the TO HOST connector.

- Always use a high-quality MIDI cable to connect MIDI OUT to MIDI IN terminals. Never use MIDI cables longer than about 15 meters, since cables longer than this can pick up noise which can cause data errors.

### F7.1/F8.1: MIDI Transmit Channel Selection .....

### F7.2/F8.2: MIDI Receive Channel Selection .....

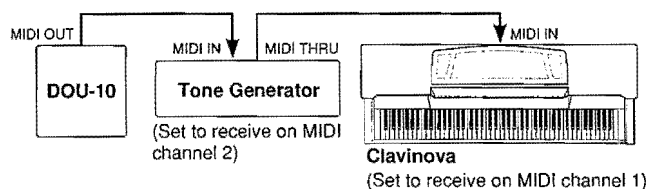

The MIDI system allows transmission and reception of MIDI data on 16 different channels. Multiple channels have been implemented to allow selective control of certain instruments or devices connected in series. For example, a single

MIDI sequence recorder could be used to "play" two different instruments or tone generators. One of the instruments or tone generators could be set to receive only on channel 1, while the other is set to receive on channel 2. In this situation the first instrument or tone generator will respond only to channel-1 information transmitted by the sequence recorder, while the second instrument or tone generator will respond only to channel-2 information. This allows the same

In any MIDI control setup, the MIDI channels of the transmitting and receiving equipment must be matched for proper data transfer. A "Multi-timbre" receive mode is also available, which allows simultaneous reception of different parts on all 16 MIDI channels, allowing the Clavinova to play multi-channel song data received from a music computer or sequencer. There's also a "1-2" mode which allows simultaneous reception on channels 1 and 2.

Use the [-/NO] and [+ /YES] buttons to select the desired transmit or receive channel. The transmit channel parameter can also be turned "OFF" if you don't want the Clavinova to transmit any MIDI data. To select the multi-timbre receive mode, set the receive channel to "ALL". Select "1-2" for multi-timbre reception on channels 1 and 2 only.

Press the [-/NO] and [+ /YES] buttons simultaneously to recall the default setting: transmit = "1"; receive = "ALL".



- In the dual mode first voice data is transmitted on its set channel, and in the split mode right voice data is transmitted on its set channel. In the dual mode second voice data is transmitted on the next greater channel number of the set channel, and in the split mode left voice data is transmitted on the next greater channel number of the set channel. In either mode, no data is transmitted if the transmit channel is set to "OFF".
- Demo/piano song data and recorder playback data are not transmitted via MIDI.
- No MIDI reception occurs when the demo/piano song mode is engaged.
- Program change and other like channel messages received will not affect the Clavinova's panel settings or what is being played on the keyboard.

## F7.3/F8.3: Local Control ON/OFF .....

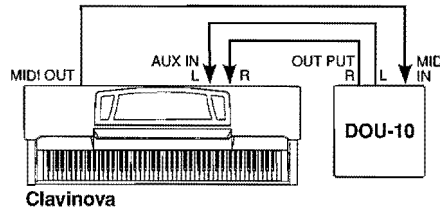

"Local Control" refers to the fact that, normally, the Clavinova keyboard controls its internal tone generator, allowing the internal voices to be played directly from the keyboard. This situation is "Local Control On" since the internal tone generator is controlled locally by its own keyboard.

Local control can be turned OFF, however, so that the Clavinova keyboard does not play the internal voices, but the appropriate MIDI information is still transmitted via the MIDI OUT connector when notes are played on the keyboard. At the same time, the internal tone generator responds to MIDI information received via the MIDI IN connector.

When using the DOU-10 Disk Orchestra Unit with the Clavinova, for example, Local Control should be turned OFF when recording using the DOU-10 voices only, and ON when recording the Clavinova voices while listening to playback of the DOU-10 voices.

Use the [-/NO] and [+ /YES] buttons to turn local control "On" or "OFF".

Press the [-/NO] and [+ /YES] buttons simultaneously to recall the default setting "On".

## F7.4/F8.4: Program Change ON/OFF .....

Normally the Clavinova will respond to MIDI program change numbers received from an external keyboard or other MIDI device, causing the correspondingly numbered voice to be selected on the corresponding channel (the keyboard voice does not change). The Clavinova will normally also send a MIDI program change number whenever one of its voices is selected, causing the correspondingly numbered voice or program to be selected on the external MIDI device if the device is set up to receive and respond to MIDI program change numbers.

This function makes it possible to cancel program change number reception and transmission so that voices can be selected on the Clavinova without affecting the external MIDI device.

Use the [-/NO] and [+ /YES] buttons to turn program change transmission and reception "On" or "OFF".

Press the [-/NO] and [+ /YES] buttons simultaneously to recall the default setting "On".

## **F7.5/F8.5: Control Change ON/OFF** .....

Normally the Clavinova will respond to MIDI control change data received from an external MIDI device or keyboard, causing the voice on the corresponding channel to be affected by pedal and other "control" settings received from the controlling device (the keyboard voice is not affected). The Clavinova also transmits MIDI control change information when one of its pedals or other appropriate controls are operated.

This function makes it possible to cancel control change data reception and transmission so that, for example, the Clavinova pedals and other controls can be operated without affecting an external MIDI device.

Use the [-/NO] and [+ /YES] buttons to turn control change transmission and reception "On" or "OFF".

Press the [-/NO] and [+ /YES] buttons simultaneously to recall the default setting "On".

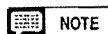

• For information on control changes that can be used with the Clavinova, refer to the MIDI Data Format on page 43.

## **F7.6/F8.6: MIDI Transmit Transpose** .....

This function allows the MIDI note data transmitted by the Clavinova to be transposed up or down in semitone increments by up to plus or minus 12 semitones. The pitch of the Clavinova itself is not affected.

Use the [-/NO] and [+ /YES] buttons to set the desired amount of MIDI transmit transposition. The range is from "-12" (down one octave) through "0" (no transposition) to "12" (up one octave).

Press the [-/NO] and [+ /YES] buttons simultaneously to recall the default setting "0".

## **F7.7/F8.7: Panel/Status Transmit** .....

This function causes all the current Clavinova panel settings (selected voice, etc.) to be transmitted via the MIDI OUT terminal. This is particularly useful if you will be recording performances to a MIDI sequence recorder such as the Yamaha MIDI Data Filer MDF3 which will be used to control the Clavinova on playback. By transmitting the Clavinova panel settings and recording them on the MIDI sequence recorder prior to the actual performance data, the Clavinova will be automatically restored to the same settings when the performance is played back.

Press the [+ /YES] button to transmit the panel/status data. "E n d" will appear on the LED display when the data has been successfully transmitted.



- See page 44 for list of the "Panel Data Contents" transmitted by this function.
- Panel setting data that is transmitted to an external device can only be reloaded on a model of the same type. Panel setting data can also be directly transferred to or from instruments of the same model type.

## **F7.8/F8.8: Bulk Data Dump** .....

This function is used to transmit all data stored in the Recorder memory to a MIDI data storage device such as the Yamaha MIDI Data Filer MDF3, other sequence recorders, or MIDI compatible computers.

Press the [+ /YES] button to begin bulk transmission. "E n d" will appear on the LED display when the data has been successfully transmitted.



- Bulk data dump will not function when the recorder is in operation.
- Recorder data that is transmitted to an external device can only be reloaded on a model of the same type. Recorder data can also be directly transferred to or from instruments of the same model type.
- The reload operation cannot be executed when the Recorder is in operation or the Function mode is

## F8 CLP-840/820/820S Backup Functions

## F9 CLP-880/860 Backup Functions

After selecting “F8.Y” or “F9.Y”, press the [+ / YES] button to engage the backup function sub-mode, then use the FUNCTION [◀] and [▶] buttons to select the desired backup function, as listed below.



**NOTE**

- The backup settings themselves, and the contents of the recorder memory, are always backed up.
- Even if the Backup is turned on, factory presets can be recalled at any time (see page 40). The factory setting list is found on page 42.

Even if backup is turned on via one of the functions described below, the data will only be retained in memory for about 1 week if the power is not turned on during this time. If the backup period is exceeded, all settings will be reset to their default values. If you want to retain the backup settings for longer periods, be sure to turn the power switch on for a few minutes at least once a week.

### F8.1/F9.1: Voice

Turns backup of the voice functions listed below on or off. Use the [- / NO] and [+ / YES] buttons to turn backup “On” or “OFF”.

The default backup mode is “OFF”.

- Voice (Keyboard, Dual, and Split)
- Dual (ON/OFF, Voice, and Dual Functions for each voice combination)
- Split (ON/OFF, Voice, and Split Functions for each voice combination : CLP-880/860)
- Reverb (ON/OFF, Type, and Depth for each voice)
- Effect (ON/OFF, Type, and Depth for each voice : CLP-880/860/840)
- Variation (for each voice)
- Touch Sensitivity (including the FIXED volume)
- Metronome (Beat, Volume)
- Piano Song Part Cancel Volume

### F8.2/F9.2: MIDI

Turns backup of the MIDI functions listed below on or off. Use the [- / NO] and [+ / YES] buttons to turn backup “On” or “OFF”.

The default backup mode is “OFF”.

- Channel (Transmit, Receive)
- Local ON/OFF
- Program Change ON/OFF
- Control Change ON/OFF
- MIDI Transmit Transpose

### F8.3/F9.3: Tuning

Turns backup of the tuning functions listed below on or off. Use the [- / NO] and [+ / YES] buttons to turn backup “On” or “OFF”.

The default backup mode is “OFF”.

- Transpose
- Tuning
- Scale (including base note)

### F8.4/F9.4: Pedal

Turns backup of the pedal functions listed below on or off. Use the [- / NO] and [+ / YES] buttons to turn backup “On” or “OFF”.

The default backup mode is “OFF”.

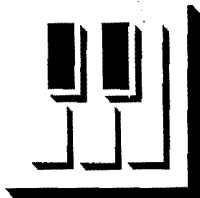

# Connecting to a Personal Computer

Although the Clavinova can be connected to a personal computer via the MIDI IN/OUT connectors and a MIDI interface, the TO HOST connector and HOST SELECT switch allow direct connection to Apple Macintosh or IBM-PC/AT personal computers for sequencing and other music applications without the need for a separate MIDI interface.

## Connecting to an Apple Macintosh Series Computer

Connect the TO HOST connector of the Clavinova to the modem or printer port on your Macintosh, depending on which port your MIDI software is using for MIDI data communication, using a standard Macintosh 8-pin system peripheral cable. Set the HOST SELECT switch to the "Mac" position.

You may also have to make other MIDI interface settings on the computer side, depending on the type of software you use (refer to your software owner's manual). In any case the clock speed should be set to 1 MHz.

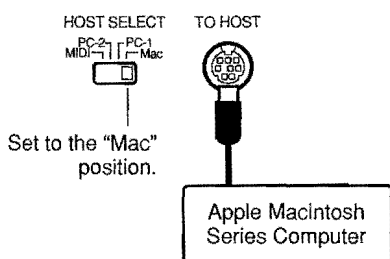

### ● "Mac" Cable Connections

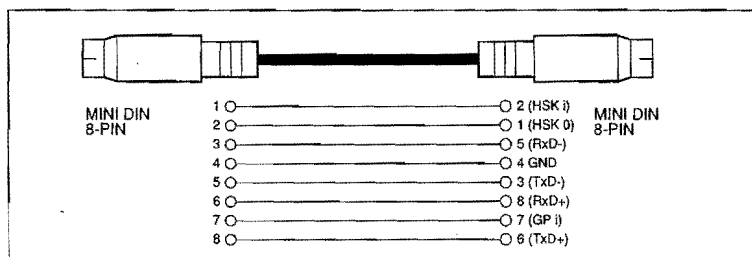

- 8-pin system peripheral cable.
- Data transfer rate: 31,250 bps.

#### NOTE

- When using the [TO HOST] terminal of the Clavinova, first turn the power off on both the Clavinova and the computer before connecting the cable. After connecting the cable, turn the power of the computer on first, then the Clavinova.
- When not using the [TO HOST] terminal of the Clavinova, make sure the cable is disconnected from the [TO HOST] terminal. If the cable is left connected, the Clavinova may not function properly.
- "HST" will appear in the display if the host computer is not turned on, the connecting cable is not properly connected, the HOST SELECT switch is not in the proper position, or the MIDI driver or MIDI application is not active. In this case, turn the power off on both the Clavinova and the computer, and check the cable connection and the position of the HOST SELECT switch. Once the connection and HOST SELECT switch position is verified, turn the power of the computer on first, then the Clavinova, to check if the MIDI driver and MIDI application function properly.
- When the HOST SELECT switch is set to "Mac", "PC-1", or "PC-2", no data transfer occurs via the MIDI connectors. To use the MIDI connectors for connection via a standard MIDI interface, set the HOST SELECT switch to "MIDI".

# Connecting to a Personal Computer

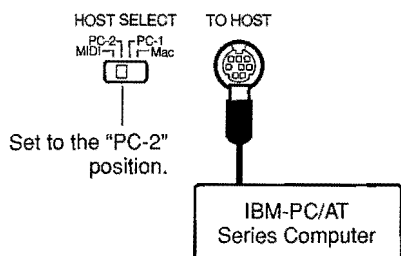

## Connecting to an IBM-PC/AT Series Computer .....

Connect the TO HOST connector of the Clavinova to the RS-232C port on your IBM computer, using a standard 8-pin MINI DIN → 9-pin D-SUB cross cable. Set the HOST SELECT switch to the "PC-2" position.

Refer to your software owner's manual for information on any settings you might have to make on the computer side.

### ● "PC-2" Cable Connections

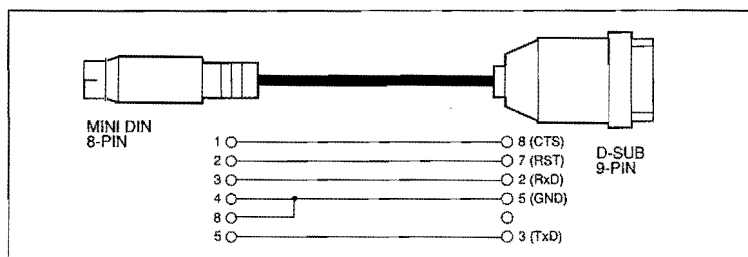

- 8-pin mini DIN → 9-pin D-SUB cable.
- Data transfer rate: 38,400 bps.

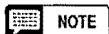

#### NOTE

- If your system doesn't work properly with the connections and settings listed above, your software may require different settings. Check your software operation manual and if it requires a 31,250 bps. data transfer rate, set the HOST SELECT switch to "PC-1".
- When using the TO HOST terminal to connect to a personal computer using Windows, a Yamaha MIDI driver must be installed in the personal computer. The Yamaha MIDI driver can be obtained at Yamaha's home page on the World Wide Web, <<http://www.yamaha.co.jp/english/xg/>>.

### ● Connector Pin Numbers

MINI DIN 8-PIN



D-SUB 9-PIN

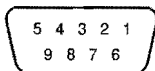

### ■ Trademarks

- Apple and Macintosh are trademarks of Apple Computer, Inc.
- IBM-PC/AT is a trademark of International Business Machines Corporation.
- Windows is the registered trademark of Microsoft® Corporation.

All other trademarks are the property of their respective holders.

# Factory Preset Recall

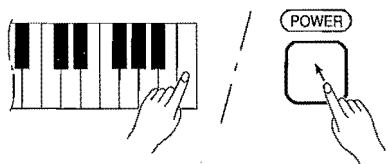

All dual mode, split mode, reverb, effect, touch sensitivity, tuning settings, and the settings affected by the Backup Functions can be restored to their original factory preset values by holding the C7 key (rightmost key on the keyboard) while turning the [POWER] switch ON. This also erases all recorder data, and sets all Backup on/off settings (F8: CLP-840/820/820S, F9: CLP-880/860) to "OFF".



• The factory setting list is found on page 42.

# Troubleshooting

If you encounter what appears to be a malfunction, please check the following points before assuming that your Clavinova is faulty.

## 1. No Sound When the Power is Turned ON

Is the AC plug properly connected to the Clavinova and an AC wall outlet? Check the AC connection carefully. Is the MASTER VOLUME control turned up to a reasonable listening level?

Also make sure that a pair of headphones is not plugged into the PHONES jack, and that the Local Control (page 35) is ON.

## 2. The Damper Pedal Doesn't Work

If the damper pedal doesn't work, or notes are sustained even when the pedal is not pressed, make sure that the pedal cord is properly plugged into the main unit (page 66: CLP-820S, page 60: CLP-860/840/820, page 52: CLP-880).

## 3. The Clavinova Reproduces Radio or TV Sound

This can occur if there is a high-power transmitter in your vicinity. Contact your Yamaha dealer.

- If "Scn" appears on the display an internal malfunction has occurred. In this case, contact your Yamaha dealer.

## 4. Intermittent Static Noise

This is usually due to turning ON or OFF a household appliance or other electronic equipment which is fed by the same AC mains line as your Clavinova.

## 5. Interference Appears On Radio or TV Sets Located Near the Clavinova

The Clavinova contains digital circuitry which can generate radio-frequency noise. The solution is to move the Clavinova further away from the affected equipment, or vice versa.

## 6. Distorted Sound When the Clavinova is Connected to An External Amplifier/Speaker System

If the Clavinova is connected to a stereo system or instrument amplifier and the sound is distorted, reduce the volume of the external equipment to a level at which the distortion ceases.

# Options & Expander Modules

## ● Options

### BC-8 Bench

A comfortable bench styled to match your Yamaha Clavinova.

### HPE-160 Stereo Headphones

High-performance lightweight dynamic headphones with extra-soft ear pads.

### KC-883 Key Cover (for the CLP-820S only)

A convenient way to keep your keyboard clean and

## ● Expander Modules

### DOU-10 Disk Orchestra Unit

A range of MIDI recording and playback functions, plus Yamaha DOC software, Disklavier PianoSoft™, and General MIDI/Standard MIDI File disk playback capability.