

User Guide Manual

RFS-26B..



Disposal of Used Electrical & Electronic Equipment



The meaning of the symbol on the product, its accessory or packaging indicates that this product shall not be treated as household waste. Please, dispose of this equipment at your applicable collection point for the recycling of electrical & electronic equipments waste.

In the European Union and Other European countries there are separate collection systems for used electrical and electronic product. By ensuring the correct disposal of this product, you will help prevent potential hazards to the environment and to human health, which could otherwise be caused by unsuitable waste handling of this product. The recycling of materials will help conserve natural resources.

Please do not therefore dispose of your old electrical and electronic equipment with your household waste.

For more detailed information about recycling of this product, please contact your local city office or your household waste disposal service.

RoHS (Directive 2002/95/EC) Compliant



This product is environmentally sound and sustainable free from Pb, Cd, Cr+6, Hg, PBBs and PBDEs restricted in accordance with the Directive.

Refrigerant Information (R-134a Models Only)

Refrigerant	R-134a
Charge	0.190kg
Global Warming Potential	1300
Contains fluorinated greenhouse gases covered by the Kyoto Protocol and is hermetically sealed. Foam blown with fluorinated greenhouse gases.	

OBSERVE AMBIENT TEMPERATURE

This refrigerator is designed to operate in ambient temperature specified by its category, which is marked on the rating plate

Climatic category	Ambient temperature from...to
SN	+ 10°C to + 32°C
N	+ 16°C to + 32°C
ST	+ 16°C to + 38°C
T	+ 16°C to + 43°C

NOTE

Internal temperature may be affected by such factors as the location of the refrigerator, ambient temperature and frequency of the door opening.

Contents

Be sure to keep for safety	1~2
Installation Guide	3
Control Panel	4
Temperature Control	5
How to use Interior Parts	6
How to use the Dispenser	7
How to use the Automatic Icemaker	8
Care & Cleaning	9~10
Before You Call for Service... ..	11
Something strange?	
Don't worry. Here is the answer	12
Installation Preparation	13
If the refrigerator can not pass through a door during installation, follow these steps	13
Refrigerator Leveling & Door Adjustment (if needed.)	15
How to install Water Line	16

Be sure to keep for safety!

Read these safety instructions thoroughly and carefully before using. Please keep this user guide on hand for future reference.



Indicates the possibility of danger of death or serious injury.



Indicates the possibility of risk of personal injury or material damage.

Other Signs



DO NOT remove or disassemble!



Be sure to unplug from outlet/mains!



NO. DO NOT...



Be sure to keep and follow!

Caution

1. If the supply cord becomes damaged, it must be replaced by the manufacturer or its service agent or a similarly qualified person in order to avoid a hazard.
2. This appliance is not intended for use by persons (including children) with reduced physical, sensory or mental capabilities, or lack of experience and knowledge, unless they have been given supervision or instruction concerning use of the appliance by a person responsible for their safety.

WARNING



Never let the power cord be crushed by the refrigerator itself or other (heavy) objects.

Never bend power cord excessively.

- If the cord is damaged or peeled, it can be a cause of fire and electric shock.



Do not plug several appliances into the same wall outlet.

- It can be a cause of overheating and/or fire. Use an exclusive grounding receptacle for the refrigerator.



Never hold the power cord or plug with wet hands.

- There is a risk of electric shock.



Never use a damaged power cord or plug, or loose main socket.

- There is a risk of fire, electric shock or serious injury.



Be sure to ground. Check if your wall outlet is grounded (earthed).

- There is a risk of electric shock hazards.



Never unplug by pulling only the power cord wire. Always grip the plug firmly.



Let the cord from the plug outlet be directed downwards.

- If it is directed up, the cord near the plug is bent and can be damaged, which can cause an electric shock or fire.



Do not install the refrigerator on a wet floor or in a place with excessive humidity and moisture.

- Electric insulation gets weakened, resulting in a risk of electric shock hazards.



Never let the power cord touch or pass over heating appliances.

- Power cord can be damaged, resulting in a risk of electric shock hazards.



Check if plug is loose from the wall outlet.

- Electric insulation gets weakened, resulting in a risk of electric shock hazards.



Never pour or spray water into the refrigerator (both interior and exterior).

- Electric insulation gets weakened, resulting in a risk of electric shock hazards.



Do not place containers with water or liquid on top of refrigerator.

- Water can spill into the refrigerator and can cause electric shock hazards or damage.



Do not let children hang on the refrigerator doors.

- Refrigerator can fall and harm them.



Do not move or remove compartment shelves/pockets while foods and containers are on them.

- Hard containers (of glass, metal etc.) can fall to hurt you and can break glass shelf and interior parts.



Never repair, disassemble or amend the refrigerator on your own.

- There is a risk of personal injury or damage to the refrigerator. It is recommended that any service be carried out by a qualified person.



Never store any flammable gas or liquid in the refrigerator.



Never use flammable gas, benzene, thinners, gasoline, spray etc. near the refrigerator.

- There is a risk of fire, explosion and personal injury or damage.



If a gas leak is found near the refrigerator or in the kitchen, ventilate it immediately without touching the power plug or refrigerator.



Do not store medicine, academic research samples which require strict temperature control in the refrigerator.



Never insert fingers or hands into the bottom of the refrigerator, especially into the bottom back.

- You can be hurt by sharp metal edges or can receive an electric shock.



Do not change fuse or LED lamp on your own. Call the service agent to change them.



When you find the power cord damaged or cut, call the service agent immediately.



When you get rid of your old refrigerator, be sure to remove the door packings first.

- Children can be entrapped and suffocated in an abandoned refrigerator.

CAUTION



Be sure to unplug the refrigerator when it is not going to be used for a long time.



Never touch foods and containers especially of metal with wet hands in the freezer compartment.

- You can be hurt by chilblains or cold burns.



Never eat any decayed or deteriorated food at all.

- Foods stored too long in the refrigerator can deteriorate and become decayed.



Never place bottles and containers of glass in the freezer compartment.

- Glass containers and bottles can break and hurt you.



When moving the refrigerator (horizontally or tilted), more than 2 persons are required to hold it.

(One to hold top back handles, the other to hold the bottom holder.)

If other parts are held instead, it is very dangerous and likely to slip.



Be sure to turn up the wheel first before moving the refrigerator.

- The wheels can damage or scratch the floor. If you are moving it for a long distance, never forget to fasten the interior parts tightly with tapes.
- Otherwise, the parts can collide and break each other.

Installation Guide

* Read these safety instructions carefully before use and follow precautions for your safety.

Precautions in installation and power connection

■ To prevent fire, electric shock or leakage

① **Never install the refrigerator on a wet, watery floor or where water can gather easily.**

② **Check the following before power connection.**

- Connect power plug only to a grounded wall socket (an earthed mains).
- Do not plug refrigerator power together with other appliances to the same socket.

③ **Do not use an adapter plug or an extension cord.**

④ **Do not let the power cord be crushed by other (heavy) objects.**

- ※ If you hear a strange noise, strong chemical odour or find smoke etc. from the refrigerator after the power is plugged in, pull out the plug immediately and call the service agent.
- ※ Wait about 5 minutes before you plug-in again in order to prevent any damage to the compressor and electrical devices of refrigerator.
- ※ Wait 2~3 hours until the inside gets cold enough after the first power plug-in, then store foods inside. (There can be some smell of plastic parts on initial operation of the refrigerator after plugging in. The smell fades away as the refrigerator works and doors are opened and closed.)

Precautions in use

■ To prevent personal injury, fire, electric shock etc. read this user guide carefully before use and keep it at hand for any reference.

■ Accessories

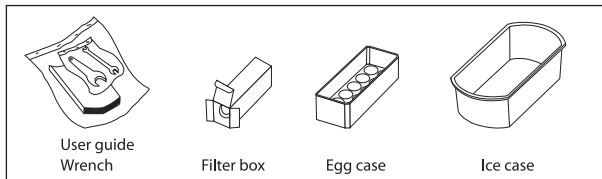

Control Panel

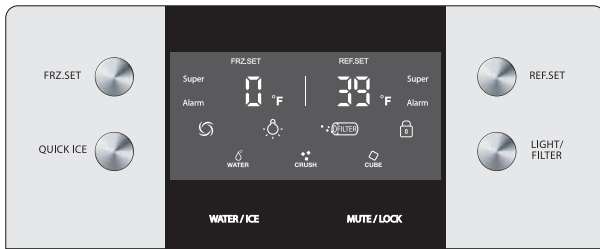

1. FRZ.SET button

Selection button for freezer compartment temperature.

2. QUICK ICE button

Quick ice cube production on/off switch

3. WATER / ICE dispenser button

For your convenience you can select WATER / CUBED ICE or CRUSHED ICE.

A rectangle line around the icon lights up to indicate your selection is ON.

To obtain the water or ice, push the pad smoothly with your cup and your selection will come out 1~2 seconds later.

- Try to avoid placing the rim of your glass near the bottom of the pad, otherwise water or icecubes may spill or splash.

4. MUTE / LOCK button

Switching the warning signal off

Switching panel lock on/off

5. REF.SET button

Selection button for refrigerator compartment temperature.

6. LIGHT/FILTER button

1) Button for dispenser light on.

2) Button for filter exchange or reset.

After exchanging or to reset, press the button for 3 seconds.

7. Symbols on the display panel



Quick ice

appears when the “quick ice” function is on.



Light

appears when the water dispenser light is on.



Water filter : Filter exchange display

After 6 months of first power input, the icon will flicker. When the appliance is turned off, the water filter symbol is reset.



Panel lock

appears when the panel lock is on



- Interior lights of the refrigerator turn off when the doors are open for more than 10 minutes.
- In case either the freezer or refrigerator door is left open for more than a minute, door alarm rings with 1 minute intervals.
- Display off function
 - 1 minute after no buttons or doors are operated by customer, all the display LED turns off.
 - Under the LED off status, it returns to normal display mode when customers operate buttons or doors.
- Alarm function
 - The door warning signal sounds if one of the doors is open for more than one minute, or the temperature inside the appliance is too high.
 - The warning rings with 1 minute intervals and the “ Alarm” will blink on the display.
 - To switch off the warning signal, close the door if a door is open, and press “alarm/lock” button.

Temperature Control

* When this refrigerator is first plugged in, the temperature mode is set to [Middle].

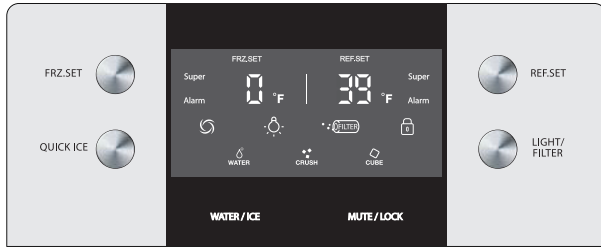

Freezer Compartment

Push the **FRZ.SET** button and the setting temperature changes as the figure shows.

>>> Sequential Temperature Change <<<



Faster Freezing...

When you want faster freezing, push the **FRZ.SET** button, until 'Super' LED turns on. Just push the button again to release.

Refrigerator Compartment

Push the **REF.SET** button and the setting temperature changes as the figure shows.

>>> Sequential Temperature Change <<<

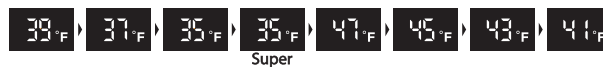

Faster Cooling or Refrigeration

When you want faster freezing, push the **REF.SET** button, until 'Super' LED turns on. Just push the button again to release.



Temperature indicator convert function (Fahrenheit ↔ Celsius)

Press "MUTE/LOCK" button to enter locked mode. Under the locked mode, press and hold "quick ice" button for 15 seconds until the temperature unit switches.

Caution

Food in the refrigerator can be frozen if the ambient temperature of the refrigerator is below 5°C.

How to use the interior parts



* This instruction manual refers to several models. The real features are model dependent.

1. Door storage compartment
for storing butter and cheese.

2. Door storage compartment
for storing refrigerating food of small size.

3. Door storage compartment
for storing refrigerating food.

4. Door storage compartment
for storing refrigerating food.

5. Ice maker/ice storage bin
for making and storing ice

6. Water filter

7. Adjustable glass shelf
for storing common food.

8. Small glass shelf
for storing common food.

9. Vegetable case

10. Wide case

11. Freezer case

12. Freezer drawer

13. Control and display panel

14. Egg case

15. Ice storage case

Caution

- **Do not touch or hold food with wet hands (food container) in the freezer compartment**
⇒ There is a risk of chilblains (cold burns).
- Do not store medicine, academic research samples etc. in the refrigerator.

Food Storage Tips



Wash food before storing.

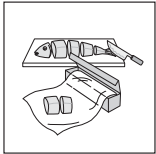

Divide and separate food into smaller pieces.

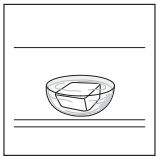

Place watery food or food with a lot of moisture in front shelves (close to door side). If they are placed close to the cold air spout, they can be frozen.



Warm or hot food should be cooled down enough before storing to reduce power consumption and to enhance refrigeration performance.

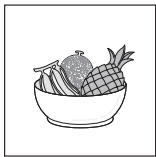

Be careful in storing tropical fruits such as bananas, pineapples and tomatoes, as they can easily deteriorate in lower temperatures.



Keep enough space between the foods. If too tight or too close, cold air circulation is hindered, resulting in poor refrigeration.



Never forget to cover or wrap food to prevent odours.

How to use the Dispenser

Press the WATER/ICE button to select 'WATER', 'CRUSHED ICE' or 'ICE CUBE', and smoothly push the lever with your cup.

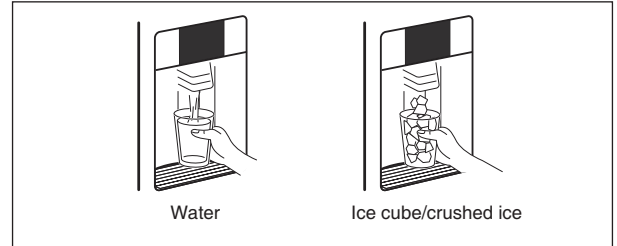

Caution

- Avoid using thin fragile cups or crystal glasses when taking ice cubes.
- For your safety, never insert your fingers or other tools into the dispenser outlet.
- If you find the ices discolored, stop using the dispenser and call the service agent.

How to use the Automatic Icemaker (Dispenser models only)

- The ice maker can make approx, 100 ice cubes within 24 hours. If the ice storage case is full, ice making stops.
- It is normal for the icemaker to make banging sounds when the ice cubes are falling into the ice storage case.
- To prevent bad odour or smell, regularly clean the ice cube's storage case.
- If the amount of ice in the storage case is not sufficient, the ice may not be dispensed. Wait a day or so to make more ice.
- If the ice does not dispense easily, ensure the dispenser outlet is not blocked.

In case the ice maker doesn't work

If the ice cubes get stuck and not dispensed

- Pull out the ice storage case and separate any ice cubes that may have stuck together.
- If the amount of water which is supplied to the icemaker needs adjusting, call for the service agent.

In case of power failure

- The ice cubes in the storage case may melt to flow down to the ice dispenser.
- If many hours of power failure is predicted, pull out the storage case, remove the ice cubes in it and replace it back when power resumes.

Care & Cleaning



Be sure to unplug first

* This instruction manual refers to several models. The real features are model dependent.

① Water Dispenser

- Remove the strainer and clean the water collecting tray with a sponge or absorbent cloth.

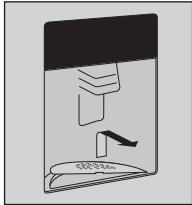

② Ice cubes storage Case

- Removing: Press the release button and remove the ice cube container.
- Cleaning: Empty the ice cube container and clean with tepid water. Thoroughly dry the container and screw conveyor to prevent new ice cubes from sticking.
- Replacing: Push the ice cube container all the way back onto the supports until it locks into position. If the container cannot be pushed all the way back, rotate the swirl coil a quarter turn and insert again.

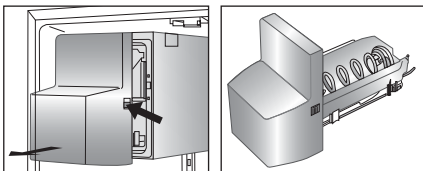

③ Freezer & Refrigerator Bins

- Hold both ends and pull up.

④ Refrigerator Shelves

- Lift up and pull the shelf, unhook and then remove the shelf. You can replace it at varying heights.

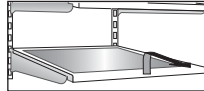

- To place taller items such as tall bottles, you can remove the small glass shelf and place it in the holder under the icemaker.

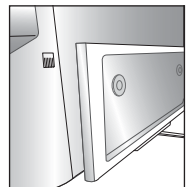

5 Vegetable case & Wide case

- Pull out the cases as far as possible. Lift up the front of the cases and pull them out.
- Insert the cases into the rail and push toward the back.

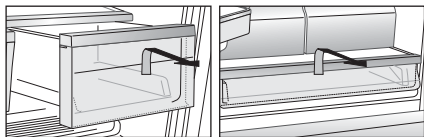

6 Freezer case

- Pull out the case as far as possible. Pull out the clips on both sides and lift up the front of the freezer case.

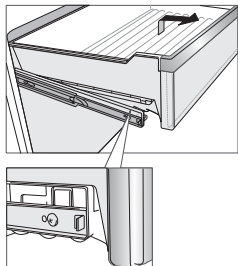

7 Freezer drawer

- Lift the freezer drawer up and out.

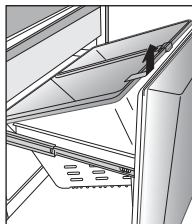

How to Clean

Interior Parts

- Use cloth with water and mild(neutral) detergent to clean.

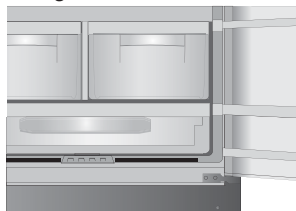

Back (Machine section)

- Remove dust on grill with a vacuum cleaner at least once a year.

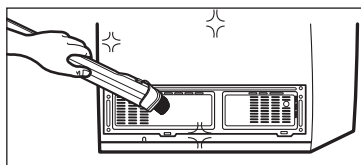

Caution

Never use gasoline (petrol), benzene (benzol), thinners etc., for they can damage the surfaces.



Before You Call for Service...

Please check the following troubleshooting tips before you call for service!

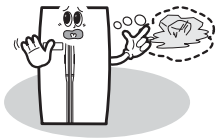

Problem

It never gets cold inside.
Freezing & refrigerating is not so good.

Checkup Point

- 1 Is the refrigerator unplugged?
- 2 Is the temperature set to [Low Mode]?
- 3 Is the refrigerator under direct sunlight or is a heat appliance placed near it?
- 4 Is the space between the refrigerator back and the wall too close?

Action

- 1 Plug in the refrigerator.
- 2 Set the temperature mode to Middle or High.
- 3 Move to a place where there is no direct sunlight, no heat appliances around.
- 4 Keep sufficient space (more than 5cm) between the back of the refrigerator and the wall.



Problem

Foods in the refrigerator get frozen.

Checkup Point

- 1 Is temperature set to [High]?
- 2 Is the room temperature too low?
- 3 Is food with moisture stored close to the cold air spout?

Action

- 1 Set the temperature to [Middle] or [Low].
- 2 Food can be frozen if ambient temperature is below 5°C. Move to a place where the temperature is over 5°C.
- 3 Place food with moisture on the shelves close to the doors.

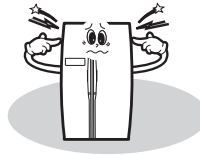

Problem

Strange sounds from the refrigerator.

Checkup Point

- 1 Is the floor beneath the refrigerator uneven?
- 2 Is the space between refrigerator back and the wall too close?
- 3 Do any objects or other stuff touch the refrigerator?

Action

- 1 Move the refrigerator to a level and even floor.
- 2 Keep sufficient space.
- 3 Remove any object which touches the refrigerator.



Problem

Odour or unpleasant smell from the inside.



Checkup Point

- 1 Is the food stored uncovered or unwrapped?
- 2 Are the shelves and pockets stained with food stuff?
- 3 Is the food stored too long?

Action

- 1 Be sure to cover and wrap the food.
- 2 Clean them regularly. Once smell gets soaked into those parts, it is not easy to remove.
- 3 Do not store food for too long. A refrigerator is neither a perfect nor a permanent food keeper.

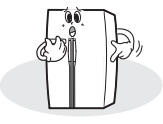
Something strange ? Don't worry. Here is the answer.

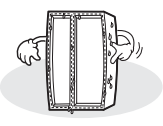
	Case		Explanation
Heat	Front and side of refrigerator feels warm or hot.		<ul style="list-style-type: none"> Pipes (refrigerant vessel) are placed beneath the surface to prevent moisture forming on it.
Door is sticky	Doors do not open easily.		<ul style="list-style-type: none"> When you close the door and then open again immediately, the door is not easy to open because warm air rushes in and creates the pressure difference. In this case wait for a minute, then it will open easily.
Strange Sound	It sounds like water is flowing from the refrigerator.		<ul style="list-style-type: none"> When the compressor starts to run or stop, refrigerant which makes the inside cold flowing in the pipes can make such a sound. Defrosted water can also make such a sound. (This refrigerator adopts an automatic defrosting system.)
	Cracking or clicking sounds.		<ul style="list-style-type: none"> Inside parts shrink and/or expand due to temperature change --- When the inside gets cold or when the door is open, such sounds can be made.
	Humming or buzzing sounds.		<ul style="list-style-type: none"> Compressor or fans for cold air circulation can make such working sound. (If the refrigerator is not level, the sound can be louder.)
Frost & Dew	Dew or frost on the wall and/or food container surface in the freezer and refrigerator compartment.		<p>Frost and/or dew can be made in the following cases;</p> <ul style="list-style-type: none"> High temperature and/or high humidity around the refrigerator. When doors are open too long. Food with much moisture are stored uncovered or unwrapped. <p>※You can see the same appearance when cold water is poured in a glass cup and dew is forming on the surface of it.</p>
	Dew on the cabinet surface.		<ul style="list-style-type: none"> If it is highly humid around the refrigerator, moisture in the air sticks to the surface to form dew.

Installation Preparation

Check if the refrigerator can pass a doorway or enter a door first.

Dimensions (including Door Handles)

(Width*Depth*Height) 36inches x 36.3inches x 69.8inches

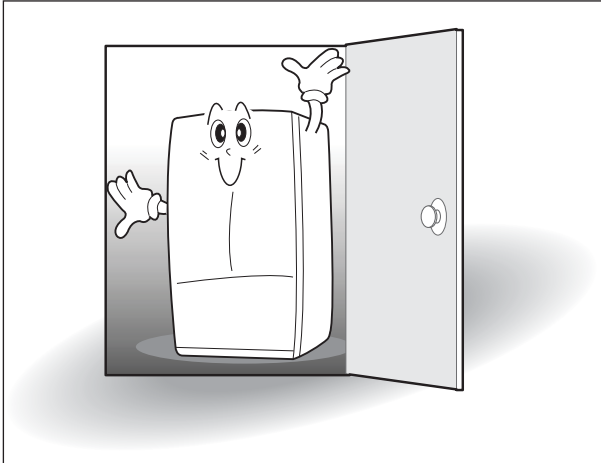

Find a suitable place to install

Sufficient space from refrigerator back to the wall for free air ventilation.

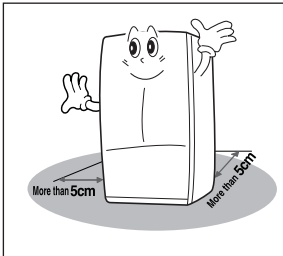

Avoid direct sunlight.

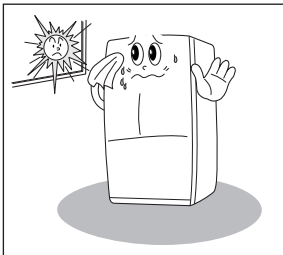

● Once the installation place is ready, follow the installation instructions.
If the surrounding temperature of refrigerator is low (below 5°C), food can be frozen or the refrigerator can work in abnormal way.

If the refrigerator can not pass through a door during installation, follow these steps.

※ This instruction manual refers to several models. The real features are model dependent.

Removing left refrigerator door

- 1 Unscrew top hinge cover with a screw driver and remove the hinge cover.

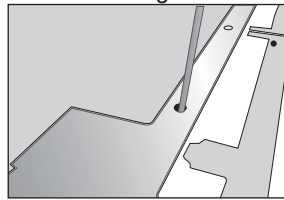

- 2 Unscrew the earth and disconnect the harness wires and water tube.

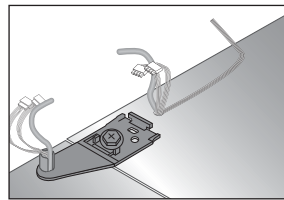

- 3 Turn top hinge fastener counterclockwise and remove the top hinge. (After the hinge is removed, the door can fall down forward. Be careful!)

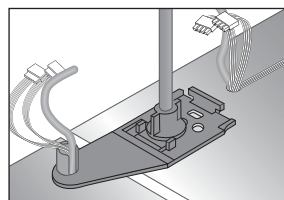

Caution

※ Risk of electric shock! Before removing top hinge cover:

- Shut off the water supply to the appliance.
- Unplug the appliance or switch off the fuse.

Removing right refrigerator door

1. Turn top hinge fastener counterclockwise and remove the top hinge.(After the hinge is removed the door can fall down forward. Be careful!)
2. Lift up the door and remove it.(The same as step4, step5 in the removing the left refrigerator door)

Removing freezer door

- 1 Open freezer door as far as possible, pull up freezer case and freezer drawer.

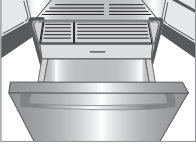

- 2 Push locks(on both sides) and pull forward Freezer door and remove.



Replacing refrigerator doors

- Replace the left door, right door, then replace the top hinge cover.
- Replacing steps are the reverses of the steps of removing the doors.

Replacing freezer door

- 1 Align the end of rails(both sides) with supporter of freezer drawer rail



- 2 Fully push and close freezer door , check locking of the rail with the lock of supporter

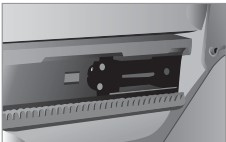

- 3 Open the freezer as far as possible, assemble one gear rail in supporter of rail gear.

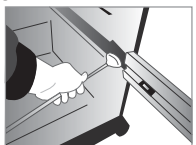

- 4 Push and assemble another gear rail on opposite side of the rail



Refrigerator Leveling & Door Adjustment(If needed.)

The refrigerator must be level in order to maintain optimal performance and desirable front appearance.
(If the floor beneath the refrigerator is uneven, The freezer and refrigerator doors look unbalanced.)

leveling and door adjustment

Leveling the appliance

- 1 Remove the front cover, if it is attached.

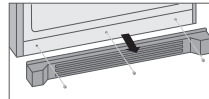

- 2 Use a hexagonal wrench to align the front of the appliance.

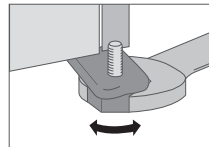

Adjusting a refrigerator door

If the height of the refrigerator doors is uneven, turn the screw nut on the lower hinge to adjust the refrigerator door.

- To raise a refrigerator door turn the screw counterclockwise.

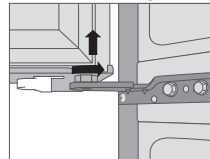

- To lower a refrigerator door turn the screw clockwise.

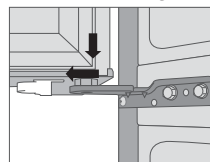

Aligning the refrigerator doors

Caution

※ Risk of electric shock! Before removing top hinge cover

- Shut off the water supply to the appliance.
- Unplug the appliance or switch off the fuse.

If the refrigerator doors are not properly aligned

- 1 Unscrew the top hinge cover and raise the panel
Do not disconnect any harness wire or water tube!

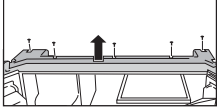

- 2 Loosen the fastener counterclockwise, move the hinge sideway to adjust the refrigerator door.
Do not remove the fastener!

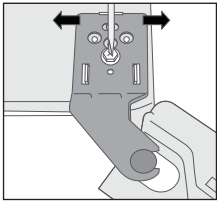

- 3 Tighten the fastener and replace the top hinge cover.

Adjusting the freezer drawer

If the freezer drawer is not even.

1. Loosen the two side fasteners.
Do not remove the fasteners!
2. Use the top fastener to adjust the freezer drawer.
3. If level of freezer drawer is proper, tighten the two side fasteners.

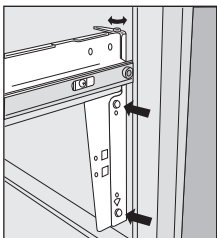

Front Cover

After installation and/or door leveling, fasten front cover with screws. (Remove the screws on the front bottom panel first. Click and screw the cover)

Caution

- The front of refrigerator needs to be just a little higher than the back for easy door closing, but if the wheel is raised too much for door balance, i.e. the front of refrigerator is much higher than the back, it can be difficult to open the door.

Installing the handles

- After installation and/or door leveling, Install the handles.
- All the handles are identical

- 1 Insert refrigerator door handles into guide, the direction of set screw being to the center of the appliance.
Fasten the set screw with the L- wrench(supplied).

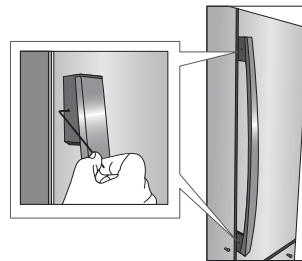
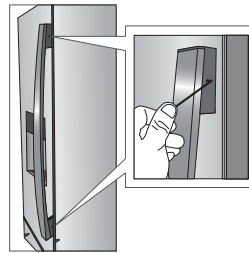

- 2 Insert freezer door handles into guide, the direction of set screw being to downward.
Fasten the set screw with the L- wrench(supplied).

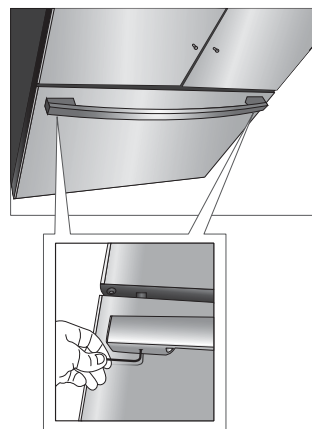

Foldaway door bar (mullion bar)

- When closing the left refrigerator door, the mullion bar folds behind the right refrigerator door, forming a seal between the refrigerator doors.
- When opening the left refrigerator door, the mullion bar folds back to the left door automatically.

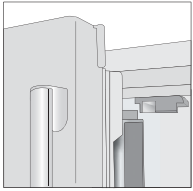

(mullion bar folds back O)

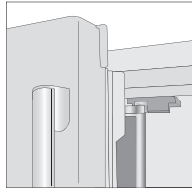

(mullion bar folds away X)

- The mullion bar becomes damaged if you attempt to close the left refrigerator door with the mullion bar folded away. When closing the left refrigerator door, make sure the mullion bar is folded back.

Water filter

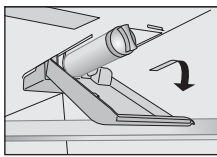

1. Disconnect the water supply to the appliance.
2. Remove the locking cap for installing the filter.

(The ice and water dispenser can also be used without a water filter, in which case the locking cap must be used.)

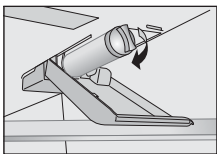

3. Carefully turn the filter clockwise.
4. Change the filter at least every 6 months.

□ A New filter can be obtained from aftersales service.



Caution

- Wipe up with cloth if droplets fall when exchanging a filter. Draw water from the water dispenser for 5 minutes before use. This will remove air from the water system.

Information concerning the water filter

- After use, the water system is subject to low pressure. Proceed with caution when removing the filter.
- Flush the water system if the appliance has not been in use for a lengthy period, or if the ice/water has an unpleasant taste or smell. To do this, dispense water through the water dispenser for several minutes. If the unpleasant taste or smell remains, replace the filter.
- Protect from frost, remove the filter cartridge if you expect the temperature to drop below freezing.
- If pressure surges could occur in the water pipe. Do not install the water filter without a suitable surge eliminator. Contact an installation expert if you are not sure whether pressure surges could occur in the water pipe.
- After installing a new filter:
Discard any ice produced in the first 24 hours after switching on.
- If no ice has been removed for a lengthy period: Empty the ice box and discard any ice produced over the next 24 hours.

How to install Water Line

1. The water pressure should be 2.0 ~ 8.8kgf/cm² (1.96~8.62 Bar) or more to run the automatic icemaker. Checkup your tap water pressure; if a cup of 180cc is full within 10 seconds, the pressure is OK.
2. When installing the water tubes, ensure they are not close to any hot surfaces.
3. The water filter only filters water; it does not eliminate any bacteria or microbes.
4. If the water pressure is not so high to run the icemaker, call the local plumber to get an additional water pressure pump.
5. If the water pressure exceeds 8.8kgf/cm² (8.62Bar) a pressure reducing valve must be installed.
6. The filter life depends on the amount of use. We recommend you replace the filter at least once every 6 months.
7. After installation of refrigerator and water line system, select [WATER] on your control panel and press it for 2~3 minutes to supply water into the water tank and dispense water.
8. Use sealing tape to every connection of pipes/tubes to ensure there is no water leak.
9. The water tube should be connected to the cold water line.

WATER SUPPLY KIT

※ Connecting the water line to the refrigerator.

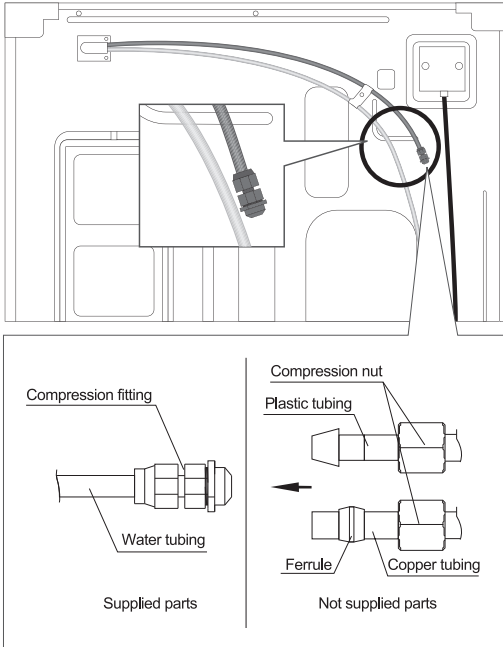

(Necessary parts are available at local service agents.)

1. Connect water line to the compression fitting.
 - If you are using copper tubing (not supplied), slip the compression nut (not supplied) and ferrule (not supplied) on copper tubing.
 - If you are using plastic tubing (not supplied), insert the molded ending of the plastic tubing into the compression fitting.
2. Tighten the compression nut onto the compression fitting.
3. Turn the water on and check for any leakage.

Limited Warranty



DAEWOO ELECTRONICS AMERICA INC. warrants the following Refrigerators to be free from defective material and workmanship and agrees to remedy any such defect or to furnish a new part (at the Company's option) in exchange for any part of any unit of its manufacture which under normal installation, use and service disclosed such defect, provided the unit is delivered by the owner to us or to our authorized distributor from whom purchased or authorized service station, intact, for our examination with all transportation charges prepaid to our factory. To establish and receive warranty service at our factory or authorized service facilities, a sales receipt or bill of sales is required for proof of purchase.

Written authorization must be obtained before any merchandise is returned to the factory.

This warranty does not extend to any of our electronic products which have been subjected to misuse, neglect, accident, incorrect wiring not our own, improper installation, unauthorized modification, or to use in violation of instructions furnished by us, nor units which have been repaired or altered outside of our factory, nor to cases where the serial number there of has removed, defaced, or changed.

This warranty is in lieu of all warranties expressed or implied and no representative or person is authorized to assume for us any other liability in connection with the sales of our electronic products.

For units that are initially defective.

Initial defective is described as when the dealer opens the unit and finds that it is inoperative or an individual customer opening a new unit and finding that it is initially defective. This unit may be returned to the factory by the dealer for exchange. Under no circumstances will an individual customer be permitted to return defective unit directly to factory. Exchange must be directly with the dealer. When this unit is returned to dealer, a copy of the purchase evidence stating the date of purchase is to be put in the individual box for dealer's further control with the factory.

<u>MODEL</u>	<u>PARTS</u>	<u>LABOR</u>	<u>COMPRESSOR</u>
Refrigerator	1 year	1year	5years

Model : RFS-26BSD, RFS-26BTD, RFS-26BWD, RFS-26BBD

Note: **For Service or Assistance, please call : 1-877-DWE-ASC5, 1-877-DWE-SVC3**