

Crestron **RACK2**
2-Series Card Cage System

Operations Guide



CRESTRON

This document was prepared and written by the Technical Documentation department at:



Crestron Electronics, Inc.
15 Volvo Drive
Rockleigh, NJ 07647
1-888-CRESTRON

Contents

2-Series Card Cage System: RACK2	1
Introduction	1
Features and Functions	1
Physical Description	4
On-Board Memory	16
Expandable Memory (Compact Flash)	17
Industry Compliance	18
Setup	18
Rack Mounting	18
Network Wiring	19
Hardware Hookup	20
Establishing Communication with the RACK2	21
Troubleshooting Communications	23
Compiling and Uploading a Program to the Control System	25
Uploading Web Pages to the RACK2	26
Uploading Touchpanel Projects via the RACK2	27
Updating the Operating System	27
Running Programs From Compact Flash	28
Other Compact-Flash-Related Functions	28
Advanced Console Commands	28
Programming	29
Programming with the Crestron AppBuilder	30
Programming with SIMPL Windows	30
Programming the LCD Screen	34
Problem Solving	39
Possible Problems with the Control System	39
Serial Communication Difficulties with Other Devices Connected to the Control System	41
Further Inquiries	44
Firmware Upgrades	44
Future Updates	44
Software License Agreement	45
Return and Warranty Policies	47
Merchandise Returns / Repair Service	47
CRESTRON Limited Warranty	47

2-Series Card Cage System: RACK2

Introduction

Features and Functions

The RACK2 is an integral part of the Crestron® 2-Series generation of control system technology featuring the newest series of Ethernet/LAN compatible control systems. The RACK2 is a modular “card cage” control system that includes the CPU2 (central processing unit) and the NET2 (Cresnet® communications hub). The RACK2 offers the ultimate in flexibility and customization. Sixteen expansion cards may be added to the RACK2. The variety of available 2-Series and X-Generation expansion cards provides a very high degree of functionality; therefore making this type of system suitable for relatively large systems. The RACK2 requires an external power supply (CNPWS-75 not included).

Functional Summary

- Powered by 2-Series control engine.
- 36 MB of internal memory.
- 4 GB expansion slot for Type II compact flash and IBM Microdrive® hard disk drive.
- A multifunction LCD screen (which can be programmed as a local panel interface) displays front panel diagnostics, system errors, and monitors expansion slots.
- RS-232 computer connection (with front and rear ports) for processor communication.
- One Cresnet port on CPU2 (supplies power to the RACK2).
- Built-in Cresnet Hub Expander, eight connectors – 100% compatible with all existing network devices and touchpanels.
- Supports SIMPL Windows & SIMPL+® program applications.
- Four Z-Bus expansion slots and twelve Y-Bus expansion slots.
- Rack mountable, ears included.

The RACK2 is a completely new solution-driven control technology that is also a network information control system. With its exclusive solutions card frame and built-in Cresnet expander hub (NET2), it's the highly configurable solution for even the most sophisticated A/V applications like media help desks, command and control centers, distance learning, and head ends. At the heart of the RACK2 is the breakthrough 2-Series Control Engine, based on the hot new 257 MIPS, 32-bit Motorola ColdFire[®] processor. Onboard 34MB memory is enhanced with a 4GB expansion slot that supports off-the-shelf Type II compact flash memory and the IBM Microdrive[®] hard disk drive, for on-board storage of program and touchpanel files, room and equipment profiles, upgrades, databases and schedules.

Crestron's unique dual bus system, with its high-speed I/O bus architecture, provides blazing fast throughput, system wide. This dual bus architecture allows the ultimate in control card custom configuration, and also allows you to upgrade to new, higher performance expansion cards while still using your existing cards and software programs. The 40Mb/s Y-Bus supports up to 12, X-Generation and 2-Series control cards in its solutions card frame and serves as the pipeline for IR, serial communications and relays.

NOTE: The X-Generation CNXCOM-2 card is not supported.

The 300Mb/s Z-Bus is designed to support up to four super high-speed expansion cards. Optional Z-Bus cards include: C2ENET-1: Single Port 10/100 BaseT Ethernet, or C2ENET-2: Dual Port WAN-LAN-10/100 BaseT Ethernet. Future support will include: USB, USBII, FireWire, or disc drive array. The dual port Ethernet card has a built-in firewall, which delivers the ultimate in security with on-board Network Address Translator (NAT) and router functions. It supports dynamic and static IP addressing and full duplex TCP/IP and UDP/IP, and offers a WAN port for Internet and corporate-wide communications and a LAN port for room and A/V private network use. The built-in web server provides the ultimate in help desk functions, and uses memory storage on a compact flash card for remote access and control.

The built-in eight-port Cresnet expander hub (NET2) serves as a repeater, splitter and wiring block. It allows the connection of hundreds of additional controlled devices and extended network cabling runs.

The 2-Series real-time operating system is vastly upgraded, yet compatible with existing Crestron software and programming. A key feature is the new Crestron Compiler, which allows any existing Crestron SIMPL Windows control program to be easily recompiled for the 2-Series. The real-time, preemptive multi-tasking/multi-threaded operating system offers a FAT32 file system with long file names for easy and open file management. And the enhanced SIMPL+[®] instruction set is also fully compatible with existing Crestron SIMPL Windows and SIMPL+ programs. With its blinding speed, massive memory and revolutionary Dual Bus architecture, the RACK2 is built from the ground up for high performance, secure Internet communications and dynamic expansion capabilities. Designed for reliability and reinforced by Crestron's True Blue Customer Support, it is part of the complete Crestron line of advanced solutions for audio/video/Internet distribution and control.

Specifications

The following table provides a summary of RACK2 specifications.

Specifications of the RACK2

SPECIFICATION	DETAILS
CPU (CPU2 card included)	32-Bit Motorola ColdFire® Processor
Processor Speed	257 MIPS (Dhrystone 2.1 Benchmark)
Onboard Memory	36MB (4MB flash, 32MB DRAM, 256KB NVRAM) ¹
Expandable Memory	Compact Flash Slot (up to 4GB) accepts standard Type II Compact Flash or IBM Microdrive®
Expansion Slots (16 Slots)	
Z-BUS	1 Ethernet Expansion Card Slot (plus 3 future Ethernet expansion slots)
Y-BUS	12 Expansion Card Slots
Ports/Connectors	1 – Cresnet 4-wire interface (Expandable via Cresnet Poll Accelerator)
NET (CPU2)	
COMPUTER (CPU2 and RACK2)	2 – DB9F PC interface (front and rear panel access)
Hub (NET2 card included)	8 – Net connectors A through H
PWR (NET2)	2 – Power connectors for hub
Power Requirements	24 VDC supplied from an external power supply (not included). Total load factor for the RACK2 with CPU and NET2 is 12 watts ² Requires CNPWS-75 (not included)
Reset Buttons	HWR - Initiates system hardware reset SWR – Program Restart / Program Bypass
LCD Screen	Reverse mode (yellow on black) LCD backlight; 2 lines, up to 40 characters per line
Environmental Temperature	41° to 113°F (5° to 45°C)
Environmental Humidity	10% to 90% RH (non-condensing)
Dimensions & Weight	Height: 7.0 in (17.78 cm) Width: 19.0 in (48.26 cm) – with ears 17.03 in (43.24 cm) – without ears Depth: 8.50 in (21.60 cm) Weight: 9.50 lb (4.32 kg) ³

1 Refer to “On-Board Memory” on page 16.

2 **NOTE:** The total load factor of the RACK2 depends on the components of the control system. Add the power requirements of the RACK2 (which includes the CPU2 and NET2) plus the combined requirements of all expansion cards. Do not exceed 75 watts for total load factor of a single RACK2.

3 Listed weight is for RACK2 with CPU2 and NET2 (no other expansion cards installed).

NOTE: RACK2 requires the NET2 and CPU2 cards to always be present.

Physical Description

The RACK2 is housed in a black enclosure with silk-screened labels on the front panel. On the front panel are:

- A single RS-232 computer port (in parallel with the port on the rear panel)
- Standard LEDs: PWR, NET and ERR
- Local Area Network LEDs: LAN A and B LNK and ACT
- Interface Control Card Slot LEDs: 1 through 16
- Two reset buttons
- A reverse (green characters on a black background) LCD screen with menu function and selection buttons

RACK2 Front View



The rear panel provides 16 open expansion card slots and contains the CPU2 processor and the NET2 Cresnet Hub interface.

- One Cresnet connector (on CPU2).
- A single RS-232 computer port (in parallel with the port on the front panel).
- Memory expansion slot (on CPU2).
- Two banks of four Cresnet network mini connectors (A through H) with LED activity indicators (on NET2).
- Two mini power supply connectors with LED power indicators (on NET2).

RACK2 Rear View (Shown with optional Z-Bus and Y-Bus cards installed)

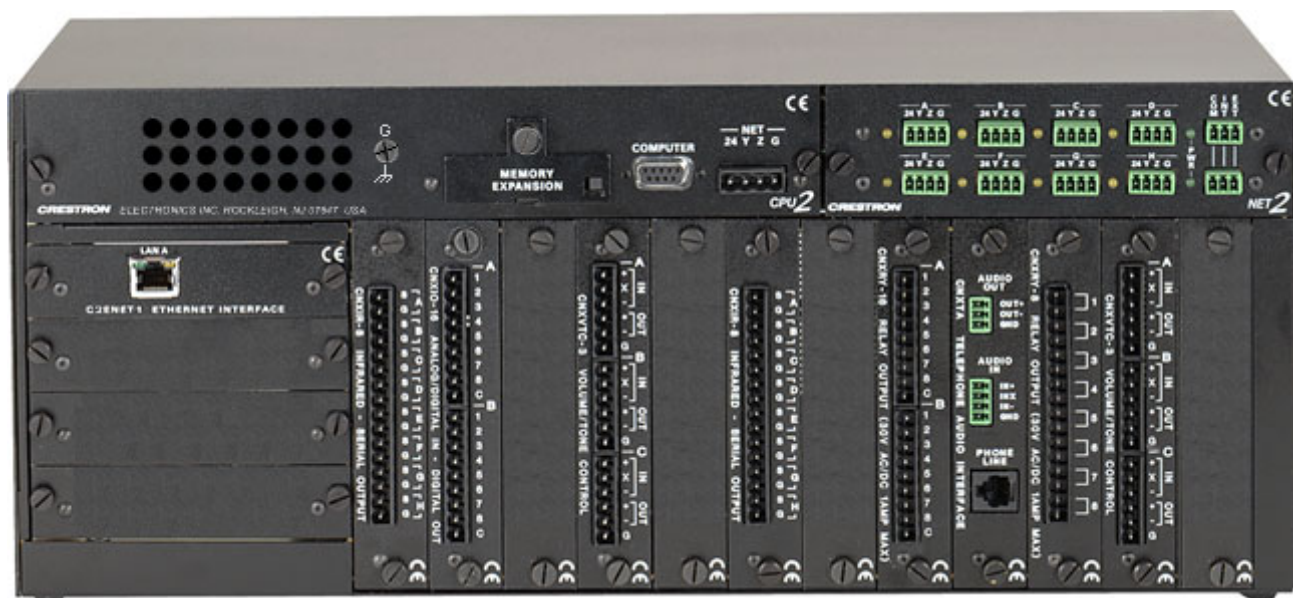

RACK2 Physical View – Front

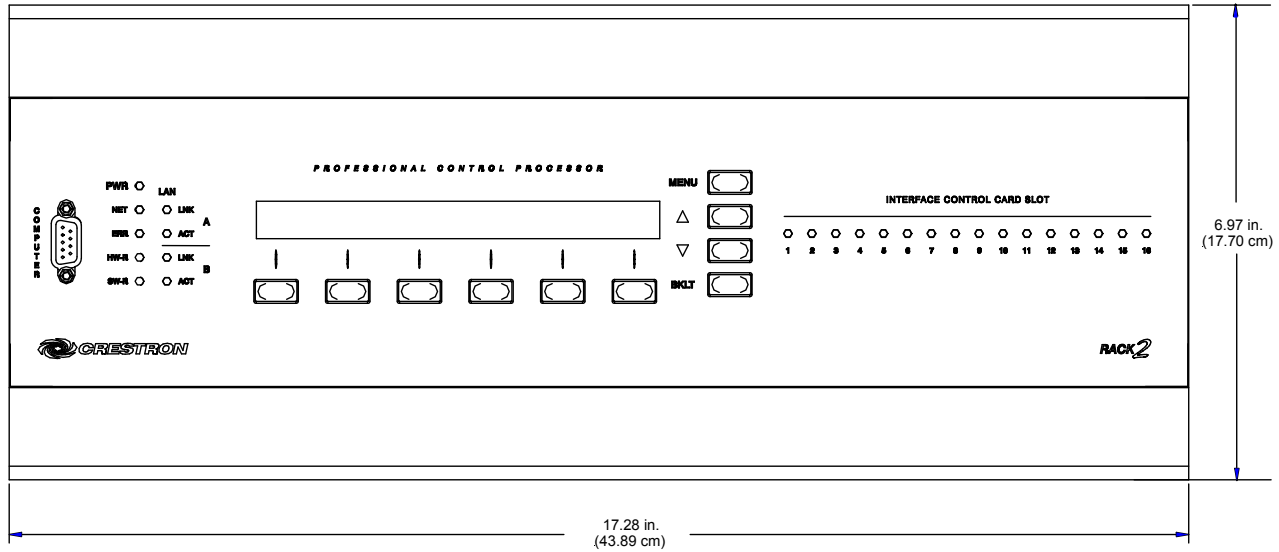

RACK2 Physical View – Side

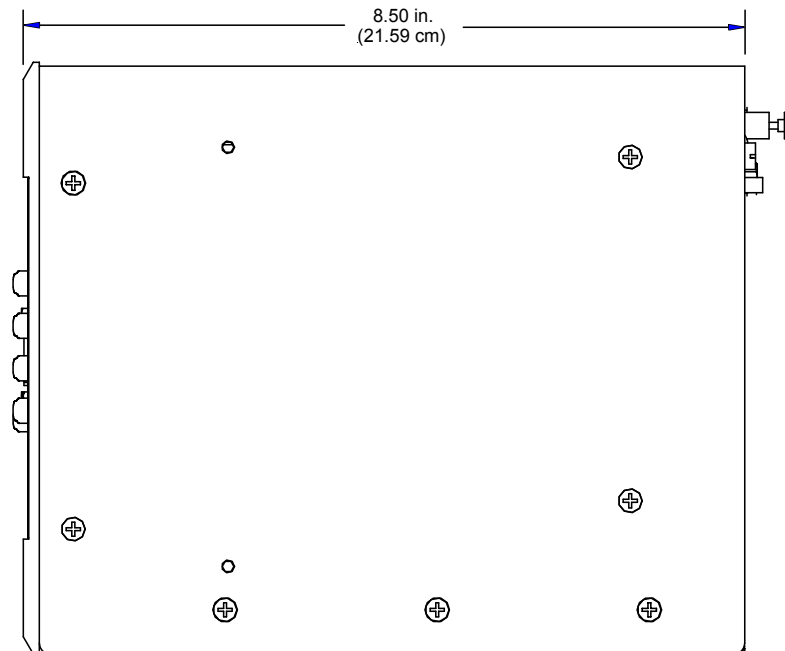

RACK2 Physical View – Rear

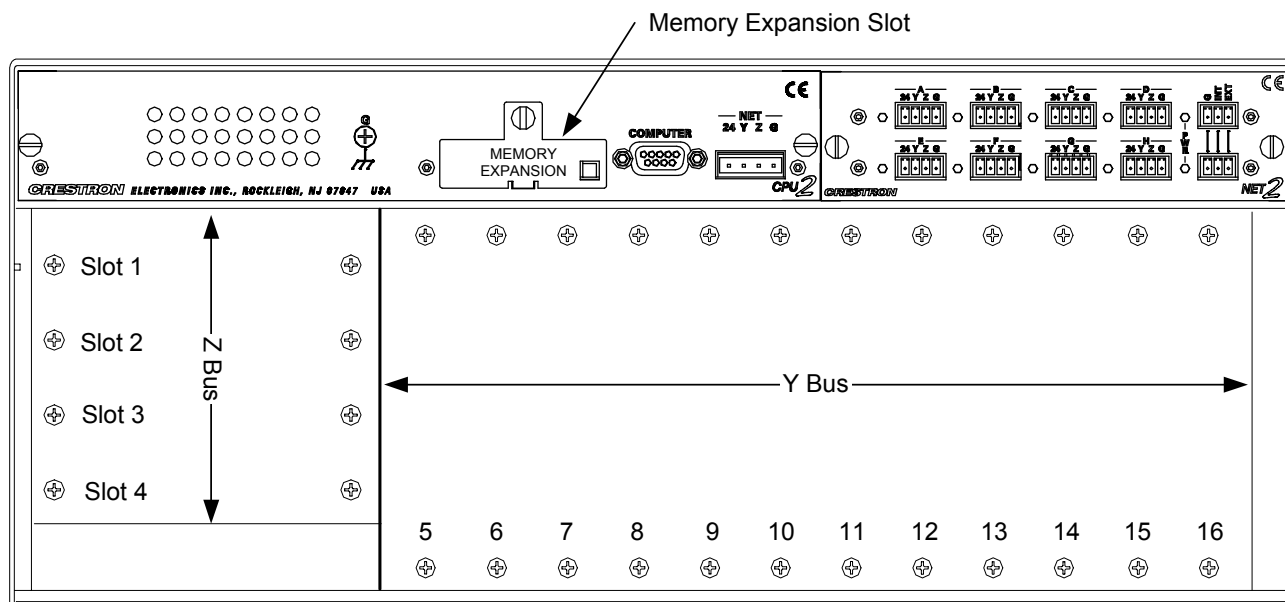

Four rubber feet (supplied) can be affixed to the bottom of the RACK2 to provide stability and to prevent slippage when mounted on a flat surface. The unit may also be rack mounted by attaching metal flanges, known as ears (supplied), to each end.

Expansion Slots

The 16 open card cage slots accept 2-Series and most X-Generation expansion cards. Slots 1 through 4 accept Ethernet Z-Bus cards, either the C2ENET-1 or C2ENET-2. These are network interface cards that connect the 2-Series control system to the Ethernet network. Each of the following cards provides 254 IP IDs for Ethernet devices.

NOTE: Even though four slots are available, only ONE C2ENET card may be installed in slot 1. The remaining three slots (2, 3, and 4) are for future expansion.

- The C2ENET-1 card provides one LAN port with an RJ-45 connector for connecting to the Ethernet network.
- The C2ENET-2 card provides two LAN ports and a network address translator. This allows a private sub-network to be created within a larger LAN. Here the LAN A side of the C2ENET-2 card has one public IP address that is visible to the larger network, while the LAN B side consists of private IP addresses not visible to the larger network. In this way, the sub-network of controlled Ethernet devices can be configured without need to obtain multiple IP addresses from a network administrator or ISP.

Slots 5 through 16 accept X-Generation and 2-Series Y-Bus cards.

NOTE: The X-Generation CNXCOM-2 card is not supported.

RACK2 Ports

There is only one port on the front panel of RACK2, labeled COMPUTER. All of the other ports are on the rear side.

COMPUTER

These 9-pin DB9 female connectors (one on the front panel and one on the rear panel in the CPU2 section) are used when programming the RACK2 with a PC. A standard DB9 female (PC end) to DB9 male (RACK2 end) straight-through serial cable (not supplied) is used to communicate with either COMPUTER port. The ports are electrically connected and are modem compatible. The modem cable is not included.

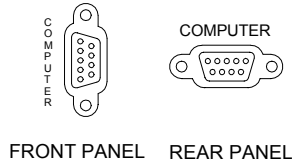

NOTE: For RS-232, pins 2, 3, 5, 7, and 8 are wired straight through. Data Set Ready (DSR) and Data Terminal Ready (DTR) are not supported.

Standard DB9 Pin Assignments

PIN #	ABBREVIATION	DESCRIPTION
1	DCD	Data Carrier Detect
2	RD	Receive Data
3	TD	Transmit Data
4	DTR	Data Terminal Ready
5	SG	Signal Ground
6	DSR	Data Set Ready
7	RTS	Request To Send
8	CTS	Clear To Send
9	Ring	Ring Indicator

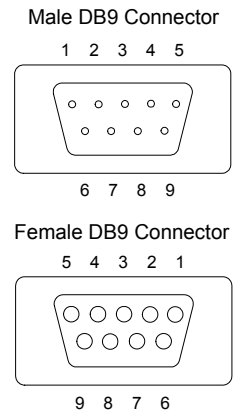

NET

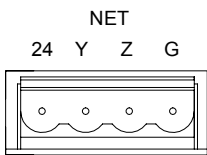

The master Cresnet port on the back of CPU2 is a 4-wire male connector (typical Crestron network port labeled 24 Y Z G), and is used for expansion to Cresnet peripherals and to supply Cresnet (power and control) to the NET2 Cresnet communications hub.

Refer to the NET2 explanation that follows.

Refer to “Network Wiring” on page 19 for additional Cresnet wiring details.

NET2

The NET2 eight 4-pin mini-Cresnet ports, arranged in two rows of four, comprise the Cresnet hub. The Y and Z data lines of all eight ports are wired in parallel to a common packet switching device on the NET2 card. Each group of four connectors (A through D and E through H) is powered by their respective 3-pin mini power connector (PWR) located to the right of each row of connectors.

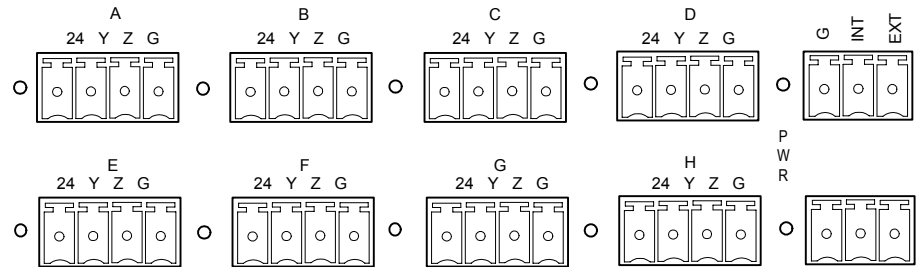

NOTE: Do not operate RACK2 when NET2 is not installed.

The RACK2 system offers a great deal of data and power connection flexibility.

Control Connections

You may choose to control the NET2 hub using the CPU2 or you may use an external control system. Twisted pair wire is recommended for hookup.

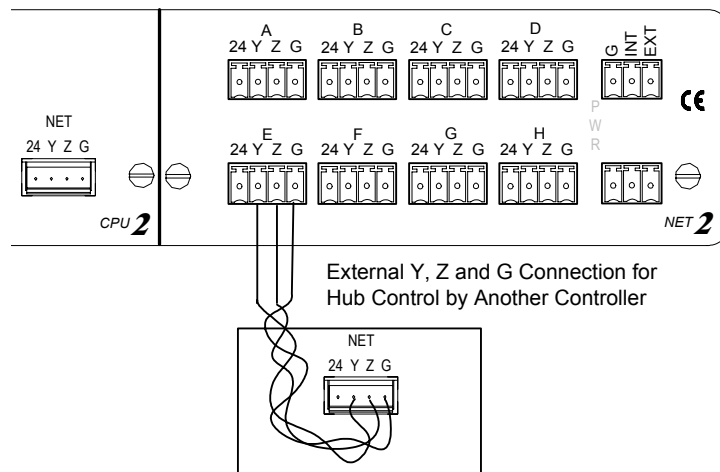
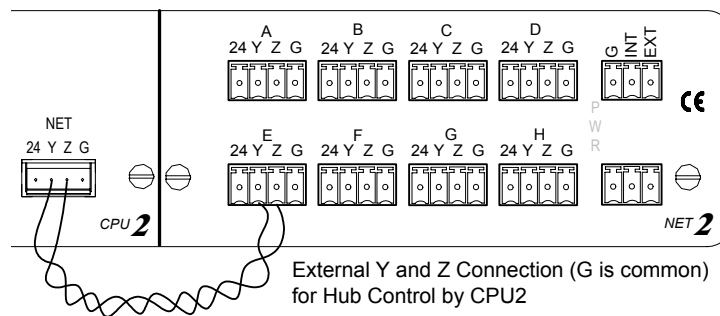

Power Connections

Power from the 24 VDC pin of the NET connector on the CPU2 is internally wired to the INT terminal (24 VDC) of each PWR mini connector.

The G (ground) terminal of the CPU2 NET terminal is internally common to all hub connectors and the CPU2.

The EXT terminal of the PWR mini connector on the NET2 hub is internally wired to the 24 VDC terminals of the mini-Cresnet connectors in each group of four hub ports.

To supply power to the NET2 hub using a CNPWS-75 power supply connected to the NET terminal on CPU2, a jumper is required (supplied) from the INT terminal to the EXT terminal.

Power Connection for the Hub using a CNPWS-75 Connected to CPU2

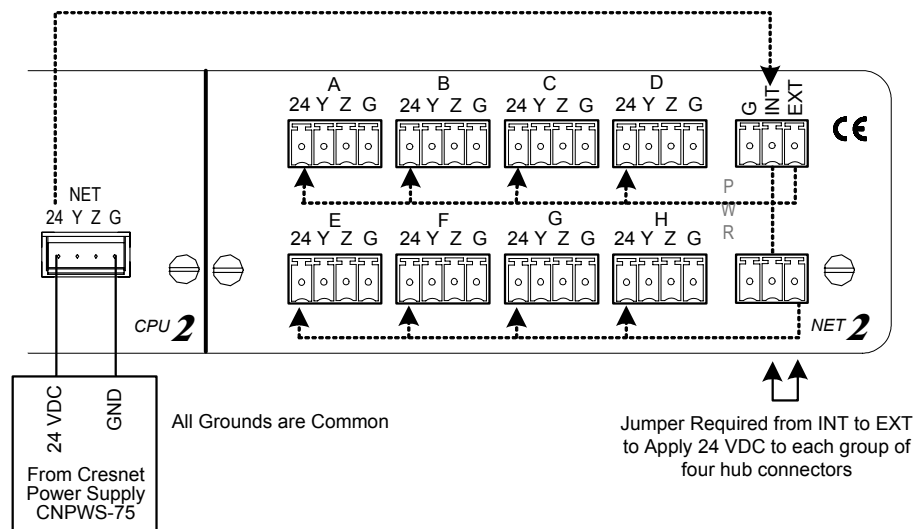

If the power needed for a hub segment exceeds the power available from the power supply (75 watts, max.) connected to the CPU2, remove the jumper from the 3-pin mini connector to disconnect the internal power supply, then connect the (Crestron 24 VDC - regulated power supply) 24 VDC to the EXT terminal and ground to the G terminal.

NOTE: If a device or a Cresnet network connected to a hub segment has its own power source, do not make any connection to the applicable POWER port. Although equipment damage is unlikely, Crestron does not recommend applying two power sources to the same circuit.

Depending on the power requirements, you can connect additional power supplies in the following manner.

- An additional power supply for one group of four hub connectors (using the CPU2 power for the other group of four hub mini-connectors)
- An additional power supply for each group of hub connectors (disconnecting the CPU2 power supply from NET2)

Refer to the following diagram.

Example of External Power Connections for the NET2 Hub – Using an Additional Power Supply for a Group of Four Mini Hub Connectors

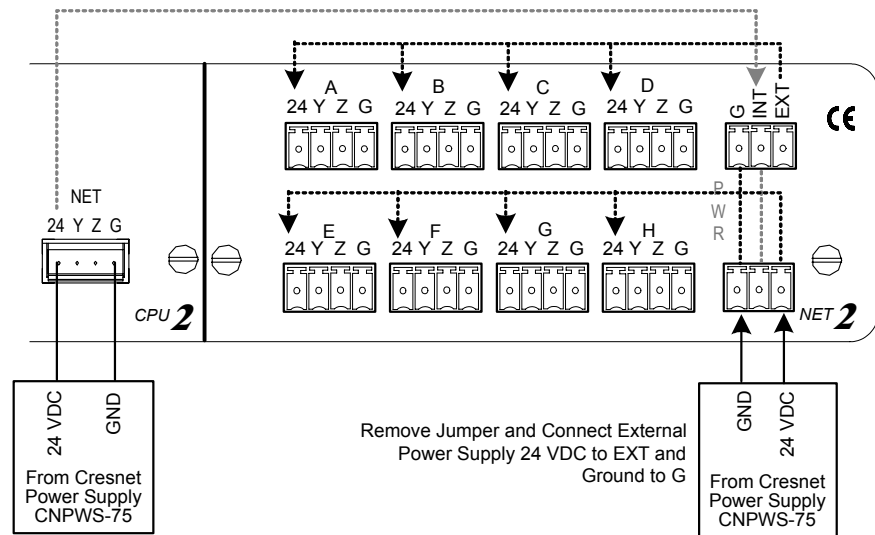

Reset Buttons

Two reset buttons are provided on the front panel of the RACK2.

HW-R

Pressing this button initiates system hardware reset. (Same effect as disconnecting and reconnecting power.)

SW-R

Pressing this button in combination with the **HW-R** button performs a system restart without loading the program (refer to “Troubleshooting Communications” on page 23). Pressing it alone momentarily while the system is running restarts the program.

RACK2 Indicators

There are 23 LED indicators on the front panel of the RACK2 and 10 LED indicators on the rear panel.

PWR

This LED illuminates when the RACK2 receives power from the external power supply (sold separately).

NET

This LED illuminates when the CPU is processing data or communicating with system hardware. Examples include: a button pressed at the local or a network panel, data being sent out of either serial port.

ERR

This LED illuminates when one or more error conditions are detected by CPU2. This may be the result of hardware or software failure, hardware incompatibility with software definitions, a programming error, or a connectivity problem.

To display a list (error log) refer to “MSG” on page 13. The LED extinguishes after the last message has been read.

NOTE: The LAN LEDs are active only if a single port or dual port Ethernet card (which is field installed) occupies a Z-BUS slot.

LNK A, LNK B (LAN)

These LEDs illuminate when the Ethernet card has established a valid Ethernet connection.

ACT A, ACT B (LAN)

These LEDs illuminate when there is communication (activity) at the respective port on the Ethernet card.

INTERFACE CONTROL CARD SLOT (1 – 16)

These LEDs illuminate when an expansion card is present in a respective slot. The LEDs blink when the card is active.

Hub Indicators

The LEDs located to the left of each hub connector indicates activity. The two power (PWR) connectors also have LEDs to indicate when power is applied from the CPU2 or another source.

RACK2 LCD Screen and Buttons

The front panel of the RACK2 incorporates a reverse mode (yellow on black) LCD screen, as shown in the following illustration. The screen contains two lines with up to 40 characters per line; it is used to extend features and gain access to the system including the SIMPL program. To the right of the screen there are four menu selection buttons. These buttons permit the user to navigate through the menus and also to control the backlight brightness of the screen. Below the screen there are six menu function buttons. These buttons offer extended features of the RACK2. Refer to “Programming the LCD Screen” on page 34 for details.

Default LCD Screen with Menu Selection and Menu Function Buttons



Menu Selection Buttons



MENU

This menu selection button functions as a return and will eventually bring the screen display to the menu default state (Main Menu).

These buttons scroll the listed information UP and DOWN.

Menu Function Buttons

BKLT

This button adjusts the brightness of the LCD backlight and the front panel LEDs.

PANEL

NOTE: If the unit does not have a loaded program with front panel screens defined, the PANEL menu function does not appear on the Main Menu.

This menu function button displays a programmable interface offering command text, indirect text, and hierarchical screen structure. The menu contents are subject to programming and an example of this display is provided in "Programming the LCD Screen" on page 34.

INFO

This button displays a default Info Menu, shown in the following figure. System information, including the loaded SIMPL program version (Rems), hardware specs such as types of expansion cards installed in the card slots (HWare), the Cresnet devices detected (Net), the Ops version (Ops), and the communication settings (Com), is displayed.

While the COM menu is displayed, press the Δ or ∇ menu selection buttons to change the system baud rate.

NOTE: The information within each of the commands displayed in the Info Menu may exceed the 40 characters permitted per line. If this occurs, use the two right-most menu function buttons to scroll left and right. Refer to the two arrows shown beneath the Info Menu illustrated after this note for location and identification.

Default Info Menu

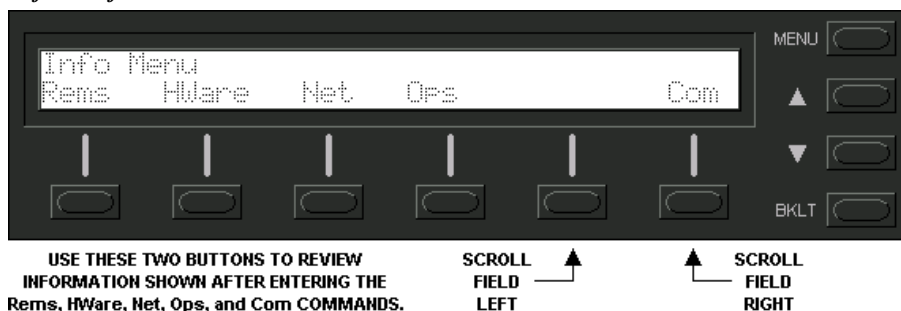

MSG

This button displays a list (error log) of the most recent errors. Error messages may be the result of hardware or software failure, hardware incompatibility with software definitions, or a programming error.

NOTE: Loss of power may cause the error log to clear.

The following table lists and defines the four types of error messages that may appear.

Error Message Types

TYPE	DEFINITION
Notice!	An event has occurred that is noteworthy, but may not affect program operation.
Warning	An event has occurred that could affect program operation, but the program can still run normally.
Error	An event has occurred that indicates that the program is not operating as expected.
Fatal	An event has occurred that will prevent the program from running.

The top line of the LCD screen provides a single error message from the error log. In the sample shown below, the message indicates that the system expects a card to be inserted into slot 1. The bottom line of the LCD screen provides commands. The user can use **NEXT** or **PREV** to scroll through the entire error log. Some messages may be too long to be displayed across the top line of the LCD screen; use << and >> to scroll left and right, respectively, or examine them through Viewport (refer to the following note for a definition of Viewport). Users may wish to periodically save the error log to a file. This can be an invaluable aid in troubleshooting problems with the control system. In Viewport, select **Function | 2-Series | Error Log | Save Error Log to File** and follow the prompts.

The **CLEAR** button can be used to empty the error log and extinguish the ERR front panel LED. A security message prompts the user to confirm the command.

NOTE: The up and down menu selection buttons to the right of the LCD screen may be used in lieu of the **NEXT** and **PREV** menu function buttons.

NOTE: Currently, the Crestron Viewport is available as a pull-down command from SIMPL Windows and Crestron VisionTools® Pro-e (**Tools | Viewport**) and as a standalone application. The Viewport utility performs multiple system tasks, primarily via an RS-232 or TCP/IP connection between the control system and a PC. It is used to observe system processes, upload new operating systems and firmware, change system and network parameters, and communicate with network device consoles and touchpanels, among many other tasks. Viewport can also function as a terminal emulator for generic file transfer. All of these functions are accessed through the commands and options in the Viewport menus.

MSG Submenu with Sample Message



TIME

This menu can only be obtained by entering the correct access code. The default access code is 1234. Use the Viewport (**Functions | Set Front Panel Password**) to assign a unique access code.

The default Date/Time Menu, shown after this paragraph, permits alterations to the current system date and time shown on the top line. Select either Date or Time to open the respective submenu.

Default Date/Time Menu



The Date Set submenu, shown after this paragraph, permits alterations to the current system date, shown on the top line. Use the Dn (down) and Up selection buttons for month, day, and year decremental or incremental changes, respectively.

Date Set Submenu



The Time Set submenu, shown after this paragraph, permits alterations to the current system time, shown on the top line. Use the Dn (down) and Up selection buttons for hour and minute (Min) decremental or incremental changes, respectively. The AM/PM selection button toggles between AM and PM.

Time Set Submenu



COM

This button allows the user to monitor the transmission and reception traffic on a COM-type device and card that is active in the SIMPL Windows program that is loaded into the 2-Series control system. This includes all devices connected via Cresnet (e.g. ST-COM) and Ethernet (e.g. CEN-COM) and cards inserted into the expansion slots (e.g. C2COM-3). Serial transmission to IR ports can also be monitored. Refer to "COM Analyzer" on page 42 for details.

NOTE: Only COM-type devices and cards in the SIMPL Windows program that are active (not commented out) are monitored.

On-Board Memory

The CPU2 has 36MB of built-in memory (non-volatile and volatile). A total of 36MB is broken down as follows: 4MB flash (non-volatile), 32MB DRAM (volatile), and 256KB NVRAM (non-volatile memory). Flash memory contains the file system inside the 2-series control engine. NVRAM contains information that is retained after loss of electrical power. Volatile memory is lost after a power failure. Refer to the lists below for a breakdown of memory usage for program-related information stored in the unit.

Internal Flash

The 4MB flash memory consists of approximately 1.5MB used for firmware, and approximately 2.5MB available for SIMPL, SIMPL+, and web pages. The files that reside in flash conform to a flat directory structure. The following table presents the structure of the overall file system.

File System Structure

TOP LEVEL	SECONDARY LEVEL	DESCRIPTION
\		Root of the file system
	DISPLAY	Legacy/Unused
	SYS	Contain various system configuration files
	SETUP	Directory used to hold setup files
	HTML	Web pages
	SIMPL	Control system program files
	SPLUS	SIMPL+ module files\
	USER	User defined files
	MAILBOX	User mailbox file
	CFØ	The mounting point for the compact flash files.
	\CFØ\DISPLAY	Directory used to hold display files
	\nvram	The mounting point for NVRAM disk files

Although the file system is case insensitive, the case is preserved to maintain file checksums. The compact flash directory only appears when the compact flash is inserted into the system. To reference files on the compact flash, prefix the “\CFØ” to any fully qualified path from the Windows environment. For example, if the file in Windows is “\MyDirectory\MySubdirectory\MyFile.ext”, the complete 2-Series path for a file on the first Compact Flash slot (onboard) is:

```
“\CFØ\MyDirectory\MySubdirectory\MyFile.ext”
```

You do not have to create subdirectories for general files; you can put them in the root of the Compact flash (\CFØ).

The only time subdirectories are required is when putting bootable projects on the Compact Flash (\CFØ\SIMPL, \CFØ\SPLUS), but SIMPL Windows takes care of that for you when you do the File | Copy to CF function. SIMPL Windows makes the appropriate subdirectories. The same is true when you put web pages on the Compact Flash. The tools create the appropriate directories.

Non-volatile

1. SIMPL+ Variables (Default if no options are specified, or using "nonvolatile" qualifier or #DEFAULT_NONVOLATILE)
2. Signals explicitly written to NVRAM* (by symbols such as Analog RAM, Analog RAM from database, Serial RAM, Serial RAM from database, Analog Non-volatile Ramp, Digital RAM, etc.)
*Commonly used for presets (volume/lighting/dial #s).
3. Portions of the NVRAM may be set aside for implementing an "NVRAM Disk". This can be used to provide file system access from SIMPL+.

NOTE: If you extract NVRAM values to a file (**Viewport, File transfer | Save NVRAM to File**), to simplify restoring them in the event of file corruption or to distribute to identical control systems, remember that NVRAM values are position sensitive in the program. When saving the NVRAM is crucial to your application, it is recommended to place all symbols and/or modules that use NVRAM at the beginning of your program. When NVRAM (.nvr file) is re-installed, all the values should line up with the program. If the program is modified, and new logic that uses NVRAM is placed before any older symbols using NVRAM, the previously stored values will not line up and your presets will have to be re-entered.

NOTE: The new NVRAMDISK command (available in CUZ files later than 3.030), will fail unless it can determine the amount of NVRAM used by the program, to ensure that the NVRAM is not overwritten. Programs compiled in SIMPL Windows version 2.04.11 or later can provide this information. In the event of a failure of the NVRAMDISK command, ensure that your program has been recompiled in an appropriate version of SIMPL Windows and reloaded.

Volatile

1. Digital, analog and serial signal values
2. SIMPL+ Variables (if "volatile" qualifier is used, or #DEFAULT_VOLATILE is used)

DRAM

DRAM is used by the operating system for dynamic storage of variables, signals and other constructs used at runtime. The actual amount of DRAM used at any given time depends on the particular program that is running, i.e., usage is variable, or dynamic, during normal operation.

Expandable Memory (Compact Flash)

The onboard 36MB memory of the 2-Series integrated dual bus control system is enhanced with a 4GB expansion slot that supports off-the-shelf Type II compact flash memory and the IBM Microdrive[®] hard drive. The slot is accessible on the rear panel of the unit. Complete the procedures in the following subsections to install and remove the memory cards. Power does not have to be disconnected to insert or remove memory. Note that compact flash memory supports FAT32 file structure.

Memory Card Installation

1. Loosen the screw that secures the memory slot cover located on the rear panel.
2. Pull on the screw to remove the screw and cover.
3. Observe handling precautions of the memory card manufacturer and insert into the open slot.
4. Align and reposition cover over slot and tighten the screw.

Memory Card Removal

1. Loosen the screw that secures the memory slot cover located on the rear panel.
2. Pull on the screw to remove the screw and cover.
3. Press the eject button located on the extreme right of the slot.
4. Observe handling precautions of the memory card manufacturer and remove card from the slot.
5. Align and reposition cover over slot and tighten the screw.

Industry Compliance

As of the date of manufacture, this unit has been tested and found to comply with specifications for CE marking and standards per EMC and Radiocommunications Compliance Labelling (N11785).



NOTE: This device complies with part 15 of the FCC rules. Operation is subject to the following two conditions: (1) this device may not cause harmful interference, and (2) this device must accept any interference received, including interference that may cause undesired operation.

Setup

Rack Mounting

WARNING: To prevent bodily injury when mounting or servicing this unit in a rack, you must take special precautions to ensure that the system remains stable. The following guidelines are provided to ensure your safety:

- The unit should be mounted at the bottom of the rack if it is the only unit in the rack.
- When mounting this unit in a partially filled rack, load the rack from the bottom to the top with the heaviest component at the bottom of the rack.
- If the rack is provided with stabilizing devices, install the stabilizers before mounting or servicing the unit in the rack.

NOTE: If rack mounting is not required, rubber feet are provided for tabletop mounting or stacking. On the underside of the unit, apply two of the feet at the rear corners and the remaining two approximately one inch from the front corners.

NOTE: Reliable grounding of rack-mounted equipment should be maintained. Particular attention should be given to supply connections other than direct connections to the branch circuit. (e.g., use of power strips).

NOTE: For proper ventilation, allow four rack spaces when mounting.

Two “rack ears” are provided with the RACK2 so that the unit can be rack mounted. These ears must be installed prior to mounting. Complete the procedure below to attach ears to RACK2 using a Phillips screwdriver.

1. At the left-front side of the unit, position a rack ear so that its drilled holes align with the four unused holes and secure the ear with four supplied #6-32 screws, as shown below.

Ear Attachment for Rack Mounting

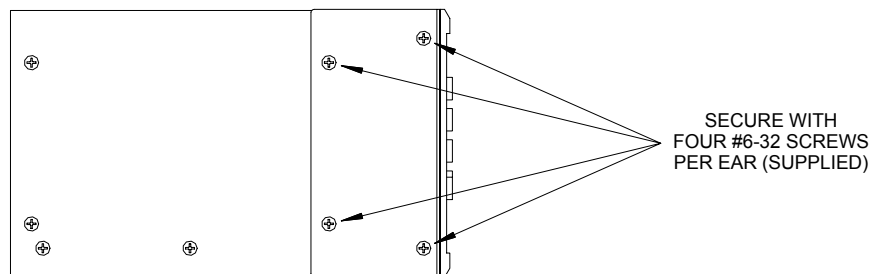

2. Repeat step 1 of this procedure to attach the remaining ear to the right-front side.

Network Wiring

CAUTION: Possible equipment damage if miswired.

NOTE: When installing network wiring, refer to the latest revision of the wiring diagram(s) appropriate to your specific system configuration, available from the Downloads | Product Manuals | Wiring Diagrams section of the Crestron website (www.crestron.com).

NOTE: Do not power up system until all wiring is verified. Care should be taken to ensure data (Y, Z) and power (24, G) connections are not crossed.

When calculating the wire gauge for a particular network run, the length of the run and the power factor of each network unit to be connected must be taken into consideration. If network units are to be daisy-chained on the run, the power factor of each network unit to be daisy-chained must be added together to determine the power factor of the entire chain. The length of the run in feet and the power factor of the run should be used in the following resistance equation to calculate the value on the right side of the equation.

Resistance Equation

$$R < \frac{40,000}{L \times PF}$$

Where: R = Resistance (refer to table below).
 L = Length of run (or chain) in feet.
 PF = Power factor of entire run (or chain).

The required wire gauge should be chosen such that the resistance value is less than the value calculated in the resistance equation. Refer to the table after this paragraph.

Wire Gauge Values

RESISTANCE (R)	WIRE GAUGE
4	16
6	18
10	20
15	22
13	Doubled CAT5
8.7	Tripled CAT5

NOTE: All network wiring must consist of two twisted-pairs. One twisted pair is the +24V conductor and the GND conductor and the other twisted pair is the Y conductor and the Z conductor.

NOTE: When daisy chaining network units, always twist the ends of the incoming wire and outgoing wire that share a pin on the network connector. After twisting the ends, tin the twisted connection with solder. Apply solder only to the ends of the twisted wires. Avoid tinning too far up or the tinned end becomes brittle and breaks. After tinning the twisted ends, insert the tinned connection into the network connector and tighten the retaining screw. Repeat the procedure for the other three network conductors.

Hardware Hookup

Refer to the following hookup diagram. Aside from connecting power last, complete the connections in any order. The serial cable to the PC may be attached to the DB9 connector of CPU2 on the rear panel or to the DB9 connector on the RACK2 front panel. Use the front panel or rear panel connector for setup and programming.

CAUTION: To prevent overheating, do not operate this product in an area that exceeds the recommended ambient temperature of 113°F (45°C). Consideration must be given if installed in a closed or multi-unit rack assembly since the operating ambient temperature of the rack environment may be greater than the room ambient. Contact with thermal insulating materials should be avoided on all sides of the unit.

NOTE: The maximum continuous current from equipment under any external load conditions shall not exceed a current limit that is suitable for the minimum wire gauge used in interconnecting cables. The ratings on the connecting unit's supply input should be considered to prevent overloading the wiring.

Hookup Connections for RACK2

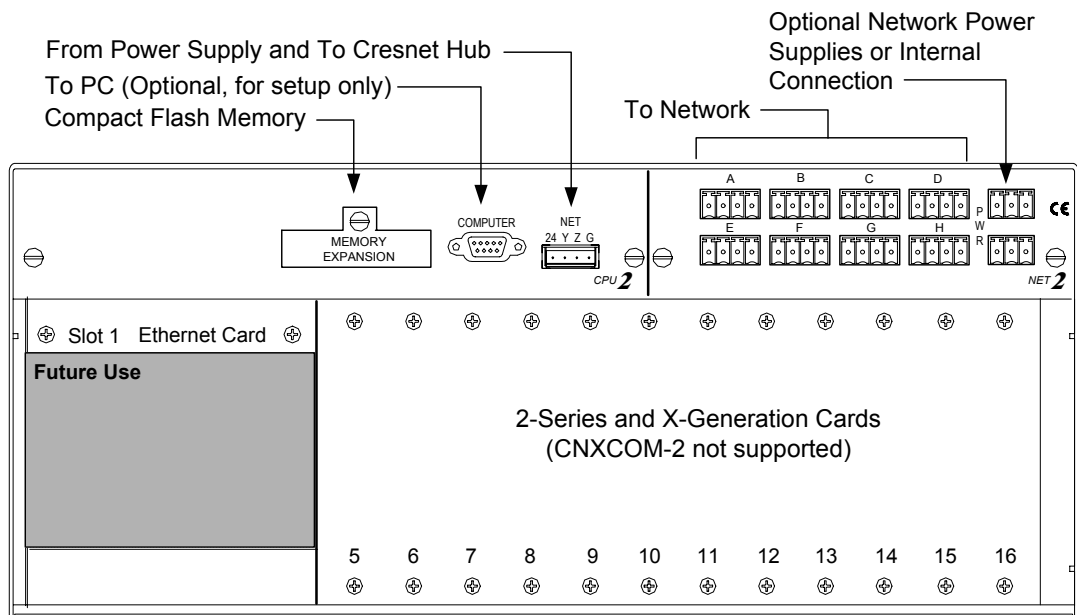

Establishing Communication with the RACK2

Before uploading a program or performing diagnostic functions, you must connect the control system to the PC. This connection can be serial or (if an optional Z-Bus card is installed) it can be TCP/IP.

Serial Connection

NOTE: For laptops and other PCs without a built-in RS-232 port, Crestron recommends the use of PCMCIA cards, rather than USB-to-serial adapters. If a USB-to-serial adapter must be used, Crestron has tested the following devices with good results:

- Belkin (large model) F5U103
- I/O Gear GUC232A
- Keyspan USA-19QW

Other models, even from the same manufacturer, may not yield the same results.

Connect the COMPUTER port on the control system to one of the COM ports (usually COM 1) on the PC. Use a straight-through RS-232 cable with a DB9 male connector on one end and a DB9 female connector on the other. Most commercially available cables are acceptable; they should have at least five pins for transmit, receive, ground, and hardware handshaking (pins 2, 3, 5, 7, and 8).

Open the Crestron Viewport and click **Setup | Communication Settings** to display the “Port Settings” window. Then click **RS-232** as the connection type.

The PC communication settings specified here should match the protocol that the RACK2 expects. The settings are as follows:

- Port = COM 1 through COM 8. Select the correct COM port on the PC.

- Baud rate = 115200 (You can set the PC and the control system to a different baud rate, by using the **Functions | Set Baud Rate** command).
- Parity = None.
- Number of data bits = 8.
- Number of stop bits = 1.
- Hardware handshaking (RTS/CTS) enabled.
- Software handshaking (XON/XOFF) not enabled.

“Port Settings” Window: Default PC Settings for RS-232 Communication with the RACK2.

To verify communication, click **Diagnostics | Establish Communications (Find Rack)**. This should display a window that gives the COM port and baud rate.

TCP/IP Connection

Before you can communicate with the RACK2 over TCP/IP, you must use the RS-232 connection just described to configure the unit’s TCP/IP settings. You must also have one optional Ethernet card (C2ENET-1 or C2ENET-2) installed in Z-Bus slot 1.

1. Open Viewport and click **Functions | Set Control System IP Information**.
2. Enter the IP address, IP mask and default router in the text fields. All of these terms are explained in detail in the Crestron e-Control Reference Guide (Doc. 6052). The latest version is available as a PDF on the Crestron website (www.crestron.com).
3. Click **OK** to set the new IP information.

Once you have assigned the IP settings, you can continue to communicate with the RACK2 using the RS-232 connection, or you can establish a TCP/IP connection.

For TCP/IP, use CAT5 straight through cables with 8-pin RJ45 connectors to connect the LAN port on the RACK2 and the LAN port on the PC to the Ethernet hub. Alternatively, you can use a CAT5 crossover cable to connect the two LAN

ports directly, without using a hub. The following figure illustrates pinouts for straight through and crossover RJ45 cables. Pins 4, 5, 7, and 8 are not used.

RJ45 Pinouts

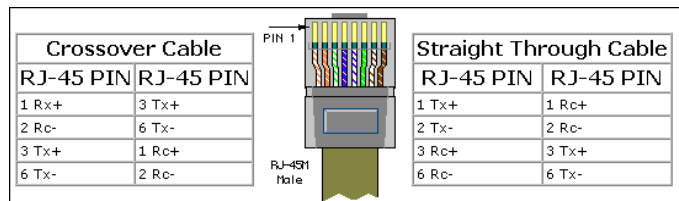

Once the cable connections are made, open the Crestron Viewport and click **Setup | Communication Settings** on the menu to display the “Port Settings” window. Then click **TCP/IP** as the connection type. Enter the IP address of the RACK2.

“Port Settings” Window

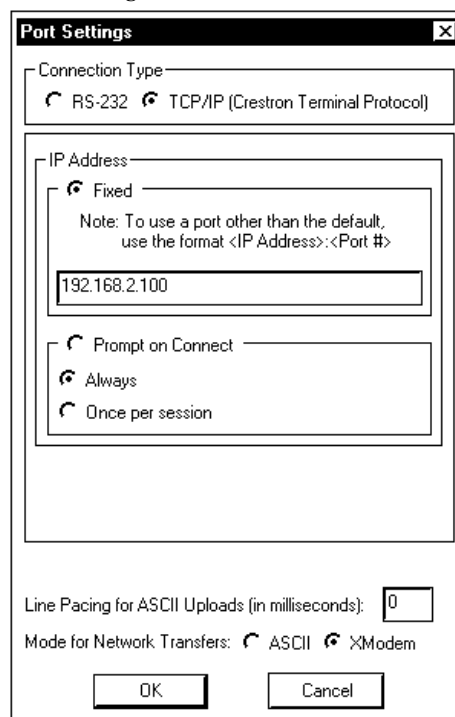

To verify communication, click **Diagnostics | Establish Communications (Find Rack)**. This should display a window that gives the IP address and port number.

Troubleshooting Communications

Use the following checklist if communication cannot be established with the RACK2.

1. Verify that you are using the correct cables. As described previously, an RS-232 connection requires a straight-through serial cable. That is, pin 1 on one end is connected to pin 1 on the other end. Pin 2 connects to pin 2, etc. With a TCP/IP connection, you must use a CAT5 cable with 8-pin RJ45 connectors.
2. With a serial connection, verify that the correct COM port on the PC has been selected. Some computers have more than one COM port;

some may be internal (e.g., for a modem). Consult the manufacturer's documentation for further information about the COM ports on your PC.

3. Check the **ERR** LED indicator on the front panel of the RACK2. If this LED is illuminated, unplug the unit and reapply power after a few seconds. If the LED illuminates again, call Crestron customer service.
4. With a serial connection, reset the control system as follows:
 - a. Open Viewport and click **Setup | Communications Settings** to display the "Port Settings" window. Choose **RS-232** as the connection type.
 - b. Set the baud rate of the PC to **115200**.
 - c. Set the baud rate of the RACK2 control system to 115200, as follows:
 - Press and release the **HWR** button on the unit's front panel.
 - Press and hold the **SWR** button for approximately three to five seconds. The Viewport console should display the following message:

Viewport Message

```
RACK2>
Control Console
Changing to default Comm Specs. 115200 N81 RTS/CTS
Switch to new settings. . .
Bypassing Program Load!!!!
```

- Release the **SWR** button.
- d. If communication still cannot be established:
 - Remove power from the control system.
 - Press and hold the **SWR** button on the front panel of the RACK2.
 - Reapply power to the control system.
 - The Viewport console should display the message shown above.
 - Release the **SWR** button.
 - e. Select **Set Baud Rate** on the Viewport **Functions** menu (or press **F8**) and choose any baud rate from the drop-down list. This will attempt to establish a connection at the indicated baud rate. If the connection is successful, both the PC and the control system will be set to the new baud rate.
 - f. Reinitialize the unit by recycling the power or pressing the **HWR** button. If the connection is established, the Viewport console should display some text and the **<RACK2>** prompt.
 - g. If communication still cannot be established, contact Crestron customer service.

Compiling and Uploading a Program to the Control System

After you have completed your SIMPL Windows program you must compile and upload the program to the control system.

To compile the program, simply click the **Convert/Compile** button  on the SIMPL Windows toolbar, or select **Project | Convert/Compile** (you can also press **F12**). A status bar will indicate the progress of the compile operation. After the operation is complete, a window will display information about the program such as the number and type of signals, and memory usage.

The compiled program will be stored as an SPZ file in the same directory as the source file. There are a number of ways to upload an SPZ file to the control system.

1. Immediately after compiling the program you have the option to transfer the file to the control system.
2. Alternatively, click the **Transfer** button  on the SIMPL Windows toolbar, or open Viewport and click **File Transfer | Send Program**.
3. Click **Browse**, locate the SPZ file and click **Open**. This will display the program's header information and enable one or both of the *What to Send* check boxes. If the program does not contain any SIMPL+ modules, only the *SIMPL Program* check box will be enabled. If it does contain SIMPL+ modules, then the *SIMPL+ program(s)* check box will also be enabled. Select one or both check boxes and then click **Send Program** to begin the transfer.

NOTE: Unlike X-Generation processors, the 2-Series processor does not require a permanent memory image. Also, the 2-Series adds the ability to automatically retrieve the current program from the control system. Simply verify that the *Retrieve Current Program Before Overwriting* check box is selected.

Choose where the program will be sent: **Internal Flash** or **Compact Flash**. (With the Compact Flash option, if the Viewport does not detect a Compact Flash card, you will be prompted to insert a card and retry the upload procedure.) The 2-Series processor also provides the option to retrieve the current program from internal or Compact Flash memory before overwriting it. Simply select the **Retrieve Current Program** check box and specify the filename and directory.

The **Retrieve Program** command copies the current program from either internal or Compact Flash to disk. If the Viewport detects a program in Compact Flash, the following window will be displayed:

Retrieve Program Window

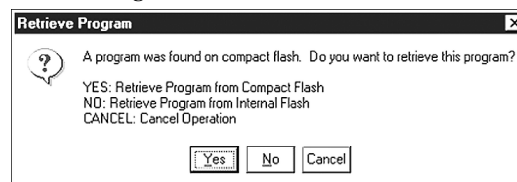

As shown above, click **Yes** to retrieve the program from Compact Flash, or **No** to retrieve the program from internal memory. Click **Cancel** to cancel the operation.

When a program is uploaded, that program's filename is added to the **New Program** drop-down list. This makes it convenient to reload frequently used programs, as they can be selected from the list without need to browse to a directory. To delete the list, click **Clear History**.

You can also click **Check Program** to display the header information of the currently loaded program.

“Send Program” Window

Another way to verify that the program has been transferred successfully is to select **Report Program Information** on the Viewport **Diagnostics** menu. Program information is also displayed in the Viewport console whenever power is removed and re-applied to the RACK2.

Uploading Web Pages to the RACK2

NOTE: The Crestron default web host port is 80. Port 80 requires port 41794 to communicate to the SIMPL program.

The RACK2 provides a built-in Web server for e-Control applications. The RACK2 allots 2.5 MB of memory for “user files” such as web pages, mailbox, and the compiled SPZ file. For detailed information, refer to “Uploading Web Pages” in the Crestron e-Control Reference Guide (Doc. 6052). The latest version is available as a PDF on the Crestron website (www.crestron.com).

NOTE: If you have a Compact Flash reader/writer drive on your PC, you can load HTML pages to a Compact Flash card using Windows Explorer or any other file transfer method. When the card is inserted into the Memory Expansion slot of the control system, the web pages will be recognized as valid for e-Control so long as they are located in a directory called **HTML**. (The **HTML** directory must also include a configuration file called `_config_ini_`, which identifies the default page—contact Crestron for further information.)

NOTE: For IP setup information, refer to the Operation & Installation Guide for the 2-Series Ethernet Interface Expansion Cards: C2ENET-1 & C2ENET-2 (Doc. 5962). The latest version is available as a PDF on the Crestron website (www.crestron.com).

Uploading Touchpanel Projects via the RACK2

You can use a connection to the RACK2 to upload Crestron VisionTools® Pro-e (VT Pro-e) projects to any Cresnet touchpanel. Compiled projects for TPS panels are contained in VTZ files; projects for all other touchpanels are contained in HEX files.

Before uploading, open Viewport and click **Diagnostics | Report Network Devices** to verify that the touchpanel is being detected by the control system. (As with any network device, touchpanels must be identified by unique hexadecimal network IDs. These IDs are set in the SIMPL Windows program.)

To upload a project:

1. From VT Pro-e: Click the **Project | Upload** button  on the toolbar, or click **File | Upload Project**.

From Viewport: Click **File Transfer | Send Touchpanel** or press **Alt+T**.

2. Select the network ID of the touchpanel, as set in SIMPL Windows, from the drop-down list.
3. Browse to the HEX or VTZ file to be uploaded. If the file is a HEX file, click **Open** to begin the transfer.

If the file is a VTZ file, choose the pages to send to the TPS panel. The choices are as follows:

- **All Files in Project**: sends the entire project.
- **Only Changed Files**: sends only the files that are different from those that are currently stored in the panel. Note that if any pages in the panel are not present in the project, those pages will be deleted from the panel.
- Additional choices include **Do not send graphic files** and **Do not send sound files**. These are often very large files that need not be reloaded with every transfer.

Updating the Operating System

As with all 2-Series control systems, operating system files for the RACK2 have a .cuz extension. You can obtain .cuz updates (when available) from the Software Downloads section of the Crestron website. To download an update, click the .cuz file and choose the **Save to Disk** option, then specify the directory where the update will be stored.

NOTE: In some cases Microsoft's Internet Explorer may append a .zip extension to a downloaded .cuz file. For example, a file called "C2-1008.cuz" may appear as "C2-1008.cuz.zip." If this happens, rename the file, removing the .zip extension.

To upload the new .cuz to the control system:

1. Open Viewport and select **File | Update Control System**.
2. Browse to the .cuz file and click **Open** to start the transfer.
3. After the transfer is complete, the RACK2 will automatically reboot. To confirm the transfer, click **Diagnostics | Check Ops Version**. The Viewport console should display the new .cuz version number.

Running Programs From Compact Flash

On power-up or a hardware reset (**HW-R**), the control system first checks for a program on compact flash and then internal flash. The console command **CFAUTORUN** controls the actions of the control system when a compact flash is inserted into a running system. If **CFAUTORUN** is enabled, when a compact flash card is inserted or removed from the system, the system automatically performs a program reset (**SW-R**) and the boot order described above is used to find the program to run. If **CFAUTORUN** is disabled, then the user must either press the **SW-R** button on the front panel or issue a program reset through the Viewport to switch programs.

Other Compact Flash Related Functions

In addition to the previous topics that are impacted by compact flash availability, other Viewport command functions-including Erase Program, Erase Web Pages, and Send Generic Files-permit you to choose between internal flash and compact flash when selecting programs/files for processing.

A new SIMPL Windows command **File | Copy Output to Compact Flash** copies a compiled SIMPL Windows program (SPZ) file to a compact flash reader/writer on a PC. Click **Browse** to locate the SPZ file; select the drive letter of the CF reader/writer from the drop-down list. Click **OK** to copy the file.

Advanced Console Commands

The SIMPL Windows online help file provides a full listing of console commands that are valid for **2-Series** control systems. You can access the RACK2 console in a variety of ways: via a serial connection (RS-232) with a PC, over Ethernet via the LAN port, or through Telnet, among many other methods. It is also possible to issue console commands through logic, by adding a Console symbol to the SIMPL Windows program.

The Console symbol is only visible in the *Symbol Library* when “Special” is selected as the Symbol Set. Click **Edit | Preferences**. In the *Symbol Set* area of the *General* tab, select **Special** as shown in the following illustration.

"SIMPL Windows Preferences" Window

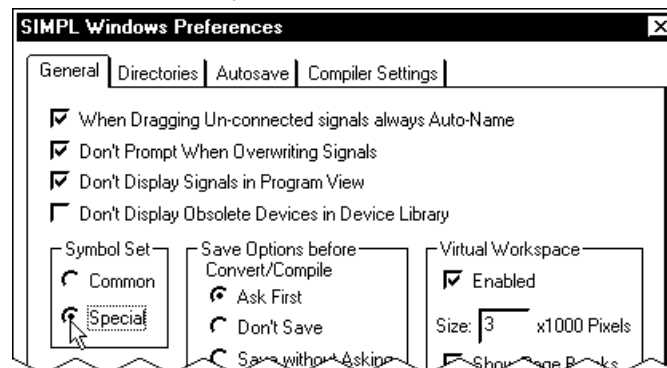

Console commands are provided for advanced programmers. However, most functions and commands can be selected from the various Viewport menus.

NOTE: For more information on console commands, refer to the 2-Series Console Commands Reference Guide, (latest version of DOC. 6002) available from the Downloads | Product Manuals section of the Crestron website (www.crestron.com).

Console Commands for Compact Flash

The following commands have been added to enable processing functions for compact flash files/programs:

CFAUTORUN - Enable the program to autoboot from compact flash.

CFPROJDIRS - Display a list of project directories on compact flash.

CFTRANSFER - Transfer a project to/from compact flash.

MAKEDIR - Create a file directory on compact flash.

REMOVEDIR - Remove a file directory on compact flash.

Console Commands That Work With Compact Flash

The following commands have been modified to enable processing functions for compact flash files/programs:

CD - Permits changing to a directory on compact flash

DELETE - Enables deleting files from compact flash.

DIR - Permits listing files on compact flash.

FREE - If current directory is on compact flash, gives the amount of space available on the compact flash. If internal, gives the amount left on internal flash.

TYPE – Enables display of files residing on compact flash.

XGETFILE – Enables retrieving a file from compact flash.

XPUTFILE – Enables sending a file to compact flash.

Programming

You create a control program for the RACK2 using Crestron programming tools Crestron Application Builder™ (AppBuilder) and SIMPL Windows. You can begin programming using the easiest method (Crestron AppBuilder) and use the advanced techniques available in SIMPL Windows to customize your project. The flexibility of each of these tools is proportional to the degree of programming expertise (i.e., greater flexibility requires more knowledge).

Following are the minimum software requirements for the PC:

- SIMPL Windows version 2.04.11 or later, with Library Update 225 (also requires SIMPL+ Cross Compiler).
- Crestron Database version 15.9.6 or later.
- (Optional) Crestron VisionTools Pro-e software for designing touchpanel pages.
- (Optional) Crestron Application Builder version 1.1.8 software for automatic residential and commercial programming.

The easiest method of programming, but does not offer as much flexibility as SIMPL Windows.

Programming with the Crestron AppBuilder

The Crestron AppBuilder offers automatic programming for such residential and commercial applications as audio distribution, home theater, video conferencing, and lighting. The interface of this tool guides you through a few basic steps for designating rooms and specifying the control system, touchpanels, devices, and functionality. The Crestron AppBuilder then programs the system, including all touchpanel projects and control system logic.

The Crestron AppBuilder is fully integrated with Crestron's suite of software development tools, including SIMPL Windows, VT Pro-e, Crestron Database, User IR Database, and User Modules Directory. The Crestron AppBuilder accesses these tools behind the scenes, enabling you to easily create robust systems.

Programming with SIMPL Windows

SIMPL Windows is Crestron's graphical, Windows-based development tool for programming control systems. The SIMPL Windows interface provides two workspaces: the Configuration Manager, for configuring the control system, touchpanels, and controlled network devices; and Program Manager, for designing the logic and functionality of the control system.

In addition, you can use Crestron's powerful Viewport utility to accomplish multiple system tasks, such as uploading the program to the control system and performing diagnostic functions. Together with the Crestron Database, these tools provide you with the essential components you need to program the RACK2. Crestron software can be downloaded from the Crestron website (www.crestron.com)—registration is required for downloading.

NOTE: The information in this section assumes that the reader has knowledge of SIMPL Windows. If not, refer to the extensive help information provided with the software.

RACK2 Device Library Symbols

In Configuration Manager, drag the RACK2 from the Control Systems folder of the *Device Library* to *System Views*. Refer to the following illustration.

System Views of the RACK2

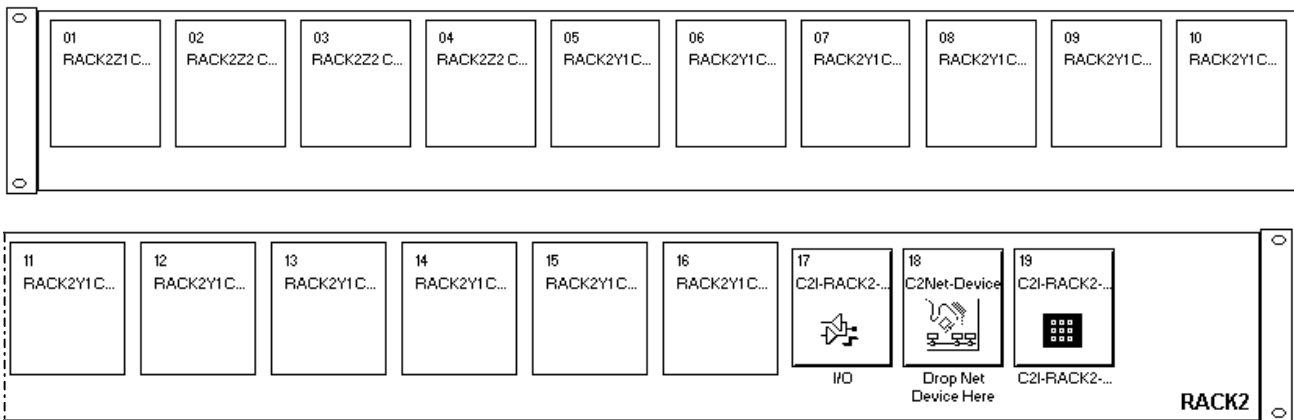

Slots 1 through 4: C2Z Card Slots

The Z-Bus slots enable the addition of 10/100 Ethernet applications.

NOTE: Currently, only one C2ENET card is allowed in slot 1. Other Z-Bus cards will be available in the future.

To prepare for communicating with other devices via the Z-Bus port using a C2ENET-1 or -2 card, you must set up an IP table to identify the IP address and port ID for each of those devices. For detailed information, refer to “Creating an IP Table” in the Crestron e-Control Reference Guide (Doc. 6052). The latest version is available as a PDF on the Crestron website (www.crestron.com).

Slots 5 through 16: C2Y Card Slots

The Y-Bus slots support existing CNX and 2-Series control cards (except the X-Generation CNXCOM-2 card) and permits adding multiple IR, serial communications, and/or relay ports to the control system.

Slot 17: C2I-RACK2-HUB

This slot is a representation of the Cresnet Hub Card NET2. No programming is required.

Slot 18: C2Net-Device

The C2Net-Device slot enables the RACK2 to control up to 252 Cresnet devices. Each Cresnet device is assigned a unique identifier called a Net ID, which is a hexadecimal value ranging from 03 to FE.

To view the list of supported devices, expand the control system in the bottom pane of *System Views* and double-click the C2Net-Device slot, or right-click and select **Add Item** from the submenu. Supported devices include network control modules, lighting modules and a variety of Crestron wired touchpanels.

To add a device to the system expand the C2 Net-Device slot and double-click the desired Net ID, or right click and select **Add Item** from the submenu. Then select the device you want to add. Alternatively, you can drag the device from the Cresnet Modules folder onto the Net ID.

In Program Manager, the C2Net-Device symbol contains no signals; to program a controlled Cresnet device, expand the C2Net-Device symbol in *Program View*. Then drag the device to *Detail View*.

Slot 19: C-2I-RACK2-LCDPANEL RACK2 Front Panel

The front panel symbol has digital analog and serial inputs and digital button press outputs to allow the user to program the logic for the built-in LCD panel.

- Button presses: <press1> through <press999>
- For each button press, one corresponding digital feedback signal <fb1> through <fb999>
- Analog feedback: <an_fb1> through <an_fb256>
- Serials: <text-01> through <text-0127>

The C2I Front Panel symbol programs the push buttons and LCD display on the front panel of the RACK2 control system. The symbol detail is similar to that of a

standard touchpanel, except that the C2I Front Panel is designed using the SIMPL Windows Front Panel Editor rather than the VT Pro-e software.

Like VT Pro-e, the Front Panel Editor provides a number of programmable objects such as the buttons, gauges and text. Pages are also programmable.

Programmable objects are assigned join numbers that identify digital, analog and serial inputs and outputs to the C2I Front Panel. When the front panel design is finished and all join numbers have been assigned to programmable objects, the join numbers then have to be mapped to inputs and outputs on the C2I Front Panel symbol detail.

SIMPL Windows provides an option to automatically define the C2I Front Panel symbol detail: simply click **Synchronize Signals Names** on the Panel menu of the Front Panel Editor.

Front Panel Symbol Displayed in SIMPL Windows - Detail View of Programming Manager

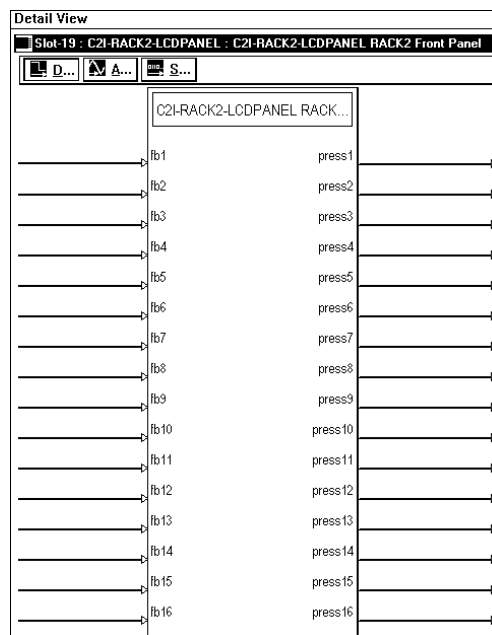

Front Panel Status (Dual Ethernet + Brightness)

The Front Panel Status (Dual Ethernet + Brightness) symbol is a device extender for the C2I Front Panel slot of 2-Series control systems. It is available only to control systems that accept the C2ENET-2 Ethernet card and which provide standard 2-Series error logging capabilities.

The Front Panel Status (Dual Ethernet + Brightness) symbol reports the status of the LAN A and LAN B LEDs on the front panel of the control system; that is, when an LED is on, the corresponding <Link> output goes high. When the LED is off, that <Link> output goes low.

Similarly, the <Err_LED> output goes high when the Error LED is on.

The Front Panel Status (Dual Ethernet + Brightness) symbol can also control the brightness of the LCD display, where <Bright_1> sets the brightness to the lowest setting and <Bright_4> sets it to the highest setting. Another way to change the brightness is to press the BKLT push button on the front panel itself.

The <Bright_FB> outputs report the current brightness setting.

Converting Programs and Modules Created for Other Systems

A useful feature of SIMPL Windows is that you can convert a program created for another type of control system, simply by changing the target to a RACK2.

To do this you first open the program, and then replace the existing control system with the RACK2. That is, drag the RACK2 from the Control Systems folder onto the existing control system in *System Views*, and click **Yes** when prompted to confirm the replacement.

If the program contains SIMPL+ or User modules, the conversion might generate error messages. This is because modules and programs often contain symbols with “ambiguous” signals. For example, the inputs of the Serial to Analog symbol can be defined as either analog or serial. Although X-Generation processors support ambiguous signals, the 2-Series processor requires all signal types to be strictly defined.

If the program you want to convert contains SIMPL+ or User modules, Crestron recommends that you first convert each module before converting the larger program. In this way, the compiler can resolve any ambiguous signals in the modules and minimize errors when the larger program is converted.

Converting SIMPL+ Modules

1. Open the SIMPL+ module you want to convert.
2. Choose the 2-Series processor as the target by clicking the toolbar button, as shown in the following illustration.

SIMPL+ Toolbar



NOTE: You can select both X and 2-Series as the targets, so that the module will work for both control system types. However, you will be limited to SIMPL+ keywords and functions that are supported on both systems. If you do not choose a target, then the module may or may not work, depending on the constructs that are used.

3. Save and compile the module by clicking the **Save and Compile** toolbar button; alternatively, click **Save and Compile** on the **Build** menu (or press **F12**).

Converting User Modules

1. Open the User module you want to convert.
2. Click **Project | Edit Program Header**.
3. Click **2-Series** in the *Target Control System Classes* list box.

You can select other types of control systems as well, but then you will be limited to symbols that are supported by all of these platforms. The module may still work on unselected control systems so long as unsupported symbols are not used. Selecting a control system means that you are *requiring* the module to work there.

“Module Header Information” Window

The screenshot shows a window titled "Module Header Information". It contains the following fields and sections:

- Module Hint: [Empty text box]
- Dealer Name: [Joe Dealer]
- Programmer: [Empty text box]
- System Number: [Empty text box]
- Program Created: Unknown
- Program Last Modified: Unknown
- Compiler Version: [Empty text box] with an "Auto Fill" button.
- OPS Version: [Empty text box] with an "Auto Fill" button.
- Module Characteristics:
 - Symbol Tree Category: A list with checkboxes for Lighting, Media Resource, Memory, and Miscellaneous.
 - Target Control System Classes: A list with checkboxes for No Selection, SmartTouch, CresnetII, and VTS master/slave.
- Module Help: [Empty text box]
- Buttons: "OK" and "Cancel" at the bottom center.

After you convert each module in a program, you can convert the program as described previously: drag the RACK2 onto the existing control system in *System Views* and click **Yes** to confirm the replacement.

For further information about compile-time errors and detailed explanations about working with modules, refer to the SIMPL Windows online help file.

Programming the LCD Screen

The RACK2 LCD screen is preprogrammed with a certain level of diagnostic, testing, and network device information. Assuming the RACK2 is connected to a PC running SIMPL Windows, an LCD screen programming utility (Front Panel Editor) enables a programmer to program multi-level pages under the PANEL (left-most, function) button on the LCD screen.

Front Panel Editor

The LCD screen on a RACK2 has different pages that are defined by the programmer. Menu function buttons are assigned to different pages or objects. The LCD screen has a 2x40 character display with six-programmable buttons.

In Front Panel Editor, pages are designed and added to the panel. An example of the default page is shown after this paragraph. Each front page is one screen (2x40 characters) and can have as many objects as the physical size of the screen allows (objects can not overlap). The top line of the panel is used for informative object displays, such as headings, indirect text, bar graphs, and time/date displays. The bottom line of the panel is for objects that are accessed by the six menu function buttons below the screen. The buttons only access the page or object whose field is directly over the button. Objects added to the bottom line of the screen can have page jumps or logic programming in SIMPL Windows that cause specific events to occur. These objects are initiated by pressing the function button that is associated with it.

Default Front Panel Page**Creating a Page with Front Panel Editor**

NOTE: The creation of a front panel page is discussed in this section. For more details, consult the SIMPL Windows help file. Search for Front Panel Editor.

Assume that a page, as shown after this paragraph, is required. The concept of such an application is that the user can then choose a given device and then, from a lower-level page, control one or more transport functions of the device.

Example of a Front Panel Page**Adding Top-Level Pages and Objects**

Use SIMPL Windows and access the Front Panel Editor by selecting **Project | Edit Front Panel**. Click on the **Add** button and enter a new name for the new page. For this example, use “Menu1 – Choose Device” as the name.

Double click on the front panel (green screen area) to open the “Edit Panel Object” window. This example requires that headings be added to the page, so choose **Text Object** from the *Object Type* area. In the *Inactive Text* field, enter “Choose device” and click **OK**. The object is displayed on the panel. Click on and drag the object to its desired location on the panel, top row.

Add additional objects (VCR, DVD, CD, Lights, and Volume) to the page by double clicking in the screen area where the object is to appear. Repeat the procedure in the previous paragraph; place objects over the appropriate menu function button.

NOTE: Objects on a screen can be copied and pasted for ease of design (using SIMPL Windows v2.00 or later).

Adding Lower-Level Pages and Objects

Lower-level pages can be added for each of the objects on the bottom row of the page just created. For the purpose of this example, one lower-level page is added for the *VCR* object. Simply click on the **Add** button and enter a new name for the new page. For this example, use “Menu2 – VCR Control” as the name.

Return to the “Menu1 – Choose Device” and double click on the *VCR* object. The “Edit Panel Object” window appears. From the *Page Jump* field, select “Menu2 – VCR Control”, as shown after this paragraph, and click **OK**. Select the *Simulate* check box to make the Front Panel Editor simulate an actual RACK2 front panel. Click on the *VCR* function button to enable the simulated page jump. The screen clears, because “Menu2 – VCR Control” has been named, but no objects have been added yet.

Selecting a Page Jump from the "Edit Panel Object" Window

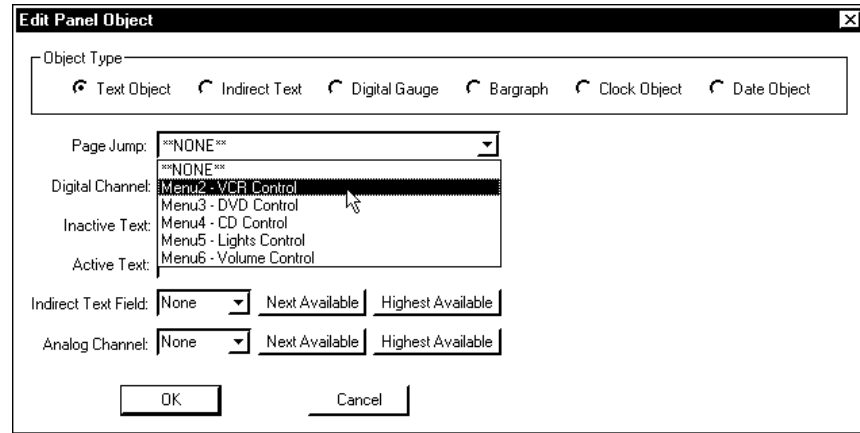

An example VCR Control page, as shown after this paragraph, has a text object that appears as a header on the top row of the screen and objects that are control functions assigned to each function button. Objects in the bottom row are shown in the inactive state (none of the buttons are being pressed).

Example VCR Control Page



Use the “Edit Panel Object” window to add objects to this page. Double click on the first object (**play**). From the *Digital Channel* field in the “Edit Panel Object” window, scroll down to or enter “1”. In the *Active Text* field, enter “PLAY” as the button’s active text. Therefore, when the menu function button associated with digital channel 1 (the VCR button) is pressed, the active text is displayed as a visual cue that the button is pressed. Repeat the procedure for each of the other menu function buttons in the “Menu2 – VCR Control” page, except choose a unique *Digital Channel* and assign the proper control function for each button.

NOTE: Digital channels are also referred to as “join numbers”. Join numbers are numeric identifiers assigned to an object or button. It is necessary to identify objects so the input/output signals of the SIMPL program can be named and routed properly. Digital channels for an object on a page are assigned from the *Digital Channel* field on the "Edit Panel Object" window.

NOTE: Pages on the Front Panel Editor can be assigned a join number to facilitate controlled page jumps. Use the “Front Panel Editor” window, as shown after this

note, to assign the join number. In the *Page Channel* area of this window, a specific number can be assigned or with the appropriate button assign the next or highest available.

Asserting the digital signal for a particular page join number (fb*** on the SIMPL Window symbol) results in a jump to that page. When the system is on a page with a join number, the digital signal corresponding to that join number is asserted for as long as the system is on that page (press *** on the SIMPL Windows symbol).

In this note, *** is used to denote a wildcard.

"Front Panel Editor" Window

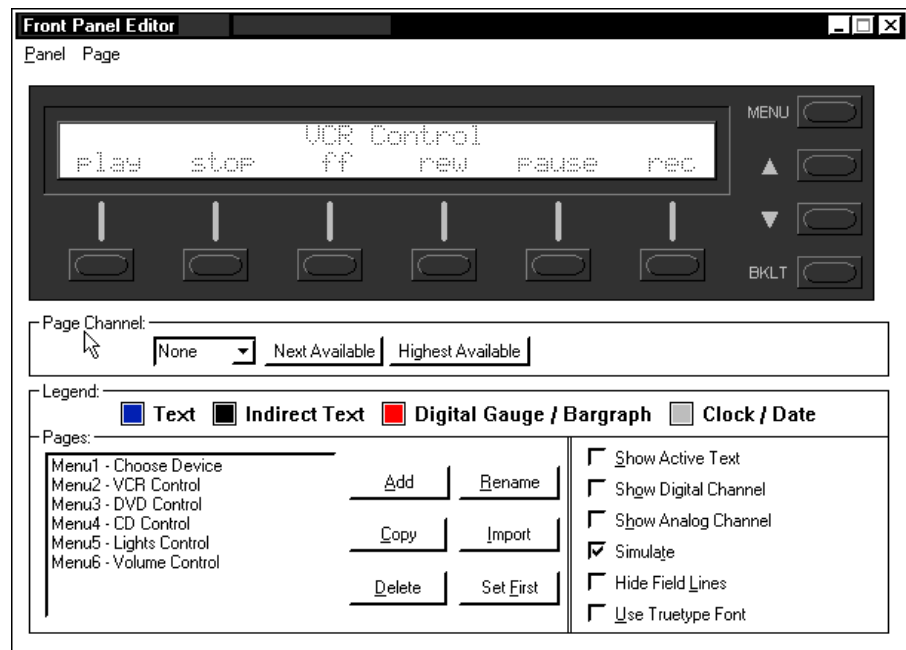

Front Panel Symbol

A powerful tool to assist programmers in naming and routing signals for the LCD screen is the **Synchronize Signals** command. While the panel appears on the PC screen, select **Panel | Synchronize Signal Names** to automatically name all the input and output signals for the front panel in the SIMPL Windows program. To confirm the assignment and display the signal names, double click on *Slot-19: C2I-RACK2-LCDPANEL RACK2 Front Panel*, which is available from the Central Control Modules folder in the *Program View* of the SIMPL Windows Program Manager. The symbol appears in *Detail View*, as shown after this paragraph.

Front Panel Symbol Displayed in SIMPL Windows' Detail View of Programming Manager

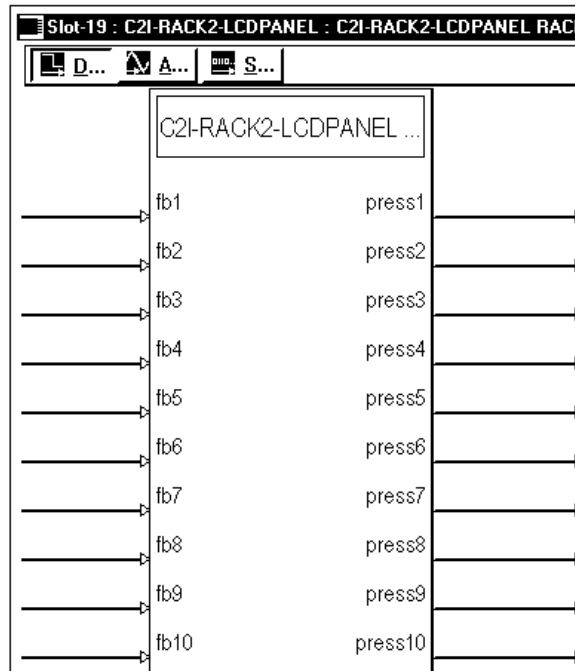

Object Types

The sample discussed in the previous sections utilizes only one of the object types available from the “Edit Panel Object” window, shown below. These object types are not new to Crestron programmers; the same types are available in VT Pro-e.

Object Type Area in the “Edit Panel Object” Window



Problem Solving

Problems may occur with the RACK2 itself or there may be serial communication difficulties with other devices connected to the control system. The next two sections address possible problem solving tools or procedures for each.

Possible Problems with the Control System

Troubleshooting the Control System

The following table provides corrective action for possible trouble situations. If further assistance is required, please contact a Crestron customer service representative.

RACK2 System Troubleshooting

TROUBLE	POSSIBLE CAUSE(S)	CORRECTIVE ACTION
Unexpected response from control system.	Network devices are not communicating to the control system.	From the Viewport, poll the network (F4) to verify communication. Verify adequate Cresnet power. Verify no shorts in wiring. Verify that no two Net Devices have the same Net ID.
PWR LED does not illuminate.	Control system is not receiving power.	If power is supplied through Cresnet cabling, ensure that the cable is securely plugged into the NET connector. Verify adequate Cresnet power. Verify no shorts in wiring. Verify that no two Net Devices have the same Net ID.
ERR LED illuminates.	Hardware or software failure, hardware incompatibility with software definitions, or programming error.	Verify that the hardware configuration matches software configuration. Poll the network (F4) from the Viewport; check error log for SIMPL, SIMPL+ program reload errors. Verify adequate Cresnet power. Verify no shorts in wiring. Verify that no two Net Devices have the same Net ID.
Compilation Error RLCMCVT166 & RLCMCVT177	Poor analog versus serial signal definition in the SIMPL Windows program.	Confirm properly defined signal definition in the program. Verify adequate Cresnet power. Verify no shorts in wiring. Verify that no two Net Devices have the same Net ID.
System locks up.	Various.	Press front panel SW-R and HW-R buttons at the same time to bypass program and communicate directly with processor (refer to "Troubleshooting Communications" on page 23). Verify adequate Cresnet power. Verify no shorts in wiring. Verify that no two Net Devices have the same Net ID.

RACK2 System Troubleshooting (continued)

TROUBLE	POSSIBLE CAUSE(S)	CORRECTIVE ACTION
System does not function.	Incorrect power supply.	Use a Crestron power supply.
A/V system device does not respond. (Depends on which cards are installed)	IRP2 or serial port not placed properly.	Verify placement of IRP2 (Hold phosphor card under IRP2 while pressing button) and tighten serial cables.
	Used wrong IR/Serial port.	Verify that proper IR or serial port is defined.
	Serial cable miswired.	Verify that serial cable is wired correctly for RS-232.

Troubleshooting Non-Functioning Units

Perform the following procedures to correct system lock-up problems that are not resolved via the procedures in “Troubleshooting Communications” on page 23.

1. Connect a DB9 straight-through RS232 cable between the RACK2 and a PC. Refer to “Establishing Communication with the RACK2” on page 21 for more information.
2. Open Viewport and select **Setup | Communication Settings** to open the “Port Settings” window.
3. In the window, select **RS-232** (Connection Type), **57600** (Baud Rate), **N** (Parity), **8** (Data Bits) and **1** (Stop Bits) and click **OK**.
4. Power down the RACK2.
5. While powering up the RACK2, press and hold **ALT** and **K** on the keyboard until the following text (or similar) appears in Viewport:

```
System Monitor [v1.001 (0001)]
12-19-01 16:25:23 32 MB RAM, 4MB FLASH
CS>
```

NOTE: After this, you can increase the baud rate to 115200 (for faster communication) by pressing F8 on the keyboard and then selecting 115200 from the “Set Baud Rate” window.

6. At the Viewport prompt, type **erase** and press Enter. The following text appears in Viewport.

```
CS>erase
->25%->50%->75%->100%
Done
CS>
```
7. Press **ALT** and **O** (not zero) on the keyboard. The “Open” window appears.
8. Find and select the correct firmware file (.CUZ) and click **Open**.
9. Once “Completed Successfully” appears in Viewport, type **quit** at the Viewport prompt and press Enter.

Network Analyzer

To assist with troubleshooting, this unit contains Crestron's patent-pending network analyzer to continuously monitor the integrity of the Cresnet network for wiring faults and marginal system performance or other network errors. For more information on how to use the network analyzer, refer to the SIMPL Windows help file and use the index to search for "Network Analyzer".

Battery Replacement

A Lithium battery is used to power the system clock within the CPU2. Under normal conditions, it will last for approximately 10 years. In the event that the clock fails, only an authorized technician should replace it. Refer to the following caution statement.

CAUTION: Danger of explosion if battery is incorrectly replaced. Replace only with the same or equivalent type recommended by the manufacturer. Dispose of used batteries according to the manufacturer's instructions.

CPU2 and NET2 Replacement

Refer to the latest version of Crestron CPU2 Rack2 Processor Card Installation Guide (Doc. 5961) for CPU2 replacement information.

Refer to the latest version of Crestron NET2 Cresnet Hub Card Installation Guide (Doc. 5960) for NET2 replacement information.

Serial Communication Difficulties with Other Devices Connected to the Control System

Passthrough Mode

Passthrough mode allows data to pass directly from the COMPUTER port to the selected COM port on a Cresnet or Ethernet device (such as ST-COM or CEN-COM), effectively "passing through" the control system. This makes it possible to determine if the communication problem is in the control system or in the device itself. While passthrough mode is running, the program currently in memory is suspended and will not execute. When passthrough mode is exited, the program resumes operation. The TX and RX LEDs for the given port illuminate when in passthrough mode.

Entering passthrough mode for one of the internal COM ports reinitializes it, which clears the data for that port. The COM analyzer also functions while the unit is in passthrough mode.

Passthrough mode is accessed from the Crestron Viewport by selecting **Functions | Enter Passthrough Mode (CNX / 2-Series only)**. The window, shown after this paragraph, is used to select the port configuration for passthrough mode. For more information, refer to the Viewport Help files.

"Passthrough Mode" Window

The screenshot shows a window titled "Passthrough Mode" with a close button (X) in the top right corner. Inside the window, there is a "Setup" section with several dropdown menus:

- Type: Slot
- Slot: 4
- Port: A
- Baud Rate: 9600
- Parity: None
- Data Bits: 8
- Stop Bits: 1
- Protocol: RS-232
- Handshaking: None

Below the setup section, there is a text box with the instruction: "To Exit Passthrough Mode: Select 'Exit Passthrough Mode' from the 'Functions' menu". At the bottom of the window are two buttons: "OK" and "Cancel".

COM Analyzer

NOTE: Only COM-type devices and cards in the SIMPL Windows program that are active (not commented out) are monitored.

Depressing the COM menu function button from the front panel Main Menu (default front panel page) displays a listing of all devices and cards that can be monitored. The listing follows the same order as the system tree in *Configuration Manager*. The top line of the LCD screen provides the COM-type device or card and its port. In the sample shown below, the first active port in the system is the built-in card, port A. The bottom line of the LCD screen provides commands. The user can **SELECT** the COM port shown on the top line or use **NEXT** or **PREV** (appears after scrolling down from the top of the list) to scroll through the entire list of all devices and cards that can be monitored.

Sample of COM-Type Device or Card Listing

NOTE: The **PREV** command only appears after advancing past the first COM-type device or card in the list.

NOTE: The up and down menu selection buttons to the right of the LCD screen may be used in lieu of the **NEXT** and **PREV** menu function buttons.

The data transmitted and received when communicating with another device can be monitored in three formats. Depressing the **SELECT** menu function button displays the Format Type screen, shown after this paragraph. Select the **BIN**, **ASCII**, or **HEX** menu function button to determine the appropriate format.

Select Format Type Screen

Once the **BIN**, **ASCII**, or **HEX** menu function button is selected, the display provides the T/R Screen. The Data Menu in the CNX Series control system contained a **RESET** and **REFRESH** menu function button. A buffer constantly records and recycles the data. The buffer is empty when the COM port is first selected and remains empty until data is transmitted or received.

When the port is active, data information races across the T/R Screen; a sample is shown after this paragraph. The transmission and reception traffic is displayed in alternating sequence to facilitate diagnostics. Depressing any of the six-menu function buttons 'freezes' the data information. The up and down menu selection buttons to the right of the LCD screen may be used to advance or reverse the frozen data. Compare the data to expected manufacturer's protocol for the communicating device.

NOTE: Data in the 'freeze' state is denoted by a lower case letter (f) in front on the T and R in the T/R/Screen.

NOTE: Any of the six-menu function buttons toggles the 'freeze' state.

NOTE: The buffer recycles data even when in the 'freeze' state. When the screen is unfrozen, the display jumps to the end of the buffer.

T/R Screen with Frozen Sample

Further Inquiries

If after reviewing this Operations Guide, you cannot locate specific information or have questions, please take advantage of Crestron's award winning customer service team by calling:

- In the US and Canada, call Crestron's corporate headquarters at 1-888-CRESTRON [1-888-273-7876].
- In Europe, call Crestron International at +32-15-50-99-50.
- In Asia, call Crestron Asia at +852-2341-2016.
- In Latin America, call Crestron Latin America at +5255-5093-2160.
- In Australia and New Zealand, call Crestron Pacific at +613-9480-2999.

Firmware Upgrades

To take advantage of all the RACK2 features, it is important that the unit contains the latest firmware available. Therefore, please check our website (http://www.crestron.com/downloads/software_updates.asp) for the latest version of firmware. Not every product has a firmware upgrade, but as Crestron improves functions, adds new features, and extends the capabilities of our products, firmware upgrades are posted. For questions regarding upgrade procedures, contact Crestron customer service.

Future Updates

As Crestron improves functions, adds new features, and extends the capabilities of the RACK2, additional information may be made available as manual updates. These updates are solely electronic and serve as intermediary supplements prior to the release of a complete technical documentation revision.

Check the Crestron website (www.crestron.com) periodically for manual update availability and its subjective value. Updates are available from the Downloads | Product Manuals section and are identified as an "Addendum" in the Download column.

Software License Agreement

This License Agreement (“Agreement”) is a legal contract between you (either an individual or a single business entity) and Crestron Electronics, Inc. (“Crestron”) for software referenced in this guide, which includes computer software and, as applicable, associated media, printed materials, and “online” or electronic documentation (the “Software”).

BY INSTALLING, COPYING, OR OTHERWISE USING THE SOFTWARE, YOU REPRESENT THAT YOU ARE AN AUTHORIZED DEALER OF CRESTRON PRODUCTS OR A CRESTRON AUTHORIZED INDEPENDENT PROGRAMMER AND YOU AGREE TO BE BOUND BY THE TERMS OF THIS AGREEMENT. IF YOU DO NOT AGREE TO THE TERMS OF THIS AGREEMENT, DO NOT INSTALL OR USE THE SOFTWARE.

IF YOU HAVE PAID A FEE FOR THIS LICENSE AND DO NOT ACCEPT THE TERMS OF THIS AGREEMENT, CRESTRON WILL REFUND THE FEE TO YOU PROVIDED YOU (1) CLICK THE DO NOT ACCEPT BUTTON, (2) DO NOT INSTALL THE SOFTWARE AND (3) RETURN ALL SOFTWARE, MEDIA AND OTHER DOCUMENTATION AND MATERIALS PROVIDED WITH THE SOFTWARE TO CRESTRON AT: CRESTRON ELECTRONICS, INC., 15 VOLVO DRIVE, ROCKLEIGH, NEW JERSEY 07647, WITHIN 30 DAYS OF PAYMENT.

LICENSE TERMS

Crestron hereby grants You and You accept a nonexclusive, nontransferable license to use the Software (a) in machine readable object code together with the related explanatory written materials provided by Crestron (b) on a central processing unit (“CPU”) owned or leased or otherwise controlled exclusively by You, and (c) only as authorized in this Agreement and the related explanatory files and written materials provided by Crestron.

If this software requires payment for a license, you may make one backup copy of the Software, provided Your backup copy is not installed or used on any CPU. You may not transfer the rights of this Agreement to a backup copy unless the installed copy of the Software is destroyed or otherwise inoperable and You transfer all rights in the Software.

You may not transfer the license granted pursuant to this Agreement or assign this Agreement without the express written consent of Crestron.

If this software requires payment for a license, the total number of CPU’s on which all versions of the Software are installed may not exceed one per license fee (1) and no concurrent, server or network use of the Software (including any permitted back-up copies) is permitted, including but not limited to using the Software (a) either directly or through commands, data or instructions from or to another computer (b) for local, campus or wide area network, internet or web hosting services; or (c) pursuant to any rental, sharing or “service bureau” arrangement.

The Software is designed as a software development and customization tool. As such Crestron cannot and does not guarantee any results of use of the Software or that the Software will operate error free and You acknowledge that any development that You perform using the Software or Host Application is done entirely at Your own risk.

The Software is licensed and not sold. Crestron retains ownership of the Software and all copies of the Software and reserves all rights not expressly granted in writing.

OTHER LIMITATIONS

You must be an Authorized Dealer of Crestron products or a Crestron Authorized Independent Programmer to install or use the Software. If Your status as a Crestron Authorized Dealer or Crestron Authorized Independent Programmer is terminated, Your license is also terminated.

You may not rent, lease, lend, sublicense, distribute or otherwise transfer or assign any interest in or to the Software.

You may not reverse engineer, decompile, or disassemble the Software.

You agree that the Software will not be shipped, transferred or exported into any country or used in any manner prohibited by the United States Export Administration Act or any other export laws, restrictions or regulations (“Export Laws”). By downloading or installing the Software You (a) are certifying that You are not a national of Cuba, Iran, Iraq, Libya, North Korea, Sudan, or Syria or any country to which the United States embargoes goods (b) are certifying that You are not otherwise prohibited from receiving the Software and (c) You agree to comply with the Export Laws.

If any part of this Agreement is found void and unenforceable, it will not affect the validity of the balance of the Agreement, which shall remain valid and enforceable according to its terms. This Agreement may only be modified by a writing signed by an authorized officer of Crestron. Updates may be licensed to You by Crestron with additional or different terms. This is the entire agreement between Crestron and You relating to the Software and it supersedes any prior representations, discussions, undertakings, communications or advertising relating to the Software. The failure of either party to enforce any right or take any action in the event of a breach hereunder shall constitute a waiver unless expressly acknowledged and set forth in writing by the party alleged to have provided such waiver.

If You are a business or organization, You agree that upon request from Crestron or its authorized agent, You will within thirty (30) days fully document and certify that use of any and all Software at the time of the request is in conformity with Your valid licenses from Crestron or its authorized agent.

Without prejudice to any other rights, Crestron may terminate this Agreement immediately upon notice if you fail to comply with the terms and conditions of this Agreement. In such event, you must destroy all copies of the Software and all of its component parts.

PROPRIETARY RIGHTS

Copyright. All title and copyrights in and to the Software (including, without limitation, any images, photographs, animations, video, audio, music, text, and “applets” incorporated into the Software), the accompanying media and printed materials, and any copies of the Software are owned by Crestron or its suppliers. The Software is protected by copyright laws and international treaty provisions. Therefore, you must treat the Software like any other copyrighted material, subject to the provisions of this Agreement.

Submissions. Should you decide to transmit to Crestron’s website by any means or by any media any materials or other information (including, without limitation, ideas, concepts or techniques for new or improved services and products), whether as information, feedback, data, questions, comments, suggestions or the like, you agree such submissions are unrestricted and shall be deemed non-confidential and you automatically grant Crestron and its assigns a non-exclusive, royalty-free, worldwide, perpetual, irrevocable license, with the right to sublicense, to use, copy, transmit, distribute, create derivative works of, display and perform the same.

Trademarks. CRESTRON and the Swirl Logo are registered trademarks of Crestron Electronics, Inc. You shall not remove or conceal any trademark or proprietary notice of Crestron from the Software including any back-up copy.

GOVERNING LAW

This Agreement shall be governed by the laws of the State of New Jersey, without regard to conflicts of laws principles. Any disputes between the parties to the Agreement shall be brought in the state courts in Bergen County, New Jersey or the federal courts located in the District of New Jersey. The United Nations Convention on Contracts for the International Sale of Goods, shall not apply to this Agreement.

CRESTRON LIMITED WARRANTY

CRESTRON warrants that: (a) the Software will perform substantially in accordance with the published specifications for a period of ninety (90) days from the date of receipt, and (b) that any hardware accompanying the Software will be subject to its own limited warranty as stated in its accompanying written material. Crestron shall, at its option, repair or replace or refund the license fee for any Software found defective by Crestron if notified by you within the warranty period. The foregoing remedy shall be your exclusive remedy for any claim or loss arising from the Software.

CRESTRON shall not be liable to honor warranty terms if the product has been used in any application other than that for which it was intended, or if it as been subjected to misuse, accidental damage, modification, or improper installation procedures. Furthermore, this warranty does not cover any product that has had the serial number or license code altered, defaced, improperly obtained, or removed.

Notwithstanding any agreement to maintain or correct errors or defects Crestron, shall have no obligation to service or correct any error or defect that is not reproducible by Crestron or is deemed in Crestron’s reasonable discretion to have resulted from (1) accident; unusual stress; neglect; misuse; failure of electric power, operation of the Software with other media not meeting or not maintained in accordance with the manufacturer’s specifications; or causes other than ordinary use; (2) improper installation by anyone other than Crestron or its authorized agents of the Software that deviates from any operating procedures established by Crestron in the material and files provided to You by Crestron or its authorized agent; (3) use of the Software on unauthorized hardware; or (4) modification of, alteration of, or additions to the Software undertaken by persons other than Crestron or Crestron’s authorized agents.

ANY LIABILITY OF CRESTRON FOR A DEFECTIVE COPY OF THE SOFTWARE WILL BE LIMITED EXCLUSIVELY TO REPAIR OR REPLACEMENT OF YOUR COPY OF THE SOFTWARE WITH ANOTHER COPY OR REFUND OF THE INITIAL LICENSE FEE CRESTRON RECEIVED FROM YOU FOR THE DEFECTIVE COPY OF THE PRODUCT. THIS WARRANTY SHALL BE THE SOLE AND EXCLUSIVE REMEDY TO YOU. IN NO EVENT SHALL CRESTRON BE LIABLE FOR INCIDENTAL, CONSEQUENTIAL, SPECIAL OR PUNITIVE DAMAGES OF ANY KIND (PROPERTY OR ECONOMIC DAMAGES INCLUSIVE), EVEN IF A CRESTRON REPRESENTATIVE HAS BEEN ADVISED OF THE POSSIBILITY OF SUCH DAMAGES OR OF ANY CLAIM BY ANY THIRD PARTY. CRESTRON MAKES NO WARRANTIES, EXPRESS OR IMPLIED, AS TO TITLE OR INFRINGEMENT OF THIRD-PARTY RIGHTS, MERCHANTABILITY OR FITNESS FOR ANY PARTICULAR PURPOSE, OR ANY OTHER WARRANTIES, NOR AUTHORIZES ANY OTHER PARTY TO OFFER ANY WARRANTIES, INCLUDING WARRANTIES OF MERCHANTABILITY FOR THIS PRODUCT. THIS WARRANTY STATEMENT SUPERSEDES ALL PREVIOUS WARRANTIES.

Return and Warranty Policies

Merchandise Returns / Repair Service

1. No merchandise may be returned for credit, exchange, or service without prior authorization from CRESTRON. To obtain warranty service for CRESTRON products, contact the factory and request an RMA (Return Merchandise Authorization) number. Enclose a note specifying the nature of the problem, name and phone number of contact person, RMA number, and return address.
2. Products may be returned for credit, exchange, or service with a CRESTRON Return Merchandise Authorization (RMA) number. Authorized returns must be shipped freight prepaid to CRESTRON, Cresskill, N.J., or its authorized subsidiaries, with RMA number clearly marked on the outside of all cartons. Shipments arriving freight collect or without an RMA number shall be subject to refusal. CRESTRON reserves the right in its sole and absolute discretion to charge a 15% restocking fee, plus shipping costs, on any products returned with an RMA.
3. Return freight charges following repair of items under warranty shall be paid by CRESTRON, shipping by standard ground carrier. In the event repairs are found to be non-warranty, return freight costs shall be paid by the purchaser.

CRESTRON Limited Warranty

CRESTRON ELECTRONICS, Inc. warrants its products to be free from manufacturing defects in materials and workmanship under normal use for a period of three (3) years from the date of purchase from CRESTRON, with the following exceptions: disk drives and any other moving or rotating mechanical parts, pan/tilt heads and power supplies are covered for a period of one (1) year; touchscreen display and overlay components are covered for 90 days; batteries and incandescent lamps are not covered.

This warranty extends to products purchased directly from CRESTRON or an authorized CRESTRON dealer. Purchasers should inquire of the dealer regarding the nature and extent of the dealer's warranty, if any.

CRESTRON shall not be liable to honor the terms of this warranty if the product has been used in any application other than that for which it was intended, or if it has been subjected to misuse, accidental damage, modification, or improper installation procedures. Furthermore, this warranty does not cover any product that has had the serial number altered, defaced, or removed.

This warranty shall be the sole and exclusive remedy to the original purchaser. In no event shall CRESTRON be liable for incidental or consequential damages of any kind (property or economic damages inclusive) arising from the sale or use of this equipment. CRESTRON is not liable for any claim made by a third party or made by the purchaser for a third party.

CRESTRON shall, at its option, repair or replace any product found defective, without charge for parts or labor. Repaired or replaced equipment and parts supplied under this warranty shall be covered only by the unexpired portion of the warranty.

Except as expressly set forth in this warranty, CRESTRON makes no other warranties, expressed or implied, nor authorizes any other party to offer any warranty, including any implied warranties of merchantability or fitness for a particular purpose. Any implied warranties that may be imposed by law are limited to the terms of this limited warranty. This warranty statement supercedes all previous warranties.

Trademark Information

All brand names, product names, and trademarks are the sole property of their respective owners. Windows is a registered trademark of Microsoft Corporation. Windows95/98/Me/XP and WindowsNT/2000 are trademarks of Microsoft Corporation.



Crestron Electronics, Inc.
15 Volvo Drive Rockleigh, NJ 07647
Tel: 888.CRESTRON
Fax: 201.767.7576
www.crestron.com

Operations Guide – DOC. 5958
06.03

Specifications subject to
change without notice.