



IEI Technology Corp.



MODEL:

EP-308A/EP-308AS

**Mini POS PC with 1.6GHz Intel® Atom CPU,
VGA Output, Gigabit Ethernet, USB, RS-232, RS-232/422/485,
RoHS Compliant, IP 64 Front Panel**

User Manual

Rev. 1.15 – 18 November, 2010



Revision

Date	Version	Changes
18 November, 2010	1.14	Added paper jam troubleshooting (Section 2.8.1)
1 October, 2010	1.14	Added EP-308AS specifications
3 September, 2009	1.13	Added more details on installing the paper roll
14 July, 2009	1.12	Added screen resolution warning the front matter
24 June, 2009	1.11	Minor edits
23 June, 2009	1.10	Screen brightness changed from 300 nits to 250 nits Power adapter changed from 120 W to 70 W Hardware and firmware upgrades
27 April, 2009	1.00	Initial release

Copyright

COPYRIGHT NOTICE

The information in this document is subject to change without prior notice in order to improve reliability, design and function and does not represent a commitment on the part of the manufacturer.

In no event will the manufacturer be liable for direct, indirect, special, incidental, or consequential damages arising out of the use or inability to use the product or documentation, even if advised of the possibility of such damages.

This document contains proprietary information protected by copyright. All rights are reserved. No part of this manual may be reproduced by any mechanical, electronic, or other means in any form without prior written permission of the manufacturer.

TRADEMARKS

All registered trademarks and product names mentioned herein are used for identification purposes only and may be trademarks and/or registered trademarks of their respective owners.

Table of Contents

1 INTRODUCTION.....	1
1.1 OVERVIEW.....	2
1.2 FEATURES.....	2
1.3 FRONT PANEL.....	3
1.4 CONNECTORS.....	3
1.5 TECHNICAL SPECIFICATIONS.....	4
1.6 DIMENSIONS.....	6
2 INSTALLATION.....	7
2.1 UNPACK THE PANEL PC.....	8
2.2 PACKING LIST.....	9
2.3 DRIVE INSTALLATION.....	10
2.3.1 <i>Hard Drive Installation.....</i>	<i>10</i>
2.3.2 <i>CompactFlash® Installation.....</i>	<i>11</i>
2.4 MOUNTING THE SYSTEM.....	12
2.5 BOTTOM PANEL CONNECTORS.....	12
2.5.1 <i>LAN Connection Cable.....</i>	<i>13</i>
2.5.2 <i>RJ-45 to DB-9 Serial Cable Connection.....</i>	<i>13</i>
2.5.3 <i>USB Device Cable.....</i>	<i>14</i>
2.5.4 <i>VGA Monitor Connection.....</i>	<i>15</i>
2.6 POWER CONNECTION.....	16
2.7 DRIVER INSTALLATION.....	16
2.8 PRINTER PAPER INSTALLATION.....	18
2.8.1 <i>Troubleshooting.....</i>	<i>19</i>
2.9 THERMAL PRINTER SETUP.....	21
2.9.1 <i>EP-308A Thermal Printer Setup.....</i>	<i>21</i>
2.9.1.1 <i>Install the USB to Serial Bridge.....</i>	<i>21</i>
2.9.1.2 <i>Checking Installation.....</i>	<i>23</i>
2.9.1.3 <i>Install the Printer Driver.....</i>	<i>24</i>
2.9.1.4 <i>Setting the Communication Protocol.....</i>	<i>28</i>
2.9.2 <i>EP-308AS Thermal Printer Setup.....</i>	<i>30</i>

EP-308A/EP-308AS POS

2.9.2.1 Install the Printer Driver	30
2.9.2.2 Setting the Communication Protocol	36
3 BIOS SETUP	40
3.1 INTRODUCTION.....	41
3.1.1 Starting Setup.....	41
3.1.2 Using Setup	41
3.1.3 Getting Help.....	42
3.1.4 Unable to Reboot After Configuration Changes.....	42
3.1.5 BIOS Menu Bar.....	42
3.2 MAIN.....	43
3.3 ADVANCED.....	44
3.3.1 CPU Configuration.....	45
3.3.2 IDE Configuration	46
3.3.2.1 IDE Master, IDE Slave	47
3.3.3 Super IO Configuration	52
3.3.4 Hardware Health Configuration.....	54
3.3.5 Power Configuration	57
3.3.5.1 ACPI Settings.....	57
3.3.5.2 APM Configuration.....	58
3.3.6 Remote Access Configuration	60
3.3.7 USB Configuration.....	64
3.3.7.1 USB Mass Storage Device Configuration.....	66
3.4 PCI/PNP.....	67
3.5 BOOT.....	70
3.5.1 Boot Settings Configuration.....	70
3.5.2 Boot Device Priority	73
3.5.3 Hard Disk Drives	74
3.5.4 Removable Drives	74
3.5.5 CD/DVD Drives.....	75
3.6 SECURITY.....	76
3.7 CHIPSET	77
3.7.1 Northbridge Configuration	78
3.7.2 Southbridge Configuration	80
3.8 EXIT.....	81

4 SYSTEM MAINTENANCE	83
4.1 SYSTEM MAINTENANCE INTRODUCTION	84
4.2 MOTHERBOARD REPLACEMENT	84
4.3 COVER REMOVAL	84
4.4 MEMORY MODULE REPLACEMENT	85
4.5 HARD DRIVE AND COMPACTFLASH® REPLACEMENT	86
A SAFETY PRECAUTIONS	87
A.1 SAFETY PRECAUTIONS	88
<i>A.1.1 General Safety Precautions</i>	<i>88</i>
<i>A.1.2 Anti-static Precautions</i>	<i>89</i>
A.2 MAINTENANCE AND CLEANING PRECAUTIONS	89
<i>A.2.1 Maintenance and Cleaning</i>	<i>89</i>
<i>A.2.2 Cleaning Tools</i>	<i>90</i>
B BIOS OPTIONS	91
C TERMINOLOGY	95
D WATCHDOG TIMER	99
E HAZARDOUS MATERIALS DISCLOSURE	102
E.1 HAZARDOUS MATERIALS DISCLOSURE TABLE FOR IPB PRODUCTS CERTIFIED AS ROHS COMPLIANT UNDER 2002/95/EC WITHOUT MERCURY	103

List of Figures

Figure 1-1: EP-308A/EP-308AS.....	2
Figure 1-2: Front Panel	3
Figure 1-3: Connectors	4
Figure 1-4: Dimensions (units in mm)	6
Figure 2-1: Opening The System.....	10
Figure 2-2: Aluminum Back Cover Retention Screws	11
Figure 2-3: CompactFlash® Install.....	11
Figure 2-4: Connectors	12
Figure 2-5: LAN Connection	13
Figure 2-6: Serial Device Connector.....	14
Figure 2-7: USB Device Connection	15
Figure 2-8: VGA Connector	16
Figure 2-9: Available Drivers	17
Figure 2-10: Install Paper Roll	18
Figure 2-11: Center Paper Roll	18
Figure 2-12: U-slot Alignment.....	19
Figure 2-13: Push Down Firmly	19
Figure 2-14: Push the Cover	20
Figure 2-15: Open the Cover	20
Figure 2-16: Push the Paper Cutter into Place	20
Figure 2-17: USB to Serial Driver	21
Figure 2-18: Installation Wizard	22
Figure 2-19: Installation Complete	22
Figure 2-20: USB-Serial Printer Driver	23
Figure 2-21: Printer Installation File	24
Figure 2-22: Printer Driver Installation Wizard	24
Figure 2-23: Select Local Printer.....	25
Figure 2-24: Select Serial Port.....	25
Figure 2-25: Install Printer Software	26
Figure 2-26: Choose Printer Name.....	26

Figure 2-27: Print Test Page	27
Figure 2-28: Printer Installation Complete	27
Figure 2-29: Printer Properties.....	28
Figure 2-30: Configure Printer Port	28
Figure 2-31: Set Communication Options.....	29
Figure 2-32: Printer Installation File	30
Figure 2-33: Printer Driver Installation Wizard	31
Figure 2-34: Select Local Printer.....	31
Figure 2-35: Select Serial Port.....	32
Figure 2-36: Install Printer Software	32
Figure 2-37: Choose Printer Name.....	33
Figure 2-38: Use Existing Driver Page.....	34
Figure 2-39: Print Test Page	35
Figure 2-40: Printer Installation Complete	35
Figure 2-41: Access Printer and Faxes	36
Figure 2-42: Printer Properties.....	37
Figure 2-43: Configure Printer Port	38
Figure 2-44: Set Communication Options.....	39
Figure 4-1: Bottom Cover Retention Screws	85
Figure 4-2: DDR SO-DIMM Module Installation.....	86

List of Tables

Table 1-1: Technical Specifications.....	5
Table 2-1: Packing List.....	10
Table 3-1: BIOS Navigation Keys.....	42

BIOS Menus

BIOS Menu 1: Main	43
BIOS Menu 2: Advanced	44
BIOS Menu 3: CPU Configuration	45
BIOS Menu 4: IDE Configuration	46
BIOS Menu 5: IDE Master and IDE Slave Configuration	47
BIOS Menu 6: Super IO Configuration	52
BIOS Menu 7: Hardware Health Configuration	54
BIOS Menu 8: APM Configuration	57
BIOS Menu 9: ACPI Settings	57
BIOS Menu 10: APM Configuration	58
BIOS Menu 11: Remote Access Configuration	60
BIOS Menu 12: USB Configuration	64
BIOS Menu 13: USB Mass Storage Device Configuration	66
BIOS Menu 14: PCI/PnP Configuration	68
BIOS Menu 15: Boot	70
BIOS Menu 16: Boot Settings Configuration	70
BIOS Menu 17: Boot Device Priority Settings	73
BIOS Menu 18: Hard Disk Drives	74
BIOS Menu 19: Removable Drives	74
BIOS Menu 20: CD/DVD Drives	75
BIOS Menu 21: Security	76
BIOS Menu 22: Chipset	77
BIOS Menu 23: Northbridge Chipset Configuration	78
BIOS Menu 24: Southbridge Chipset Configuration	80
BIOS Menu 25: Exit	81

Chapter

1

Introduction

1.1 Overview



Figure 1-1: EP-308A/EP-308AS

The EP-308A/EP-308AS is a Mini POS with a built-in thermal printer. The EP-308A/EP-308AS has an 8" monitor and a 1.6GHz Intel® Atom processor.

Storage needs are met by installing a SATA hard drive or a CompactFlash® card. CompactFlash® cards with Windows CE 6.0, Windows XPE or Linux are also available.

Wireless networking is enabled through an optional 802.11b/g wireless adapter. With serial ports and USB ports for peripherals and a Gigabit Ethernet slot for networking.

The EP-308A has a 2.0" thermal printer connected to COM port through USB bridge while the 2.0" thermal printer of EP-308AS is connected directly through COM port.

1.2 Features

Some of the standard features of the EP-308A/EP-308AS flat panel PC include:

- Fully self-contained, only power from the external power supply required
- Wireless LAN
- Gigabit Ethernet
- IP 64 compliant front cover
- RoHS compliant

EP-308A/EP-308AS POS

1.3 Front Panel

The front side of the EP-308A/EP-308AS is a flat panel LCD screen surrounded by a frame.

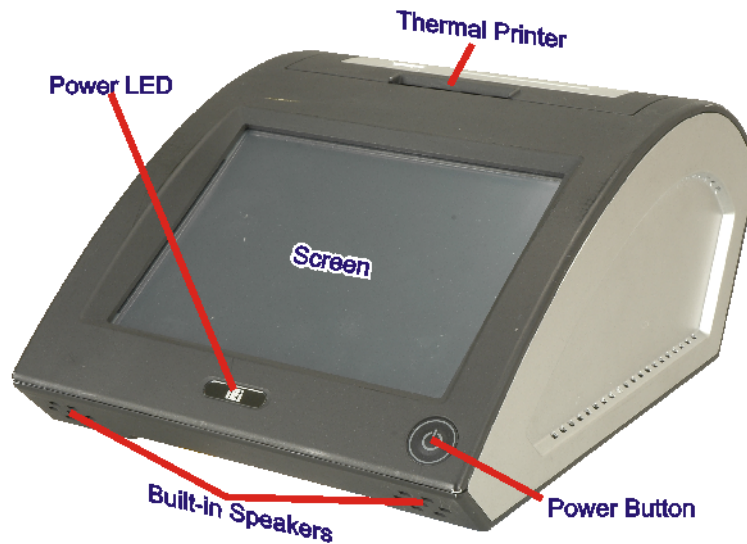

Figure 1-2: Front Panel

1.4 Connectors

The bottom panel has the following slots, buttons and switches (Figure 1-3):

- 1 x Gigabit LAN
- 1 x Power input
- 1 x RJ-12 for cash drawer
- 1 x RS-232
- 1 x RS-232/422/485
- 2 x Dual USB port
- 1 x VGA output
- 1 x AT/ATX switch

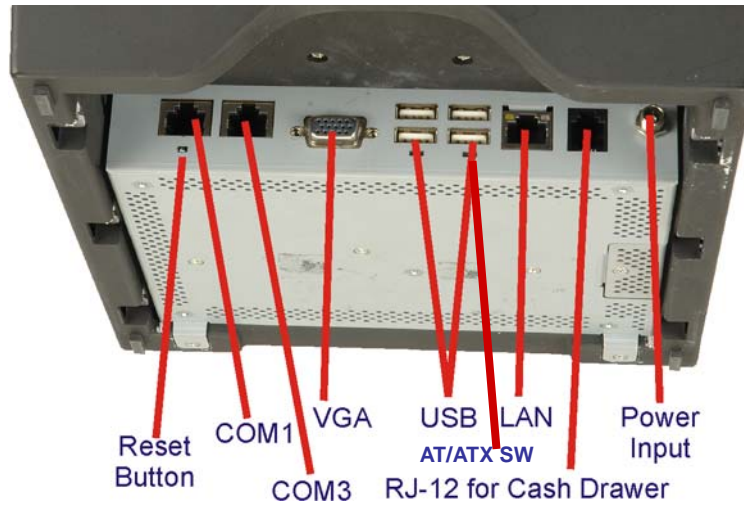

Figure 1-3: Connectors

1.5 Technical Specifications

The technical specifications for the EP-308A/EP-308AS systems are listed in Table 1-1.

SPECIFICATION	EP-308A-N270	EP-308AS-N270
Mainboard	EPMB-945GSE-R10 v1.2	EPMB-945GSE-R10 v1.3
CPU	1.6GHz Intel® Atom	1.6GHz Intel® Atom
LCD Panel	8"	8"
Resolution	800 x 600	800 x 600
Brightness	250 nits	250 nits
Contrast Ratio	500:1	500:1
LCD Colors	262,000	262,000
Pixel Pitch	0.2025 x 0.2025	0.2025 x 0.2025
Viewing Angle (H/V)	130/110	130/110
Backlight MTBF	30000	30000
IP Level	IP 64 front panel	IP 64 front panel

EP-308A/EP-308AS POS

SPECIFICATION	EP-308A-N270	EP-308AS-N270
I/O	1 x Gigabit LAN 1 x Power input (12 V) 1 x RJ-12 for cash drawer 1 x RS-232 1 x RS-232/422/485 4 x USB ports 1 x VGA port	1 x Gigabit LAN 1 x Power input (12 V) 1 x RJ-12 for cash drawer 3 x RS-232 (two internal, one external) 1 x RS-232/422/485 4 x USB ports 1 x VGA port
Printer	2.0" thermal printer with auto-cutting (USB bridge to COM port)	2.0" thermal printer with auto-cutting (COM port)
Power Consumption	43 W (without thermal printer)	43 W (without thermal printer)
Operating Temp.	-10°C ~ 50°C	-10°C ~ 50°C
Dimension (WxHxD)	216.40 mm x 140.45 mm x 301.12 mm	216.40 mm x 140.45 mm x 301.12 mm
Net/Gross Weight	4.2 kg	4.2 kg
EMC and Safety	UL, CE, EMC, FCC, CB, CCC, BSMI	UL, CE, EMC, FCC, CB, CCC, BSMI

Table 1-1: Technical Specifications

1.6 Dimensions

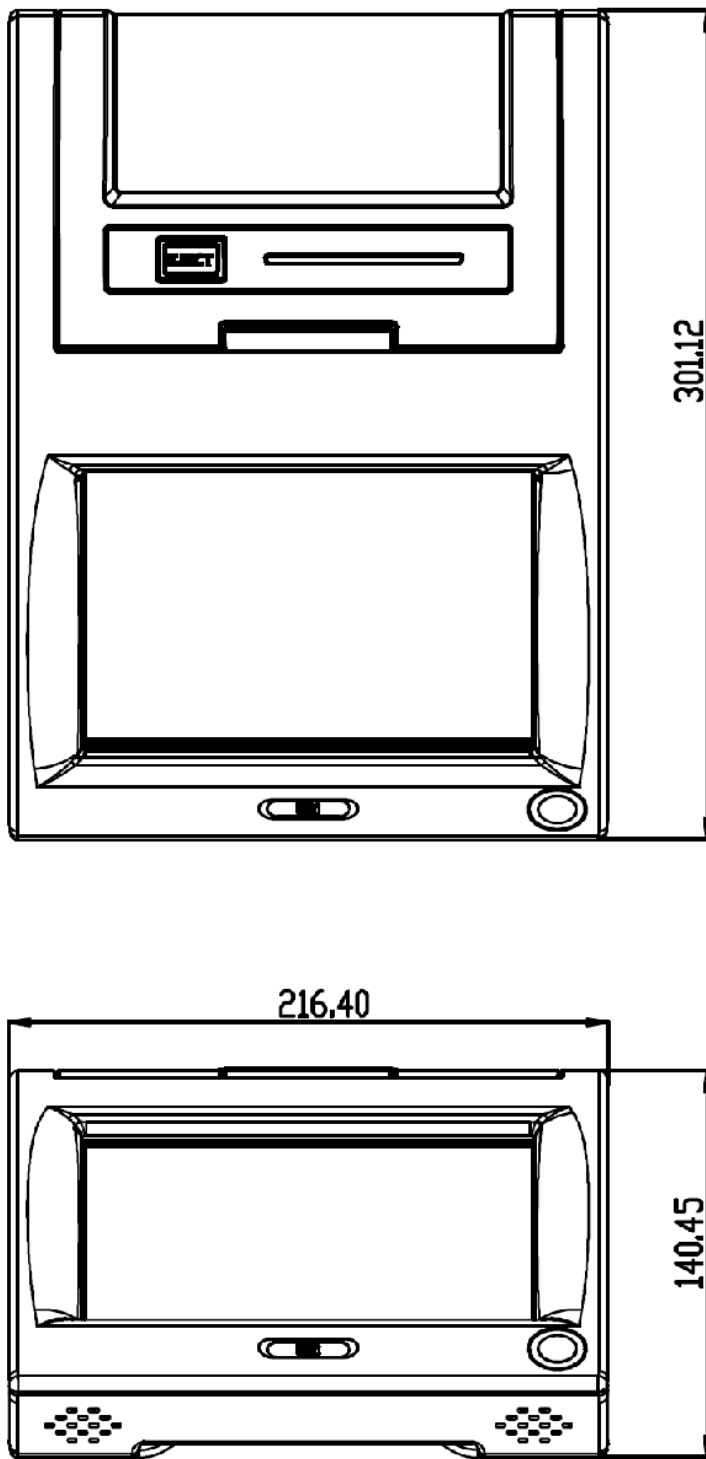

Figure 1-4: Dimensions (units in mm)

Chapter

2

Installation

**WARNING:**

When installing the EP-308A/EP-308AS, make sure to:

- **Set screen resolution to 800 x 600:** To make sure that the touch panel works correctly
- **Turn the power off:** Chance of electrocution. Turn off the monitor and unplug it from the power supply.
- **Only let certified engineers change the hardware settings:** Incorrect settings can cause irreparable damage to the product.
- **Install the monitor with assistance:** The product is very heavy and may be damaged by drops and bumps. Two or more people should install the panel PC.
- **Take anti-static precautions:** Electrostatic discharge can destroy electrical components and injure the user. Users must ground themselves using an anti-static wristband or similar device.

The installation steps below should be followed in order.

Step 1: Unpack the flat panel PC

Step 2: Check all the required parts are included

Step 3: Install the hard drive (optional)

Step 4: Install the CompactFlash® card (if not included)

Step 5: Install the printer paper

Step 6: Connect peripheral devices to the bottom panel of the flat panel PC

Step 7: Connect the power cable

Step 8: Configure the system

2.1 Unpack the Panel PC

To unpack the flat panel PC, follow the steps below:

EP-308A/EP-308AS POS



WARNING!

Only remove the protective plastic cover stuck to the front screen after installation. The plastic layer protects the monitor surface during installation process.

Step 1: Carefully cut the tape sealing the box. Only cut deep enough to break the tape.

Step 2: Open the outside box.

Step 3: Carefully cut the tape sealing the box. Only cut deep enough to break the tape.





Step 4: Open the inside box.

Step 5: Lift the monitor out of the boxes.

Step 6: Remove the peripheral parts box from the main box.

2.2 Packing List

The EP-308A/EP-308AS flat panel PC is shipped with the following components:

Quantity	Item	Image
1	EP-308A/EP-308AS	
1	Power adapter (70 W)	
1	AC power cable	
1	Touch screen pen	



Quantity	Item	Image
2	RJ-45 to DB-9 cable	
1	Utility CD	

Table 2-1: Packing List

2.3 Drive Installation

The EP-308A/EP-308AS supports either a SATA hard drive or a CompactFlash® card. To install the hard drive or CompactFlash® card, first open the bottom as shown below, then refer to the individual installation sections.

Unfasten the screws to remove the bottom section.

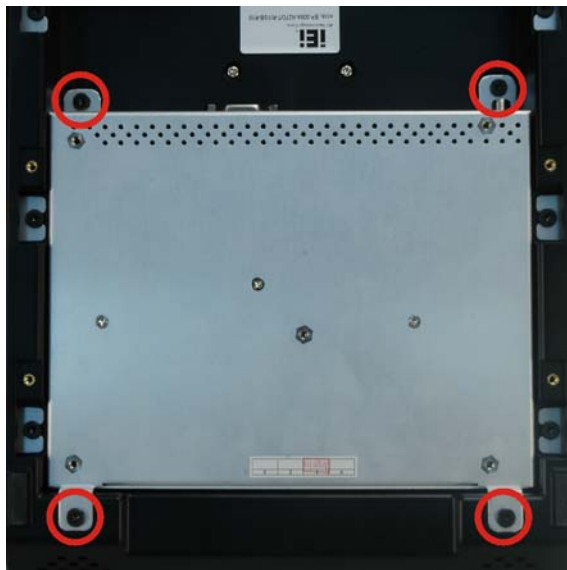
Figure 2-1: Opening The System

2.3.1 Hard Drive Installation

This section outlines the installation of the hard drive in the EP-308A/EP-308AS. To install the hard drive, please follow the steps below:

EP-308A/EP-308AS POS

Step 1: Slice the hard drive on to connect with the SATA connector.

Step 2: Fasten the screws.

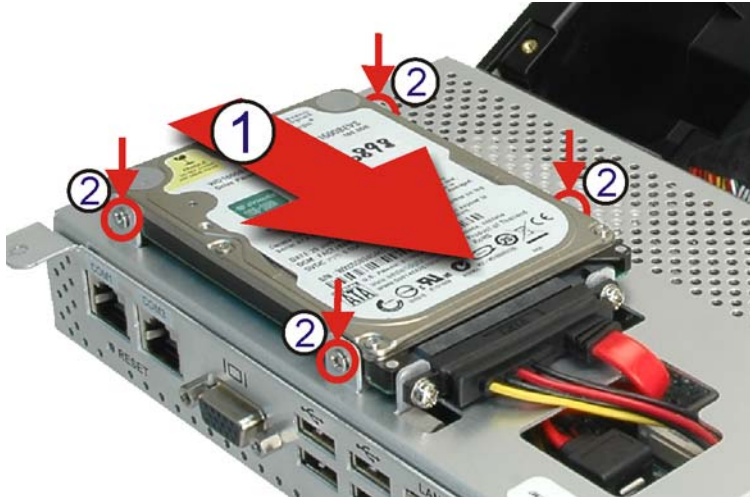

Figure 2-2: Aluminum Back Cover Retention Screws

2.3.2 CompactFlash® Installation

This section covers the installation of the CompactFlash® card.

Step 1: Remove the screw that holds the CompactFlash® card slot cover in place.

Step 2: Install the CompactFlash® card in the slot indicated below.



Figure 2-3: CompactFlash® Install

Step 3: Replace the cover and fasten the screws.

2.4 Mounting the System



WARNING!

Dropping the EP-308A/EP-308AS can cause irreparable damage.
Handle the EP-308A/EP-308AS with care during installation.

The following installation options are available:

- Lift stand
- Wall arm
- Wall mount
- Ceiling mount
- Mobile mount

The installation instructions are included with the stand, arm or mount.

2.5 Bottom Panel Connectors

The bottom panel connectors extend the capabilities of the panel PC but are not essential for operation (except power).

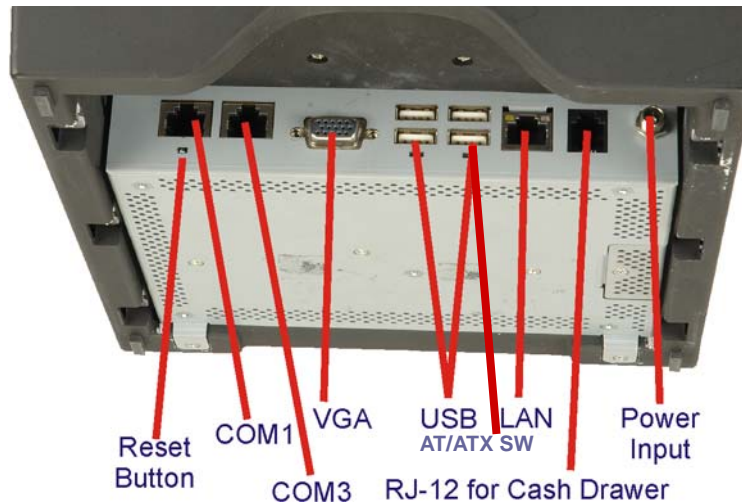

Figure 2-4: Connectors

EP-308A/EP-308AS POS

2.5.1 LAN Connection Cable

The RJ-45 connectors enable connection to an external network. To connect a LAN cable with an RJ-45 connector, please follow the instructions below.

Step 1: Locate the RJ-45 connector on the bottom panel.

Step 2: Align the connectors. Align the RJ-45 connector on the LAN cable with one of the RJ-45 connectors on the bottom panel. See Figure 2-5..

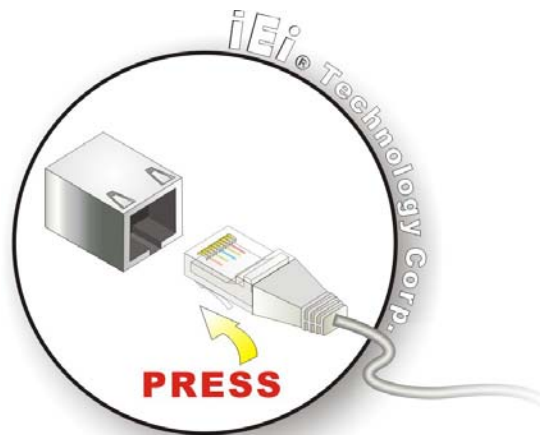

Figure 2-5: LAN Connection

Step 3: Insert the LAN cable RJ-45 connector. Once aligned, gently insert the LAN cable RJ-45 connector into the onboard RJ-45 port.

2.5.2 RJ-45 to DB-9 Serial Cable Connection

The EP-308A/EP-308AS has two serial device connectors on the bottom panel. The two serial device slots (RJ-45) connect to a cable with a standard DB-9 connector at the other end (cables included). Follow the steps below to connect a serial device to the EP-308A/EP-308AS panel PC.

Step 1: Locate the RJ-45 connector. The location of the RJ-45 serial port connector is shown in **Chapter 2**. The RJ-45 connectors for the serial ports can be identified easily as the RJ-45 for the network has two LEDs on the port, while the connectors for the serial cables don't.

Step 2: Insert the RJ-45 to DB-9 cable.

Step 3: Insert the serial connector. Insert the DB-9 connector of a serial device into the DB-9 connector on the cable. See Figure 2-6.

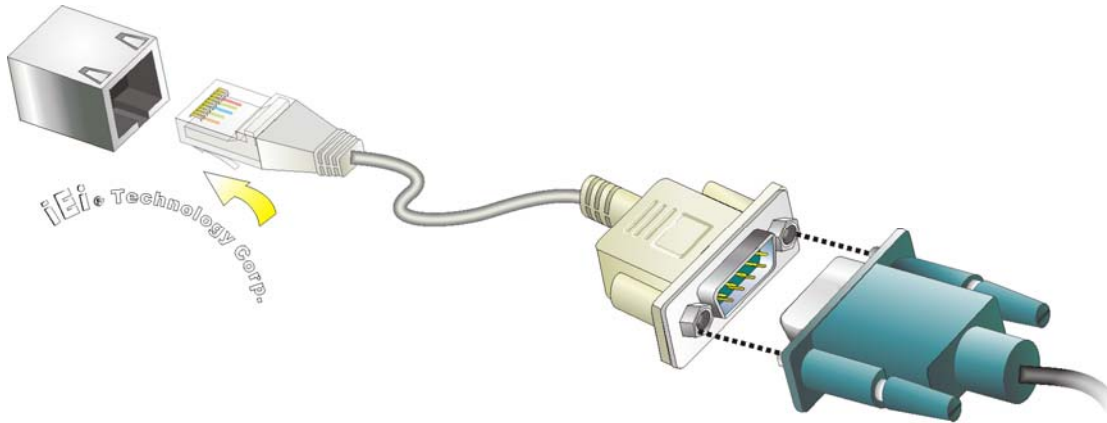

Figure 2-6: Serial Device Connector

Step 4: Secure the connector. Secure the serial device connector to the external interface by tightening the two retention screws on either side of the connector.

2.5.3 USB Device Cable

To connect USB devices, please follow the instructions below.

Step 1: Located the USB connectors. The locations of the USB connectors are shown in **Chapter 2**.

Step 2: Align the connectors. Align the USB device connector with one of the connectors on the bottom panel. See Figure 2-7.

EP-308A/EP-308AS POS

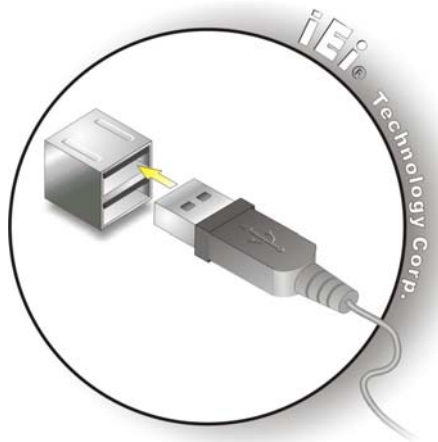

Figure 2-7: USB Device Connection

Step 3: Insert the device connector. Once aligned, gently insert the USB device connector into the onboard connector.

2.5.4 VGA Monitor Connection

The EP-308A/EP-308AS has a single female DB-15 connector on the external peripheral interface panel. The DB-15 connector is connected to a CRT or VGA monitor. To connect a monitor to the EP-308A/EP-308AS, please follow the instructions below.

- Step 1: Locate the female DB-15 connector.** The location of the female DB-15 connector is shown in **Chapter 3**.
- Step 2: Align the VGA connector.** Align the male DB-15 connector on the VGA screen cable with the female DB-15 connector on the external peripheral interface.
- Step 3: Insert the VGA connector** Once the connectors are properly aligned with the insert the male connector from the VGA screen into the female connector on the EP-308A/EP-308AS. See Figure 2-8.

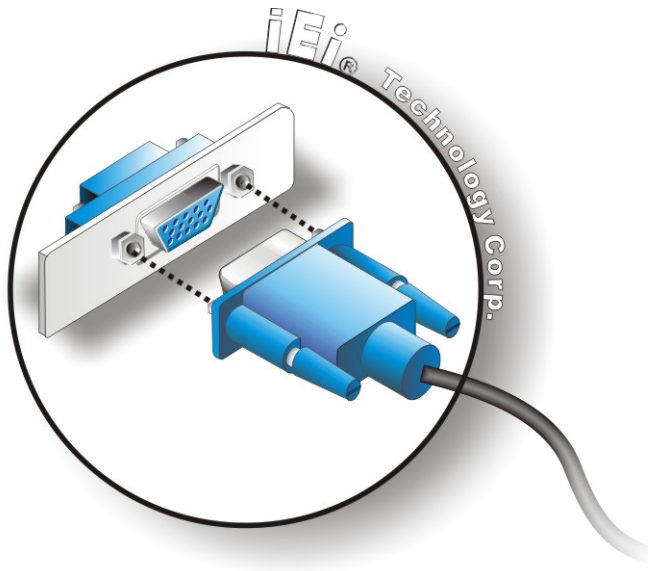

Figure 2-8: VGA Connector

Step 4: **Secure the connector.** Secure the DB-15 VGA connector from the VGA monitor to the external interface by tightening the two retention screws on either side of the connector.

2.6 Power Connection

To connect the power adapter, do the following.

Step 1: Connect the power adapter to the EP-308A/EP-308AS.

Step 2: Connect the power adapter to the mains power.

2.7 Driver Installation



NOTE:

The contents of the CD may vary throughout the life cycle of the product and is subject to change without prior notice. Visit the IEI website or contact technical support for the latest updates.

EP-308A/EP-308AS POS

The following drivers can be installed on the system, each driver is in its own directory on the driver CD. Install the drivers from each other directories shown.

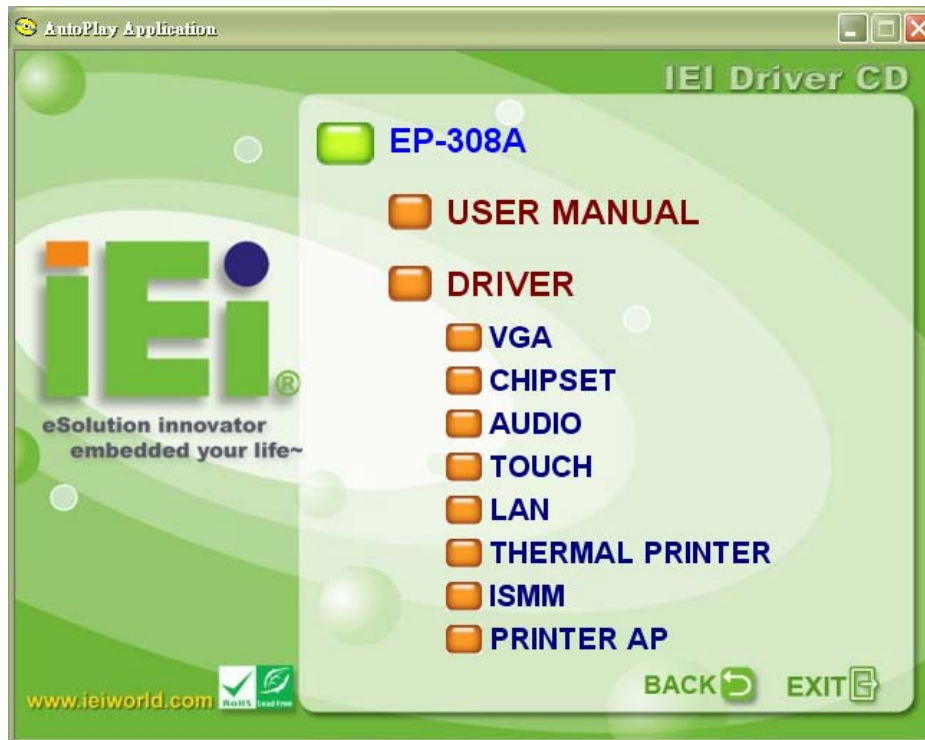

Figure 2-9: Available Drivers

2.8 Printer Paper Installation

To install the roll of paper for the cash register, please follow the steps below.

Step 1: Insert the roll of paper as shown below.



Figure 2-10: Install Paper Roll

Step 2: Make sure the paper is centered.



Figure 2-11: Center Paper Roll

EP-308A/EP-308AS POS

Step 3: The paper should pass through the U-slot as shown below.



Figure 2-12: U-slot Alignment

Step 4: Push the cover down firmly until it clicks into place.



Figure 2-13: Push Down Firmly

2.8.1 Troubleshooting

When paper or cutter jams, do not open the cover with a sharp object. Follow the guide below to troubleshoot:

Step 1: Push the cover down firmly until it clicks into place.



Figure 2-14: Push the Cover

Step 2: Press the EJECT button to open the cover.



Figure 2-15: Open the Cover

Step 3: If the problem remains, shut down the system. Use a small screwdriver to push the paper cutter back into place then redo **Step 1** and **Step 2**.



Figure 2-16: Push the Paper Cutter into Place

EP-308A/EP-308AS POS

2.9 Thermal Printer Setup

The EP-308A has a 2.0" thermal printer connected to COM port through USB bridge while the thermal printer of EP-308AS is connected directly through COM port. The following sections describe the thermal printer setup procedures for the EP-308A and the EP-308AS.

2.9.1 EP-308A Thermal Printer Setup

The internal printer of the EP-308A is connected to the serial port COMx through USB bridge. To setup the EP-308A thermal printer, please follow the steps below.

2.9.1.1 Install the USB to Serial Bridge

Step 1: Run "PL-2303 Driver Installer.exe"

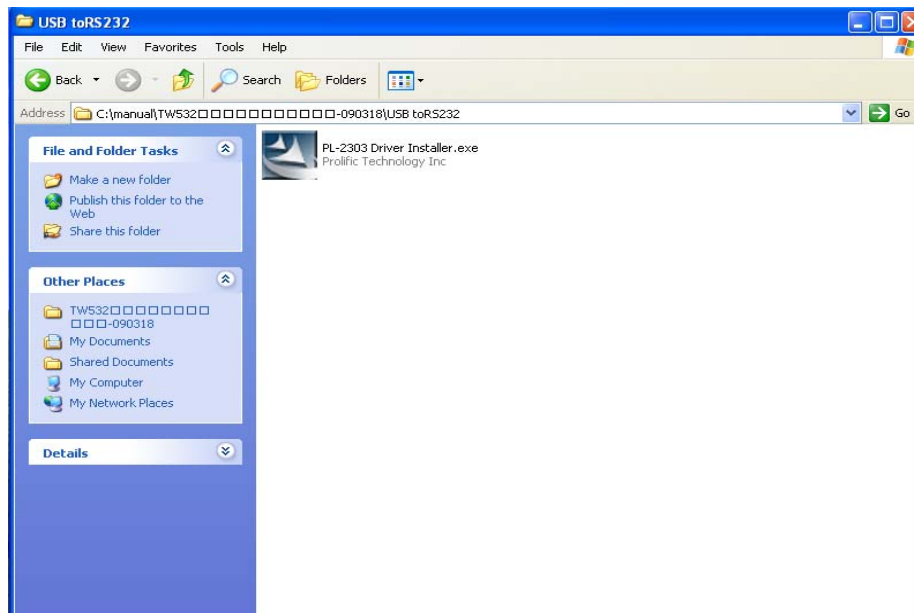

Figure 2-17: USB to Serial Driver

Step 2: Click **NEXT** to start the driver installation.

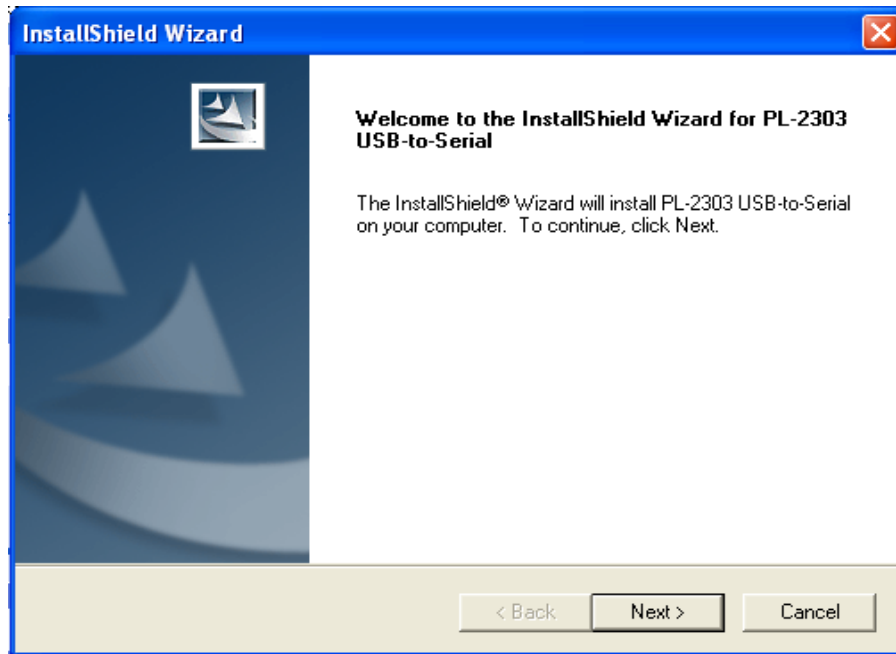

Figure 2-18: Installation Wizard

Step 3: Click **FINISH** to complete the installation and exit the installation wizard.

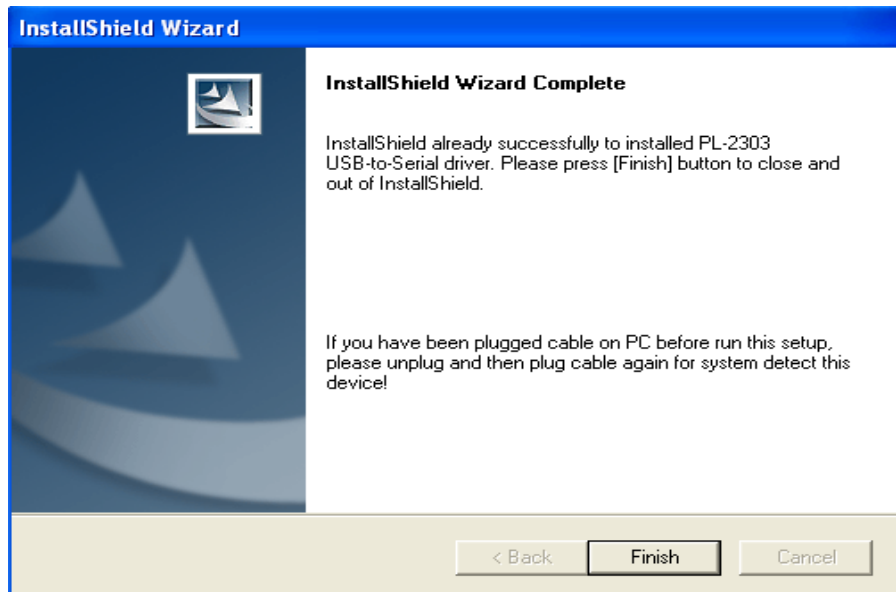

Figure 2-19: Installation Complete

2.9.1.2 Checking Installation

To check the installation, look for the USB device shown in the diagram below.

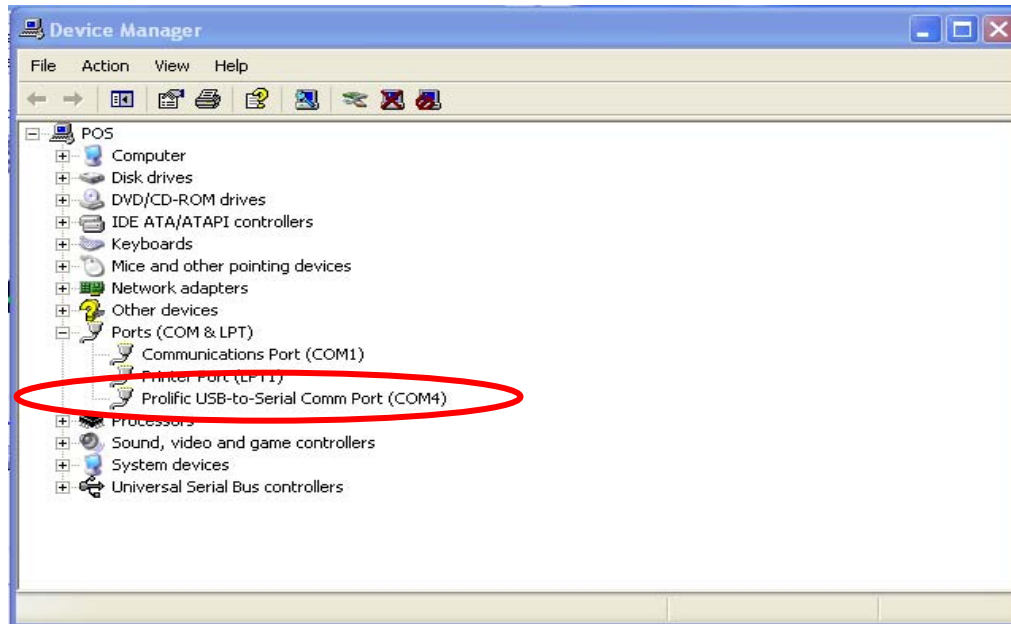

Figure 2–20: USB–Serial Printer Driver

2.9.1.3 Install the Printer Driver

Step 1: Extract the driver from "F732".

Step 2: Run "Install.exe"

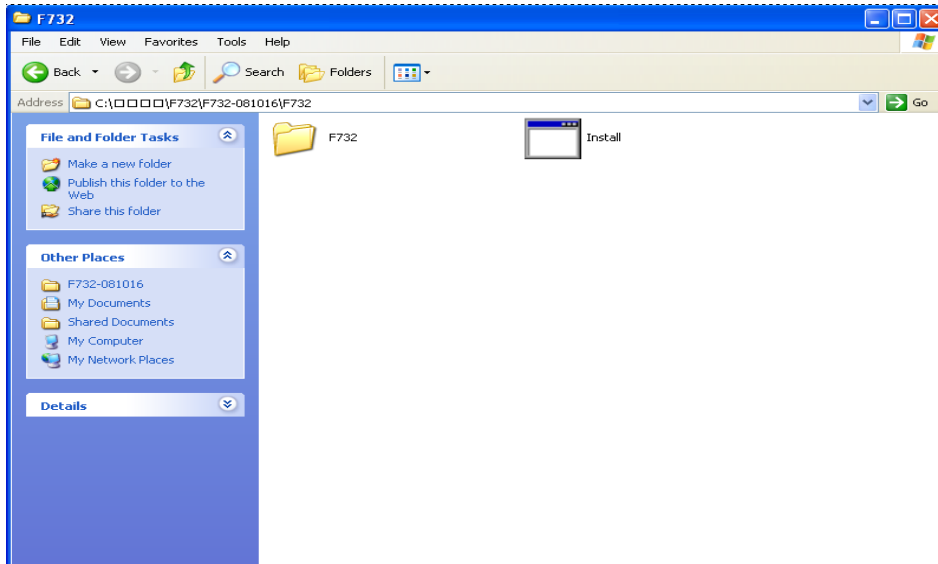

Figure 2-21: Printer Installation File

Step 3: Click NEXT to start the printer driver installation wizard.



Figure 2-22: Printer Driver Installation Wizard

Step 4: Select "Local printer attached to this computer" then click **NEXT**.

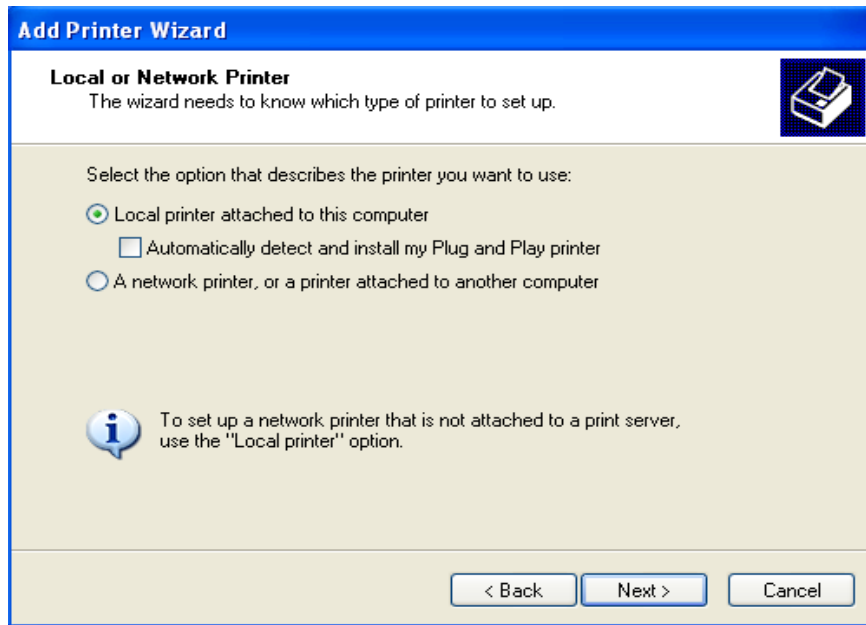

Figure 2-23: Select Local Printer

Step 5: Select "COMx (Serial Port)" then click Next to continue

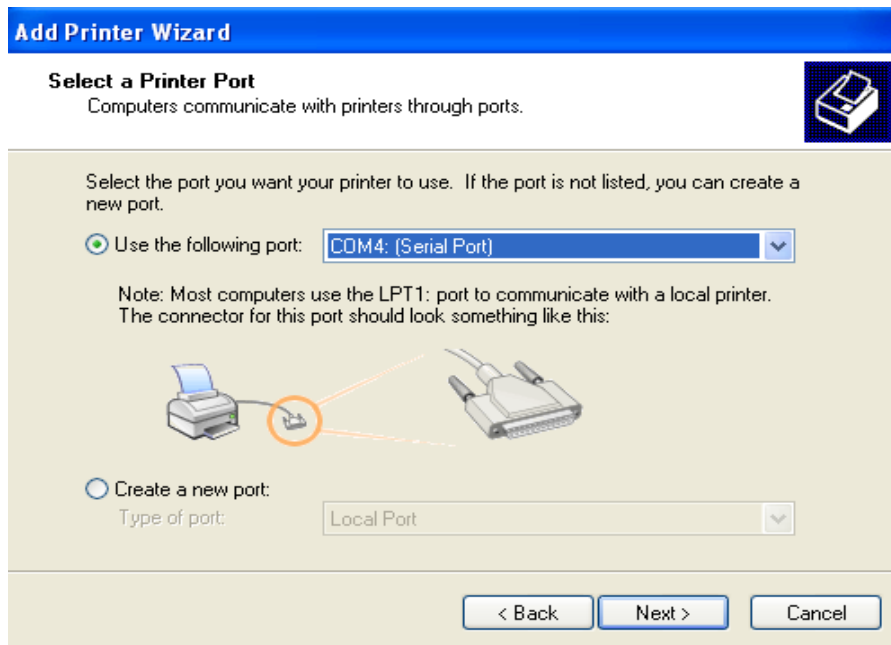

Figure 2-24: Select Serial Port

Step 6: Select "PrnTek-54C" then click **NEXT** to continue.

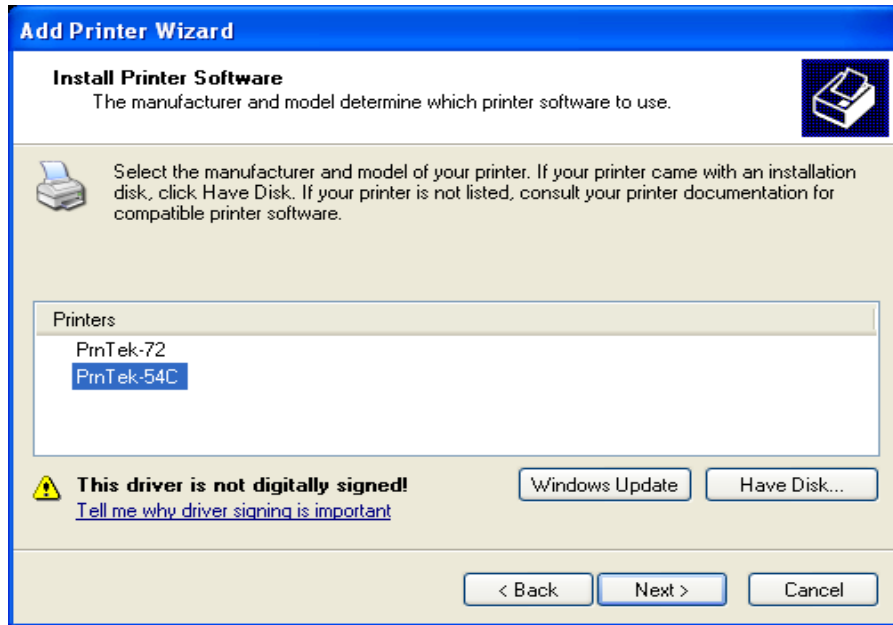

Figure 2-25: Install Printer Software

Step 7: Enter a name for the printer, then click **NEXT** to continue.

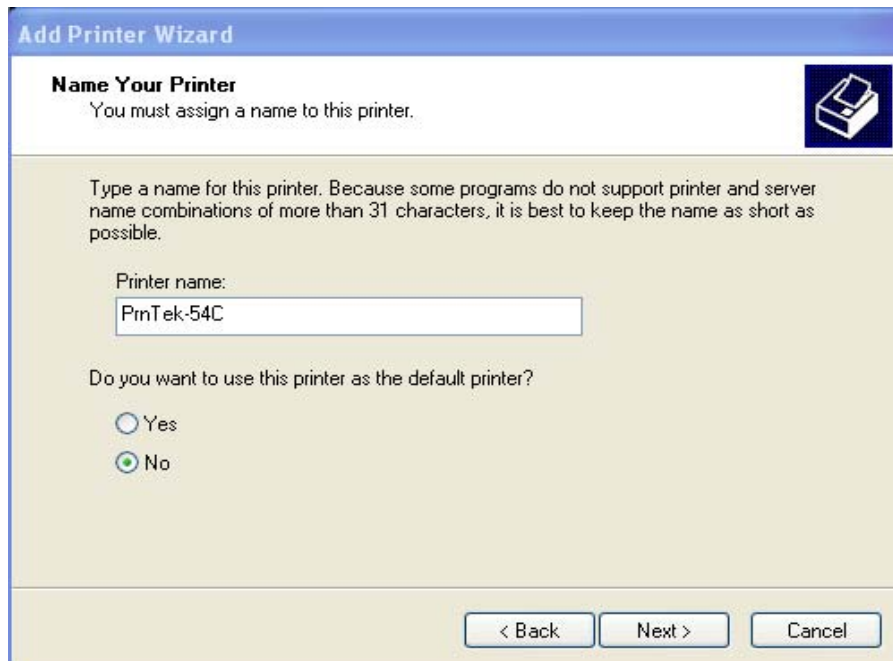

Figure 2-26: Choose Printer Name

Step 8: Choose whether or not to print a test page, then click **NEXT** to continue.

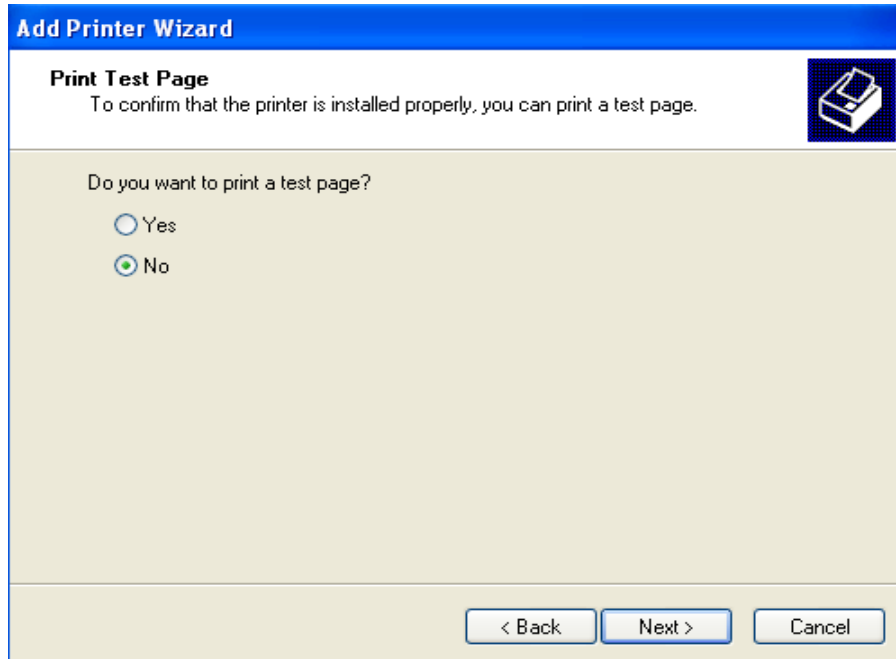

Figure 2-27: Print Test Page

Step 9: Click **FINISH** to complete the driver installation and exit the Installation Wizard.

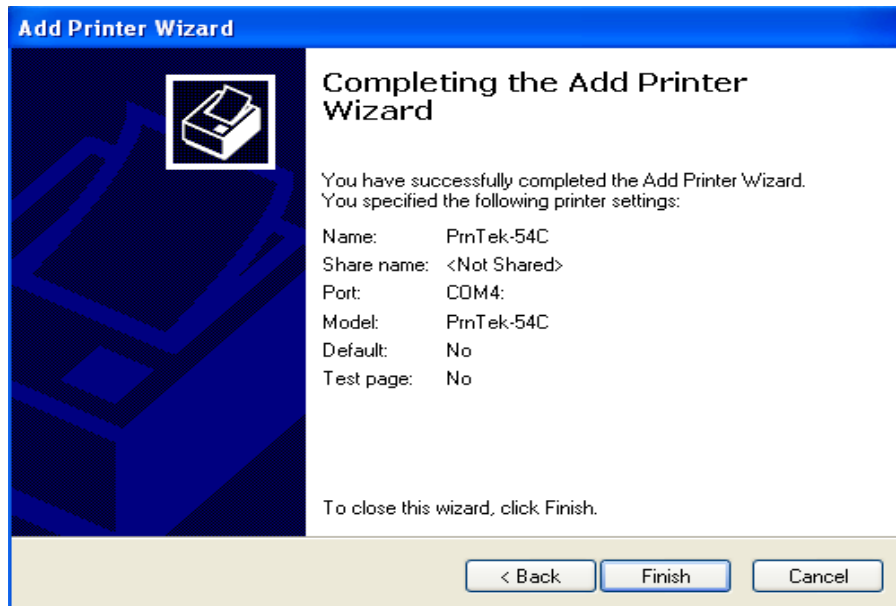

Figure 2-28: Printer Installation Complete

2.9.1.4 Setting the Communication Protocol

Step 1: Right-click the printer icon in "Printers and Faxes", then select "Properties".

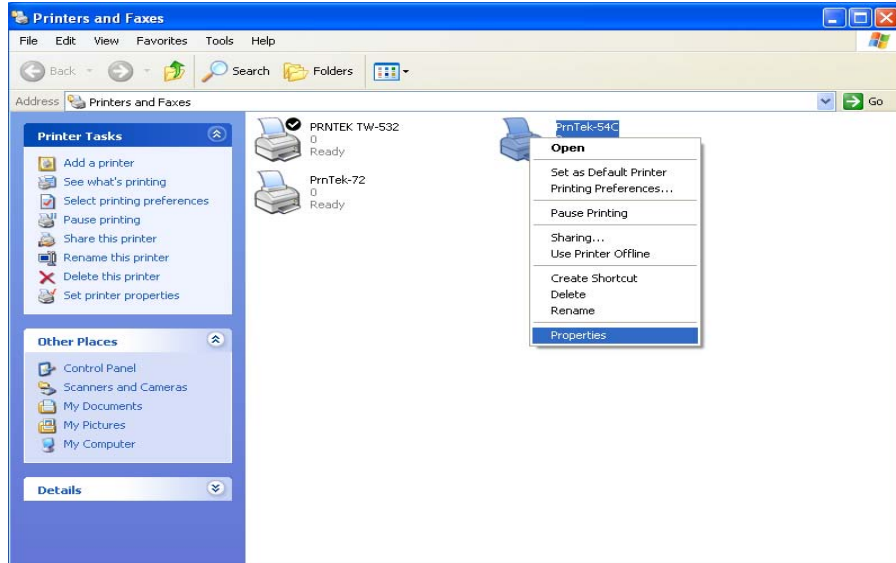

Figure 2-29: Printer Properties

Step 2: Select "COMx: Serial Port", then click "Configure Port..."

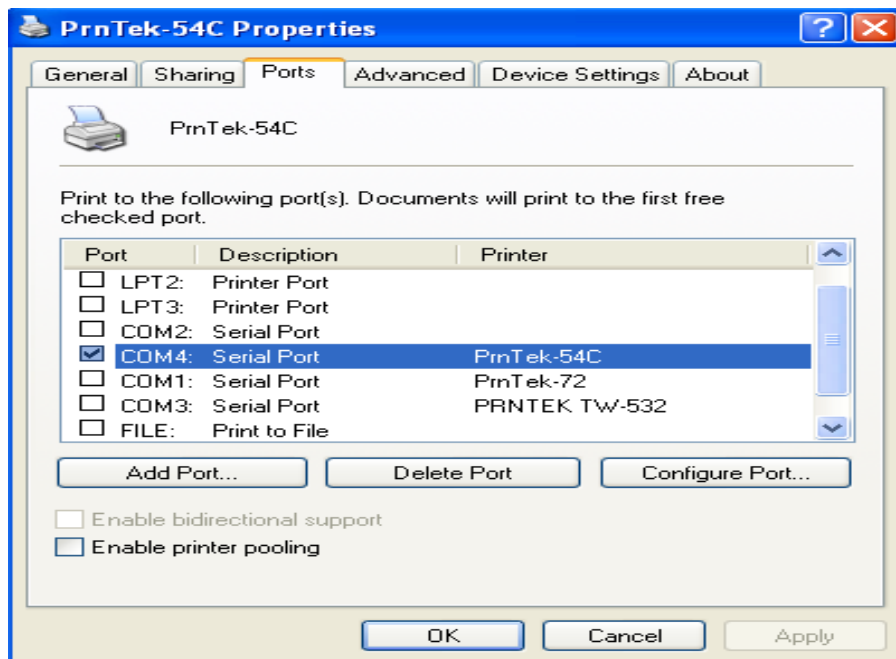

Figure 2-30: Configure Printer Port

EP-308A/EP-308AS POS

Step 3: Set the options in Figure 2-31 as shown below.

- Bits per second: 460800
- Data bits: 8
- Parity: None
- Stop bits: 1
- Flow control: Xon / Xoff

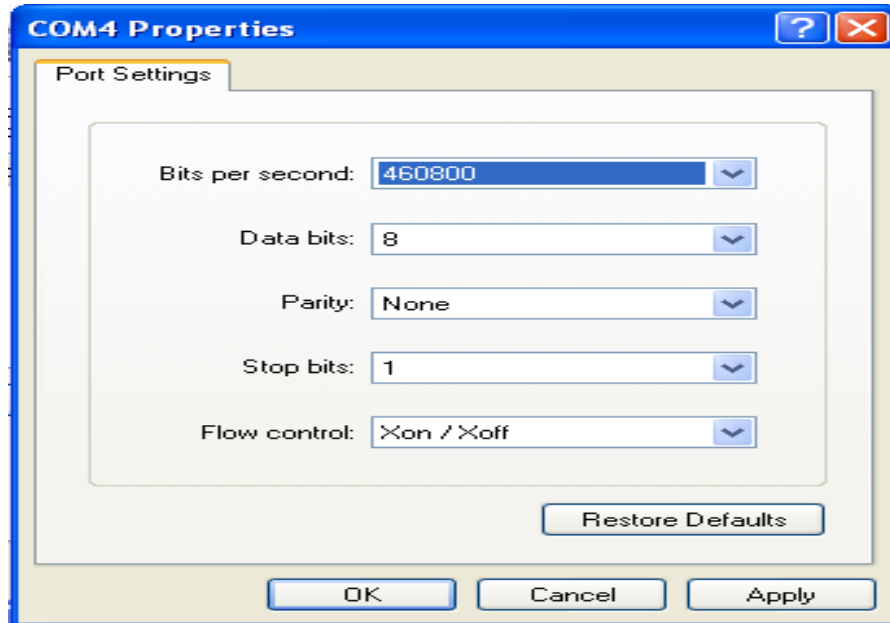

Figure 2-31: Set Communication Options

Step 4: Click OK to apply the changes.



WARNING:

The thermal printer will be destroyed if pulled, dragged or opened while printing.

2.9.2 EP-308AS Thermal Printer Setup

The internal printer of the EP-308AS is connected to the serial port COMx. To setup EP-308AS thermal printer, please follow the steps below.

2.9.2.1 Install the Printer Driver

Step 1: Extract the driver from "F732".

Step 2: Run "Install.exe"

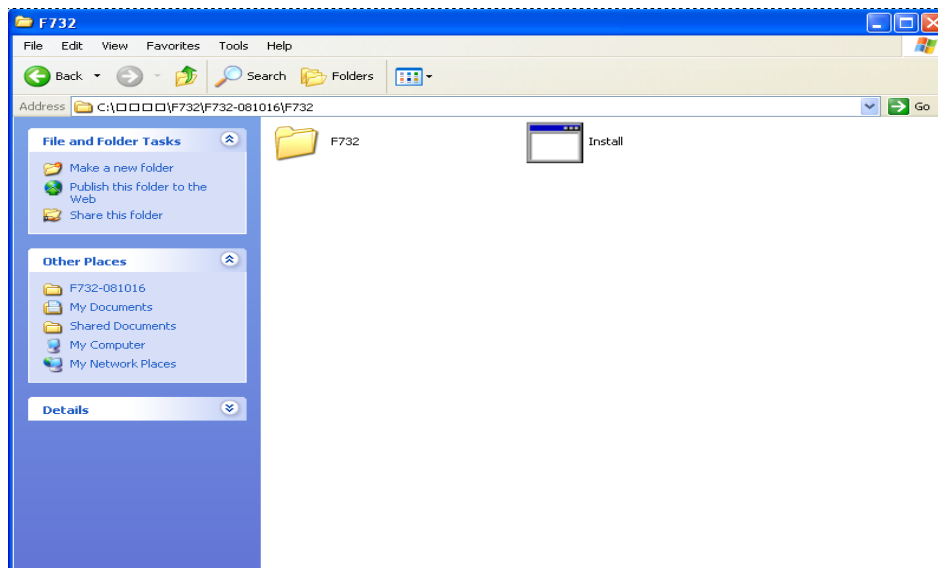

Figure 2-32: Printer Installation File

Step 3: Click **NEXT** to start the printer driver installation wizard.



Figure 2-33: Printer Driver Installation Wizard

Step 4: Select "Local printer attached to this computer" then click **NEXT**.

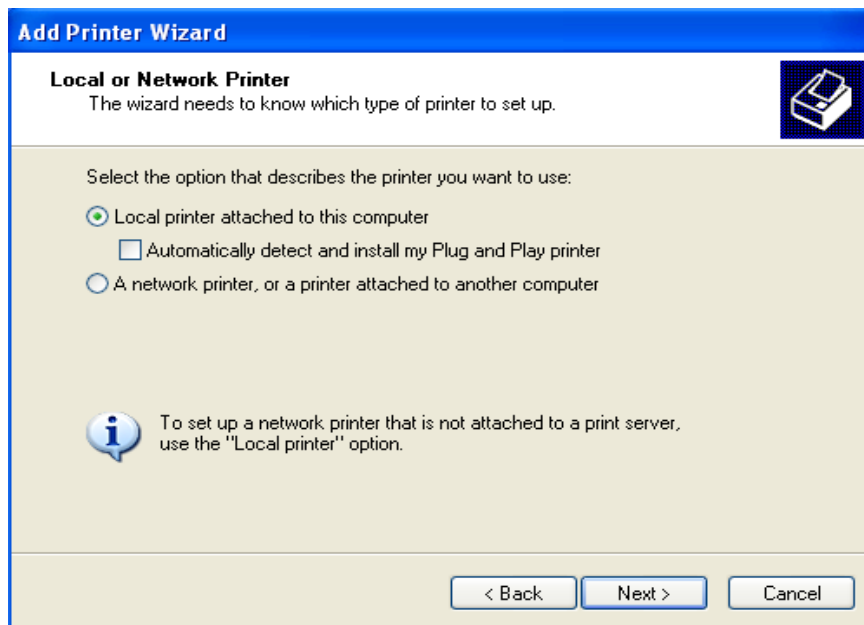

Figure 2-34: Select Local Printer

Step 5: Select "COM5 (Serial Port)", then click **NEXT** to continue

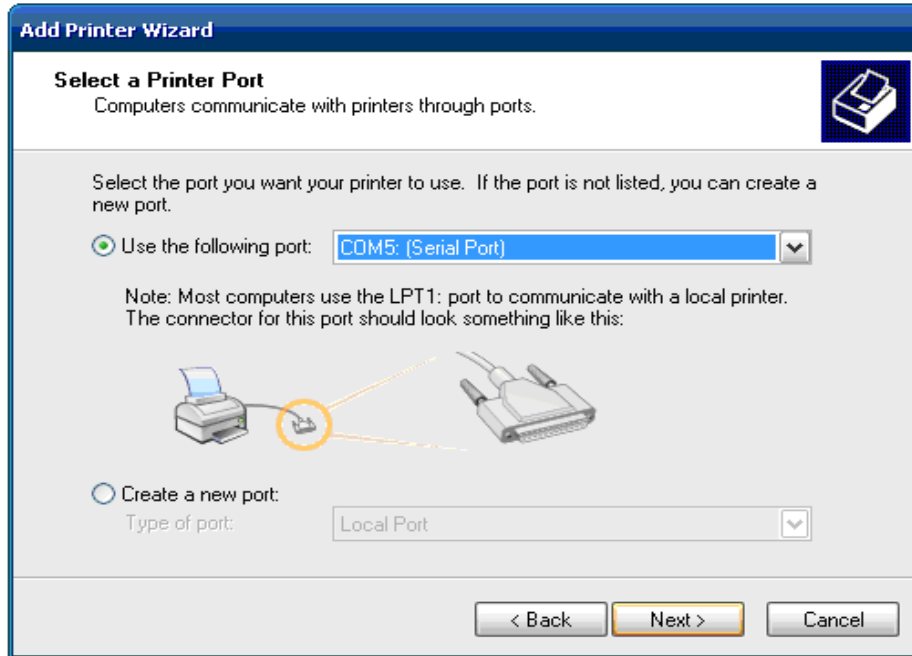

Figure 2-35: Select Serial Port

Step 6: Select "PrnTek-54C" then click **NEXT** to continue.

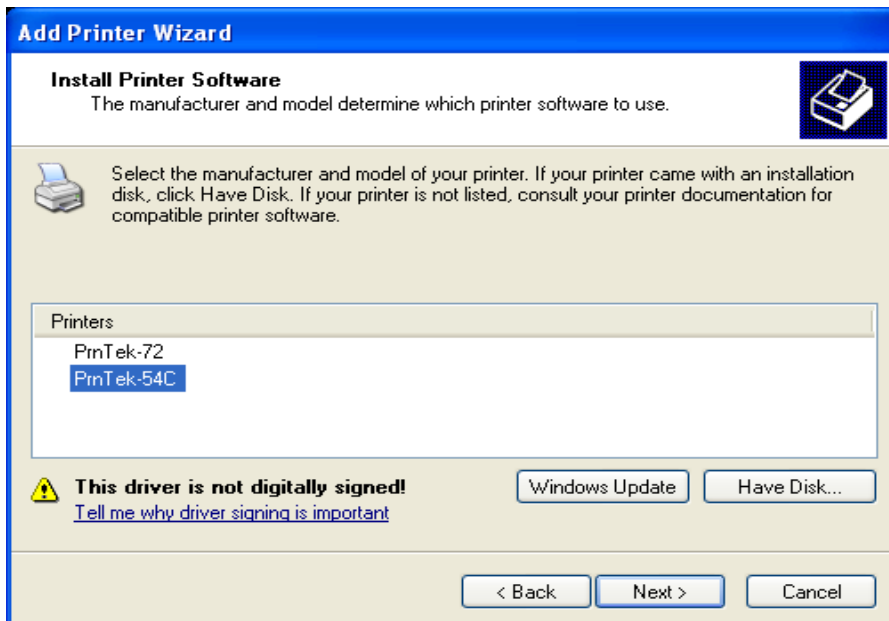
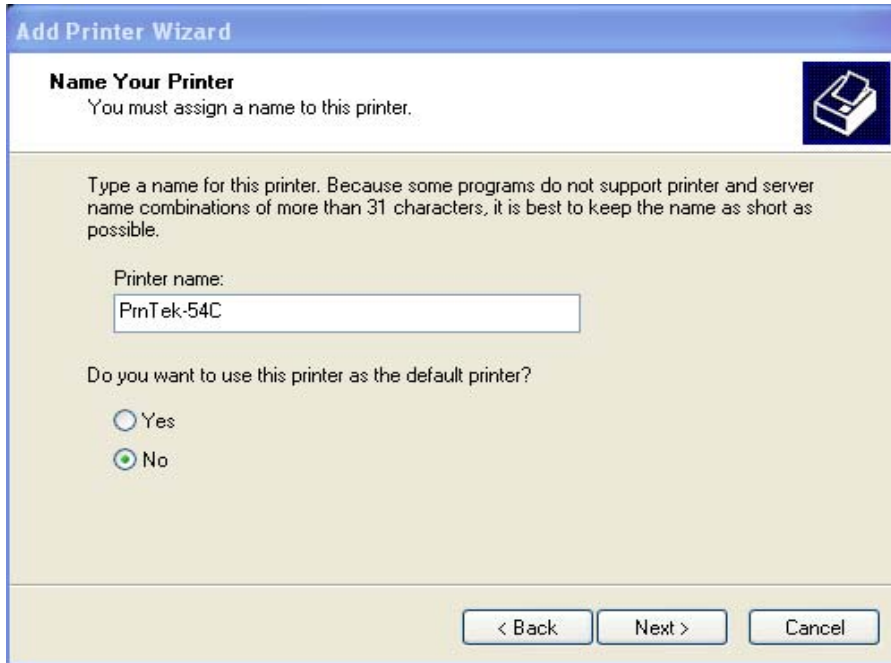

Figure 2-36: Install Printer Software

EP-308A/EP-308AS POS

Step 7: Enter a name for the printer, then click **NEXT** to continue.



The screenshot shows a Windows-style dialog box titled "Add Printer Wizard". The main heading is "Name Your Printer" with a sub-instruction: "You must assign a name to this printer." To the right is a printer icon. Below this, a paragraph explains: "Type a name for this printer. Because some programs do not support printer and server name combinations of more than 31 characters, it is best to keep the name as short as possible." A text input field labeled "Printer name:" contains the text "PrnTek-54C". Below the field, the question "Do you want to use this printer as the default printer?" is followed by two radio buttons: "Yes" (unselected) and "No" (selected). At the bottom right, there are three buttons: "< Back", "Next >", and "Cancel".

Figure 2-37: Choose Printer Name

Step 8: Select “Replace existing driver”, then click **NEXT** to continue.

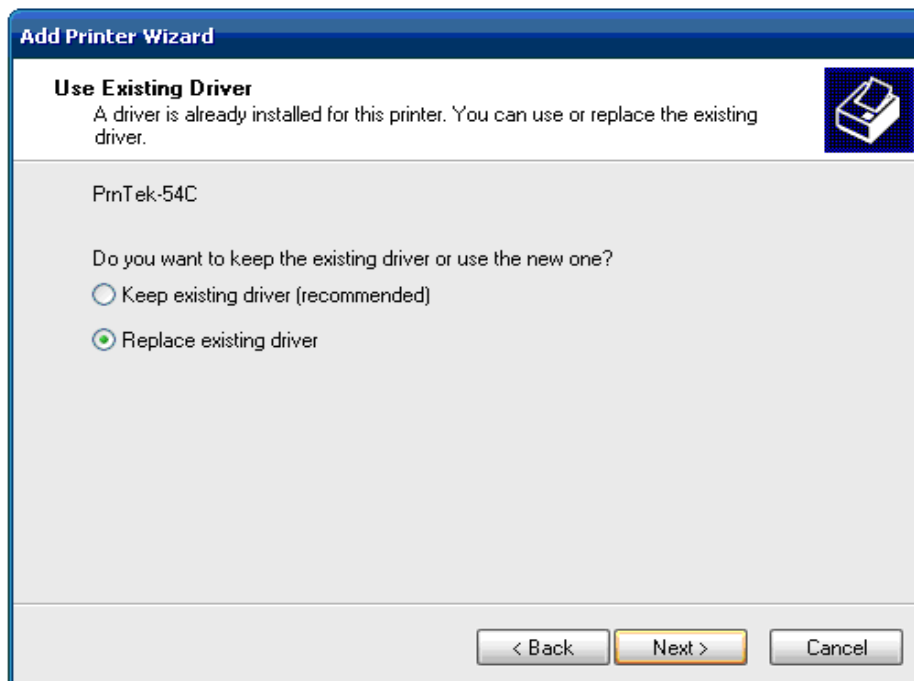

Figure 2-38: Use Existing Driver Page

Step 9: Choose whether or not to print a test page, then click **NEXT** to continue.

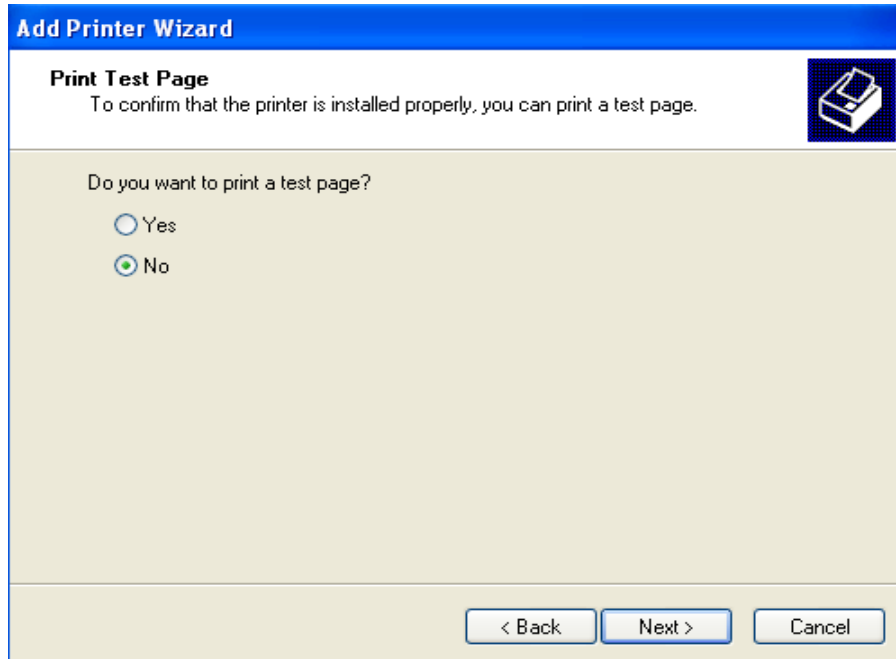

Figure 2-39: Print Test Page

Step 10: Click **FINISH** to complete the driver installation and exit the Installation Wizard.

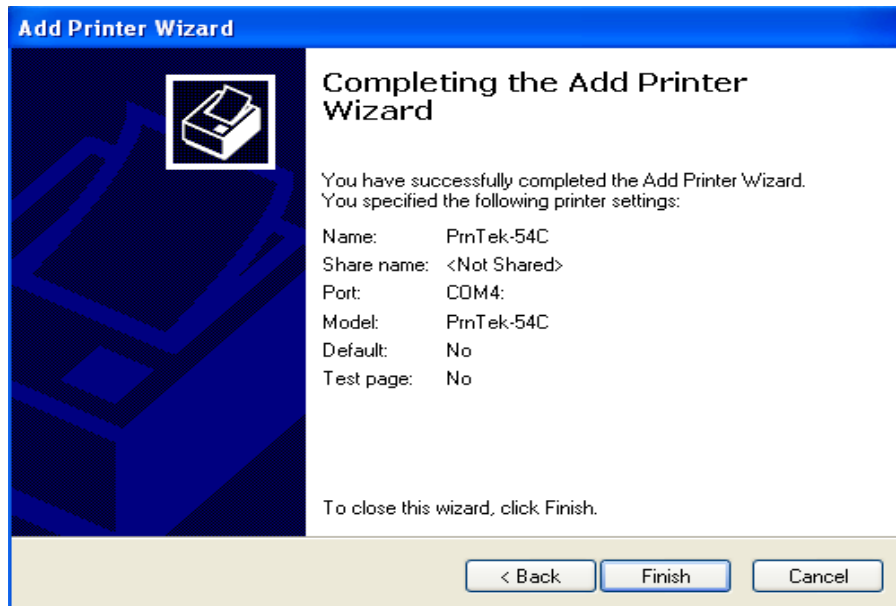

Figure 2-40: Printer Installation Complete

2.9.2.2 Setting the Communication Protocol

Step 1: Access the Printer and Faxes window by clicking “Printer and Faxes” option from the Start menu.



Figure 2-41: Access Printer and Faxes

Step 2: Right-click the printer icon in "Printers and Faxes", then select "Properties".

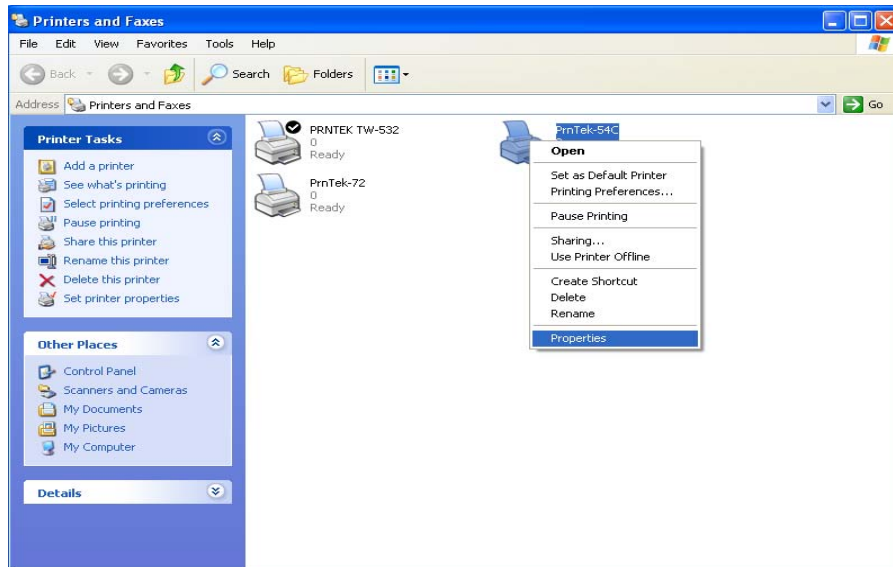

Figure 2-42: Printer Properties

Step 3: Click Ports tab. Select "COM5: Serial Port", then click "Configure Port..."

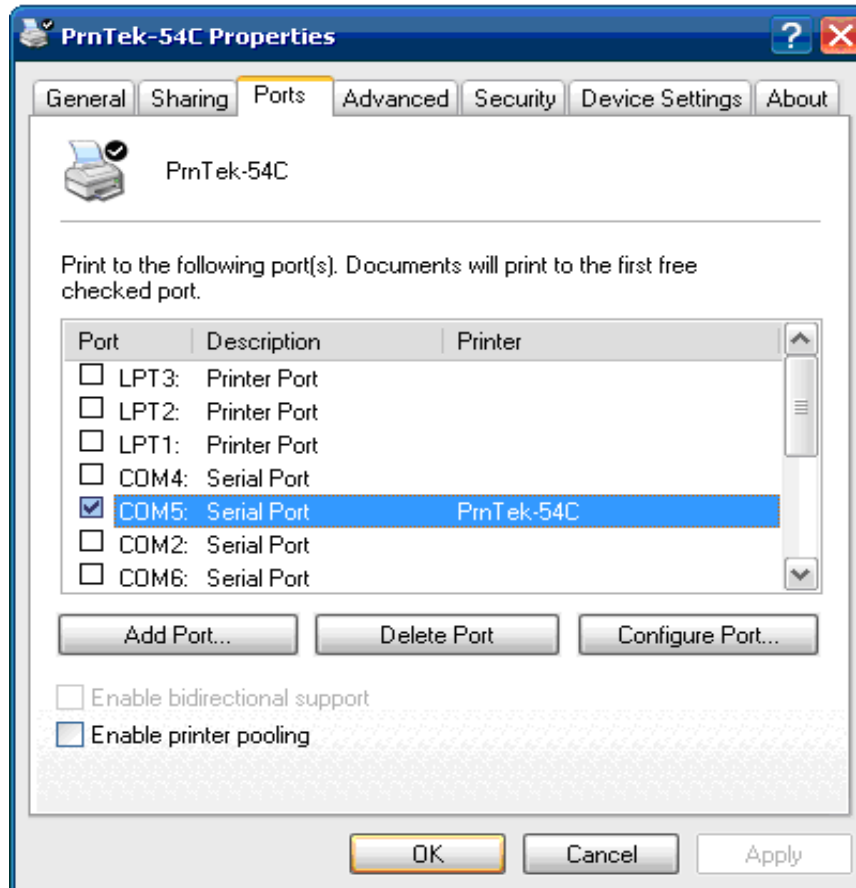

Figure 2-43: Configure Printer Port

EP-308A/EP-308AS POS

Step 4: Set the options in Figure 2-31 as shown below.

- Bits per second: 115200
- Data bits: 8
- Parity: None
- Stop bits: 1
- Flow control: Xon / Xoff

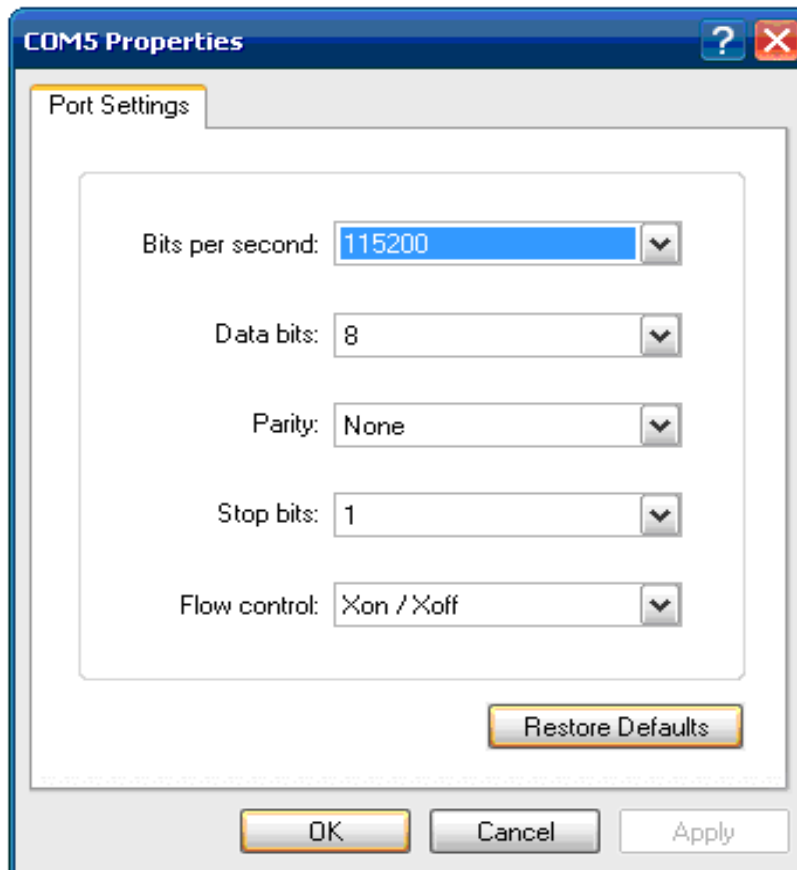

Figure 2-44: Set Communication Options

Step 5: Click OK to apply the changes.



WARNING:

The thermal printer will be destroyed if pulled, dragged or opened while printing.

Chapter

3

BIOS Setup

3.1 Introduction

The BIOS is programmed onto the BIOS chip. The BIOS setup program allows changes to certain system settings. This chapter outlines the options that can be changed.

3.1.1 Starting Setup

The AMI BIOS is activated when the computer is turned on. The setup program can be activated in one of two ways.

1. Press the **DELETE** key as soon as the system is turned on or
2. Press the **DELETE** key when the “**Press Del to enter SETUP**” message appears on the screen.

If the message disappears before the **DELETE** key is pressed, restart the computer and try again.

3.1.2 Using Setup

Use the arrow keys to highlight items, press **ENTER** to select, use the PageUp and PageDown keys to change entries, press **F1** for help and press **Esc** to quit. Navigation keys are shown in.

Key	Function
Up arrow	Move to previous item
Down arrow	Move to next item
Left arrow	Move to the item on the left hand side
Right arrow	Move to the item on the right hand side
Esc key	Main Menu – Quit and not save changes into CMOS Status Page Setup Menu and Option Page Setup Menu -- Exit current page and return to Main Menu
Page Up key	Increase the numeric value or make changes
Page Dn key	Decrease the numeric value or make changes
F1 key	General help, only for Status Page Setup Menu and Option Page Setup Menu

Key	Function
F2 /F3 key	Change color from total three colors. F2 to select color forward.
F10 key	Save all the CMOS changes, only for Main Menu

Table 3-1: BIOS Navigation Keys

3.1.3 Getting Help

When **F1** is pressed a small help window describing the appropriate keys to use and the possible selections for the highlighted item appears. To exit the Help Window press **Esc** or the **F1** key again.

3.1.4 Unable to Reboot After Configuration Changes

If the computer cannot boot after changes to the system configuration is made, reset CMOS defaults.

3.1.5 BIOS Menu Bar

The **menu bar** on top of the BIOS screen has the following main items:

- Main – Changes the basic system configuration.
- Advanced – Changes the advanced system settings.
- PCIPnP – Changes the advanced PCI/PnP Settings
- Boot – Changes the system boot configuration.
- Security – Sets User and Supervisor Passwords.
- Chipset – Changes the chipset settings.
- Exit – Selects exit options and loads default settings

The following sections completely describe the configuration options found in the menu items at the top of the BIOS screen and listed above.

3.2 Main

The **Main** BIOS menu (BIOS Menu 1) appears when the **BIOS Setup** program is entered. The **Main** menu gives an overview of the basic system information.

```

BIOS SETUP UTILITY
Main  Advanced  PCIPNP  Boot  Security  Chipset  Exit

System Overview
-----
AMIBIOS
Version      :08.00.15
Build Date   :12/08/08
ID:          :H436MR11

Processor
Genuine Intel® CPU N270 @ 1.60 GHz
Speed       :1600 MHz
Count       :1

System Memory
Size        :1016MB

System Time      [14:20:27]
System Time      [Tue 03/17/2009]

Use [ENTER], [TAB] or [SHIFT-TAB] to select a field.
Use [+] or [-] to configure system time.

←→ Select Screen
↑↓ Select Item
Enter Go to SubScreen
F1  General Help
F10 Save and Exit
ESC Exit

v02.61 ©Copyright 1985-2006, American Megatrends, Inc.

```

BIOS Menu 1: Main

- **System Overview**

The **System Overview** lists a brief summary of different system components. The fields in **System Overview** cannot be changed. The items shown in the system overview include:

- AMI BIOS: Displays auto-detected BIOS information
 - **Version:** Current BIOS version
 - **Build Date:** Date the current BIOS version was made
 - **ID:** Installed BIOS ID
- Processor: Displays auto-detected CPU specifications
 - **Type:** Names the currently installed processor
 - **Speed:** Lists the processor speed
 - **Count:** The number of CPUs on the motherboard
- System Memory: Displays the auto-detected system memory.
 - **Size:** Lists memory size

The System Overview field also has two user configurable fields:

- **System Time [xx:xx:xx]**

Use the **System Time** option to set the system time. Manually enter the hours, minutes and seconds.

- **System Date [xx/xx/xx]**

Use the **System Date** option to set the system date. Manually enter the day, month and year.

3.3 Advanced

Use the **Advanced** menu (BIOS Menu 2) to configure the CPU and peripheral devices

```

BIOS SETUP UTILITY
Main  Advanced  PCIPNP  Boot  Security  Chipset  Exit
-----
Advanced Settings                                Configure CPU
-----
WARNING: Setting wrong values in below sections may cause
system to malfunction

> CPU Configuration
> IDE Configuration
> SuperIO Configuration
> Hardware Health Configuration
> Power Configuration
> Remote Access Configuration
> USB Configuration

                                  ←→  Select Screen
                                  ↑↓  Select Item
                                  Enter Go to SubScreen
                                  F1   General Help
                                  F10  Save and Exit
                                  ESC  Exit

v02.61 ©Copyright 1985-2006, American Megatrends, Inc.

```

BIOS Menu 2: Advanced

EP-308A/EP-308AS POS

3.3.1 CPU Configuration

Use the **CPU Configuration** menu (BIOS Menu 3) to view detailed CPU specifications and configure the CPU.

```

BIOS SETUP UTILITY
Main  Advanced  PCIPNP  Boot  Security  Chipset  Exit
-----
Configure Advanced CPU Settings
Module Version:3F.12
-----
Manufacturer   :Intel@
Genuine Intel@ CPU N270 @ 1.60 GHz
Frequency      :1.60GHz
FSB Speed      :532MHz

Cache L1       : 24KB
Cache L2       : 512KB

Ratio Actual Value:12

<=> Select Screen
↑↓ Select Item
Enter Go to SubScreen
F1  General Help
F10 Save and Exit
ESC Exit

v02.61 ©Copyright 1985-2006, American Megatrends, Inc.

```

BIOS Menu 3: CPU Configuration

The CPU Configuration menu lists the following CPU details:

- Manufacturer: Lists the name of the CPU manufacturer
- Brand String: Lists the brand name of the CPU being used
- Frequency: Lists the CPU processing speed
- FSB Speed: Lists the FSB speed
- Cache L1: Lists the CPU L1 cache size
- Cache L2: Lists the CPU L2 cache size

3.3.2 IDE Configuration

Use the **IDE Configuration** menu (BIOS Menu 4) to change and/or set the configuration of the IDE devices installed in the system.

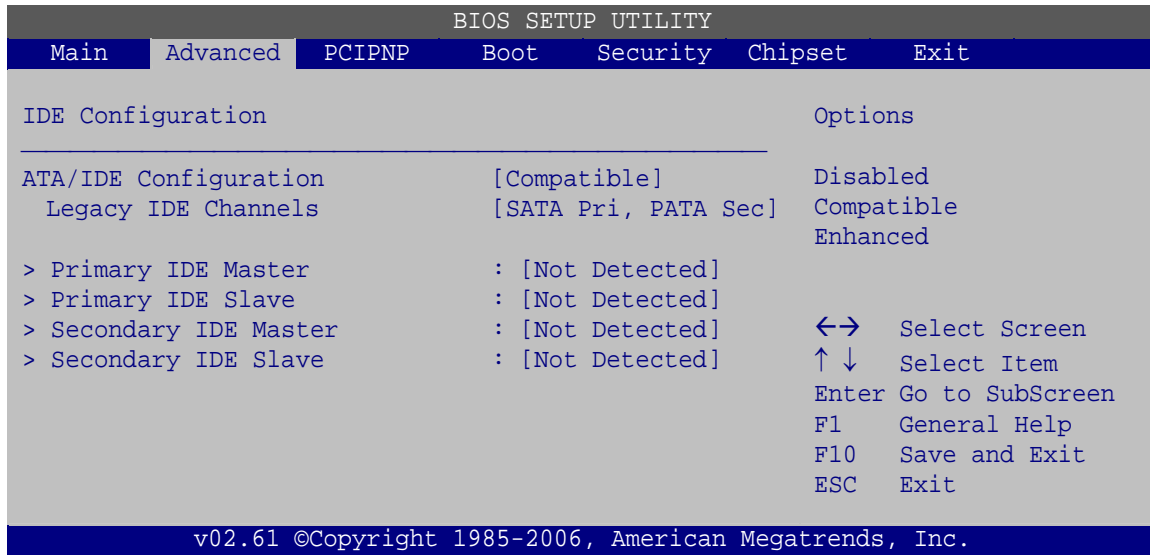

BIOS Menu 4: IDE Configuration

- **ATA/IDE Configuration [Compatible]**

Use the **ATA/IDE Configuration** option to configure the ATA/IDE controller.

- ➔ **Disabled** Disables the on-board ATA/IDE controller.
- ➔ **Compatible DEFAULT** The SATA drive is configured on an IDE channel.
- ➔ **Enhanced** Both IDE and SATA channels are configured separately.

- **Legacy IDE Channels [SATA Pri, PATA Sec]**

Use the **Legacy IDE Channels** option to configure SATA devices as normal IDE devices.

- ➔ **SATA Only** Only SATA drives are on the IDE channels. IDE drives are disabled
- ➔ **SATA Pri, DEFAULT** SATA drives are configured on the Primary IDE channel. IDE drives on the Secondary IDE channel
PATA Sec

EP-308A/EP-308AS POS

➔ **PATA Only** Only the IDE drives are enabled. SATA drives are disabled

- **Configure SATA as [IDE]**

Use the **Configure SATA as** option to configure SATA devices as normal IDE devices.

➔ **IDE DEFAULT** Configures SATA devices as normal IDE device.

➔ **RAID** Used when a RAID setup is installed

➔ **AHCI** Enables advanced SATA drive features

3.3.2.1 IDE Master, IDE Slave

Use the **IDE Master** and **IDE Slave** configuration menu to view both primary and secondary IDE device details and configure the IDE devices connected to the system.

```

BIOS SETUP UTILITY
Main  Advanced  PCIPNP  Boot  Security  Chipset  Exit
-----
Primary IDE Master                               Select the type
                                                of device connected
Device      :Not Detected                       to the system
-----
Type                [Auto]
LBA/Large Mode     [Auto]
Block (Multi-Sector Transfer) [Auto]
PIO Mode           [Auto]
DMA Mode           [Auto]
S.M.A.R.T.         [Auto]
32Bit Data Transfer [Enabled]
                                                ← Select Screen
                                                ↑ ↓ Select Item
                                                +- Change Option
F1 General Help
F10 Save and Exit
ESC Exit
v02.61 ©Copyright 1985-2006, American Megatrends, Inc.

```

BIOS Menu 5: IDE Master and IDE Slave Configuration

- **Auto-Detected Drive Parameters**

The “grayed-out” items in the left frame are IDE disk drive parameters automatically detected from the firmware of the selected IDE disk drive. The drive parameters are listed as follows:

- **Device:** Lists the device type (e.g. hard disk, CD-ROM etc.)

- **Type:** Indicates the type of devices a user can manually select
- **Vendor:** Lists the device manufacturer
- **Size:** List the storage capacity of the device.
- **LBA Mode:** Indicates whether the LBA (Logical Block Addressing) is a method of addressing data on a disk drive is supported or not.
- **Block Mode:** Block mode boosts IDE drive performance by increasing the amount of data transferred. Only 512 bytes of data can be transferred per interrupt if block mode is not used. Block mode allows transfers of up to 64 KB per interrupt.
- **PIO Mode:** Indicates the PIO mode of the installed device.
- **Async DMA:** Indicates the highest Asynchronous DMA Mode that is supported.
- **Ultra DMA:** Indicates the highest Synchronous DMA Mode that is supported.
- **S.M.A.R.T.:** Indicates whether or not the Self-Monitoring Analysis and Reporting Technology protocol is supported.
- **32Bit Data Transfer:** Enables 32-bit data transfer.

- **Type [Auto]**

Use the **Type** BIOS option select the type of device the AMIBIOS attempts to boot from after the Power-On Self-Test (POST) is complete.

- | | | |
|---|----------------------------|---|
| ➔ | Not Installed | BIOS is prevented from searching for an IDE disk drive on the specified channel. |
| ➔ | Auto DEFAULT | The BIOS auto detects the IDE disk drive type attached to the specified channel. This setting should be used if an IDE hard disk drive is attached to the specified channel. |
| ➔ | CD/DVD | The CD/DVD option specifies that an IDE CD-ROM drive is attached to the specified IDE channel. The BIOS does not attempt to search for other types of IDE disk drives on the specified channel. |

EP-308A/EP-308AS POS

➔ **ARMD** This option specifies an ATAPI Removable Media Device. These include, but are not limited to:

ZIP

LS-120

- **LBA/Large Mode [Auto]**

Use the **LBA/Large Mode** option to disable or enable BIOS to auto detects LBA (Logical Block Addressing). LBA is a method of addressing data on a disk drive. In LBA mode, the maximum drive capacity is 137 GB.

➔ **Disabled** BIOS is prevented from using the LBA mode control on the specified channel.

➔ **Auto** **DEFAULT** BIOS auto detects the LBA mode control on the specified channel.

- **Block (Multi Sector Transfer) [Auto]**

Use the **Block (Multi Sector Transfer)** to disable or enable BIOS to auto detect if the device supports multi-sector transfers.

➔ **Disabled** BIOS is prevented from using Multi-Sector Transfer on the specified channel. The data to and from the device occurs one sector at a time.

➔ **Auto** **DEFAULT** BIOS auto detects Multi-Sector Transfer support on the drive on the specified channel. If supported the data transfer to and from the device occurs multiple sectors at a time.

- **PIO Mode [Auto]**

Use the **PIO Mode** option to select the IDE PIO (Programmable I/O) mode program timing cycles between the IDE drive and the programmable IDE controller. As the PIO mode increases, the cycle time decreases.

- **Auto** **DEFAULT** BIOS auto detects the PIO mode. Use this value if the IDE disk drive support cannot be determined.
- **0** PIO mode 0 selected with a maximum transfer rate of 3.3 MB/s
- **1** PIO mode 1 selected with a maximum transfer rate of 5.2 MB/s
- **2** PIO mode 2 selected with a maximum transfer rate of 8.3 MB/s
- **3** PIO mode 3 selected with a maximum transfer rate of 11.1 MB/s
- **4** PIO mode 4 selected with a maximum transfer rate of 16.6 MB/s
(This setting generally works with all hard disk drives manufactured after 1999. For other disk drives, such as IDE CD-ROM drives, check the specifications of the drive.)

▪ **DMA Mode [Auto]**

Use the **DMA Mode** BIOS selection to adjust the DMA mode options.

- **Auto** **DEFAULT** BIOS auto detects the DMA mode. Use this value if the IDE disk drive support cannot be determined.
- **SWDMA0** Single Word DMA mode 0 selected with a maximum data transfer rate of 2.1 MB/s
- **SWDMA1** Single Word DMA mode 1 selected with a maximum data transfer rate of 4.2 MB/s
- **SWDMA2** Single Word DMA mode 2 selected with a maximum data transfer rate of 8.3 MB/s
- **MWDMA0** Multi Word DMA mode 0 selected with a maximum data transfer rate of 4.2 MB/s
- **MWDMA1** Multi Word DMA mode 1 selected with a maximum data transfer rate of 13.3 MB/s
- **MWDMA2** Multi Word DMA mode 2 selected with a maximum data transfer rate of 16.6 MB/s
- **UDMA0** Ultra DMA mode 0 selected with a maximum data transfer rate of 16.6 MB/s

EP-308A/EP-308AS POS

- ➔ **UDMA1** Ultra DMA mode 1 selected with a maximum data transfer rate of 25 MB/s
- ➔ **UDMA2** Ultra DMA mode 2 selected with a maximum data transfer rate of 33.3 MB/s
- ➔ **UDMA3** Ultra DMA mode 3 selected with a maximum data transfer rate of 44 MB/s (To use this mode, it is required that an 80-conductor ATA cable is used.)
- ➔ **UDMA4** Ultra DMA mode 4 selected with a maximum data transfer rate of 66.6 MB/s (To use this mode, it is required that an 80-conductor ATA cable is used.)
- ➔ **UDMA5** Ultra DMA mode 5 selected with a maximum data transfer rate of 99.9 MB/s (To use this mode, it is required that an 80-conductor ATA cable is used.)

- **S.M.A.R.T [Auto]**

Use the **S.M.A.R.T** option to auto-detect, disable or enable Self-Monitoring Analysis and Reporting Technology (SMART) on the drive on the specified channel. **S.M.A.R.T** predicts impending drive failures. The **S.M.A.R.T** BIOS option enables or disables this function.

- ➔ **Auto** **DEFAULT** BIOS auto detects HDD SMART support.
- ➔ **Disabled** Prevents BIOS from using the HDD SMART feature.
- ➔ **Enabled** Allows BIOS to use the HDD SMART feature

- **32Bit Data Transfer [Enabled]**

Use the **32Bit Data Transfer** BIOS option to enables or disable 32-bit data transfers.

- ➔ **Disabled** Prevents the BIOS from using 32-bit data transfers.
- ➔ **Enabled** **DEFAULT** Allows BIOS to use 32-bit data transfers on supported hard disk drives.

3.3.3 Super IO Configuration

Use the **Super IO Configuration** menu (BIOS Menu 6) to set or change the configurations for the FDD controllers, parallel ports and serial ports.

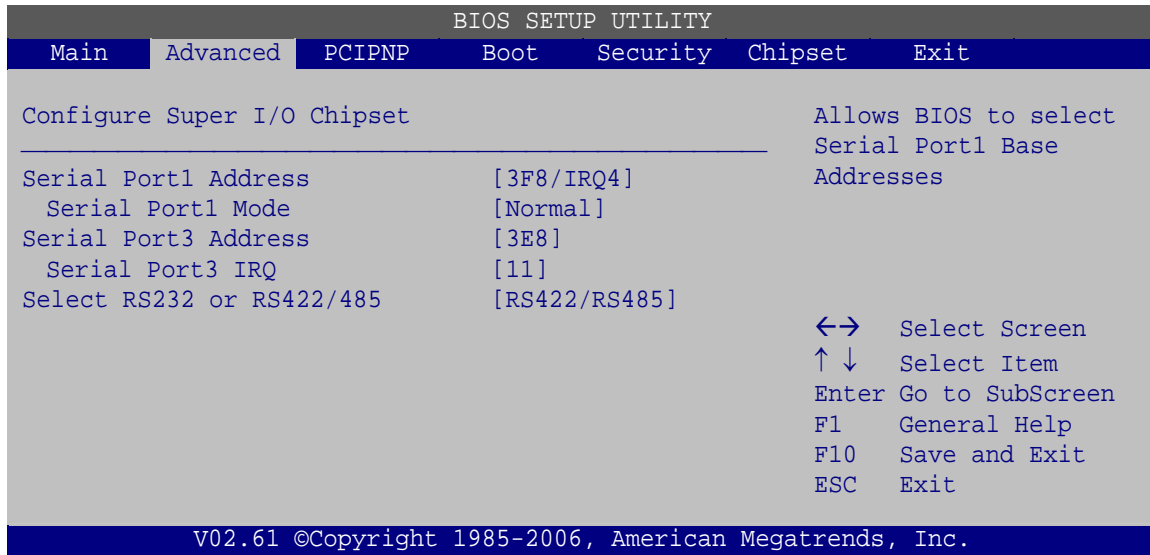

BIOS Menu 6: Super IO Configuration

- **Serial Port1 Address [3F8/IRQ4]**

Selects the serial port base address.

- ➔ **Disabled** No base address
- ➔ **3F8/IRQ4** **DEFAULT** I/O address 3F8 and interrupt address IRQ4
- ➔ **3E8/IRQ4** I/O address 3E8 and interrupt address IRQ4
- ➔ **2E8/IRQ3** I/O address 2E8 and interrupt address IRQ3

- **Serial Port1 Mode [Normal]**

Selects the mode for the serial port.

- ➔ **Normal** **DEFAULT** Normal mode
- ➔ **IrDA** IrDA mode
- ➔ **ASK IR** ASKIR mode

EP-308A/EP-308AS POS

- **Serial Port3 Address [3E8]**

Selects the serial port base address.

- ➔ **Disabled** No base address
- ➔ **3E8** **DEFAULT** I/O address 3E8
- ➔ **2E8** I/O address 2E8
- ➔ **2F0** I/O address 2F0
- ➔ **2E0** I/O address 2E0

- **Serial Port3 IRQ [11]**

Selects the serial port interrupt address.

- ➔ **10** IRQ address 10
- ➔ **11** **DEFAULT** IRQ address 11

- **Select RS232 or RS422/RS485 [RS/232]**

Select the communication method for Serial Port 3.

- ➔ **RS232** **DEFAULT** Serial Port 2 signaling mode is RS-232
- ➔ **RS485** Serial Port 2 signaling mode is RS-485
- ➔ **RS422** Serial Port 2 signaling mode is RS-422

3.3.4 Hardware Health Configuration

The **Hardware Health Configuration** menu (BIOS Menu 7) shows the operating temperature, fan speeds and system voltages.

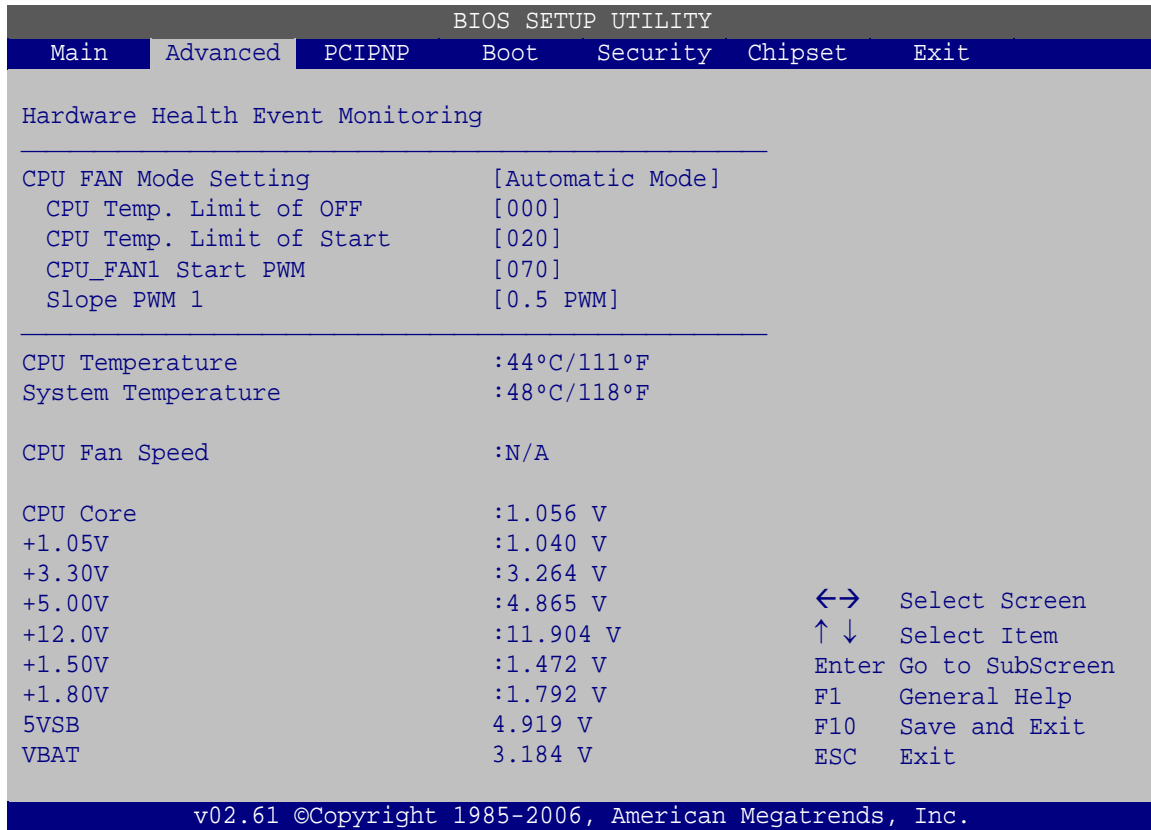

BIOS Menu 7: Hardware Health Configuration

- **Mode Setting [Full On Mode]**

Use the **Mode Setting** option to configure the second fan.

- ➔ **Full On Mode** **DEFAULT** Fan is on all the time
- ➔ **Automatic mode** The fan adjusts its speed using these settings:
 - Temp. Limit of OFF
 - Temp. Limit of Start
 - Fan Start PWM
 - Slope PWM 1

EP-308A/EP-308AS POS

➔ PWM Manual mode

The fan spins at the speed set in:
Fan PWM control

- **Temp. Limit of OFF [000]**



WARNING:

CPU failure can result if this value is set too high

The fan will turn off if the temperature falls below this value.

- Minimum Value: 0°C
- Maximum Value: 127°C

- **Temp. Limit of Start [020]**



WARNING:

CPU failure can result if this value is set too high

When the fan is off, it will only start when the temperature exceeds this setting.

- Minimum Value: 0°C
- Maximum Value: 127°C

- **Start PWM [070]**

This is the initial speed of the fan when it first starts spinning.

- PWM Minimum Mode: 0
- PWM Maximum Mode: 127

- **Slope PWM [1 PWM]**

A bigger value will increase the fan speed in big amounts. A smaller value will increase the speed more gradually.

- 0 PWM
 - 1 PWM
 - 2 PWM
 - 4 PWM
 - 8 PWM
 - 16 PWM
 - 32 PWM
 - 64 PWM
-
- **CPU Fan PWM Control [070]**

This value specifies the speed of the fan.

- PWM Minimum Mode: 0
- PWM Maximum Mode: 127

- **Monitored Values**

The following system parameters and values are shown. The system parameters that are monitored are:

- The following system temperatures are monitored:
 - CPU temperature
 - System temperature
- The following fan speeds are monitored:
 - CPU fan speed
 - SYS fan 1 speed
 - SYS fan 2 speed
- The following core voltages are monitored:
 - CPU core
 - +1.05V
 - +3.30V
 - +5.00V
 - +12.0V
 - +1.5V
 - +1.8V

EP-308A/EP-308AS POS

3.3.5 Power Configuration

The **Power Configuration** menu (BIOS Menu 8) allows the advanced power management options to be configured.

```

BIOS SETUP UTILITY
Main  Advanced  PCIPNP  Boot  Security  Chipset  Exit
-----
> ACPI Configuration
> APM Configuration

                                  ←→  Select Screen
                                  ↑↓  Select Item
                                  Enter Go to SubScreen
                                  F1   General Help
                                  F10  Save and Exit
                                  ESC  Exit

V02.61 ©Copyright 1985-2006, American Megatrends, Inc.
    
```

BIOS Menu 8: APM Configuration

3.3.5.1 ACPI Settings

Use the **ACPI Settings** menu (BIOS Menu 9) to select the ACPI state when the system is suspended.

```

BIOS SETUP UTILITY
Main  Advanced  PCIPNP  Boot  Security  Chipset  Exit
-----
ACPI Settings
-----
Suspend Mode                [S1 (POS)]

                                  ←→  Select Screen
                                  ↑↓  Select Item
                                  Enter Go to SubScreen
                                  F1   General Help
                                  F10  Save and Exit
                                  ESC  Exit

V02.61 ©Copyright 1985-2006, American Megatrends, Inc.
    
```

BIOS Menu 9: ACPI Settings

- **Suspend Mode [S1(POS)]**

Use the **Suspend Mode** option to specify the sleep state the system enters when it is not being used.

3.3.5.2 APM Configuration

The **APM Configuration** menu (BIOS Menu 10) allows the advanced power management options to be configured.

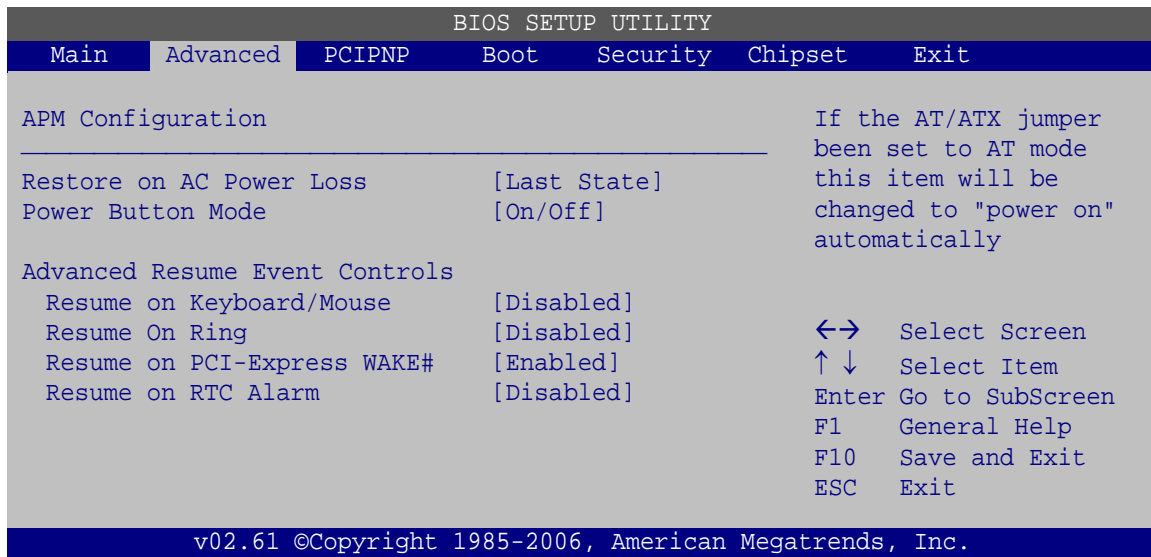

BIOS Menu 10: APM Configuration

- **Restore on AC Power Loss [Last State]**

Use the **Restore on AC Power Loss** BIOS option to specify what state the system returns to if there is a sudden loss of power to the system.

- ➔ **Power Off** The system remains turned off
- ➔ **Power On DEFAULT** The system turns on
- ➔ **Last State** The system returns to its previous state. If it was on, it turns itself on. If it was off, it remains off.

- **Power Button Mode [On/Off]**

Use the **Power Button Mode** BIOS to specify how the power button functions.

EP-308A/EP-308AS POS

- ➔ **On/Off** **DEFAULT** When the power button is pressed the system is either turned on or off
- ➔ **Suspend** When the power button is pressed the system goes into suspend mode

- **Resume on Keyboard/Mouse [Disabled]**

Use the **Resume on Keyboard/Mouse** BIOS option to enable activity on either the keyboard or mouse to rouse the system from a suspend or standby state. That is, the system is roused when the mouse is moved or a button on the keyboard is pressed.

- ➔ **Disabled** **DEFAULT** Wake event not generated by activity on the keyboard or mouse
- ➔ **Enabled** Wake event generated by activity on the keyboard or mouse

- **Resume on Ring [Disabled]**

Use the **Resume on Ring** BIOS option to enable activity on the RI (ring in) modem line to rouse the system from a suspend or standby state. That is, the system will be roused by an incoming call on a modem.

- ➔ **Disabled** **DEFAULT** Wake event not generated by an incoming call
- ➔ **Enabled** Wake event generated by an incoming call

- **Resume on PCI-Express WAKE# [Enabled]**

The **Resume on PCI-Express WAKE#** BIOS option specifies if the system is roused from a suspended or standby state when there is activity on the PCI-Express bus.

- ➔ **Disabled** Wake event not generated by PCI-Express activity
- ➔ **Enabled** **DEFAULT** Wake event generated by PCI-Express activity

- **Resume On RTC Alarm [Disabled]**

Use the **Resume On RTC Alarm** option to specify the time the system should be roused from a suspended state.

- ➔ **Disabled** **DEFAULT** The real time clock (RTC) cannot generate a wake event

- ➔ **Enabled** If selected, the following appears with values that can be selected:
 RTC Alarm Date (Days)
 System Time
 After setting the alarm, the computer turns itself on from a suspend state when the alarm goes off.

3.3.6 Remote Access Configuration

Use the **Remote Access Configuration** menu (BIOS Menu 11) to configure remote access parameters. The **Remote Access Configuration** is an AMIBIOS feature and allows a remote host running a terminal program to display and configure the BIOS settings.

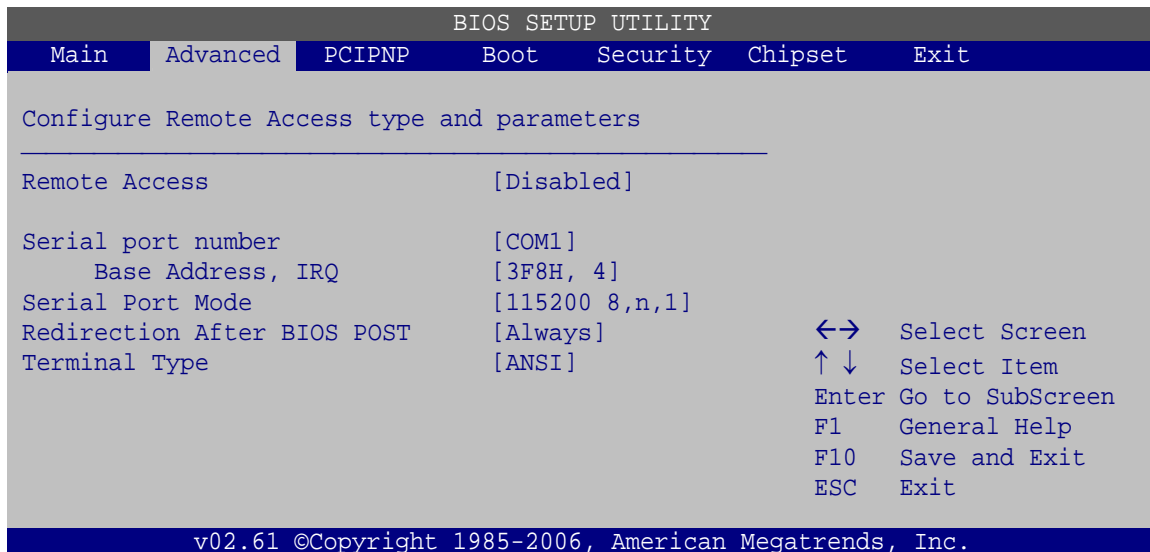

BIOS Menu 11: Remote Access Configuration

EP-308A/EP-308AS POS

- **Remote Access [Disabled]**

Use the **Remote Access** option to enable or disable access to the remote functionalities of the system.

- ➔ **Disabled** **DEFAULT** Remote access is disabled.
- ➔ **Enabled** Remote access configuration options shown below appear:

Serial Port Number

Serial Port Mode

Flow Control

Redirection after BIOS POST

Terminal Type

VT-UTF8 Combo Key Support

These configuration options are discussed below.

- **Serial Port Number [COM1]**

Use the **Serial Port Number** option allows to select the serial port used for remote access.

- ➔ **COM1** **DEFAULT** System is remotely accessed through COM1
- ➔ **COM2** System is remotely accessed through COM2

NOTE: Make sure the selected COM port is enabled through the Super I/O configuration menu.

- **Base Address, IRQ [2F8h,3]**

The **Base Address, IRQ** option cannot be configured and only shows the interrupt address of the serial port listed above.

- **Serial Port Mode [115200 8,n,1]**

Use the **Serial Port Mode** option to select baud rate through which the console redirection is made. The following configuration options are available

- 115200 8,n,1 **DEFAULT**
- 57600 8,n,1
- 38400 8,n,1
- 19200 8,n,1
- 09600 8,n,1

NOTE:

Identical baud rate setting must be set on the host (a management computer running a terminal software) and the slave

- **Flow Control [None]**

Use the **Flow Control** option to report the flow control method for the console redirection application.

- ➔ **None** **DEFAULT** No control flow,
- ➔ **Hardware** Hardware is set as the console redirection
- ➔ **Software** Software is set as the console redirection

- **Redirection After BIOS POST [Always]**

Use the **Redirection After BIOS POST** option to specify when console redirection should occur.

- ➔ **Disabled** The console is not redirected after POST
- ➔ **Boot Loader** Redirection is active during POST and during Boot Loader
- ➔ **Always** **DEFAULT** Redirection is always active (Some OSes may not work if set to Always)

- **Terminal Type [ANSI]**

Use the **Terminal Type** BIOS option to specify the remote terminal type.

EP-308A/EP-308AS POS

- ➔ **ANSI** **DEFAULT** The target terminal type is ANSI
- ➔ **VT100** The target terminal type is VT100
- ➔ **VT-UTF8** The target terminal type is VT-UTF8

- **VT-UTF8 Combo Key Support [Disabled]**

Use the **VT-UFT8 Combo Key Support** option to enable additional keys that are not provided by VT100 for the PC 101 keyboard.

The VT100 Terminal Definition is the standard convention used to configure and conduct emergency management tasks with UNIX-based servers. VT100 does not support all keys on the standard PC 101-key layout, however. The VT-UTF8 convention makes available additional keys that are not provided by VT100 for the PC 101 keyboard.

- ➔ **Disabled** **DEFAULT** Disables the VT-UTF8 terminal keys
- ➔ **Enabled** Enables the VT-UTF8 combination key. Support for ANSI/VT100 terminals

- **Sredir Memory Display Delay [Disabled]**

Use the **Sredir Memory Display Delay** option to select the delay before memory information is displayed. Configuration options are listed below

- No Delay **DEFAULT**
- Delay 1 sec
- Delay 2 sec
- Delay 4 sec

3.3.7 USB Configuration

Use the **USB Configuration** menu (BIOS Menu 12) to read USB configuration information and configure the USB settings.

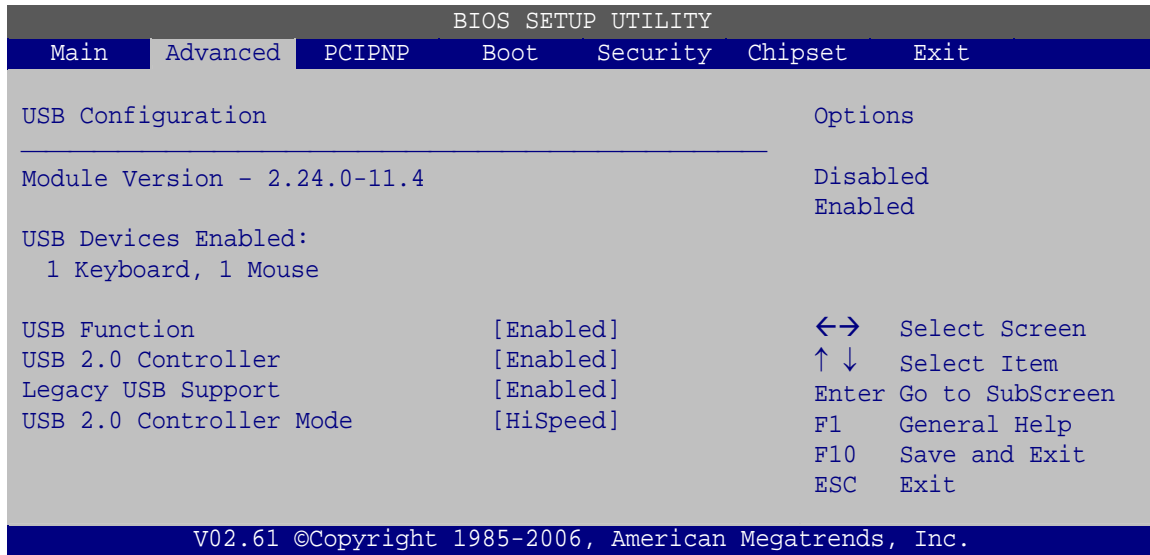

BIOS Menu 12: USB Configuration

- **USB Configuration**

The **USB Configuration** field shows the system USB configuration. The items listed are:

- Module Version: x.xxxxx.xxxxx

- **USB Devices Enabled**

The **USB Devices Enabled** field lists the USB devices that are enabled on the system

- **USB Function [Enabled]**

Use the **USB Function** BIOS option to enable or disable USB function support.

- ➔ **Disabled** USB function support disabled
- ➔ **Enabled** **DEFAULT** USB function support enabled

EP-308A/EP-308AS POS

- **USB 2.0 Controller [Enabled]**

Use the **USB 2.0 Controller** BIOS option to enable or disable the USB 2.0 controller

- ➔ **Disabled** USB 2.0 controller disabled
- ➔ **Enabled DEFAULT** USB 2.0 controller enabled

- **Legacy USB Support [Enabled]**

Use the **Legacy USB Support** BIOS option to enable USB mouse and USB keyboard support.

Normally if this option is not enabled, any attached USB mouse or USB keyboard does not become available until a USB compatible operating system is fully booted with all USB drivers loaded. When this option is enabled, any attached USB mouse or USB keyboard can control the system even when there is no USB driver loaded onto the system.

- ➔ **Disabled** Legacy USB support disabled
- ➔ **Enabled DEFAULT** Legacy USB support enabled
- ➔ **Auto** Legacy USB support disabled if no USB devices are connected

- **USB2.0 Controller Mode [HiSpeed]**

Use the **USB2.0 Controller Mode** option to set the speed of the USB2.0 controller.

- ➔ **FullSpeed** The controller is capable of operating at 12 Mb/s
- ➔ **HiSpeed DEFAULT** The controller is capable of operating at 480 Mb/s

3.3.7.1 USB Mass Storage Device Configuration

Use the **USB Mass Storage Device Configuration** menu (BIOS Menu 13) to configure USB mass storage class devices.

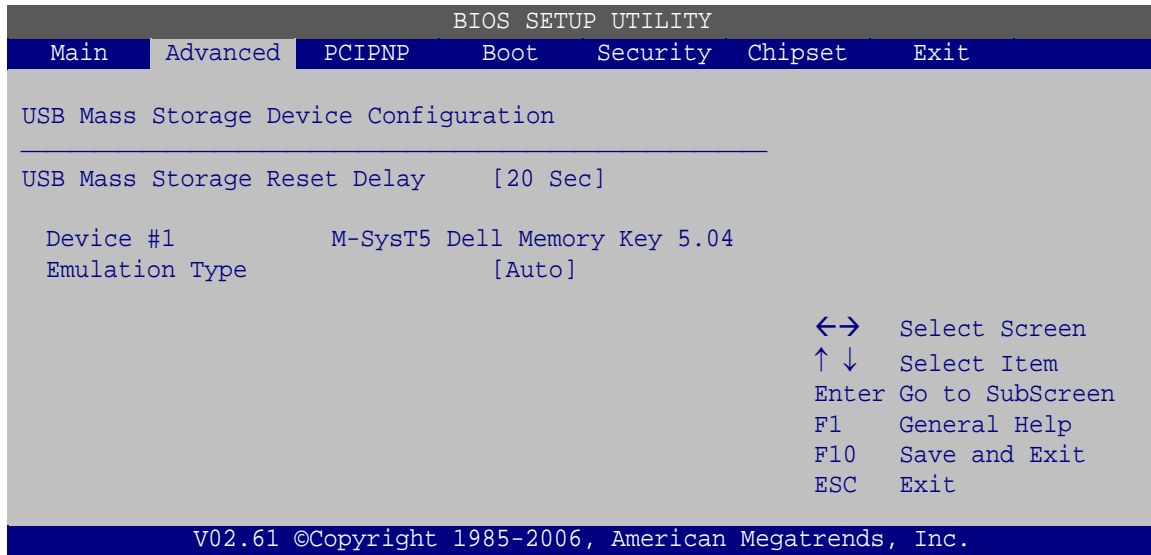

BIOS Menu 13: USB Mass Storage Device Configuration

- **USB Mass Storage Reset Delay [20 Sec]**

Use the **USB Mass Storage Reset Delay** option to set the number of seconds POST waits for the USB mass storage device after the start unit command.

- ➔ **10 Sec** POST waits 10 seconds for the USB mass storage device after the start unit command.
- ➔ **20 Sec** **DEFAULT** POST waits 20 seconds for the USB mass storage device after the start unit command.
- ➔ **30 Sec** POST waits 30 seconds for the USB mass storage device after the start unit command.
- ➔ **40 Sec** POST waits 40 seconds for the USB mass storage device after the start unit command.

- **Device ##**

The **Device##** field lists the USB devices that are connected to the system.

EP-308A/EP-308AS POS

- **Emulation Type [Auto]**

Use the **Emulation Type** BIOS option to specify the type of emulation BIOS has to provide for the USB device.

- ➔ **Auto** **DEFAULT** BIOS auto-detects the current USB.
- ➔ **Floppy** The USB device will be emulated as a floppy drive. The device can be either A: or B: responding to INT13h calls that return DL = 0 or DL = 1 respectively.
- ➔ **Forced FDD** Allows a hard disk image to be connected as a floppy image. This option works only for drives formatted with FAT12, FAT16 or FAT32.
- ➔ **Hard Disk** Allows the USB device to be emulated as hard disk responding to INT13h calls that return DL values of 80h or above.
- ➔ **CDROM** Assumes the CD-ROM is formatted as bootable media. All the devices that support block sizes greater than 512 bytes can only be booted using this option.

3.4 PCI/PnP

Use the **PCI/PnP** menu (BIOS Menu 14) to configure advanced PCI and PnP settings.



WARNING!

Setting wrong values for the BIOS selections in the PCIPnP BIOS menu may cause the system to malfunction.



BIOS Menu 14: PCI/PnP Configuration

- **IRQ# [Available]**

Use the **IRQ#** address to specify what IRQs can be assigned to a particular peripheral device.

- ➔ **Available** **DEFAULT** The specified IRQ is available to be used by PCI/PnP devices
- ➔ **Reserved** The specified IRQ is reserved for use by Legacy ISA devices

Available IRQ addresses are:

- IRQ3
- IRQ4
- IRQ5
- IRQ7
- IRQ9

EP-308A/EP-308AS POS

- IRQ10
- IRQ 11
- IRQ 14
- IRQ 15

- **DMA Channel# [Available]**

Use the **DMA Channel#** option to assign a specific DMA channel to a particular PCI/PnP device.

- ➔ **Available** **DEFAULT** The specified DMA is available to be used by PCI/PnP devices
- ➔ **Reserved** The specified DMA is reserved for use by Legacy ISA devices

Available DMA Channels are:

- DM Channel 0
- DM Channel 1
- DM Channel 3
- DM Channel 5
- DM Channel 6
- DM Channel 7

- **Reserved Memory Size [Disabled]**

Use the **Reserved Memory Size** BIOS option to specify the amount of memory that should be reserved for legacy ISA devices.

- ➔ **Disabled** **DEFAULT** No memory block reserved for legacy ISA devices
- ➔ **16K** 16 KB reserved for legacy ISA devices
- ➔ **32K** 32 KB reserved for legacy ISA devices
- ➔ **64K** 54 KB reserved for legacy ISA devices

3.5 Boot

Use the **Boot** menu (BIOS Menu 15) to configure system boot options.

```

BIOS SETUP UTILITY
Main  Advanced  PCIPNP  Boot  Security  Chipset  Exit
-----
Boot Settings                                     Configure settings
                                                during system boot.
> Boot Settings Configuration
> Boot Device Priority
> Hard Disk Drives
> CD/DVD Drives
> Removable Drives
                                                ←→  Select Screen
                                                ↑↓  Select Item
Enter  Go to SubScreen
F1    General Help
F10   Save and Exit
ESC   Exit

v02.61 ©Copyright 1985-2006, American Megatrends, Inc.

```

BIOS Menu 15: Boot

3.5.1 Boot Settings Configuration

Use the **Boot Settings Configuration** menu (BIOS Menu 16) to configure advanced system boot options.

```

BIOS SETUP UTILITY
Main  Advanced  PCIPNP  Boot  Security  Chipset  Exit
-----
Boot Settings Configuration                   Allows BIOS to skip
                                                certain tests while
Quick Boot                                   [Enabled]                    booting. This will
Quiet Boot                                   [Enabled]                    decrease the time
AddOn ROM Display Mode                       [Force BIOS]                 needed to boot the
Bootup Num-Lock                               [On]                          system.
Boot From LAN Support                         [Disabled]
Spread Spectrum Function                      [Disabled]
                                                ←→  Select Screen
                                                ↑↓  Select Item
Enter  Go to SubScreen
F1    General Help
F10   Save and Exit
ESC   Exit

v02.61 ©Copyright 1985-2006, American Megatrends, Inc.

```

BIOS Menu 16: Boot Settings Configuration

EP-308A/EP-308AS POS

- **Quick Boot [Enabled]**

Use the **Quick Boot** BIOS option to make the computer speed up the boot process.

- ➔ **Disabled** No POST procedures are skipped
- ➔ **Enabled DEFAULT** Some POST procedures are skipped to decrease the system boot time

- **Quiet Boot [Enabled]**

Use the **Quiet Boot** BIOS option to select the screen display when the system boots.

- ➔ **Disabled DEFAULT** Normal POST messages displayed
- ➔ **Enabled** OEM Logo displayed instead of POST messages

- **AddOn ROM Display Mode [Force BIOS]**

Use the **AddOn ROM Display Mode** option to allow add-on ROM (read-only memory) messages to be displayed.

- ➔ **Force BIOS DEFAULT** The system forces third party BIOS to display during system boot.
- ➔ **Keep Current** The system displays normal information during system boot.

- **Bootup Num-Lock [On]**

Use the **Bootup Num-Lock** BIOS option to specify if the number lock setting must be modified during boot up.

- ➔ **Off** Does not enable the keyboard Number Lock automatically. To use the 10-keys on the keyboard, press the Number Lock key located on the upper left-hand corner of the 10-key pad. The Number Lock LED on the keyboard lights up when the Number Lock is engaged.

- ➔ **On** **DEFAULT** Allows the Number Lock on the keyboard to be enabled automatically when the computer system boots up. This allows the immediate use of the 10-key numeric keypad located on the right side of the keyboard. To confirm this, the Number Lock LED light on the keyboard is lit.

- **Boot From LAN Support [Disabled]**

Use the **BOOT From LAN Support** option to enable the system to be booted from a remote system.

- ➔ **Disabled** **DEFAULT** Cannot be booted from a remote system through the LAN
- ➔ **Enabled** **DEFAULT** Can be booted from a remote system through the LAN

- **Spread Spectrum Mode [Disabled]**

The **Spread Spectrum Mode** option can help to improve CPU EMI issues.

- ➔ **Disabled** **DEFAULT** The spread spectrum mode is disabled
- ➔ **Enabled** The spread spectrum mode is enabled

EP-308A/EP-308AS POS

3.5.2 Boot Device Priority

Use the **Boot Device Priority** menu (BIOS Menu 17) to specify the boot sequence from the available devices. The drive sequence also depends on the boot sequence in the individual device section.

```

BIOS SETUP UTILITY
Main  Advanced  PCIPNP  Boot  Security  Chipset  Exit
-----
Boot Device Priority                               Specifies the boot
                                                  sequence from the
                                                  available devices.
> 1st Boot Device                               [1st Boot Device]
> 2nd Boot Device                               [2nd Boot Device]
> 3rd Boot Device                               [3rd Boot Device]

<=> Select Screen
↑↓ Select Item
Enter Go to SubScreen
F1 General Help
F10 Save and Exit
ESC Exit

v02.61 ©Copyright 1985-2006, American Megatrends, Inc.

```

BIOS Menu 17: Boot Device Priority Settings

3.5.3 Hard Disk Drives

Use the **Hard Disk Drives** menu to specify the boot sequence of the available HDDs. Only installed hard drives are shown.

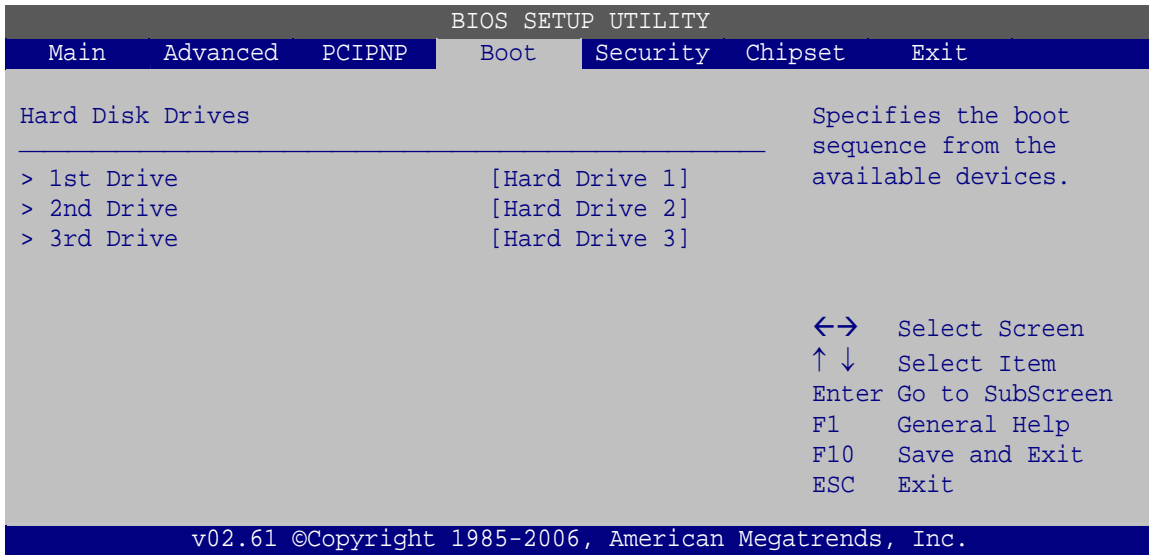

BIOS Menu 18: Hard Disk Drives

3.5.4 Removable Drives

Use the **Removable Drives** menu (BIOS Menu 19) to specify the boot sequence of the removable drives. Only connected drives are shown.

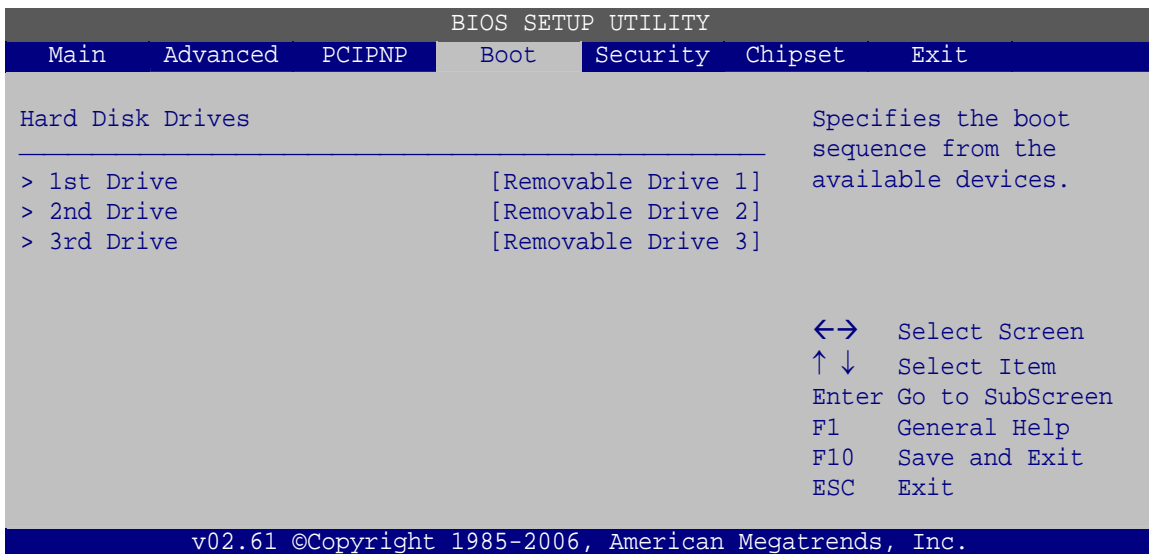

BIOS Menu 19: Removable Drives

3.5.5 CD/DVD Drives

Use the **CD/DVD Drives** menu to specify the boot sequence of the available CD/DVD drives. When the menu is opened, the CD drives and DVD drives connected to the system are listed as shown below:

- 1st Drive [CD/DVD: PM-(part ID)]
- 2nd Drive [HDD: PS-(part ID)]
- 3rd Drive [HDD: SM-(part ID)]
- 4th Drive [HDD: SM-(part ID)]



NOTE:

Only the drives connected to the system are shown. For example, if only two CDs or DVDs are connected only “**1st Drive**” and “**2nd Drive**” are listed.

The boot sequence from the available devices is selected. If the “**1st Drive**” option is selected a list of available CD/DVD drives is shown. Select the first CD/DVD drive the system boots from. If the “**1st Drive**” is not used for booting this option may be disabled.

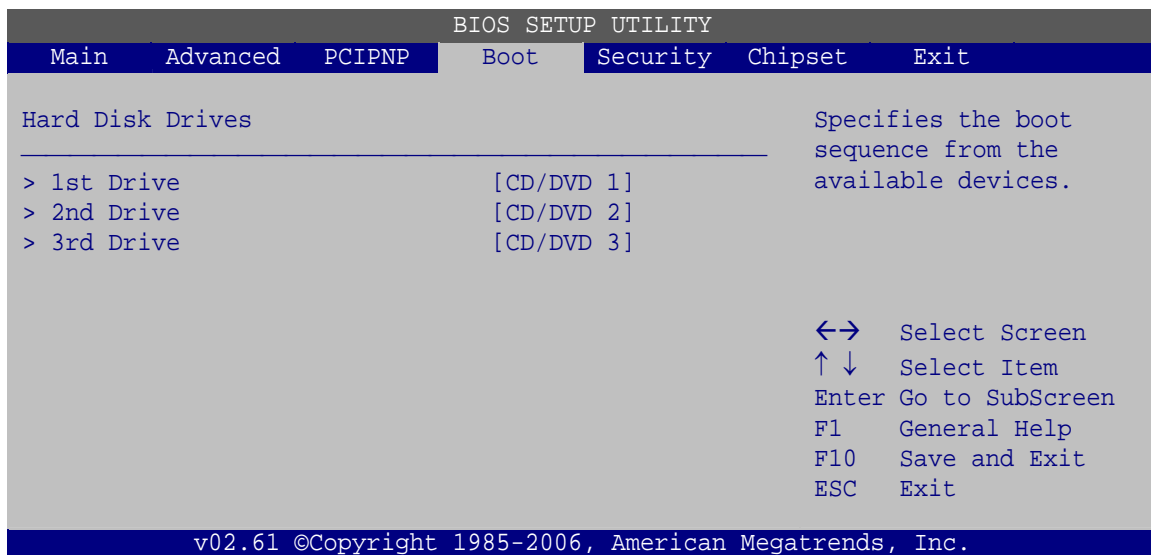

BIOS Menu 20: CD/DVD Drives

3.6 Security

Use the **Security** menu (BIOS Menu 21) to set system and user passwords.

```

                                BIOS SETUP UTILITY
  Main  Advanced  PCIPNP  Boot  Security  Chipset  Exit
-----
Security Settings
-----
Supervisor Password   :Not Installed
User Password        :Not Installed

Change Supervisor Password
Change User Password

                                  ←→  Select Screen
                                  ↑↓  Select Item
                                  Enter Go to SubScreen
                                  F1   General Help
                                  F10  Save and Exit
                                  ESC  Exit

v02.61 ©Copyright 1985-2006, American Megatrends, Inc.
  
```

BIOS Menu 21: Security

- **Change Supervisor Password**

Use the **Change Supervisor Password** to set or change a supervisor password. The default for this option is **Not Installed**. If a supervisor password must be installed, select this field and enter the password. After the password has been added, **Install** appears next to **Change Supervisor Password**.

- **Change User Password**

Use the **Change User Password** to set or change a user password. The default for this option is **Not Installed**. If a user password must be installed, select this field and enter the password. After the password has been added, **Install** appears next to **Change User Password**.

3.7 Chipset

Use the **Chipset** menu (BIOS Menu 22) to access the Northbridge and Southbridge configuration menus



WARNING!

Setting the wrong values for the Chipset BIOS selections in the Chipset BIOS menu may cause the system to malfunction.

```
BIOS SETUP UTILITY
Main  Advanced  PCIPNP  Boot  Security  Chipset  Exit
-----
Chipset
-----
> Northbridge Configuration
> Southbridge Configuration

                                  ←→  Select Screen
                                  ↑↓  Select Item
                                  Enter Go to SubScreen
                                  F1   General Help
                                  F10  Save and Exit
                                  ESC  Exit

v02.61 ©Copyright 1985-2006, American Megatrends, Inc.
```

BIOS Menu 22: Chipset

3.7.1 Northbridge Configuration

Use the **Northbridge Chipset Configuration** menu (BIOS Menu 23) to configure the Northbridge chipset.

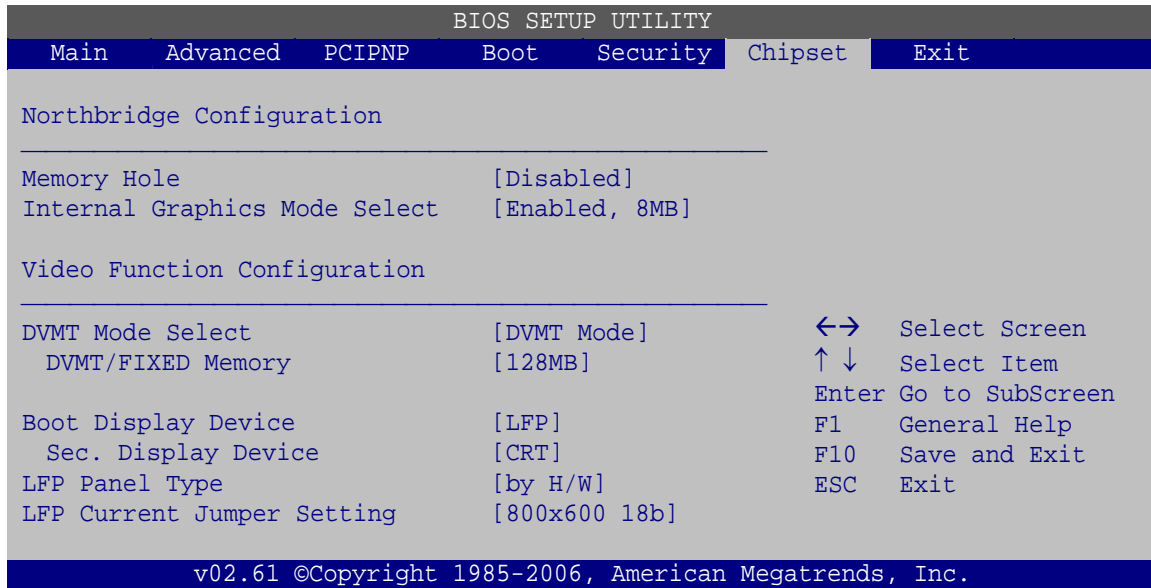

BIOS Menu 23: Northbridge Chipset Configuration

- **Memory Hole [Disabled]**

Use the **Memory Hole** option to reserve memory space between 15 MB and 16 MB for ISA expansion cards that require a specified area of memory to work properly. If an older ISA expansion card is used, please refer to the documentation that came with the card to see if it is necessary to reserve the space.

- ➔ **Disabled** **DEFAULT** Memory is not reserved for ISA expansion cards
- ➔ **15 MB–16 MB** Between 15 MB and 16 MB of memory is reserved for ISA expansion cards

- **Internal Graphics Mode Select [Enable, 8 MB]**

Use the **Internal Graphic Mode Select** option to specify the amount of system memory that can be used by the Internal graphics device.

- ➔ **Disable** Disabled the onboard graphics

EP-308A/EP-308AS POS

- ➔ **Enable, 1 MB** Dedicates 1 MB of main memory for graphics
- ➔ **Enable, 8 MB** **DEFAULT** Dedicated 8 MB of main memory for graphics

- **DVMT Mode Select [DVMT Mode]**

Use the **DVMT Mode Select** option to select the Intel Dynamic Video Memory Technology (DVMT) operating mode.

- ➔ **Fixed Mode** A fixed portion of graphics memory is reserved as graphics memory.
- ➔ **DVMT Mode** **DEFAULT** Graphics memory is dynamically allocated according to the system and graphics needs.
- ➔ **Combo Mode** A fixed portion of graphics memory is reserved as graphics memory. If more memory is needed, graphics memory is dynamically allocated according to the system and graphics needs.

- **DVMT/FIXED Memory [128 MB]**

Use the **DVMT/FIXED Memory** option to specify the maximum amount of memory that can be allocated as graphics memory. This option can only be configured for if **DVMT Mode** or **Fixed Mode** is selected in the **DVMT Mode Select** option. If **Combo Mode** is selected, the maximum amount of graphics memory is 128 MB. Configuration options are listed below.

- 64 MB
- 128 MB **DEFAULT**
- Maximum DVMT

- **Boot Display Device [Auto]**

Selects which graphics output to use first after the system is turned on. Auto selects the first available device.

- Auto **DEFAULT**
- CRT

- LVDS

- **Panel Type**

Use the **Panel Type** to determine the LCD panel resolution. Configuration options are listed below:

- 1024x768 24b
- 1280x1024 48b
- 1366x768 24b
- 1440x900 48b
- BY HARDWARE **DEFAULT**

- **Current Jumper Setting**

Shows current value of the hardware jumper setting for the LVDS resolution. This is the value used when "BY HARDWARE" is selected in the setting above.

3.7.2 Southbridge Configuration

The **Southbridge Configuration** menu (BIOS Menu 24) the Southbridge chipset to be configured.

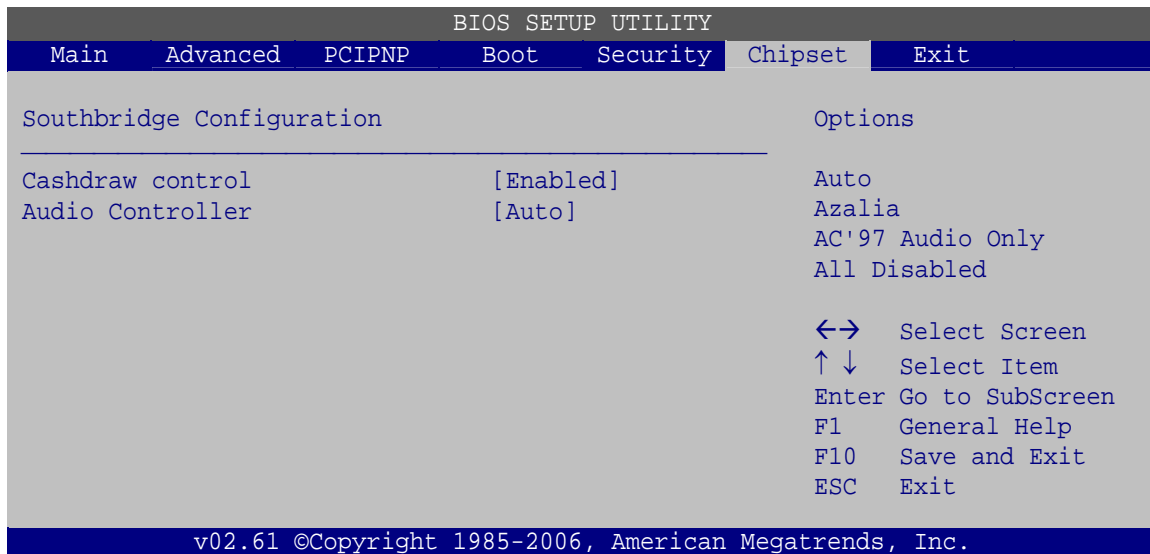

BIOS Menu 24:Southbridge Chipset Configuration

EP-308A/EP-308AS POS

- **Cashdraw Control [Enabled]**

Use the **Cashdraw Control** option to enable or disable the port that controls the cashdraw.

- Enabled **DEFAULT**
- Disabled

- **Audio Controller [Auto]**

Use the **HDA Controller** option to enable or disable High Definition audio codec.

- ➔ **Auto** **DEFAULT**
- ➔ **Azalia** Enabled High Definition audio
- ➔ **AC'97 Audio Only** Enable AC'97 audio
- ➔ **All disabled** No audio

3.8 Exit

Use the **Exit** menu (BIOS Menu 25) to load default BIOS values, optimal failsafe values and to save configuration changes.

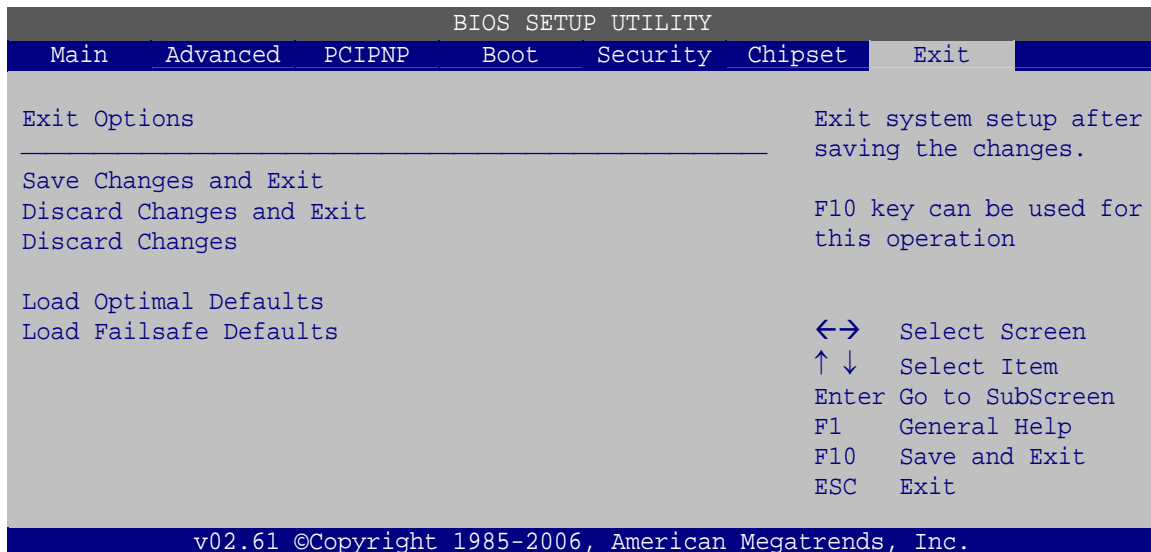

BIOS Menu 25:Exit

- **Save Changes and Exit**

Use the **Save Changes and Exit** option to save the changes made to the BIOS options and to exit the BIOS configuration setup program.

- **Discard Changes and Exit**

Use the **Discard Changes and Exit** option to exit the BIOS configuration setup program without saving the changes made to the system.

- **Discard Changes**

Use the **Discard Changes** option to discard the changes and remain in the BIOS configuration setup program.

- **Load Optimal Defaults**

Use the **Load Optimal Defaults** option to load the optimal default values for each of the parameters on the Setup menus. **F9 key can be used for this operation.**

- **Load Failsafe Defaults**

Use the **Load Failsafe Defaults** option to load failsafe default values for each of the parameters on the Setup menus. **F8 key can be used for this operation.**

Chapter

4

System Maintenance

4.1 System Maintenance Introduction

If the components of the EP-308A/EP-308AS fail they must be replaced, such as the wireless LAN module or the motherboard. Please contact the system reseller or vendor to purchase the replacement parts. Back cover removal instructions and jumper settings for the EP-308A/EP-308AS are described below.

4.2 Motherboard Replacement

In the case of motherboard failure, please contact an IEL sales representative, reseller or system vendor. The motherboard is accessible after opening the rear cover.

4.3 Cover Removal



WARNING!

Turn off the power before removing the bottom cover. Risk of electrocution. Severe damage to the product and injury to the body may occur if internal parts are touched while the power is still on.

The bottom cover of the EP-308A/EP-308AS must be removed. To remove the bottom cover, remove the screws then lift the cover off.

EP-308A/EP-308AS POS

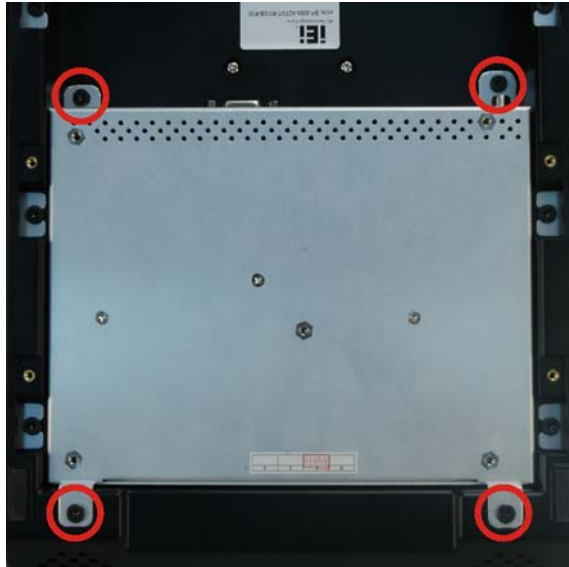

Figure 4-1: Bottom Cover Retention Screws

4.4 Memory Module Replacement

The flat panel PC has a preinstalled memory module. If the memory module fails, take the steps below to replace it.

- Step 1:** Remove the back cover. See **Section 4.3** above.
- Step 2:** Locate the memory module on the motherboard of the flat panel PC
- Step 3:** Remove the memory module by pulling both the spring retainer clips outward from the socket.
- Step 4:** Grasp the memory module by the edges and carefully pull it out of the socket.
- Step 5:** Install the new memory module by inserting it at an angle, then pushing down until the clips snap into place (Figure 4-2).

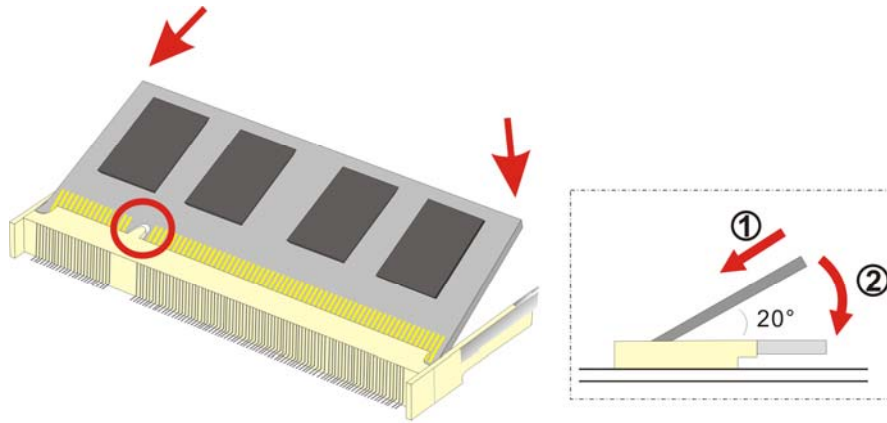

Figure 4-2: DDR SO-DIMM Module Installation

4.5 Hard Drive and CompactFlash® Replacement

To replace the hard drive or CompactFlash® card, please refer to the hard drive and CompactFlash® installation sections.

Appendix

A

Safety Precautions

**WARNING:**

The precautions outlined in this chapter should be strictly followed. Failure to follow these precautions may result in permanent damage to the EP-308A/EP-308AS.

A.1 Safety Precautions

Please follow the safety precautions outlined in the sections that follow:

A.1.1 General Safety Precautions

Please ensure the following safety precautions are adhered to at all times.

- **Follow the electrostatic precautions** outlined below whenever the EP-308A/EP-308AS is opened.
- **Make sure the power is turned off and the power cord is disconnected** whenever the EP-308A/EP-308AS is being installed, moved or modified.
- **Do not apply voltage levels that exceed the specified voltage range.** Doing so may cause fire and/or an electrical shock.
- **Electric shocks can occur** if the EP-308A/EP-308AS chassis is opened when the EP-308A/EP-308AS is running.
- **Do not drop or insert any objects** into the ventilation openings of the EP-308A/EP-308AS.
- **If considerable amounts of dust, water, or fluids enter the EP-308A/EP-308AS**, turn off the power supply immediately, unplug the power cord, and contact the EP-308A/EP-308AS vendor.
- **DO NOT** do the following:
 - **DO NOT** drop the EP-308A/EP-308AS against a hard surface.
 - **DO NOT** strike or exert excessive force onto the LCD panel.
 - **DO NOT** touch any of the LCD panels with a sharp object
 - **DO NOT** use the EP-308A/EP-308AS in a site where the ambient temperature exceeds the rated temperature

EP-308A/EP-308AS POS

A.1.2 Anti-static Precautions



WARNING:

Failure to take ESD precautions during the installation of the EP-308A/EP-308AS may result in permanent damage to the EP-308A/EP-308AS and sever injury to the user.

Electrostatic discharge (ESD) can cause serious damage to electronic components, including the EP-308A/EP-308AS. Dry climates are especially susceptible to ESD. It is therefore critical that whenever the EP-308A/EP-308AS is opened and any of the electrical components are handled, the following anti-static precautions are strictly adhered to.

- ***Wear an anti-static wristband:*** Wearing a simple anti-static wristband can help to prevent ESD from damaging any electrical component.
- ***Self-grounding:*** Before handling any electrical component, touch any grounded conducting material. During the time the electrical component is handled, frequently touch any conducting materials that are connected to the ground.
- ***Use an anti-static pad:*** When configuring or working with an electrical component, place it on an antic-static pad. This reduces the possibility of ESD damage.
- ***Only handle the edges of the electrical component:*** When handling the electrical component, hold the electrical component by its edges.

A.2 Maintenance and Cleaning Precautions

When maintaining or cleaning the EP-308A/EP-308AS, please follow the guidelines below.

A.2.1 Maintenance and Cleaning

Prior to cleaning any part or component of the EP-308A/EP-308AS, please read the details below.

- Except for the LCD panel, never spray or squirt liquids directly onto any other components. To clean the LCD panel, gently wipe it with a piece of soft dry cloth or a slightly moistened cloth.
- The interior does not require cleaning. Keep fluids away from the interior.
- Be careful not to damage the small, removable components inside.
- Turn off before cleaning.
- Never drop any objects or liquids through the openings.
- Be cautious of any possible allergic reactions to solvents or chemicals used when cleaning.
- Avoid eating, drinking and smoking nearby.

A.2.2 Cleaning Tools

Some components may only be cleaned using a product specifically designed for the purpose. In such case, the product will be explicitly mentioned in the cleaning tips. Below is a list of items to use for cleaning.

- **Cloth** – Although paper towels or tissues can be used, a soft, clean piece of cloth is recommended.
- **Water or rubbing alcohol** – A cloth moistened with water or rubbing alcohol should be used.
- **Using solvents** – The use of solvents is not recommended as they may damage the plastic parts.
- **Vacuum cleaner** – Using a vacuum specifically designed for computers is one of the best methods of cleaning. Dust and dirt can restrict the airflow and cause circuitry to corrode
- **Cotton swabs** - Cotton swaps moistened with rubbing alcohol or water are excellent tools for wiping hard to reach areas.
- **Foam swabs** - Whenever possible, it is best to use lint free swabs such as foam swabs for cleaning.

Appendix

B

BIOS Options

Below is a list of BIOS configuration options in the BIOS chapter.

System Overview	43
System Time [xx:xx:xx]	44
System Date [xx/xx/xx]	44
ATA/IDE Configuration [Compatible]	46
Legacy IDE Channels [SATA Pri, PATA Sec]	46
Configure SATA as [IDE]	47
Auto-Detected Drive Parameters	47
Type [Auto]	48
LBA/Large Mode [Auto]	49
Block (Multi Sector Transfer) [Auto]	49
PIO Mode [Auto]	49
DMA Mode [Auto]	50
S.M.A.R.T [Auto]	51
32Bit Data Transfer [Enabled]	51
Serial Port1 Address [3F8/IRQ4]	52
Serial Port1 Mode [Normal]	52
Serial Port3 Address [3E8]	53
Serial Port3 IRQ [11]	53
Select RS232 or RS422/RS485 [RS/232]	53
Mode Setting [Full On Mode]	54
Temp. Limit of OFF [000]	55
Temp. Limit of Start [020]	55
Start PWM [070]	55
Slope PWM [1 PWM]	55
CPU Fan PWM Control [070]	56
Monitored Values	56
Suspend Mode [S1(POS)]	58
Restore on AC Power Loss [Last State]	58
Power Button Mode [On/Off]	58
Resume on Keyboard/Mouse [Disabled]	59
Resume on Ring [Disabled]	59
Resume on PCI-Express WAKE# [Enabled]	59
Resume On RTC Alarm [Disabled]	60

EP-308A/EP-308AS POS

Remote Access [Disabled].....	61
Serial Port Number [COM1].....	61
Base Address, IRQ [2F8h,3].....	61
Serial Port Mode [115200 8,n,1].....	61
Flow Control [None].....	62
Redirection After BIOS POST [Always]	62
Terminal Type [ANSI].....	62
VT-UTF8 Combo Key Support [Disabled].....	63
Sredir Memory Display Delay [Disabled].....	63
USB Configuration.....	64
USB Devices Enabled.....	64
USB Function [Enabled].....	64
USB 2.0 Controller [Enabled].....	65
Legacy USB Support [Enabled].....	65
USB2.0 Controller Mode [HiSpeed].....	65
USB Mass Storage Reset Delay [20 Sec]	66
Device ##.....	66
Emulation Type [Auto].....	67
IRQ# [Available]	68
DMA Channel# [Available]	69
Reserved Memory Size [Disabled]	69
Quick Boot [Enabled]	71
Quiet Boot [Enabled]	71
AddOn ROM Display Mode [Force BIOS]	71
Bootup Num-Lock [On]	71
Boot From LAN Support [Disabled]	72
Spread Spectrum Mode [Disabled]	72
Change Supervisor Password.....	76
Change User Password.....	76
Memory Hole [Disabled].....	78
Internal Graphics Mode Select [Enable, 8 MB]	78
DVMT Mode Select [DVMT Mode].....	79
DVMT/FIXED Memory [128 MB]	79
Boot Display Device [Auto].....	79
Panel Type	80



Current Jumper Setting.....	80
Cashdraw Control [Enabled].....	81
Audio Controller [Auto].....	81
Save Changes and Exit	82
Discard Changes and Exit.....	82
Discard Changes.....	82
Load Optimal Defaults.....	82
Load Failsafe Defaults.....	82

Appendix

C

Terminology

AC '97	Audio Codec 97 (AC'97) refers to a codec standard developed by Intel® in 1997.
ACPI	Advanced Configuration and Power Interface (ACPI) is an OS-directed configuration, power management, and thermal management interface.
AHCI	Advanced Host Controller Interface (AHCI) is a SATA Host controller register-level interface.
ATA	The Advanced Technology Attachment (ATA) interface connects storage devices including hard disks and CD-ROM drives to a computer.
ARMD	An ATAPI Removable Media Device (ARMD) is any ATAPI device that supports removable media, besides CD and DVD drives.
BIOS	The Basic Input/Output System (BIOS) is firmware that is first run when the computer is turned on and can be configured by the end user
CompactFlash®	CompactFlash® is a solid-state storage device. CompactFlash® devices use flash memory in a standard size enclosure. Type II is thicker than Type I, but a Type II slot can support both types.
COM	COM refers to serial ports. Serial ports offer serial communication to expansion devices. The serial port on a personal computer is usually a male DB-9 connector.
DDR	Double Data Rate refers to a data bus transferring data on both the rising and falling edges of the clock signal.
DMA	Direct Memory Access (DMA) enables some peripheral devices to bypass the system processor and communicate directly with the system memory.
DIMM	Dual Inline Memory Modules are a type of RAM that offer a 64-bit data bus and have separate electrical contacts on each side of the module.
DIO	The digital inputs and digital outputs are general control signals that control the on/off circuit of external devices or TTL devices. Data can be read or written to the selected address to enable the DIO functions.
EHCI	The Enhanced Host Controller Interface (EHCI) specification is a register-level interface description for USB 2.0 Host Controllers.

EP-308A/EP-308AS POS

EIDE	Enhanced IDE (EIDE) is a newer IDE interface standard that has data transfer rates between 4.0 MBps and 16.6 MBps.
EIST	Enhanced Intel® SpeedStep Technology (EIST) allows users to modify the power consumption levels and processor performance through application software. The application software changes the bus-to-core frequency ratio and the processor core voltage.
FSB	The Front Side Bus (FSB) is the bi-directional communication channel between the processor and the Northbridge chipset.
GbE	Gigabit Ethernet (GbE) is an Ethernet version that transfers data at 1.0 Gbps and complies with the IEEE 802.3-2005 standard.
GPIO	General purpose input
HDD	Hard disk drive (HDD) is a type of magnetic, non-volatile computer storage device that stores digitally encoded data.
ICH	The Input/Output Control Hub (ICH) is an Intel® Southbridge chipset.
IrDA	Infrared Data Association (IrDA) specify infrared data transmission protocols used to enable electronic devices to wirelessly communicate with each other.
L1 Cache	The Level 1 Cache (L1 Cache) is a small memory cache built into the system processor.
L2 Cache	The Level 2 Cache (L2 Cache) is an external processor memory cache.
LCD	Liquid crystal display (LCD) is a flat, low-power display device that consists of two polarizing plates with a liquid crystal panel in between.
LVDS	Low-voltage differential signaling (LVDS) is a dual-wire, high-speed differential electrical signaling system commonly used to connect LCD displays to a computer.
RAM	Random Access Memory (RAM) is volatile memory that loses data when power is lost. RAM has very fast data transfer rates compared to other storage like hard drives.

SATA	Serial ATA (SATA) is a serial communications bus designed for data transfers between storage devices and the computer chipsets. The SATA bus has transfer speeds up to 1.5 Gbps and the SATA II bus has data transfer speeds of up to 3.0 Gbps.
S.M.A.R.T	Self Monitoring Analysis and Reporting Technology (S.M.A.R.T) refers to automatic status checking technology implemented on hard disk drives.
UART	Universal Asynchronous Receiver-transmitter (UART) is responsible for asynchronous communications on the system and manages the system's serial communication (COM) ports.
UHCI	The Universal Host Controller Interface (UHCI) specification is a register-level interface description for USB 1.1 Host Controllers.
USB	The Universal Serial Bus (USB) is an external bus standard for interfacing devices. USB 1.1 supports 12Mbps data transfer rates and USB 2.0 supports 480Mbps data transfer rates.
VGA	The Video Graphics Array (VGA) is a graphics display system developed by IBM.

Appendix

D

Watchdog Timer

NOTE:

The following discussion applies to DOS environment. IEI support is contacted or the IEI website visited for specific drivers for more sophisticated operating systems, e.g., Windows and Linux.

The Watchdog Timer is provided to ensure that standalone systems can always recover from catastrophic conditions that cause the CPU to crash. This condition may have occurred by external EMIs or a software bug. When the CPU stops working correctly, Watchdog Timer either performs a hardware reset (cold boot) or a Non-Maskable Interrupt (NMI) to bring the system back to a known state.

A BIOS function call (INT 15H) is used to control the Watchdog Timer.

INT 15H:

AH – 6FH Sub-function:	
AL – 2:	Sets the Watchdog Timer's period.
BL:	Time-out value (Its unit-second is dependent on the item "Watchdog Timer unit select" in CMOS setup).

Table D-1: AH-6FH Sub-function

Call sub-function 2 to set the time-out period of Watchdog Timer first. If the time-out value is not zero, the Watchdog Timer starts counting down. When the timer value reaches zero, the system resets. To ensure that this reset condition does not occur, calling sub-function 2 must periodically refresh the Watchdog Timer. However, the watchdog timer is disabled if the time-out value is set to zero.

A tolerance of at least 10% must be maintained to avoid unknown routines within the operating system (DOS), such as disk I/O that can be very time-consuming.



NOTE:

When exiting a program it is necessary to disable the Watchdog Timer, otherwise the system resets.

Example program:

; INITIAL TIMER PERIOD COUNTER

;

W_LOOP:

```

MOV    AX, 6F02H    ;setting the time-out value
MOV    BL, 30       ;time-out value is 48 seconds
INT    15H

```

;

; ADD THE APPLICATION PROGRAM HERE

;

```

CMP    EXIT_AP, 1   ;is the application over?
JNE    W_LOOP       ;No, restart the application

```

```

MOV    AX, 6F02H    ;disable Watchdog Timer
MOV    BL, 0        ;
INT    15H

```

;

; EXIT ;

Appendix

E

Hazardous Materials Disclosure

E.1 Hazardous Materials Disclosure Table for IPB Products Certified as RoHS Compliant Under 2002/95/EC Without Mercury

The details provided in this appendix are to ensure that the product is compliant with the Peoples Republic of China (China) RoHS standards. The table below acknowledges the presences of small quantities of certain materials in the product, and is applicable to China RoHS only.

A label will be placed on each product to indicate the estimated “Environmentally Friendly Use Period” (EFUP). This is an estimate of the number of years that these substances would “not leak out or undergo abrupt change.” This product may contain replaceable sub-assemblies/components which have a shorter EFUP such as batteries and lamps. These components will be separately marked.

Please refer to the table on the next page.

Part Name	Toxic or Hazardous Substances and Elements					
	Lead (Pb)	Mercury (Hg)	Cadmium (Cd)	Hexavalent Chromium (CR(VI))	Polybrominated Biphenyls (PBB)	Polybrominated Diphenyl Ethers (PBDE)
Housing	X	O	O	O	O	X
Display	X	O	O	O	O	X
Printed Circuit Board	X	O	O	O	O	X
Metal Fasteners	X	O	O	O	O	O
Cable Assembly	X	O	O	O	O	X
Fan Assembly	X	O	O	O	O	X
Power Supply Assemblies	X	O	O	O	O	X
Battery	O	O	O	O	O	O
<p>O: This toxic or hazardous substance is contained in all of the homogeneous materials for the part is below the limit requirement in SJ/T11363-2006</p> <p>X: This toxic or hazardous substance is contained in at least one of the homogeneous materials for this part is above the limit requirement in SJ/T11363-2006</p>						

EP-308A/EP-308AS POS

此附件旨在确保本产品符合中国 RoHS 标准。以下表格标示此产品中某有毒物质的含量符合中国 RoHS 标准规定的限量要求。

本产品上会附有“环境友好使用期限”的标签，此期限是估算这些物质“不会有泄漏或突变”的年限。本产品可能包含有较短的环境友好使用期限的可替换元件，像是电池或灯管，这些元件将会单独标示出来。

部件名称	有毒有害物质或元素					
	铅 (Pb)	汞 (Hg)	镉 (Cd)	六价铬 (CR(VI))	多溴联苯 (PBB)	多溴二苯醚 (PBDE)
壳体	X	O	O	O	O	X
显示	X	O	O	O	O	X
印刷电路板	X	O	O	O	O	X
金属螺帽	X	O	O	O	O	O
电缆组装	X	O	O	O	O	X
风扇组装	X	O	O	O	O	X
电力供应组装	X	O	O	O	O	X
电池	O	O	O	O	O	O

O: 表示该有毒有害物质在该部件所有物质材料中的含量均在 SJ/T11363-2006 标准规定的限量要求以下。
X: 表示该有毒有害物质至少在该部件的某一均质材料中的含量超出 SJ/T11363-2006 标准规定的限量要求。