

Operating Guide

2000XL Series Digital Dispensers

2000XL • 2000XL-PR5-15 • 2000XL-CA

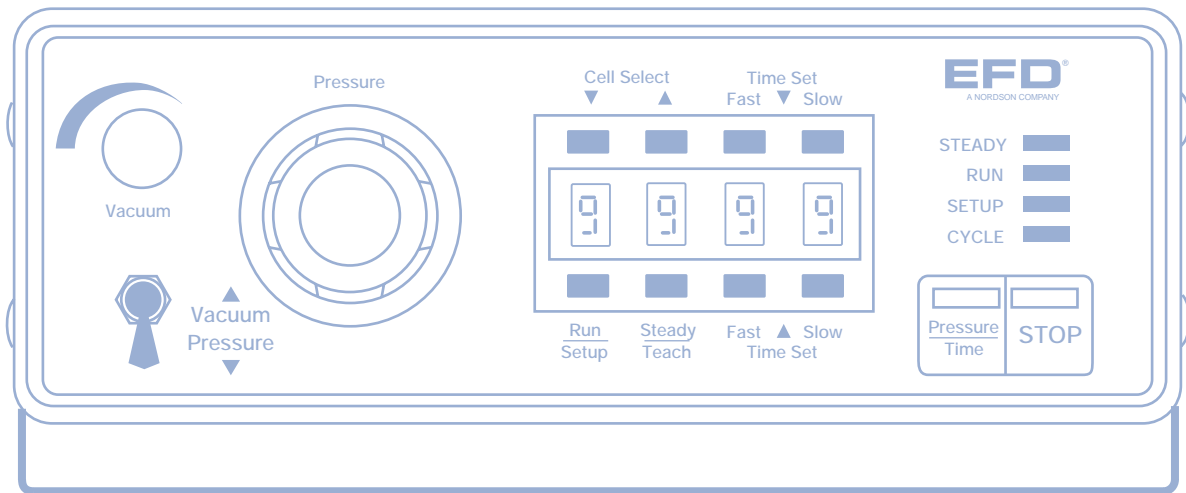

Introduction

The 2000XL Series dispensers provide years of trouble-free, productive service. This Operating Guide will help you maximize the usefulness of your new dispenser.

Please spend a few minutes to become familiar with the controls and features of your new dispenser. Follow our recommended testing procedures. Review the helpful information we have included based on over 30 years of industrial dispensing experience.

Most questions you will have are answered in this guide. However, if you need assistance, please do not hesitate to contact EFD or your authorized EFD distributor.



In the US, call 800-556-3484.

In Mexico, call 001-800-556-3484.

In the UK, ring free 0800 585733.

The EFD Pledge

We pledge that you will be completely satisfied with our products. We endeavor to ensure that every EFD product is produced to our no-compromise quality standards.

If you feel that you are not receiving all the support you require, or if you have any questions or comments, I invite you to write or call me personally.

Our goal is to build not only the finest equipment and components, but also to build long-term customer relationships founded on superb quality, service, value and trust.

Randall Richardson, President

Contents

Getting Started	4
Specifications	
First Steps	5
Unpacking the dispenser & Activating your Ten Year No-fault Warranty	
Features and Controls	6-7
Indicator Lamps	7
Setup	8-10
Setup procedures	8-9
Diagram	10
Final checklist	10
Testing the 2000XL	11-12
Programming deposit size	12
Operational Features	13
ULTRA Dispensing System	14-15
How to Use the Vacuum Control	16-17
Loading the Barrel Reservoirs	18-19
Memory Function	20-21
Input and Output Connection Instructions	22
Schematic and Replacement Parts List	23
Troubleshooting	24
Suggestions and Reminders	25
Reordering Components	26
Ten Year No-fault Warranty	27

This manual is for the express and sole use of EFD dispenser purchasers and users, and no portion of this manual may be reproduced in any form.

EFD, ULTRA System, LV Barrier and SmoothFlow are trademarks of EFD Inc. ©2002 EFD Inc.

Meets applicable CSA and CE requirements.

Getting Started

The 2000XL Series automatic fluid dispensers are designed to provide complete process control using advanced microprocessor circuitry. All microprocessor functions are accessed by push button.

Microprocessor features include:

- Push-button time setting input or one-touch time programming.
- Floating decimal, providing dispense time ranges of 0.001 to 9.999 and 00.01 to 99.99 seconds.
- Backlit LCD displays time settings, dispensing pressure and vacuum pressure.
- Dispensing pressure display is programmable for either psi or bar scale.
- Memory with storage for up to eight separate time settings.

Intelligent technology makes the 2000XL Series easy to set up and use. With one-touch setup, just press the pedal to determine the proper amount. The microprocessor remembers the time and repeats this amount with each cycle until you are ready to change it.

From microdeposits to volumetric filling, the 2000XL provides the ultimate in control and versatility for time/pressure-based fluid dispensing.

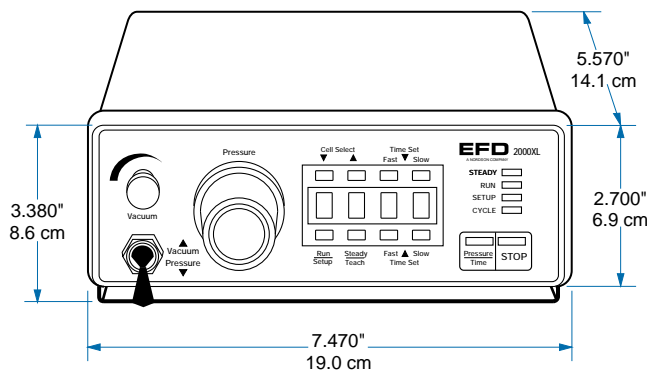

Specifications

Cabinet size: 7.470 x 5.570 x 2.700" (19.0 x 14.1 x 6.9 cm)
Weight: 3 lb 3 oz 1.44 kg

Input voltage: Selectable 100/120/220 VAC
50/60 Hz 10/9 VA

End-of-cycle feedback circuits: 5 to 24 VDC N.C. solid-state switch
250mA maximum (details page 23)

Initiate circuit: Foot pedal or 5 to 24 VDC signal

Air consumption: Approximately 1.5 SCFM at 400 cycles per minute

Cycle rate: Exceeds 600 per minute

Time range: Programmable 0.001 to 9.999, or 00.01 to 99.99 seconds

2000XL

air input: 80 to 100 psi (5.5 bar to 6.9 bar)
air output: 0 to 100 psi (0 to 6.9 bar)

2000XL-PR5

air input: 10 to 50 psi (0.7 bar to 3.4 bar)
air output: 0 to 5 psi (0 to .34 bar)

2000XL-CA

air input: 80 to 100 psi (5.5 bar to 6.9 bar)
air output: 0 to 15 psi (0 to 1.0 bar)

Note: Specifications and technical details are subject to engineering changes without prior notification.

First Steps

First: Unpack and use the checklist enclosed with the Dispenser Kit to identify all items. If there is any discrepancy, please call us immediately.

Second: Power and compressed plant air should be available where the dispenser is to be set up. Input air should be set between 80 and 100 psi (5.5 and 6.9 bar). For model 2000XL-PR5, input air should be set between 10 and 50 psi (0.7 and 3.4 bar). If you are not using an EFD five-micron filter regulator #2000F755, **be certain your plant air is properly filtered and dry and a regulated, constant air pressure is supplied to the dispenser.**

Note: Model 2000XL-CA is supplied with an EFD five-micron filter regulator with coalescing filter (#2000F756).

Bottled nitrogen can be used.

Warning: If high pressure bottled air or nitrogen is used, a high pressure regulator must be installed on the bottle and set at 100 psi maximum. The 2000F755 filter regulator is not required.

Check the voltage label to be certain it is set to the available power.

Third: Now is a good time to ACTIVATE your extended Ten Year No-fault Warranty. Please fill in and return the postage paid Warranty card. Or if you prefer, call the appropriate toll-free number listed below, provide the serial number of your dispenser and respond to a few short questions.



In the US, call 800-556-3484.

In Mexico, call 001-800-556-3484.

In the UK, ring free 0800 585733.

Features and Controls

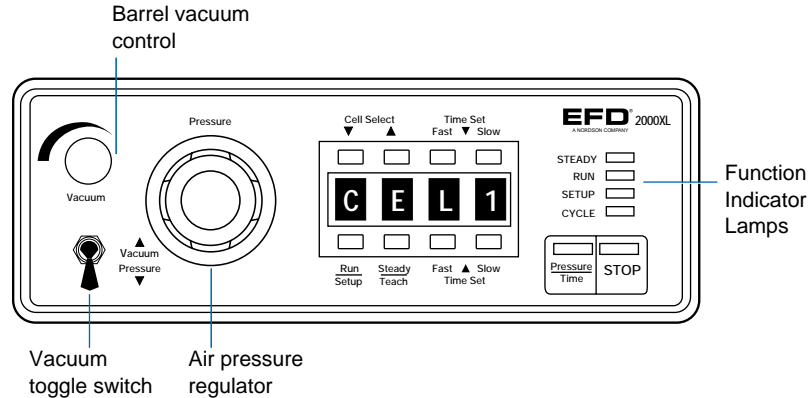

Digital Time, Air Pressure and Vacuum Pressure LCD Display

- Programmable floating decimal provides time range readout from 0.001 to 99.99 seconds.
- Air pressure readout can be programmed in either psi or bar.
- Vacuum pressure readout is displayed by holding the vacuum toggle switch in the "up" position.

Memory

Can store up to eight Time settings. (See page 20.)

Run/Setup

1. The **RUN** mode allows access to all eight cells. Cell numbers are displayed as CEL1, CEL2....CEL8. Changing the cell number will change the time setting corresponding to that cell. The **SETUP** mode provides access to selected cell **TEACH** and **TIME SET** functions. Only in the **SETUP** mode can cell time values be viewed, cleared, or changed.
2. In the **RUN** mode, the functions are inoperative.

Steady/Teach

In **SETUP** mode, pressing **STEADY/TEACH** will clear the currently displayed cell setting, reset the cell display to blinking "0000", and place the dispenser

in a **TEACH** mode (refer to page 12 for **TEACH** procedures).

In **RUN** mode, pressing **STEADY/TEACH** will override the timer and dispense for as long as the foot pedal is pressed. The dispenser display will read "----" in the **STEADY** mode.

Time Set ▼ (down) ▲ (up)

In **SETUP** mode, use the **TIME SET** buttons to change time settings. Left buttons scroll digits quickly; right buttons scroll digits slowly.

Pressure/Time

Press to change display values from **TIME** to **PRESSURE** or **PRESSURE** back to **TIME**.

In **SETUP** mode, pressure readings may be changed from **PSI** to **BAR** and **BAR** to **PSI** by pressing and holding the **PRESSURE/TIME** button for four seconds.

STOP

This button stops the dispenser immediately.

Barrel Vacuum Control

Refer to page 16 for operation.

Air Pressure Regulator

Refer to page 11 for operating instructions.

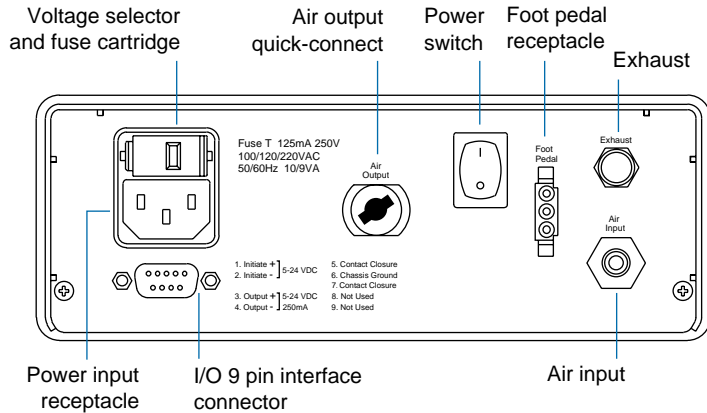

Power Input Receptacle with Voltage Selector and Fuse Cartridge

Three input voltages can be used: 100 VAC, 120 VAC and 220 VAC. To change input voltage, remove fuse cartridge and position the selected voltage marked on the cartridge so that it shows through the window. (Details on page 8.)

Input/Output 9 Pin Interface Connector

The input/output features are used when the dispenser is interfaced with external control circuits.

- An End-of-Cycle signal, in the form of a solid-state switch, closes upon completion of the dispense cycle. Maximum load is 250mA from 5 to 24 VDC.
- The 2000XL can be initiated using a 5 to 24 VDC signal.
- Contact Closure.

(For more details, refer to page 22.)

Indicator Lamps

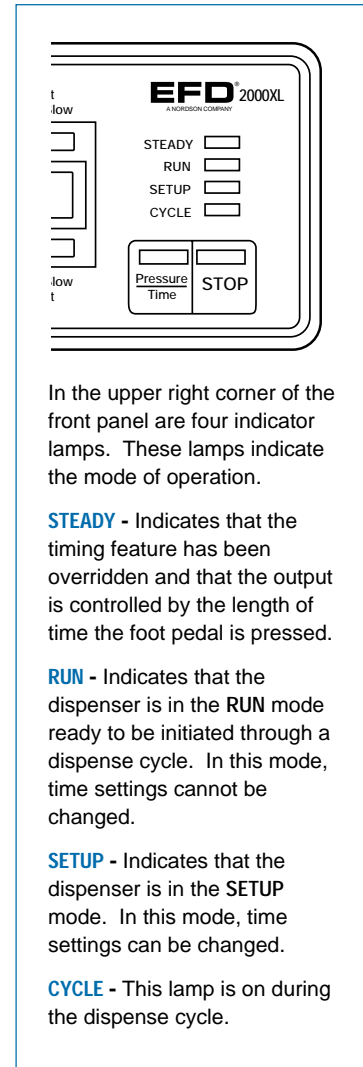

In the upper right corner of the front panel are four indicator lamps. These lamps indicate the mode of operation.

STEADY - Indicates that the timing feature has been overridden and that the output is controlled by the length of time the foot pedal is pressed.

RUN - Indicates that the dispenser is in the **RUN** mode ready to be initiated through a dispense cycle. In this mode, time settings cannot be changed.

SETUP - Indicates that the dispenser is in the **SETUP** mode. In this mode, time settings can be changed.

CYCLE - This lamp is on during the dispense cycle.

Setup

Power switch should be off.

1 Mounting

Included is a universal mounting bracket. Mounting hardware is installed into the four 10-32 mounting holes on the sides of the cabinet. The bracket can be mounted either over or under the cabinet and will allow the dispenser to pivot up or down 30° from a horizontal position. The bracket may be permanently mounted, or attach the rubber feet included and use the bracket as a bench-top tilt stand. Four rubber feet on the console are provided if the bracket is not used.

2 Input power

Check the input power cord receptacle. To change voltage, remove the voltage selector from the cartridge, rotate it and position the correct voltage to show through the cartridge window. Replace the cartridge into the power cord receptacle and insure that both sides snap securely into position.

Install the power cord.

3 Initiate connection

The 2000XL is normally operated using the foot pedal supplied. Plug the foot pedal into the connector located on the rear panel. An alternate method is to apply a 5 to 24 VDC pulse to terminals 1 and 2.

4 Air input connection

A 6 ft. air input hose kit is supplied. Connect the input hose to filtered, dry plant air. For models 2000XL and 2000XL-CA, set plant air supply within 80 to 100 psi (5.5 to 6.9 bar). For model 2000XL-PR5, input air should be set within 10 to 50 psi (0.7 to 3.4 bar).

Attach the air input hose coupling to the dispenser. Pull back metal ring to attach to dispenser.

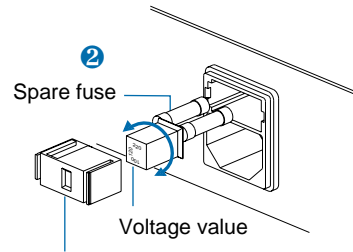
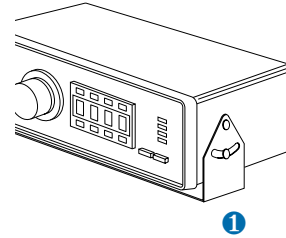

Cartridge window
Note: Check voltage indicated

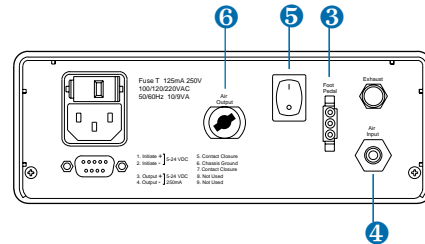

Note: If filtered, dry air is not available, order an EFD five-micron filter regulator #2000F755. (2000XL-CA units are supplied with a five-micron coalescing filter regulator.)

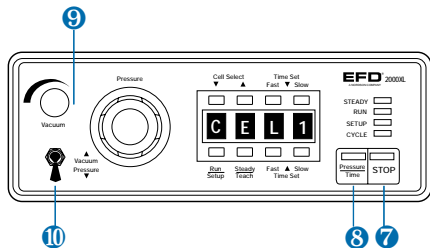

5 Power on/off

Press the Power Switch located on the rear panel to the "ON" position. The dispenser will power up in the RUN, STEADY, or PRESSURE mode and indicate which cell was selected last. (Dispenser is shipped with *CEL1* selected in RUN mode).

6 Air output

Push in and twist lock the 10cc adapter assembly (part # 1000Y5150). The number 5150 is molded on the side of the yellow head.

7 Setting the decimal

The dispenser is shipped with the decimal set at hundredths of a second (00.00). The decimal can be moved to show thousandths of a second (0.000) as follows:

Press RUN/SETUP to place the dispenser in SETUP mode.

To move the decimal, press and hold the STOP button. After approximately 4.0 seconds, the decimal will move to the thousandths position. To return to the hundredths position, press and hold the STOP button again.

Note: Changing the decimal place changes the current time setting by a factor of 10. For example, 5.35 seconds becomes 53.50; 15.00 seconds becomes 1.50.

8 Setting the pressure readout

The dispenser is shipped with pressure display programmed in psi.

Note: On models with 5 psi and 15 psi regulators, the pressure is adjustable in 0.1 psi increments.

If bar is desired, change as follows:

Press RUN/SETUP and place the dispenser into the SETUP mode. Press and hold the PRESSURE/TIME button for 4.0 seconds. The display will change from psi to bar. To change back to psi, press and hold PRESSURE/TIME for 4.0 seconds.

9 Vacuum control

Vacuum is turned off (clockwise) during testing procedures. (Refer to page 16 for operation.)

10 Vacuum toggle switch

To read vacuum pressure, hold toggle switch in the "up" position. Readout will appear on the digital display pad, then return to air pressure readout when toggle is released.

Continue to page 11 for test procedures.

Note: Plant air, 125 psi maximum to regulator. Output from regulator should be a minimum of 80 psi, maximum 100 psi. For model 2000XL-PR5, output from regulator should be set at 30 psi.

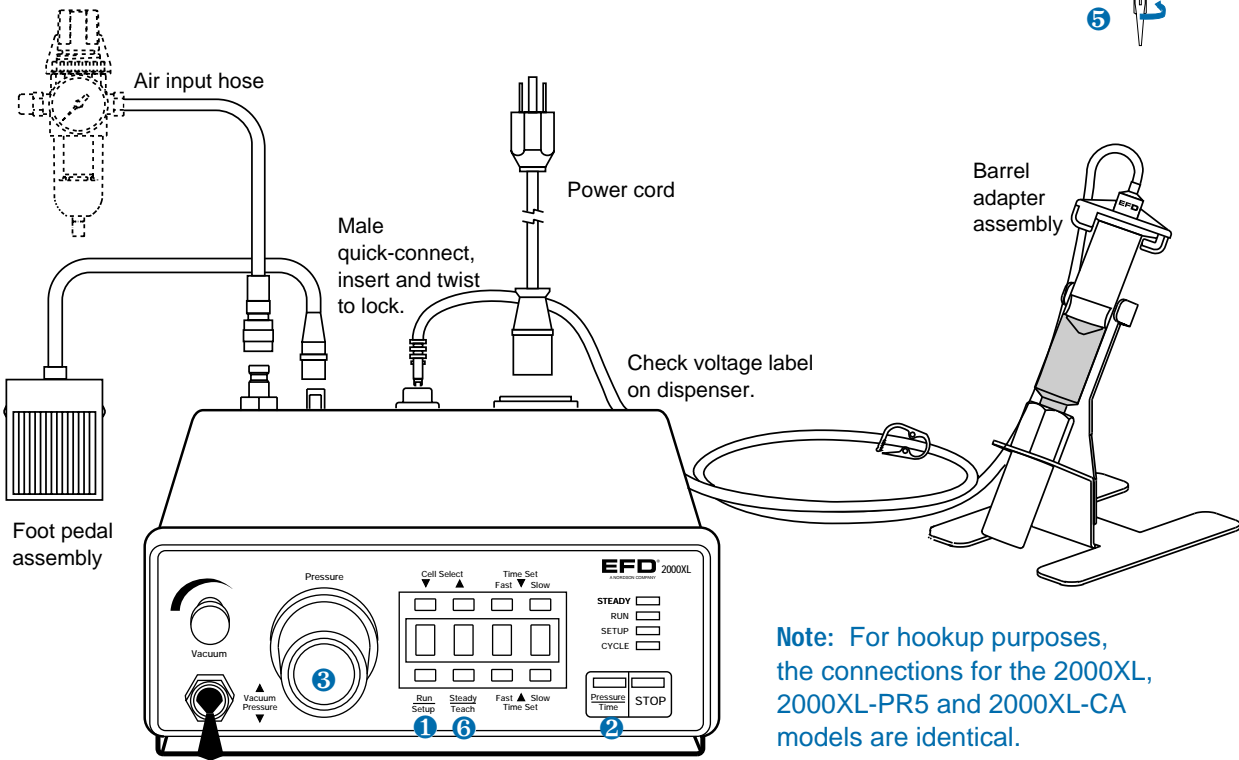
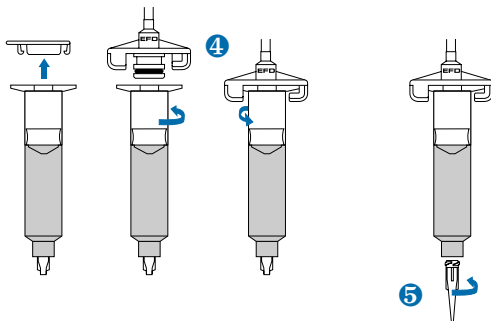

Note: For hookup purposes, the connections for the 2000XL, 2000XL-PR5 and 2000XL-CA models are identical.

Setup for Testing

Deposit size is controlled by **TIME**, **PRESSURE** and **TIP SIZE**.

Please follow these instructions in order to test each function. Use the convenient Dot Test sheet included in your Test Kit.

Setup for Testing

Press **RUN/SETUP 1** to set the dispenser into the **RUN** mode (**RUN** indicator light on).

Press **PRESSURE/TIME 2** and set display to pressure.

Pull out air pressure regulator knob **3** until it "clicks" into the unlocked position. Turn clockwise to adjust the pressure to 20 psi (1.4 bar).

Note: Dispensers with 5 psi or 15 psi gauges should be tested with the clear test fluid, using a lavender 30 gage tip and air pressure set at 5 psi. Refer to "How to Use the Vacuum Control" on page 16.

Always set the pressure desired by turning the air regulator knob clockwise. To reduce the pressure, turn the knob counterclockwise until the air gauge reads a lower pressure than desired. Then increase and stop at desired pressure. Push knob in to lock.

Dispensers with air pressure gauges higher than 15 psi are tested using the nontoxic blue fluid supplied in the Dot Test kit. This fluid is representative of thick, non-leveling fluids such as sealants, pastes and greases and is used to demonstrate the different control settings.

Attach the barrel containing the test material to the adapter assembly **4** as shown.

Remove the orange tip cap from the end of the dispensing barrel and attach the green 18 gage tapered tip **5** found in the Dot Test Kit. Place the barrel in the barrel stand.

Press **STEADY/ TEACH 6** to place the 2000XL into **STEADY** mode. (**STEADY** indicator light on.)

Rest the dispensing tip on the Dot Test sheet. Press and hold the foot pedal until the tip fills with test material.

Go into **TIME** mode by pressing **STEADY/ TEACH 6** again (**STEADY** indicator light goes out) and time is displayed.

Press **RUN/SETUP 1** to place the 2000XL into the **SETUP** mode (**SETUP** indicator light on). Press **STEADY/ TEACH 6** to zero the display.

Continue to page 12 for tests which will demonstrate the ease at which deposit sizes can be established using the foot pedal or **TIME SET** feature.

Testing (continued)

Program (TEACH) the Deposit Time with the Foot Pedal

When a specific time value is not known, as when first dispensing an amount, the time may be programmed using the foot pedal.

Press **RUN/SETUP** to set the dispenser into **RUN** mode (**RUN** indicator light on). Select the memory cell you wish to program, e.g. **CEL1**, **CEL2**....**CEL8**.

Return the dispenser to **SETUP** mode and clear cell memory by pressing **STEADY/TEACH**. The dispenser displays a blinking "0000" to indicate that it is in **TEACH** mode and ready for programming.

Holding the barrel as shown, rest the tip on the Dot Test sheet. Press the foot pedal for about one second. Notice that the display now shows the length of time the foot pedal was pressed.

Keeping the tip in the same place, press the pedal again for about two seconds and add to the first deposit. Now the display shows the total time for both deposits.

You can build up to the desired amount by simply pressing the foot pedal repetitively until the deposit is the proper size. If the deposit becomes too large, press **STEADY/TEACH** and start again. Press **RUN/SETUP** to save the setting and return to the **RUN** mode.

Program the Deposit Time with a Specified Time Setting

Set the dispense time when the desired time **SET** buttons below the display to scroll up and **TIME SET** buttons above the display to scroll down. The button on the right scrolls slowly for single digit setting; the one to the left scrolls fast.

Press **STEADY/TEACH**, then set the time to 1.15 seconds using the **TIME SET** buttons. Press **RUN/SETUP** to return to the **RUN** mode. Press the pedal and make a 1.15 second deposit.

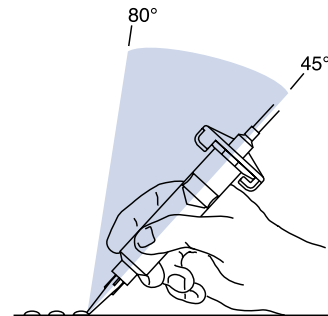

Correct angle for consistent deposits.

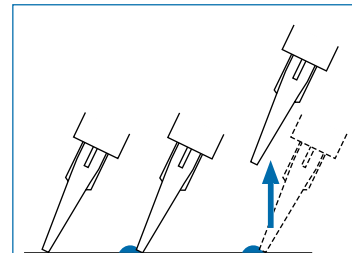

Remember - always bring the tip in contact with the work surface at the illustrated angle. After the tip is in position, press the foot pedal. Release pedal and remove tip by lifting straight up.

Note: The pedal needs only to be pressed momentarily. The complete time cycle will run once the dispenser is initiated.

Press **RUN/SETUP** and toggle back to the **SETUP** mode. Press the **TIME SET** buttons and change the time to 2.30 seconds. Go back to **RUN**, press the foot pedal, and the dispenser will make a deposit approximately twice the size of the first one.

Pressure—changes deposit size.

The dispenser should be in the **RUN** mode, the **TIME** setting should be 2.30 seconds and the dispensing pressure should be 20 psi (1.4 bar).

Increasing the pressure will result in larger deposits, decreasing the pressure will result in smaller deposits. Try this now and observe the results.

Tip Size—changes deposit size.

Tip size also affects deposit size. Without changing the **TIME** or **PRESSURE** setting, try different tips and observe the results.

Don't Forget!

- ✓ Changes to the time settings can be made only when the mode of operation is **SETUP**.
- ✓ **RUN** mode locks out **TIME SET** and **TEACH** control buttons. Use this to protect the setup from inadvertent changes.
- ✓ Pressing **STEADY/TEACH** in **SETUP** mode will clear all time settings within cell.
- ✓ **STOP** immediately terminates the current dispense cycle.
- ✓ Use only dry, clean, filtered air.



If you have any questions at this point, please call us now.

In the US, call 800-556-3484

(Between 8:30 am and 6:00 pm eastern time.)

In Mexico, call 001-800-556-3484.

In the UK, ring free 0800 585733.



Advanced Dispensing System

If you dispense thick fluids, several problems may occur. First, the repetitive air cycles can bore tunnels through non-leveling fluids, causing spitting and inconsistent deposits. Second, thick fluids contain trapped air that leads to drooling and oozing.

These problems are eliminated by using the SmoothFlow™ piston. That's because the white pistons prevent tunneling by providing a barrier to the pulsed-air cycles, and prevent oozing by responding to the pressure of trapped air with a slight suck-back movement after the dispense cycle.

The white piston is used for most fluids.

However, if you are applying RTV silicone and find that the piston bounces and causes stringing, switch to the orange, flat wall piston.

The SmoothFlow™ pistons make barrel filling easier, too. As you load the fluid in, air is trapped in the bottom and throughout the fluid. Simply insert a SmoothFlow™ piston and gently press down on the fluid as far as possible. This action forces out most of the air and results in consistent deposits.

For Thick Fluids

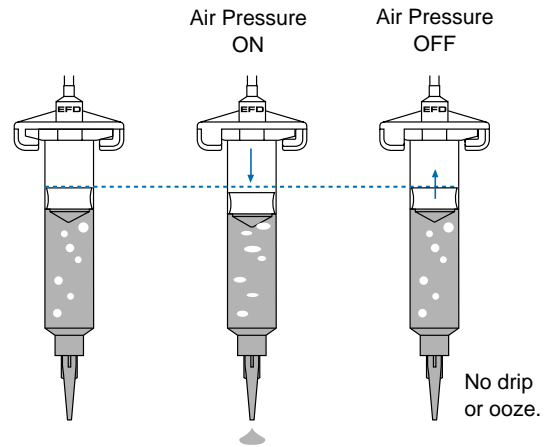

If you use low to medium viscosity fluids, the white SmoothFlow™ piston has several advantages.

First, vacuum adjustment is much less sensitive. Second, the piston prevents fumes from the fluid being exhausted into the work environment. Third, the piston prevents fluid backflow into the dispenser if the barrel is inadvertently turned upside down. Fourth, using the piston makes it easy and safe to change tips without dripping.

Note: If you use watery-thin fluids such as solvents, cyanoacrylates and anaerobics, specify the ULTRA System™ with the blue LV Barrier™. Available in 3cc and 10cc sizes.

For Thinner Fluids

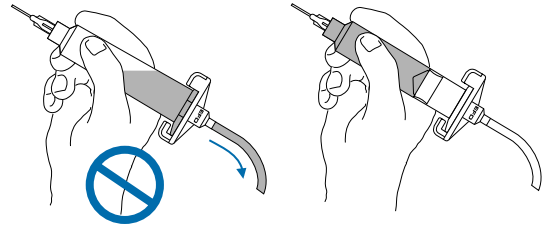

SmoothFlow™ piston prevents fluid backflow.

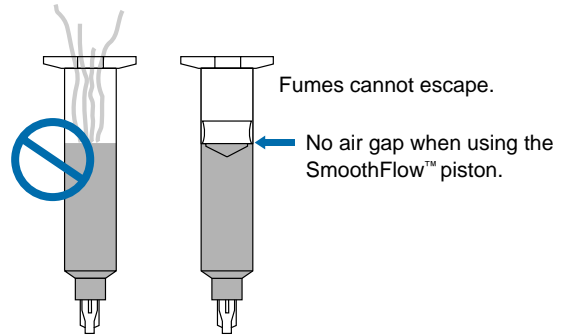

For Cyanoacrylates or Watery-thin Fluids

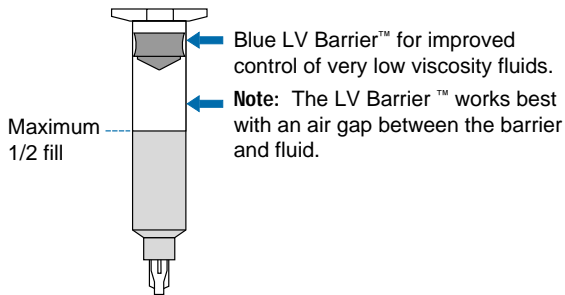

Note: If you choose not to use the piston, please refer to page 17 for instructions.

How to use the Vacuum Control

The vacuum control allows low viscosity fluids, even water, to be consistently dispensed without dripping between cycles. The vacuum exerts a negative pressure on the liquid in the barrel and prevents dripping.

For these tests, you will use the test barrel with the clear fluid.

1. While holding the barrel upright in one hand, remove the orange end cap and insert the blue LV Barrier™. Allow an air gap as shown.
2. Attach the barrel to the 10cc adapter. Snap the safety clip tightly closed to prevent any dripping or bubbling. Remove the tip cap and attach the 30 gage (lavender) tip.
3. Set air pressure at 5 psi.
4. Press **RUN/SETUP** to go into **SETUP** mode and set **TIME** for 00.05 seconds. Press **RUN/SETUP** to return to **RUN** mode.
5. Press **STEADY/TEACH** (**STEADY** indicator light on).
6. With the barrel pointing downward over a container, unsnap the safety clip and press the foot pedal to fill the tip.
7. If a drop begins to form at the end of the tip, slowly turn the vacuum control knob counterclockwise to stop the drop from growing. Wipe the tip and adjust vacuum as necessary.
8. To read vacuum pressure, press **PRESSURE/TIME** so that system air pressure is displayed. Hold toggle switch in the "up" position to view vacuum pressure. Release toggle to return display to system air pressure readout.
9. Press **STEADY/TEACH** (**STEADY** indicator light off).
10. Take the barrel and place the tip on the test sheet. Press the foot pedal and release. Check the dot size. Increase or decrease by adjusting pressure or time.

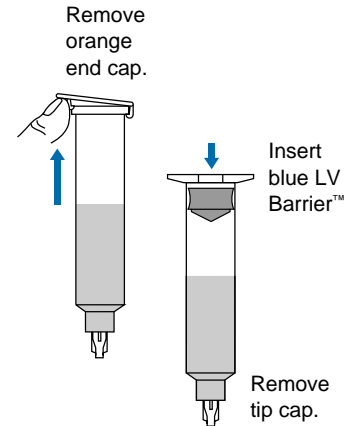

Three things to remember

If you do not use the piston when dispensing thin fluids:

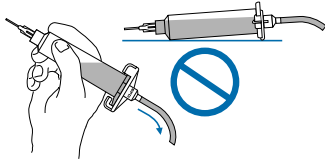

Do not tip the barrel upside down or lay flat. This will cause the liquid to run into the dispenser.

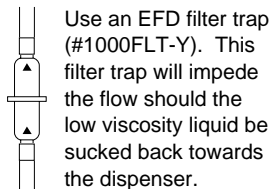
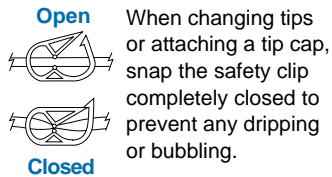

If you choose **not**

+to use the piston, please follow these instructions carefully:

1. While holding the barrel upright in one hand, twist on an orange tip cap. Using the small funnel, fill about 2/3 full with your fluid.
2. Open the safety clip and attach the barrel to the 10cc adapter.
3. Close the safety clip as tight as possible.
4. Slightly increase vacuum by turning vacuum control knob counterclockwise.
5. Then, without tipping the barrel upside down, remove the tip cap and attach the 30 gage (lavender) tip.
6. Open the safety clip. Your material may begin to bubble. Reduce vacuum by turning vacuum control knob clockwise.
7. If a drop begins to form at the end of the tip, slowly turn the vacuum control knob counterclockwise to stop the drop from growing. Wipe the tip and adjust vacuum as necessary.

Now the fluid is in proper balance. It does not bubble or drip.

Repeat tests as before, keeping the air pressure low and adjusting the time for different deposit sizes.



In the US, call 800-556-3484.

In Mexico, call 001-800-556-3484.

In the UK, ring free 0800 585733.

Loading the Barrel Reservoirs

Caution: Do not completely fill barrels. The optimum fill is a maximum 2/3 of the barrel capacity and 1/2 of the barrel capacity when using the LV Barrier™.

If the fluid you are dispensing is pourable, take the barrel, twist on a tip cap and pour your fluid in. If appropriate, insert the SmoothFlow™ piston (see page 14). Carefully press the piston down until it contacts the fluid. The barrel is now ready for use.

If you are dispensing watery solvents, cyanoacrylates or anaerobics, use the LV Barrier™. Place barrier in the top of the barrel reservoir. Allow air between barrier and fluid. Do not contact the barrier to the fluid.

If your fluid is thick or non-leveling, you can spoon it into the barrel with a spatula. Or, if the fluid comes packed in a 1/10 gallon cartridge, try loading the barrel with a caulking gun. Then, press in the SmoothFlow™ piston to move the fluid to the bottom of the barrel and to remove trapped air.

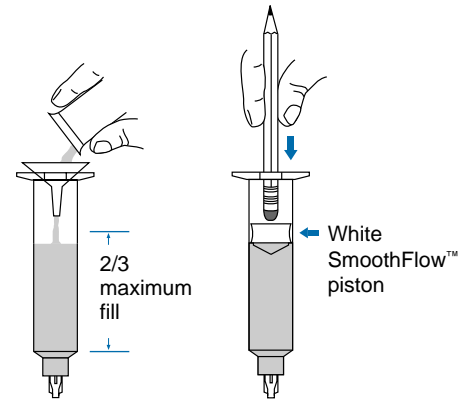

Fill procedure for pourable fluids

Fill procedure for thick fluids (shown: caulking gun)

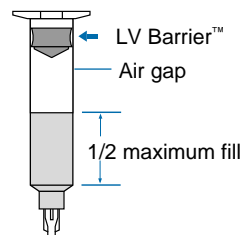
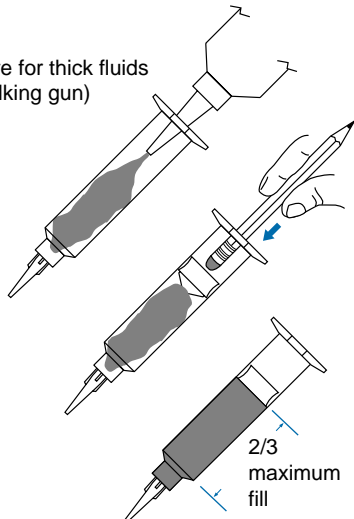

Fill procedure for cyanoacrylates or watery-thin fluids

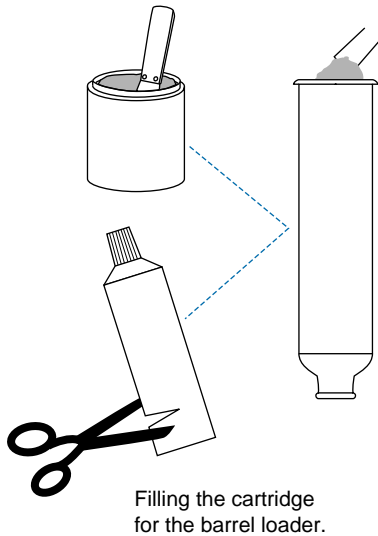

EFD offers productive alternatives to traditional barrel loading methods. Here are a few suggestions that can help keep your work area clean, save time and reduce the chance of entrapped air in the fluid.

1. You could use the EFD #920BL barrel loader. Pack the fluid into the 12 ounce cartridge as shown. Then place the prefilled cartridge into the barrel loader. Using air pressure, the barrel loader fills the barrel (with piston) from the bottom up.

If the fluid comes packed in a 1/10 gallon (300 ml.) caulking type cartridge, use the EFD #940BL barrel loader.

2. If you receive frozen epoxies or other fluids in medical type syringes with a manual plunger, request our luer-to-luer fitting #2160 to transfer the material.

Please call an EFD Fluid Application Specialist for additional assistance.

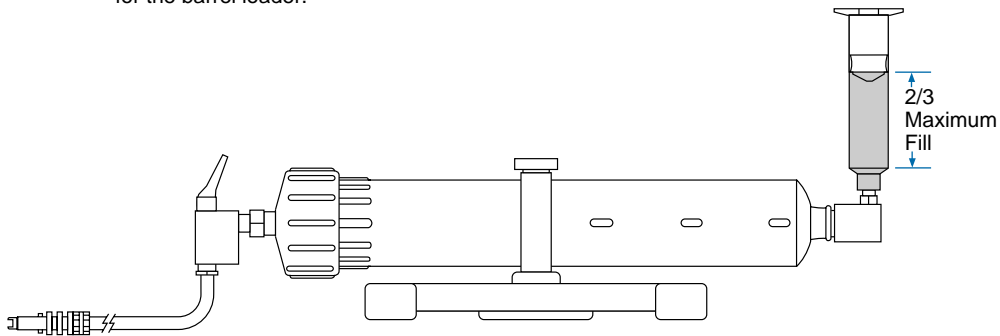

EFD #920BL Barrel Loader
(Specify #940BL for prefilled 1/10 gallon caulking tubes)

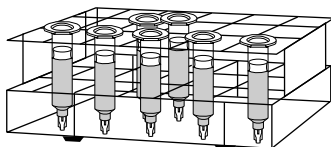

Barrel Rack
#905BR for 3cc and 5cc barrels
#910BR for 10cc, 30cc and 55cc barrels

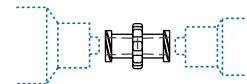

#2160 Luer-to-luer fitting

Memory

The memory feature enables storage of up to eight different time settings that can be recalled and used at the push of a button. Time settings are saved even with power removed and will remain in storage unless changed or erased intentionally. Memory cells are identified as *CEL1* through *CEL8*.

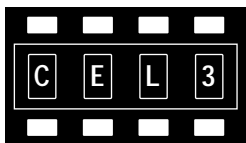

Figure 1

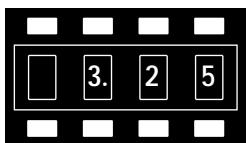

Figure 2

Viewing MEMORY cells

Before saving a time setting in memory, view the memory cells to see which cells are empty or, if all cells are used, which time can be replaced.

To prevent accidental data loss, review the contents of each cell before selecting and storing a new time setting into memory.

1. Press **RUN/SETUP** to place the dispenser in **RUN** mode (**RUN** indicator light on). The current cell number will be displayed. e.g., *CEL3*. (Figure 1)
2. Press **CELL SELECT (up) (down)** to select the cell you wish to use.
3. Press **RUN/SETUP** again to return the dispenser to **SETUP** mode (**SETUP** indicator light on). The time setting stored in the selected cell will be displayed. (Figure 2)

NOTE: To avoid unintentional loss of stored settings, do not press **STEADY/TEACH** in **SETUP** mode (doing so will clear the previously stored cell setting). Always return the dispenser to **RUN** mode after viewing or changing contents.

Saving a time in a MEMORY cell

1. Determine the cell in which a new time value is to be stored, e.g., *CEL1*, *CEL2*... (Refer to "Viewing MEMORY cells" on page 20).
2. Press RUN/SETUP to place the dispenser in SETUP mode (SETUP indicator light on).

■ **Note:** Once cell values are cleared, they cannot be recalled.

3. Press STEADY/TEACH to clear cell contents.
4. Enter the desired time setting by using the TIME SET button or the TEACH function and foot pedal (refer to page 12).
5. Press RUN/SETUP to place the dispenser in RUN mode (RUN indicator light on) and save the setting in cell memory.

The dispenser is now ready to use the preset value you just stored.

To recall and use a time in MEMORY

In the RUN mode, press CELL SELECT (up) (down) to step through the cells until you locate the desired cell. The dispenser is now ready to use the time stored in the selected cell.

Input / Output Connection Instructions

Voltage Initiate Circuit

The 2000XL may be initiated with a 5 to 24 VDC signal across pins 1 and 2. The signal can be momentary (no less than 0.001 seconds) or maintained. A new cycle will begin once power is removed and then applied again.

Mechanical Contact Initiate

The 2000XL can be initiated via the closure of mechanical contacts such as a relay or switch using pins 5 and 7. Closure of the contacts can be momentary (no less than 0.001 seconds) or maintained. A new cycle will begin once the contacts are opened and then closed again.

End-of-Cycle Feedback Circuit

Upon completion of a dispense cycle, an open collector circuit closes and remains closed until the next dispense cycle. This circuit can be utilized to signal back to a host computer, start another device in sequence or other operations that need to be tied into the completion of the dispense cycle.

Upon closure, power from an external 5 to 24 VDC source is allowed to pass through the circuit to operate a load. Power consumption of the load must not exceed 250mA.

I/O Connection

The 9 pin D connector and internal circuitry provide external initiate and end-of-cycle feedback signal. The pin connections are shown below.

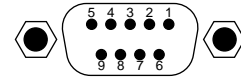

Pin	Function
1.	Initiate +] 5-24 VDC
2.	Initiate -] 5-24 VDC
3.	Output +] 5-24 VDC
4.	Output -] 250mA Max
5.	Contact Closure
6.	Chassis Ground
7.	Contact Closure
8.	Not Used
9.	Not Used

Note: A 9-pin male connector assembly is available from EFD. Order part no. 7154.

Schematic & Parts

- | | | |
|-----|--------------|---|
| 1. | 7104B | Display board assembly |
| 2. | 7109 | Power switch |
| 3. | 7105B | Power supply board assembly, 100 psi |
| | 7105C | Power supply board assembly 5 and 15 psi |
| 4. | 7123 | Transformer |
| 5. | 2-7125-VR | Solenoid assembly* |
| | 2-2003LF-PR | Solenoid assembly* (2000XL-PR5) |
| 6. | 2004B | Air quick-connect |
| 7. | 7131 | Pressure sensor, 100 psi |
| | 7132 | Pressure sensor, 15 psi |
| 8. | 2015A | Foot pedal assembly* |
| 9. | 7111 | Fuse |
| 10. | 7106D | Fuse holder |
| 11. | 2084-1 | Restrictor fitting |
| 12. | 2085 | 1/8 NPT male - 1/4 barb elbow low profile |
| 13. | 2087 | 1/8 NPT male - 1/4 barb elbow |
| 14. | 2094 | 1/8 NPT male - 1/16 barb 60° |
| 15. | 2024-160 | Tubing .170 x 1/4 |
| 16. | 2009-A24 | Power cord* |
| 17. | 7143-01 | Output circuit fuses |
| 18. | 2-2002A-VR | Regulator 0-15 psi* |
| | 2-2002-VR | Regulator 0-100 psi* |
| | 2-2002LP-PR | Regulator 0-5 psi* |
| 19. | 2081A | Air input |
| 20. | 1000INP-AKIT | Input hose assembly* |
| 21. | 2170 | Vacuum transducer |
| 22. | 2-2176-P | Flow control |
| 23. | 2-2017-2000 | Foot pedal receptacle |
| 24. | 2-2010 | Air toggle switch |
| 25. | 2079 | 1/8 NPT male x .170 V barb |

* Not Shown

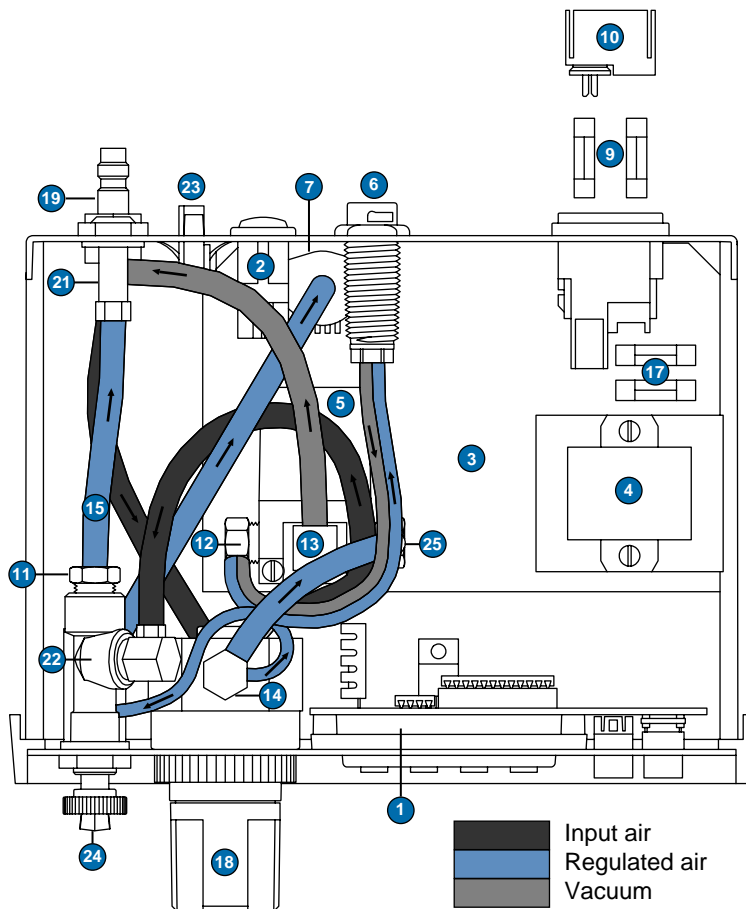

Troubleshooting

If you encounter a problem that you cannot readily solve, call EFD.

Trouble	Possible cause and correction
No power.	Be sure that there is power at the wall receptacle. Check the input power fuse. If the fuse has failed, check the voltage value in the fuse cartridge window. Be sure that it matches the input voltage.
Auxiliary output is not functioning.	<p>Insure that the external voltage to the circuit is between 5 and 24 VDC and that the load does not exceed 250mA.</p> <p>If the output has been overloaded, the fuse may be open. See schematic on page 23 and replace if necessary.</p>
Inconsistent dots.	<ol style="list-style-type: none">1. Check dispensing tip, barrel and material for possible clogging.2. Check dispenser air pressure reading to be sure air pressure is not varying.3. Air bubbles in the material can cause inconsistency. For best results, remove all air bubbles.
Timer seems inoperative.	<p>Check to be sure STEADY mode is off.</p> <p>Note: The EFD timer is very reliable. Any failure will be total, so that no inconsistency is possible. Most questions regarding the timer are resolved by simply turning the STEADY mode off.</p>
Material suck-back.	<ol style="list-style-type: none">1. Use SmoothFlow™ pistons or LV Barriers™ to prevent this (see pages 14 and 15).2. If it occurs, attach an empty barrel, put in STEADY mode, place the barrel in a cup then press the pedal to expel the fluid.3. If problem cannot be corrected, contact an EFD Product Specialist for assistance. Dispensers can be returned to EFD for repair.

Suggestions & Reminders

1. Always use an EFD piston to make your barrel loading, dispensing and handling cleaner, safer and more accurate.

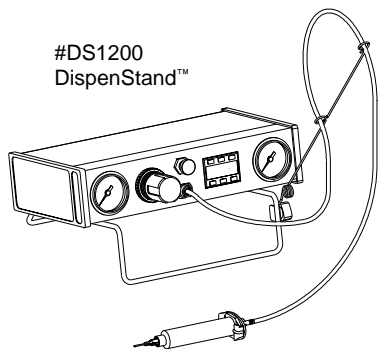

Caution: If you dispense watery-thin fluids and choose **not** to use SmoothFlow™ pistons – do not increase vacuum pressure rapidly and do **not** tip the barrel. Vacuum may pull liquid into the air hose; or when tipped, liquid may flow back into the dispenser.

2. Always use new barrels and tips. Carefully dispose of after use. This procedure ensures maximum cleanliness, prevents contamination and provides proper safety.
3. Do not completely fill the barrel. For most fluids, optimum fill is a maximum 2/3 of the barrel capacity. For cyanoacrylates or watery-thin fluids, optimum fill is 1/2 of the barrel capacity.
4. Use the EFD #DS1200 DispenStand™ (supplied with model 2000XL-CA) to help organize bench space. Adapter hose support keeps hose off of the work area. See illustration.
5. Depending on the type of work you are doing, it may be easier to bring the work to the barrel. Mount the barrel on a stand such as the EFD #7300A.
6. To ensure smooth fluid flow and to make consistent deposits, always have the tip at about a 45° angle to the work surface.

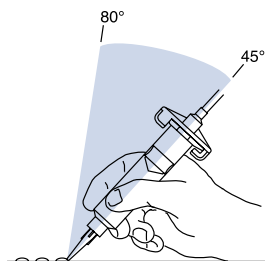
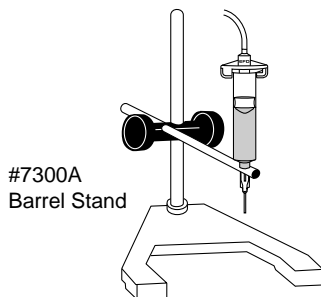

ULTRA System™ Dispensing Components

For complete selection and technical details, please refer to EFD Catalog and price list.

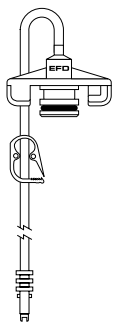

Barrel adapter assemblies

Molded one-piece, yellow, SnapLok™ adapter head with Buna N O-ring, flexible 5/32" O.D. hose, male quick-connect and safety clip.

size	with 3-ft hose	with 6-ft hose
3cc	1000Y5148	1000Y5148-6
5cc	1000Y5149	1000Y5149-6
10cc	1000Y5150	1000Y5150-6
30cc/55cc	1000Y5152	1000Y5152-6

Each box contains the same quantity of barrels and pistons.

Thin to thick fluids (white SmoothFlow™ piston)

size	clear	UV-block	opaque	sets/ box
		amber	black	
3cc	5109CP-B	5109AP-B	5109UP-B	50
5cc	5110CP-B	5110AP-B	5110UP-B	40
10cc	5111CP-B	5111AP-B	5111UP-B	30
30cc	5112CP-B	5112AP-B	5112UP-B	20
55cc	5113CP-B	5113AP-B	n/a	15

Cyanoacrylates and watery-thin fluids (blue LV Barrier™)

size	clear barrel/LV Barrier™/tip cap	sets/box
3cc	5109LV-B	50
10cc	5111LV-B	30

Smooth-flow tapered tips

Molded polyethylene with UV block. Packaged (50) tips per see-through box for easy part identification.

gage	ID	tapered	color
14	.063"	5114TT-B	olive
16	.047"	5116TT-B	grey
18	.033"	5118TT-B	green
20	.023"	5120TT-B	pink
22	.016"	5122TT-B	blue
25	.010"	5125TT-B	red

General purpose precision tips

All EFD dispensing tips incorporate the unique SafetyLok™ color-coded polypropylene hubs. Conveniently packaged (50) tips per see-through box for easy part identification.

gage	ID	1/2" length	hub color
14	.061"	5114-B	olive
15	.054"	5115-B	amber
18	.033"	5118-B	green
20	.024"	5120-B	pink
21	.020"	5121-B	purple
22	.016"	5122-B	blue
23	.013"	5123-B	orange
25	.010"	5125-B	red
27	.008"	5127-B	clear
30	.006"	5130-B	lavender

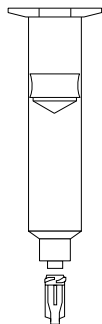

Useful accessories

#2000F755: Five micron filter regulator provides proper air filtering for all dispensers. Order if you do not have dry, clean, filtered factory air supply.

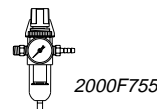

#2000F756: Five micron filter regulator with coalescing filter. Removes liquid aerosols from air supply for cyanoacrylate applications. (Supplied with the 2000XL-CA dispenser.)

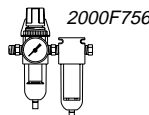

#7300A: Barrel stand, fully adjustable three axes.

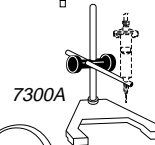

#DS1400: DispenStand™ holds dispenser vertically.

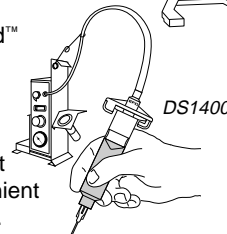

#DS1200: Horizontal stand tilts dispenser at a 14° angle for convenient viewing and operation.

Don't Forget

Now is a good time to ACTIVATE your extended Ten Year No-fault Warranty. Please fill in and return the postage paid Warranty card. Or if you prefer, call the appropriate toll-free number listed below, provide the serial number of your dispenser and respond to a few short questions.



In the US, call 800-556-3484.

In Mexico, call 001-800-556-3484.

In the UK, ring free 0800 585733.

EFD Ten Year No-fault Warranty

All components of EFD dispensers are warranted to the original end user for ten years from date of purchase.

Within the period of this warranty, EFD will repair or replace free of charge any defective component, regardless of fault, on return of the part, or the complete dispenser, prepaid to the factory.

In no event shall any liability or obligation of EFD arising from this warranty exceed the purchase price of the equipment. Before using, user shall determine the suitability of the product for his intended use, and user assumes all risk and liability whatsoever in connection therewith. This warranty is valid only when clean, dry, filtered air is used.

EFD makes no warranty whatsoever of merchantability or fitness for a particular purpose. In no event shall EFD be liable for incidental or consequential damages.



Headquarters: 977 Waterman Avenue, East Providence, RI 02914-1378 USA
Toll Free: 800-556-3484 Mexico: 001-800-556-3484
Telephone: (401) 434-1680 Fax: (401) 431-0237
e-mail: technical@efd-inc.com www.efd-inc.com

Unit 14, Apex Business Centre, Boscombe Road
Dunstable, Bedfordshire LU5 4SB UK
Freephone: 0800 585733 From Ireland: 00800 8272 9444
Telephone: 01582 666334 Fax: 01582 664227
e-mail: sales@efd.co.uk www.efd.co.uk

Sales and service of EFD dispensers and dispensing components is available through EFD authorized distributors in over 30 countries. Please contact EFD U.S.A. for specific names and addresses.



Printed on
recycled paper