



OWNER'S MANUAL
DPF808

Digital Multimedia Player

A. Introduction

Thank you for selecting the Digital Multimedia Player. The main features include an 8" Screen (4:3 Aspect Ratio) Liquid Crystal Display (LCD) monitor, 4 in 1 card reader, CF card reader and USB port. The unit applies the latest state of the art electronics and is designed for use with SD/MMC/MS/XD memory cards, CF memory card and USB memory devices. The unit is constructed to provide years of reliable, trouble-free service. Please read the entire instruction manual supplied with this product prior to operation. The documentation will assist you in obtaining the best equipment performance. All manuals should be stored for later use.

B. Cautions and Warnings

1. Placement

To prevent fire or electric shock, do not expose the DPF808 to rain or moisture. To prevent it from falling do not place the DPF808 on an unstable cart, stand, tripod, bracket or table. Keep the unit away from strong magnets, heat sources, direct sunlight, and excessive dust.

2. Installation

Ensure that the DPF808 is used in accordance with the instructions .

3. Object and Liquid

Do not push objects of any kind into the unit through openings; do not spill or spray liquid of any kind on or in the system (this may result in a fire or electric shock). Do not place anything heavy on the unit. To ensure proper ventilation and proper operation, never cover or block the slots and openings with a cloth or other material.

4. Disassembly

Do not attempt to disassemble the cabinet. There is a risk of electric shock. Contact qualified service personnel if your system is in need of repair.

5. Cleaning Unit

When cleaning, make sure the system is unplugged from the power source. Do not use liquid cleaners or aerosol cleaners. Use a cloth lightly dampened with water for cleaning the exterior of the system only.

C. Contents

1. 1 x DPF808 Digital Picture Frame
2. 1 x Remote Control w/Battery (CR2025)
3. 1 x AC to DC Adapter
4. 1 x Instruction Manual
5. 3 x Snap-on Frames (Black, White and Wood Grain)

D. Positioning Your Frame

Adjustable stand

Rotate the stand to position the frame vertically or horizontally.

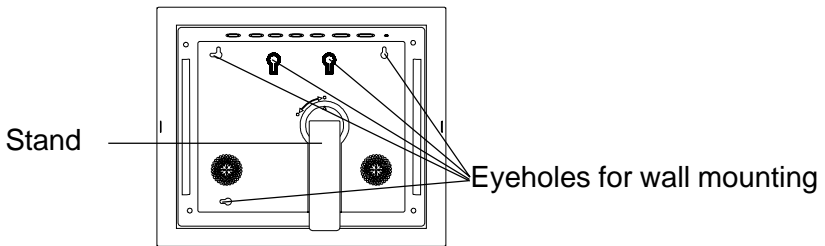

Keep the frame away from strong magnets, heat sources, direct sunlight, or excessive dust.

E. Unit View *Left and Right Side*

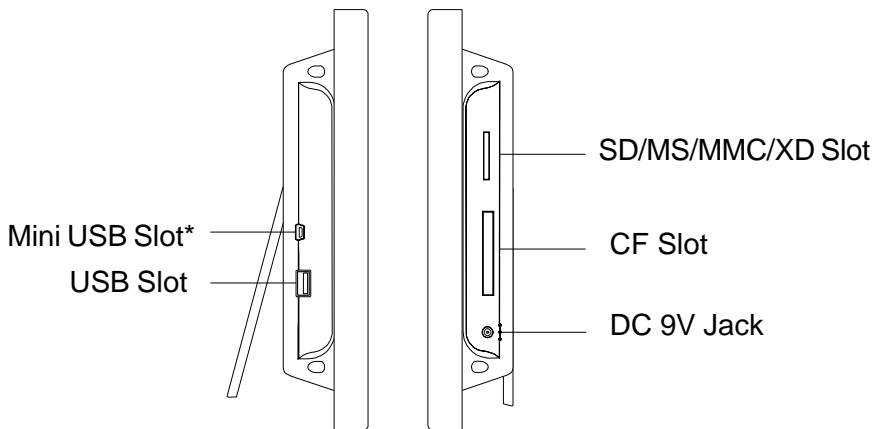

* This connector is used to transfer picture files from a computer to the DPF808. This cable is not supplied but is available at most electronic retail outlets.

Top Side

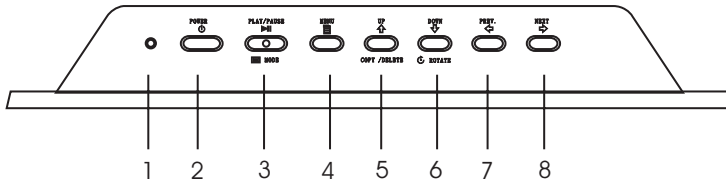

- 1) POWER LED: Lights red when power is on.
- 2) POWER: Press to turn the frame on or off.
- 3) PLAY/PAUSE/MODE: Press to confirm a selection, pause a slide show, or change Modes (Slide Show, Pause, Thumbnail)
- 4) MENU: Press to return to the main menu or to enter the card selection screen when the main menu is displayed.
- 5) UP/COPY/DELETE: Press to move cursor up or to copy/delete a photo.
- 6) DOWN/ROTATE: Press to move cursor down or to rotate a photo in Pause mode.
- 7) LEFT Arrow /PREV.: Press to move cursor left or to view the previous photo.
- 8) RIGHT Arrow/NEXT: Press to move cursor right or to view the next photo.

F. Remote Control Controls and Indicators

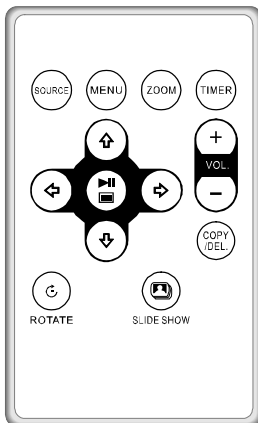

SOURCE	Press to select SD/MS/MMC/XD/CF or USB memory device.
MENU	Press to return to the Previous menu.
ZOOM	When a photo is displayed in the pause mode, pressing ZOOM will enlarge the photo display size by 1x, 2x, or 3x, respectively.
TIMER	Press to enter the Clock mode and Calendar mode.
LEFT/PREV	Press to move cursor left or to access the previous photo.
UP	Press to move cursor up.
PLAY/PAUSE/MODE	Press to confirm a selection, pause a slide show, or change modes (Slide show, Pause, Thumbnail)
DOWN	Press to move cursor down.
RIGHT/NEXT	Press to move cursor to the right or to access the next photo.
VOLUME +/-	Press to increase (+) or decrease (-) the volume.
COPY/DEL.	Press to copy a photo into frame memory or delete a photo from the frame.
ROTATE	Press to rotate the photo in Pause Mode.
SLIDE SHOW	Press to enter Slide Show Mode.

G. Selecting Cards and Viewing Photos

1. Press the POWER button at the top of the frame. The frame turns on (power LED lights red).
2. Insert a card into the card slots or insert a USB memory device into the USB slot. The card and/or USB icon(s) appear momentarily. Press the PREV or NEXT button to select the card you want. Press PLAY/ PAUSE/MODE button to enter the Main Menu.



Note: You can't select a card that has not been inserted in the frame.

3. Use the RIGHT or LEFT button to highlight the PHOTO icon.
4. Press PLAY/PAUSE/MODE once to enter Slide Show mode.
5. Press PLAY/PAUSE/MODE again to enter Pause mode. The frame displays a single image. You can use the PREV. and NEXT button to view the PREV/NEXT photo on the selected media.
6. Press PLAY/PAUSE/MODE the third time to view photos as thumbnails. The thumbnail images appear in a table. Use the PREV, NEXT, UP and DOWN buttons to navigate through the thumbnails.

Note: You can rotate photos clockwise by pressing the ROTATE button when the photo is displayed on the screen in Pause mode.

H. Copying and Deleting Photos

Copying Photos to Your Frame

Please refer to step “**G**” first. If you want to copy the photo, select the photo in Pause mode, then press the UP/COPY/DELETE button. The Copy/Delete pop-up screen appears for about 5 seconds. During this time use the Left or Right button to highlight the COPY icon, then press PLAY/PAUSE/MODE button. A pop-up screen appears indicating “**Copy..... Please Wait!**” as the photo is copied, after which “**Copy Success!**” appears. The frame can only copy photos from cards into internal memory. The internal memory is 128M.

Note: You can rotate photos clockwise by pressing the ROTATE button on the remote control or the Down button on the frame in the Pause mode. Rotated photos are copied in the rotated position.

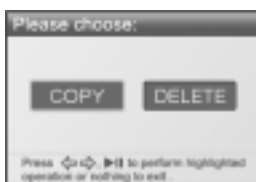

Deleting Photos

Please refer to step “**G**” first. If you want to delete the photo, select the photo in Pause mode, then press the UP/COPY/DELETE button. The Copy/Delete pop-up screen appears for about 5 seconds. During this time use the Left or Right button to highlight the **DELETE** option, then press the PLAY/PAUSE/MODE button. A pop-up screen appears indicating “**Delete? Yes/No**”. Highlight the **Yes** option using the Left or Right button and press the PLAY/PAUSE/MODE button. “**Delete Success!**” appears and the photo is deleted.

Note: The delete function can also delete photos from a memory card or a USB memory device and internal memory.

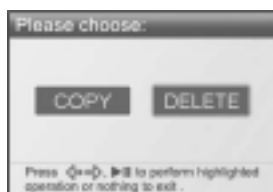

I. Audio Function

- 1) With the Main Menu icons displayed, use the LEFT or RIGHT button to highlight the AUDIO icon. Then press PLAY/PAUSE/MODE to display the audio screen shown below. The song currently playing appears in a highlighted box and the artist and song title scrolls right-to-left. A red play icon appears to the left of the treble clef icon, while a green play icon appears at the top left of the display.
- 2) Press the PLAY/PAUSE/MODE button to pause the play mode; the green play icon changes to the pause icon.
- 3) Press the UP/DOWN/LEFT/NEXT button to select a song and press PLAY/PAUSE/MODE to confirm your selection.
- 4) Press MENU button to exit it.

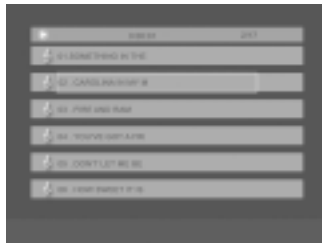

Note:

Press the VOI +/- button on the Remote control to adjust the Volume .

J. Calendar Function

With the main menu icons displayed, use the LEFT/RIGHT button to highlight the CALENDAR icon and press the PLAY/PAUSE/MODE button. Use the LEFT and RIGHT buttons to view the days; use the UP and DOWN buttons to view the months and year. The current date appears at the bottom right of the display. Press MENU button to exit the calendar mode.



K. Clock Function

With the Main Menu icons displayed, use the LEFT/RIGHT button to highlight the CLOCK icon and press the PLAY/PAUSE/MODE button. To make changes to the hour, minute, PM/AM or date, press the PLAY/PAUSE/MODE button to place the unit in change mode. The hour digit will be flashing; press the UP or DOWN button to change the hour or continue pressing the LEFT or RIGHT button to highlight the desired item which you want to make changes to. After all changes have been made, press the PLAY/PAUSE/MODE button to confirm the change. Press MENU button to exit the clock mode.



L. Interfacing the DPF808 to Your Computer

Pictures can be transferred to the DPF808 using your personal computer. To connect to a PC (Personal Computer) you will need a USB cable that has a mini USB connector on one end and a large USB connector on the other end. This cable is not supplied with the DPF808. Most digital cameras come equipped with this type of cable already. If you do not have this cable it can be purchased at most electronics store. (Note: The DPF808 may not work with all versions of Microsoft Windows)

1. With the DPF808 turned off, plug the small end of the USB cable into the small connector on the DPF808. Plug the large USB connector into your PC.
2. Turn on the DPF808.
3. The computer will recognize the DPF808 as a drive on your computer and the following dialog box will appear on your computer screen. If the expected screen does not appear after a minute, then select the "My Computer" icon on your desktop.

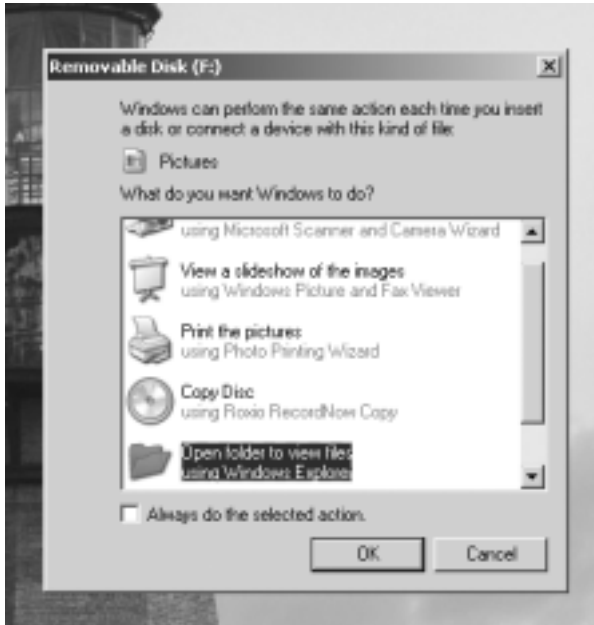

4. Click the OK button. A window similar to the one below will appear on your computer screen.



5. The DPF808 will show up as removable drives. The letters of the drives may be different on your computer, depending on how many drives already exist in your computer. The figure above shows removable drives E:, F: and K: and represents the internal memory of the DPF808 and the two card slots (SD/MMC/MS/xD and Compact Flash). Clicking on the drives will reveal the contents of the internal memory and any memory cards inserted into the card slots. All three drives can be opened into separate windows as shown below. Pictures (JPEGs) can be transferred from your computer to the DPF808 by dragging files from a folder on your computer to any of the three drives on the DPF808.



6. To disconnect the DPF808 from the PC proceed to lower right corner of the screen and select the UNPLUG HARDWARE icon. Wait for the PC to display that is safe to unplug the device. Then disconnect the DPF808.

M. Setting

- 1) With the Main Menu icons displayed, Use the RIGHT or LEFT button to highlight the SETTING icon, then press PLAY/PAUSE/MODE to select.
- 2) Use the UP and DOWN buttons to select the menu item you desire, and press PLAY/PAUSE/MODE to enter the submenu.
- 3) Select the setting you wish using the UP and DOWN buttons, and press PLAY/PAUSE/MODE. When more than one parameter appears in the submenu, the current parameter in effect is highlighted with a square to the right of the parameter.

The setting items and their definitions are showing below:

ITEM	DEFINITION
IMAGE SIZE	Original/Optimal
SLIDE SHOW EFFECT	Photo transition in modes: OFF/ SHUTTER/CROSS COMB/ DISSOLVE/BAR/RANDOM
SLIDE SHOW SPEED	The interval time in seconds between 2 photos (Available interval time: 3S, 5S or 8S)
SLIDE SHOW SHUFFLE	Viewing photo shuffle or in sequence
MUSIC REPEAT (Active only in AUDIO mode)	Set the music repeat mode: ONE/ALL/OFF
RESET SETTINGS	Reset all items to default value
BRIGHTNESS/ CONTRAST	Press UP/DOWN buttons to adjust the contrast, press LEFT/RIGHT arrows to adjust the brightness.
COLOR/TINT	Press UP/DOWN buttons to adjust the color, press LEFT/RIGHT arrows to adjust the tint.
BACKGROUND MUSIC	Activates the background music in Slide Show mode.

ITEM**DEFINITION**

PHOTO FRAME

OFF/PHOTO FRAME: Options 1-5
Select the desired option by using the UP/DOWN buttons and press PLAY/PAUSE/MODE once the desired option is highlighted.

N. Specifications

Functions: JPEG(Does not support progressive JPEG), MP3, Calendar and Clock

Panel size: 8 inch

Power source: DC 9V

Power consumption: 5 W

Operating temperature: 41~95°F, 5~35°C

Weight : 0.83Kg

Dimensions (W x H x D): 10.3 X 8.5 X 1.7 inches
261 X 216 X 43.6 mm

O.Troubleshooting

Problem	Solution
Your digital picture frame won't turn on	The adapter is not securely connected to your picture frame or the power switch is not on.
A memory card is inserted in your digital picture frame but you cannot view your photos.	<ul style="list-style-type: none">* Make sure that the memory card is one of the supported formats and that the files on the card are JPEG images files and not progressive JPEG. (Progressive JPEG not supported).* Turn your digital picture frame off and make sure that the memory card is inserted all the way into the card slot and is inserted correctly. Then turn the frame on again.* This device does not support flash cards larger than 8GB.* Note: Some digital cameras save images in formats other than JPEG. Refer to your camera's manual to determine the output file format.
The frame displays some pictures slower and some pictures faster.	Higher resolution pictures load slower. Try using lower resolution pictures.



90 DAY LIMITED WARRANTY

Applies to Audiovox Video Products

AUDIOVOX ELECTRONICS CORP. (the Company) warrants to the original retail purchaser of this product that should this product or any part thereof, under normal use and conditions, be proven defective in material or workmanship within 90 days from the date of original purchase, such defect(s) will be repaired or replaced with reconditioned product (at the Company's option) without charge for parts and repair labor. A game controller, if supplied, is similarly warranted for ninety (90) days.

To obtain repair or replacement within the terms of this Warranty, the product is to be delivered with proof of warranty coverage (e.g. dated bill of sale), specification of defect(s), transportation prepaid, to the Company at the address shown below.

This Warranty does not extend to the elimination of externally generated static or noise, to correction of antenna problems, to costs incurred for installation, removal or reinstallation of the product, or to damage to digital memory/media devices, gaming devices, discs, speakers, accessories, or electrical systems.

This Warranty does not apply to any product or part thereof which, in the opinion of the Company, has suffered or been damaged through alteration, improper installation, mishandling, misuse, neglect, accident, or by removal or defacement of the factory serial number/bar code label(s). THE EXTENT OF THE COMPANY'S LIABILITY UNDER THIS WARRANTY IS LIMITED TO THE REPAIR OR REPLACEMENT PROVIDED ABOVE AND, IN NO EVENT, SHALL THE COMPANY'S LIABILITY EXCEED THE PURCHASE PRICE PAID BY PURCHASER FOR THE PRODUCT.

This Warranty is in lieu of all other express warranties or liabilities. ANY IMPLIED WARRANTIES, INCLUDING ANY IMPLIED WARRANTY OF MERCHANTABILITY, SHALL BE LIMITED TO THE DURATION OF THIS WRITTEN WARRANTY. ANY ACTION FOR BREACH OF ANY WARRANTY HEREUNDER INCLUDING ANY IMPLIED WARRANTY OF MERCHANTABILITY MUST BE BROUGHT WITHIN A PERIOD OF 24 MONTHS FROM DATE OF ORIGINAL PURCHASE. IN NO CASE SHALL THE COMPANY BE LIABLE FOR ANY CONSEQUENTIAL OR INCIDENTAL DAMAGES FOR BREACH OF THIS OR ANY OTHER WARRANTY, EXPRESS OR IMPLIED, WHATSOEVER. No person or representative is authorized to assume for the Company any liability other than expressed herein in connection with the sale of this product.

Some states do not allow limitations on how long an implied warranty lasts or the exclusion or limitation of incidental or consequential damage so the above limitations or exclusions may not apply to you. This Warranty gives you specific legal rights and you may also have other rights which vary from state to state.

U.S.A. : AUDIOVOX ELECTRONICS CORPORATION, 150 MARCUS BLVD, HAUPPAUGE, NEW YORK 11788
● 1-800-645-4994

CANADA : CALL 1-800-645-4994 FOR LOCATION OF WARRANTY STATION SERVING YOUR AREA

© 2007 Audiovox Electronics Corporation

128-5556G