



## **USER GUIDE**



### **Cisco Unified IP Phone 7975G for Cisco Unified Communications Manager Express Version 7.1**

- 1** Overview, page 2
- 2** Operating Your Phone, page 8
- 3** Phone Features Index, page 23







# 1 Overview

















This guide provides operating instructions and feature descriptions for the Cisco Unified IP Phone 7975G. The Cisco Unified IP phone 7975G is a multiline touch screen phone.

## Physical Description

Your Cisco Unified IP Phone 7975G provides touch-screen access, in addition to soft keys and dedicated buttons, allowing you to place and receive phone calls, put calls on hold, transfer calls, make conference calls, and so on.



	Name	Description
1	Programmable or line buttons 	Depending on the configuration, programmable buttons provide access to: <ul style="list-style-type: none"> <li>• Phone lines and intercom lines (line buttons)</li> <li>• Speed-dial numbers (speed-dial buttons, including the BLF speed-dial feature)</li> <li>• Web-based services (for example, a Personal Address Book button)</li> <li>• Call features (for example, a Privacy, Hold, or Transfer button)</li> </ul> Buttons light to indicate status: <ul style="list-style-type: none"> <li> Green, steady: Active call or two-way intercom call</li> <li> Green, flashing: Held call</li> <li> Amber, steady: Privacy in use, one-way intercom call, DnD active, or logged into hunt group</li> <li> Amber, flashing: Incoming call or reverted call</li> <li> Red, steady: Remote line in use (shared line or BLF status)</li> </ul>
2	Footstand adjustment	Allows you to adjust phone base angle.

	Name (continued)	Description (continued)
3	Display button 	Awakens the touch screen from sleep mode or disables it for cleaning.   No color: Ready for input  Green flashing: Disabled  Green steady: Sleep mode
4	Messages button 	Autodials your voice message service.
5	Directories button 	Provides access to phone directories.
6	Help button 	Activates Help menu (not supported).
7	Settings button 	Provides access to phone settings to change touch screen and ring settings.
8	Services button 	Provides access to phone services.
9	Volume button 	Increases or decreases handset, headset, ringer, or speakerphone volume.
10	Speaker button 	Toggles speaker on and off.
11	Mute button 	Toggles mute on and off.
12	Headset button 	Toggles headset on and off.
13	4-way navigation pad and select (center) button 	Allows you to scroll through menus and highlight items, displays phone numbers from your Placed Calls, when phone is on-hook. Use the Select button to select an item that is highlighted on the screen.  Navigation button <ul style="list-style-type: none"> <li>• Scroll up and down to see menus and highlight items.</li> <li>• Scroll left to open the Details view and see the directory numbers and features assigned to each line button (when on call screen).</li> <li>• Scroll right to close the Details view.</li> </ul> Select button- Scroll to select a line using the Navigation button, then: <ul style="list-style-type: none"> <li>• If the button is mapped to a directory number, and:               <ul style="list-style-type: none"> <li>- The line is idle, press  to initiate a new call.</li> <li>- There is an on-hold call on the line, press  to resume the call.</li> <li>- There is an active call on the line, the Select button has no effect.</li> </ul> </li> <li>• If the button is mapped to a feature, press  to access the feature.</li> </ul>
14	Keypad	Functions like a traditional telephone keypad.
15	Soft keys buttons	Engages the functions displayed on the corresponding LCD tabs.

	<b>Name (continued)</b>	<b>Description (continued)</b>
<b>16</b>	Handset with indicator light	Functions like a traditional handset and provides message waiting indicator light and message-waiting (stutter) tone.
<b>17</b>	Touchscreen	Shows phone's touch screen features.

## Connecting Your Phone

This section shows and describes the connectors on your Cisco Unified IP phone.

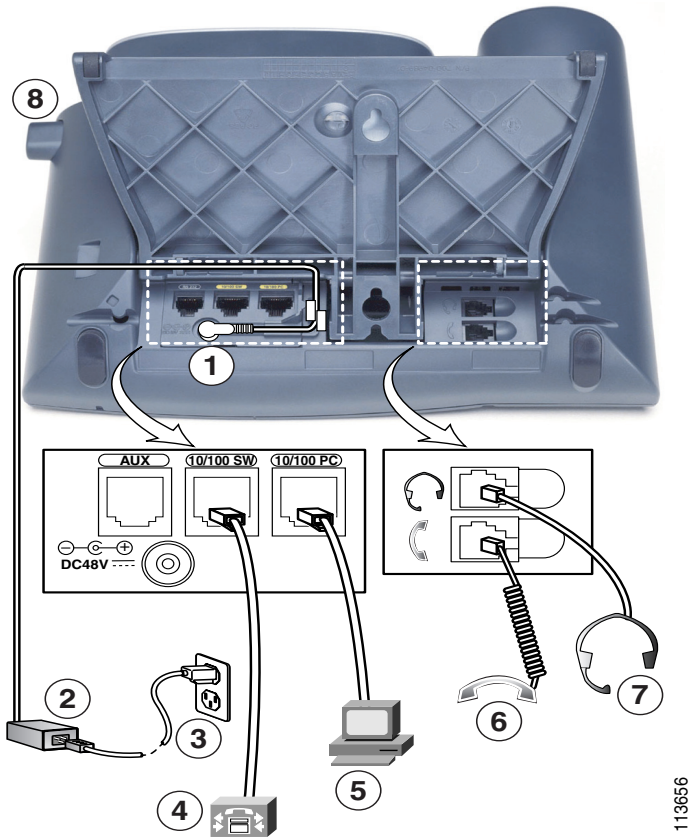

113656

1	DC adapter port (DC48V) for phones not provided with inline power
2	AC-to-DC power supply
3	AC power cord
4	Network port (10/100 SW) for connecting to the network
5	Access port (10/100 PC) for connecting your phone to your computer
6	Handset port
7	Headset port
8	Footstand button

## Adjusting the Handset Rest

When you connect your phone, you can adjust the handset rest so that the receiver does not slip out of the cradle. To adjust the handset:

1. Set the handset aside and pull the square plastic tab from the handset rest.
2. Rotate the tab halfway.
3. Slide the tab back into the handset rest. An extension protrudes from the top of the rotated tab. Return the handset to the handset rest.

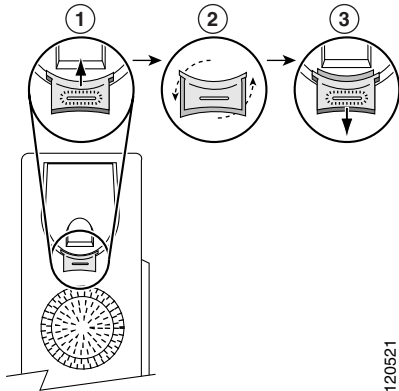

## Touch Screen Features

This is what your main touch screen might look like with active calls and some feature menus open.





1	Primary phone line	Displays the phone number (directory number) for your primary phone line.
2	Programmable button indicators	Programmable buttons  can serve as phone line buttons, speed-dial buttons, phone service buttons or phone feature buttons. Icons and labels indicate how these buttons are configured.
3	Soft key labels	Each displays a soft key function. Soft key labels are touch-sensitive.
4	Status line	Displays audio mode icons, status information, and prompts.
5	Call activity area	Displays current calls per line, including caller ID, call duration, and call state for the highlighted line (standard view). Items in this area are touch-sensitive.
6	Phone tab	Indicates call activity. Press this tab to return to the call activity area, if needed.
7	Feature tabs	Each indicates an open feature menu. Tabs are touch-sensitive.

## Choosing Touch Screen Items

To choose items on your phone's touch screen:

- By touch, press (or tap) touch-sensitive items on the touch screen with your fingertip. Use only your fingertip to press the touch screen because using any other objects could damage the display. Be aware that pressing a phone number can cause the phone to dial the number.
- By item number, press the corresponding number on your keypad. For example, press **4** to choose the fourth item in a menu.
- By scrolling, press the Navigation button to highlight an item. Press a soft key to finish the action, or tap the item on the touch screen with your fingertip.

## Cleaning and Maintaining the Touch Screen

To disable the touch screen for cleaning, press  and hold for more than one second.  flashes. The screen remains disabled for about a minute, unless you enable it.

To enable the touch screen (after disabling it), press  (flashing) and hold for more than one second.

To wake the touch screen from sleep mode, press the touch screen or any button, or lift the handset. After a period of inactivity (determined by your system administrator), the touch screen enters sleep mode to save power. In this mode, the touch screen appears blank and  remains lit.



### Caution





---

Use only a soft, dry cloth to wipe the touch screen. Do not use any liquids or powders on the phone because they can contaminate phone components and cause failures.

---

## Feature Buttons and Menus

To open or close a feature menu, press a feature button:

-  Messages
-  Services
-  Help
-  Directories
-  Settings

To scroll through a list or menu, press the Navigation button.

To go back one level in a feature menu, press **Exit**. Pressing Exit from the top level of a menu closes the menu.











To switch between open feature menus, press a feature tab on your touch screen. Each feature menu has a corresponding tab. The tab is visible when the feature menu is open.

## Line and Call Icons

The difference between lines and calls is as follows:

- Lines: Each corresponds to a directory number that others can use to call you. Your phone can support up to eight lines. To see your phone lines, look at the right side of your touch screen. You have as many lines as you have directory numbers and phone line icons: .
- Calls: Each line can support two calls. Only one call can be active at any time; other calls are automatically placed on hold.

Your phone displays icons to indicate the line and call state.

Icon	Line or Call State	Description
	On-hook line	No call activity on this line.
	Off-hook line	You are dialing a number or an outgoing call is ringing.
	Connected call	You are connected to the other party.
	Ringing call	A call is ringing on one of your lines.
	Call on hold	You have put the call on hold.
	Remote-in-use	Another phone that shares your line has a connected call.
	Authenticated call	Verifies the identities of all phones participating in a call.
	Encrypted call	Identifies phones receiving an encrypted call (your audio) within the Cisco Unified IP network.
	Idle line (BLF)	Indicates the line is idle when using the Busy Lamp Feature (BLF).
	Busy line (BLF)	Indicates the line is busy when using the Busy Lamp Feature (BLF).

## 2 Operating Your Phone

This section describes how to operate your Cisco Unified IP phone and includes information on soft keys and phone features.



**Note** Because of differences in phone and site configuration, not all features described here may apply to your phone. Consult system administrator for more information.

### Soft Key Descriptions

Your Cisco Unified IP phone is equipped with soft keys for call features and options. Soft keys are listed along the bottom of the LCD screen and activated using the corresponding buttons. Soft keys can change according to the state of the phone.

Following is a comprehensive list of soft keys offered on the Cisco Unified IP Phone 7975G. Functions depends on your system configuration.

Soft Key	Function
<<or >>	Navigates to edit characters. Use the backspace soft key to erase digits that you entered incorrectly.
Acct	Account code, consult your system administrator on the use of this soft key.
Answer	Answers an incoming call.
Callback	Notifies callers that the called line is free.
Cancel	Cancels the last selection.
cbarge	Allows callers to join a shared-line call.
CFwdALL	Forwards all calls.
Clear	Clears the directory history.
Confrn	Connects callers to a conference call.
Delete	Deletes a selected number.
Dial	Dials a displayed number.







Soft Key	Function
DnD	Enables the Do-Not-Disturb feature.
Down	Decreases the LCD screen contrast.
EditDial	Selects the number and activates the cursor for editing.
EndCall	Ends the current call.
Exit	Exits from the current selection.
Flash	Provides hookflash functionality for three-way calling and call waiting services provided by the PSTN or Centrex service.
GPickUp	Selectively pick up calls coming into a phone number that is a member of a pickup group.
Hold	Places active call on hold. Resumes an on hold call.
Login	Provides PIN-controlled access to restricted phone features. Contact your local system administrator for additional information.
LiveRcd	Enables the user to record a phone conversation.
MeetMe	Starts a new MeetMe conferences
more	Scrolls through additional soft key options (for example, use the <b>more</b> soft key to locate the DnD soft key).
NewCall	Opens a new line on a speakerphone to a place call.
Ok	Confirms a selection.
Park	Forwards calls to a location from which a call can be retrieved by anyone in the system.
PickUp	Selectively picks up calls coming into another extension.
Play	Plays ring sound samples.
Redial	Redials the last number dialed.
Remove	Removes a conference participant
RmLstC	Removes the Last Participant from the Conference Call.
Resume	Returns to the active call.
Save	Saves the last change.
Search	Initiates a search in the local directory.
Select	Selects the highlighted option.
Trnsfer	Transfers active calls to another extension.
TrnsfVM	Transfers a call to voice mail.
Up	Increases LCD screen contrast.
Update	Updates content.

## Basic—Place a Call

To place a call, use one of the following methods:

- Lift the handset and dial the number.
- Dial the number, and then lift the handset.
- Dial the number, and then press the **Dial** soft key.
- Press the **line** button for your extension, and then dial.
- Press the **Speaker** button, and then dial.
- Press the **New Call** soft key, and then dial.

- If you are using a headset, press the **Headset** button, and then dial. Or, if  is lit, press **New Call** and enter a number.
- Dial the number, and then press the **Headset** button.
- If you have selected a number from a directory, press the **Dial** soft key.
- Press **Redial** to dial the last number, or press the **Navigation** button (with the phone idle) to see your **Placed Calls**.
- If you are placing a call while another call is active (using the same line), press **Hold**, and then press **New Call** and enter the number.
- If you are dialing from the directory, choose  **Missed Calls**, **Received Calls**, or **Placed Calls**. Press the listings on the touch screen.
- If you are dialing on-hook, without a dial tone (predial), enter a number, then go off-hook by lifting the handset, pressing the number on the touch screen, or pressing **Dial**, , or .
- When you predial, your phone anticipates the number you are dialing by displaying matching numbers (if available) from your **Placed Calls** log. This is called Auto Dial. To call a number displayed with Auto Dial, press the number, or scroll to it and go off-hook.



**Note** Use the backspace (<<) soft key to erase digits that you enter incorrectly.

## Additional Options—Place a Call

To place a call while another call is active (using a different line):







1. Press  for a new line. The first call is automatically placed on hold.
2. Enter a number.

To dial from a Personal Address Book (PAB) entry:

1. Press  > **Personal Directory** to log in.
2. Choose **Personal Address Book** and search for a listing.



## Answer a Call

To answer a call, use one of the following methods:

- Press  to answer with a headset, if unlit. Or, if  is lit, press **Answer** or  (flashing).
- Press , to answer with the speakerphone, press **Answer**, or  (flashing).
- Press **Answer** to switch from a connected call to answer a new call, or, if the call is ringing on a different line, press  (flashing).
- Press **Answer** to answer a call using call waiting.
- Press **iDivert** to send a call to your voice messaging system.

## End a Call

To end a call, use one of the following methods:

- Hang up the handset or press **EndCall**.
- If you are using a headset, press . Or, to keep headset mode active, press **EndCall**.
- If you are using the speakerphone, press  or **EndCall**.
- Press **EndCall** to hang up one call, and preserve another call on the same line. If necessary, remove the call from hold first.

## Hold and Resume a Call

Engaging the Hold feature typically generates music or a beep. A call-on-hold is indicated by the  icon.

To put a call on hold:

1. Make sure the call you want to put on hold is highlighted.

2. Press **Hold**.

To remove a call from hold on the current line:

1. Make sure the appropriate call is highlighted.
2. Press **Resume**.

To remove a call from hold on a different line, press  (flashing) for the appropriate line. If a single call is holding on this line, the call automatically resumes. If multiple calls are holding, scroll to the appropriate call and press **Resume**.

## Mute a Call

With Mute enabled, you can hear other parties on a call and they cannot hear you. You can use Mute in conjunction with the handset, speakerphone, or a headset.

Press  to toggle Mute on.

Press  to toggle Mute off.

## Manage Call Waiting

If you are on a call when a second call comes in, you hear a call-waiting tone or see a flashing indicator light on the handset rest, depending on the configuration of your phone.

To answer the new call on the same line:

1. Use the **Navigation** button to select the call.
2. Press the **Answer** soft key to answer the call. The call on the other line is automatically put on hold.

To return to the original call:

1. Use the **Navigation** button to reselect the call.
2. Press the **Resume** soft key to reconnect to the call.

For calls on a separate line:

- Press the **Line** button for the incoming call. The call on the other line is automatically put on hold.

To return to the original call:

- Press the **Line** button associated with the original call.

## Retrieve Voice Messages

To retrieve voice messages:

1. Select an available Cisco Unified IP phone line by lifting the handset, pressing the speakerphone button, or pressing a line button. Listen for the dial tone.
2. Press the **Messages** button, and follow the voice instructions.



---

**Note** When you have one or more new messages, the message-waiting indicator (MWI) light on your handset is lit. The MWI works only if you have the MWI configured on your phone.

---



---

**Note** Your company determines the voice message service that your phone system uses. For the most accurate and detailed information, see the documentation for your voice message service.

---

## Adjust the Volume for the Current Call

To adjust the handset, speakerphone, or headset volume for the current call:

1. During a call, press the **Up** or **Down Volume** button.
2. Press the **Save** soft key to apply the new volume level to future calls.

## Adjust the Ring Volume

- Press the **Up** or **Down Volume** button while the handset is in its cradle.

## Select the Ring Type

To change the ringer sound:

1. Press the **Settings** button.
2. Press **2** for Ring Type, or use the **Navigation** button to scroll to Ring Type and press the **Select** soft key.
3. Use the **Navigation** button to scroll through the list of ring types. Press the **Play** soft key to hear samples.
4. Highlight the ring you want, and then press the **Select** soft key.
5. Press the **Ok** soft key to select your setting.
6. Press the **Save** soft key to save the setting, or press **Cancel** to exit to the previous menu without changing the setting.
7. Press the **Exit** soft key to return to the main directory menu.

## Adjust the Display Contrast

To adjust the contrast in your LCD display:

1. Press the **Settings** button.
2. Press **1** for Contrast, or use the **Select** soft key.
3. Use the **Down** or **Up** soft key to change the contrast.
4. Press the **Ok** soft key.
5. Press the **Save** or **Exit** soft key.
6. Press the **Ok** soft key to select your contrast setting.
7. Press the **Save** soft key to save the setting, or press **Cancel** to exit to the previous menu without changing the setting.
8. Press the **Exit** soft key to return to the main directory menu.



---

**Note** Press the backspace (<<) soft key to erase digits that you enter incorrectly.

---

## Divert Incoming Calls

To forward any incoming call to the call-forward destination set on the Cisco Unified IP phone:

- Press the **DnD** soft key.



---

**Note** If the call-forward destination is not set, pressing the **DnD** soft key disables the ringer.

---

## Whisper Intercom

The Whisper Intercom feature allows the user to make an intercom call to a busy extension. The recipient can hear the caller or hear the whisper intercom, and the original caller on the receiving phone does not hear the whisper intercom. The phone receiving a whisper intercom displays the extension and name of the party initiating the whisper intercom and a zipzip tone is played before the called party hears the caller's voice. The receiving party needs to select the intercom line button on their phone to speak to the caller.



---

**Note** For intercom users to know whether the intercom is using one-way or two-way audio, the lamps for both intercom buttons are colored amber for one-way whisper intercom and green for two-way audio.

---

To place an intercom call:

- Dial the intercom directory number from your intercom line. The intercom recipient hears the intercom caller audio without answering the call.

To answer an intercom call:

- Press the intercom button to talk to the intercom caller.

To end a whisper intercom call:

- Press **Endcall**.

## Place a Priority (Precedence) Call





In some specialized environments, such as military or government offices, you might need to make and receive urgent or critical calls. If you need this specialized call handling, your system administrator can add Multilevel Precedence and Preemption (MLPP) to your phone.

Keep these terms in mind:

- *Precedence* indicates the priority associated with a call.
- *Preemption* is the process of ending an existing, lower priority call while accepting a higher priority call that is sent to your phone.

### Priority Level of an MLPP Call

To see the priority level of an MLPP call, look for an MLPP icon on your phone screen:

-  Priority Call
-  Medium priority (immediate) call
-  High priority (flash) call
-  Highest priority (flash override) or Executive Override call

Higher priority calls are displayed at the top of your call list. If you do not see an MLPP icon, the priority level of the call is normal (routine).



---

**Note** Contact your system administrator for a list of corresponding precedence numbers for calls.

---

### To Make a Priority (Precedence) Call:

Enter the MLPP access number (provided by your system administrator) followed by the Precedence level (0-4) and the phone number.



---

**Note** If you enter an invalid MLPP access number, a verbal announcement alerts you of the error.

---

### To Answer an MLPP Call:

End an active call (if necessary) and answer the MLPP call.

If the active call has lower precedence than the incoming call, then the active call is preempted.

### Tips

- When you are receiving a priority (precedence) call, an MLPP icon on your phone screen indicates the priority level of the call.
- When you make or receive an MLPP-enabled call, you hear special ring tones and call-waiting tones different from the standard tones.

- When you or the other party are receiving a call that must preempt the current call, disconnect immediately to allow the higher priority call to ring through.
- When you have more than 1 active call, the call with the lowest precedence is preempted. Similarly, for outgoing calls, the call with lower precedence is preempted first.

## Park a Call (SCCP)

Call park allows a user to place a call on hold at a designated parking slot from which the call can be retrieved by anyone on the system.



---

**Note** Contact your system administrator for your call park slot number.

---

To park a call:

- Press the **Park** soft key.

The Cisco Unified Communications Manager Express system automatically selects an available call park slot and displays the number on the Cisco Unified IP phone screen.

To park a call to a specific call park slot:

- Press the **Transfer** soft key followed by the call park slot number provided by your system administrator.

To retrieve a parked call:

- If your phone receives a call park notification, press the **PickUp** soft key followed by the asterisk (\*).
- Press the **PickUp** soft key followed by the call park slot number.

## Park a Call (SIP)

Call park allows a user to place a call on hold at a designated parking slot from which the call can be retrieved by anyone on the system.



---

**Note** Contact your system administrator for your call park slot number.

---

To park a call:

- Press the **Park** soft key.

The Cisco Unified Communications Manager Express system automatically selects an available call park slot and displays the number on the Cisco Unified IP phone screen.

To retrieve a parked call:

- Dial the park slot extension.

To park a call to a directed call park slot:

- Press the **Transfer** soft key followed by the call park slot number provided by your system administrator.

To retrieve a call parked at a directed call park slot:

- Dial the retrieval park-slot extension.

## Pick Up Calls

To pick up a call that is on hold or a call that is ringing at another extension:

1. Press the **PickUp** soft key.
2. Dial the extension number of the Cisco Unified IP phone that you want to pick up. Control of the call is transferred to your phone.

To selectively pick up a call ringing at a number that belongs to a pickup group:

- Press the **GPickUp** soft key. If only one pickup group is defined in the entire Cisco Unified Communications Manager Express system, control of the call is transferred to your phone.
- If the ringing phone and your phone are in the same pickup group, press the asterisk (\*) to transfer control of the call to your phone.
- If the ringing phone and your phone are in different pickup groups, dial the pickup group number where the phone is ringing to transfer control of the call to your phone.

## Call-Blocking (Toll Bar) Override

Call blocking which prevents unauthorized use of phones is implemented by matching a pattern of specified digits during a specified time of day and day of week or date. The call-blocking override feature allows individual phone users to override the call blocking that has been defined.



---

**Note** Contact your system administrator for your personal identification number (PIN).

---

To place calls when call-blocking is enabled:



1. Press the **Login** soft key on the Cisco Unified IP phone.
2. Enter the PIN that is associated with the phone.

## View Multiple Calls

In standard viewing mode, your phone displays calls as follows for the highlighted line:

- Calls with the highest precedence and longest duration display at the top of the list.
- Calls of a similar type are grouped together. For example, calls that you have taken are grouped near the top, and calls on hold are grouped last.

To view calls on another line, use the following method:

1. Press  .
2. Immediately press the line button  .

To switch to call overview mode, press  for the highlighted line. The phone switches to call overview mode, displaying only one call per line. The displayed call is either the active call or the held call with the longest duration.

To return to standard viewing mode, press  , then immediately press the line button.

## Transfer a Call

To transfer a selected call to another number, you can use blind transfer or consultative transfer:

### Blind Transfer

Immediately redirects the call without allowing you to speak to the transfer recipient (the person to whom you are transferring the call).

To make a blind transfer call:

1. During a call, press the **Trnsfer** soft key. The call is placed on hold.
2. Dial the number to which you want to transfer the call.

### Consultative Transfer

Redirects the call after first allowing you to speak to the transfer recipient.

To make a consultative transfer:

1. During a call, press the **Trnsfer** soft key. The call is placed on hold.
2. Dial the number to which you want to transfer the call.
3. Wait for the call to be answered. Speak to the transfer recipient. Then press the **Trnsfer** button or hang up the handset.

4. If the transfer fails, press the **Resume** soft key to return to the original call.

## Cancel Transfer

1. To cancel your consultative call-transfer attempt:
  - Press the **EndCall** soft key.
2. To reconnect to the original caller:
  - Press the **Resume** soft key.

## Transfer to Voice Mail

To transfer a call to the recipient's voice mail:

1. Press **TrnsfVM**.
2. Enter the recipient's extension number and press **TrnsfVM** again.

## Forward All Calls

To forward all incoming calls to another number:

1. Press the **CFwdALL** soft key. You hear a confirmation beep.
2. Dial the number to which you want to forward all your calls. Dial the number exactly as you would if you were placing a call to that number. Remember to include locally required prefix numbers.  
The phone display is updated to show that calls are to be forwarded.
3. Press the pound key (#) or the **EndCall** soft key.



---

**Note** To forward calls to voice mail, manually enter the voice-mail number, or use the soft key and button sequence of **CFwdALL** soft key plus the **Messages** button, followed by the **EndCall** soft key.

To forward calls to a speed-dial number, use the soft key and button sequence of the **CFwdALL** soft key plus a **speed-dial** button, followed by the **EndCall** soft key.

---

To cancel call forwarding:

- Press the **CFwdALL** soft key.

## Live Record a Call

Call initiators can use the **LiveRcd** soft key to record an active call, private line or conference call. To record a call:

1. Press the **LiveRcd** soft key. This puts the other party on-hold and initiates a call to the configured live record number.
2. Press the **LiveRcd** soft key again to stop the recording.

## Join a Shared-Line Call (SCCP)

User can join a call on a shared line using the **cBarge** soft key.

To join the shared-line call:

1. Highlight the remote-in-use call that you want to join.
2. Press **more** to navigate to **cBarge** and press **cBarge**.

## Join a Shared Line Call (SIP)

User can join a non-private call on a shared line call by using either **Barge** or **cBarge** soft keys.

- **Barge** allows you to add yourself to the call by hosting the conference on your phone and does not allow others to join the conference.



- **cBarge** allows you to add yourself to the conference and allows others to join the conference.

To join a shared line call:

1. Highlight the remote-in-use call that you want to join.
2. Press **Barge** or **cBarge** to join the call.

### Tips

- When you **Barge** a call, other parties hear a beep announcing your presence. You are disconnected from a call that you have joined using **Barge** if the call is put on hold, transferred, or turned into a conference call by the **Barge** initiator.
- If a phone that is using the shared line has Privacy enabled, call information and **Barge/cBarge** soft keys do not appear on the other phones that share the line.
- You are disconnected from a call that you joined using **Barge** if the call is put on hold, transferred, or turned into a conference call.

## Hold a Shared-Line Call (SIP)

Users can put calls on a shared line on hold like calls on a nonshared line.

To place a call on hold while on a shared-line call:

- Highlight the call that you want to put on hold.
- Press the **Hold** soft key.

## Resume a Shared Line Call (SIP)

Users can resume a nonprivate call placed on hold on a shared line call.

To resume a shared line call:

1. Highlight the call that you want to resume.
2. Press **Resume** to resume the call.



### Tip

- When a shared-line call is placed on hold, a flashing green shared line button notifies all the other phones with the shared-line directory number that the call can be resumed.

## Enable Privacy on Shared-Line (SIP)

Users can prevent others from viewing, barging or resuming a Shared-Line Call by enabling the phone's privacy feature.

To prevent other from viewing or barging calls:

1. Press the privacy line button . The private icon  next to an amber line button verifies that privacy is on.
2. Press privacy button again to disable privacy.

### Tips

- The privacy button is not displayed on the shared-line phone by default. Your system administrator should enable privacy button on a per phone basis.
- Privacy is enabled by default for shared-lines. Your system administrator can change the default privacy setting globally or on a per phone basis.
- Calls placed on hold with privacy enabled have privacy disabled by default. Your system administrator can change the default privacy on hold setting globally.

## Place and Establish Conference Call

To place a conference call:

1. During a call, press the **more** soft key and then the **Confrn** soft key to open a new line and put the first party on hold.
2. Place a call to another number.
3. When the call connects, press **Confrn** again to add the new party to the call.

To establish a conference call between two- and three-party calls to a Cisco Unified IP phone, one active and the other on hold:

- Press the **Confrn** soft key on the Cisco Unified IP phone.

To establish a conference call between two- and three-party calls already present on a Cisco Unified IP phone, using separate line buttons, one active and the other on hold:

1. Press the **Confrn** soft key on the Cisco Unified IP phone.
2. Press the **Line** button of the call you want to add to the conference.



---

**Note** Your system administrator will have configured the system for three-party or eight-party ad-hoc conferences.

---

## Place MeetMe Conference Call

To place a MeetMe conference call:

1. Obtain a MeetMe conference number from your system administrator.
2. Distribute the MeetMe conference number to all the participants.
3. Go offhook, press the MeetMe softkey, and dial the MeetMe conference number. All other participants join the meeting by dialing into the MeetMe conference number.
  - To end the MeetMe conference call, all participants must hang up the handset or press the **EndCall** soft key.

## End a Conference Call

- To end the conference call:

1. Hang up the handset, or press the **EndCall** soft key.



---

**Note** Depending on configuration, when the conference call initiator disconnects, the conference call terminates.

---

## Alternate Methods to End Conference Call

Call initiators may use one of the following methods (functionality will vary according to your system configuration):

- To disconnect from the conference, hang up the handset. The other parties remain on the conference call.

## Place Call from Your Local Directory

To access the local phone directory established by the system administrator:

1. Press the **Directories** button.
2. Press the **Navigation Up** or **Down** button or press **4** to select the Local Directory.
3. Press the **Navigation Up** or **Down** button to select the Last, First, or Number field search option.
4. Using the keypad, enter the last name or first name for the entry.

When entering letters, select the appropriate number key of the letter you want, and press that key a number of times that equals the position of the target letter. For example, to enter a B, press the 2 key two times, and to enter a C, press the 2 key three times. Use the backspace (<<) soft key to make corrections while entering data.

5. Press the **Search** soft key to find your selection.
6. If your search results in multiple listings, use the **Navigation Up** or **Down** button to select the correct number.

7. Press the **Dial** soft key to dial the selected number.

## Program Personal Speed-Dial Buttons

After an system administrator defines one or more speed-dial instances for a Cisco Unified IP phone, you can reprogram numbers that are not locked or program numbers into an instance that has an empty dial string:

1. Select an available phone line by lifting the handset, by pressing the **NewCall** soft key, or by pressing a line button. Listen for the dial tone.
2. Press the pound key (#).
3. Press the speed-dial button that you want to program. A short beep confirms that you are starting to program this button.
4. Enter the speed-dial number. The digits appear on the phone display. When you are entering speed-dial numbers, use the backspace (<<) soft key to erase digits that you entered incorrectly.
  - To remove a speed-dial number without replacing it with a new one.
1. Press the pound key (#).
2. Press the same speed-dial button a second time to indicate that you are done entering the speed-dial digits and to store the new speed-dial number.
3. Hang up the handset, or press a new speed-dial button and repeat this procedure.

## Place a Call from Your System Speed-Dial Directory

To place a call from your system speed-dial directory:

1. Select an available Cisco Unified IP phone line (off hook or **NewCall**) and get a dial tone.
2. Press the **Directories** button, or use the **Navigation** button to locate Directory and then press the **Select** soft key.
3. Use the **Navigation** button to scroll through the options. Use the **Select** soft key to select speed-dial options.
  - Press **5** for the Local Speed Dial.
  - Press **6** for the Personal Speed Dial (functionality varies depending on your system configuration).
4. Use the **Navigation** button to scroll through the speed-dial phone list.
5. To dial the selected phone number, either press the **Select** soft key or enter the number on the keypad.
6. Press the **Exit** soft key to go to the directory menu.

## Place a Call Using Your Extension Mobility (EM) Profile

Extension Mobility (EM) allows the user to temporarily configure a Cisco Unified IP phone to function as user's own phone. Once the user is logged-in to EM, the phone adopts the user's profile, including the line buttons, features, and established services.

To log-in to Extension Mobility:

1. Press  and select Extension Mobility.
2. Enter your User ID and Password.
3. Press **Submit**. The phone will temporarily configure user profile and settings.



---

**Note** Your system administrator must configure Extension Mobility for you.

---

## Place a Call from Your Personal Speed-Dial

To place a call from your Personal Speed-Dial using My Phone Apps, use the following method:

1. Log-in to **Extension Mobility**.
2. Select **My Phone Apps** and scroll down to **Personal Speed Dial**.
3. Select **Personal Speed Dial**

4. Add a Label and Number
5. Go back to **My Phone Apps** and press **Reset Phone**. Your Personal Speed-Dial number will appear on the phone display screen.

## Switching an In-Progress Call to Another Phone Using SNR

The Single Number Reach (SNR) feature allows you to switch an in-progress call on your desktop phone to your remote destination phone, such as a mobile phone. You can pick up an in-progress call on the desktop phone or remote destination phone without losing the call. All unanswered calls are forwarded to your voice mail.



---

**Note** Your system administrator must configure this feature for your IP Phone. Contact your system administrator for more information.

---

### Switch an in-progress Call from Your Desktop Phone to Your Remote Destination Phone

To switch an in-progress call on your desktop phone to your remote destination phone:

1. Press the **Mobility** soft key.
2. Select **Send Call to Mobile Phone**.
3. Answer the in-progress call on your remote destination phone.

The desktop phone line button turns red and handset icons and the calling party number appear on the phone display. You cannot use same phone line for any other calls, but if your desk phone supports multiple lines, you can use another line to make or receive calls.

### Switch an in-progress Call from a Remote Destination Phone to Your Desktop Phone

1. Press **Resume** on your desk phone and start talking on your desk phone.
2. Hang up the call on your remote phone to disconnect the phone.

### Change Your Remote Destination Phone Number

You can replace the existing remote destination phone number with a new phone number.

To change the existing remote destination phone number:

1. Press **Services** button and select **My Phone Apps**.
2. Select **Single Number Reach**.
3. Use << soft key to type your new remote destination phone number. Make sure you add the appropriate dialing prefix or access code (if applicable) to your remote destination number.
4. Press **Submit**.

### Enable or Disable Single Number Reach

You can enable or disable Single Number Reach (SNR) on your phone by using the **Mobility** soft key.

- To disable SNR, press **Mobility** soft key and select **Disable Mobile Connect**.
- To enable SNR, press **Mobility** soft key and select **Mobile Connect On**.

## View Call History

To view recent missed, received, or placed calls:

1. Press the **Directories** button.
2. Use the **Navigation** button to scroll and select the desired call list. Press the **Select** soft key, or

- Press **1** on the keypad for Missed Calls.
  - Press **2** on the keypad for Received Calls.
  - Press **3** on the keypad for Placed Calls.
3. Press the **Exit** soft key to return to the previous directory menu.

## Place a Call from Call History

To place a call to a number in the call history list:

1. Use the **Navigation** button to scroll through the call history list.
2. Use the **Select** soft key to select a phone number. The digits will appear on the phone display.
3. To dial the number as it appears on the phone display:
  - Press the **Dial** soft key.

To edit the number on the phone display before dialing:

1. Press the **EditDial** soft key to place the cursor at the beginning of the number on the phone display.
2. Use the keypad to edit the digits as needed. Use the backspace (<<) soft key to erase digits that you enter incorrectly.
3. Press the **Dial** soft key to place the call.

## Clear Call History

To clear all numbers in the directory histories

- Press the **Clear** soft key.



---

**Note** The **Clear** soft key clears all call history lists. Selective clearing of call history lists is not supported.

---

## Use the Intercom Feature

Cisco Unified Communications Manager Express supports intercom functionality for one-way and press-to-answer voice connections using a dedicated pair of intercoms on two phones that speed-dial each other.

To use the intercom feature:

1. Press the **Speaker** button and get the dial tone.
2. Press the speed dial key or dial the directory number to start the intercom call.



---

**Note** The called Cisco Unified IP phone automatically answers the call in speakerphone mode with mute activated or deactivated depending on configuration. The phone will beep to alert the recipient to the incoming call.

---

To respond to an intercom call:

- If Mute key is lighted, Press the **Mute** button, or lift the handset.
- If Mute key is not lighted, reply to caller handsfree.

## Activate Do Not Disturb

For visual call alerting and information without audible ringing, use Do Not Disturb (DnD). Calls receive normal call-forward-busy and no-answer treatment.



To activate the Do-Not-Disturb feature:

1. Press the **more** soft key to locate the **DnD** soft key.
2. Press the **DnD** soft key. A text message displays to indicate that the phone is in Do-Not-Disturb mode.



To deactivate the Do-Not-Disturb feature, repeat Steps 1 and 2 in idle state.

## Customizing the Touch Screen

To change the touch screen brightness:

1. Choose  > **User Preferences > Brightness.**
2. To make adjustments, press **Up**, **Down** or  .
3. Press **Save**, or press **Cancel**.

To adjust the touch screen to accommodate your viewing angle:

1. Choose  > **User Preferences > Viewing Angle.**
2. To make adjustments, press **Up**, **Down** or  .
3. Press **Save**, or press **Cancel**.

To change the background image:

1. Choose  > **User Preferences > Background Images.**
2. Scroll through available images and press **Select** to choose an image.
3. Press **Preview** to see a larger view of the background image.
4. Press **Exit** to return to the selection menu.
5. Press **Save** to accept the new image, or press **Cancel**.

To change the language on your touch screen:

1. Log in to your User Options web pages.
2. Access your user settings.

To change the line text label:

1. Log in to your User Options web pages.
2. Access your line label settings.

### 3 Phone Features Index

This section provides an alphabetical list of features for your Cisco Unified IP phone. Features supported in both SIP and SCCP protocols are marked as “Supported” and features not supported in either one of the protocols are marked as “Not Supported”. However, there are differences in how the feature works based on the call protocol.

**Table 1** *Features supported in SIP and SCCP protocols.*

<b>Phone Features</b>	<b>SIP</b>	<b>SCCP</b>
Activate Do Not Disturb 21	Supported	Supported
Additional Options—Place a Call 10	Supported	Supported
Adjust the Display Contrast 12	Supported	Supported
Adjust the Ring Volume 12	Supported	Supported
Adjust the Volume for the Current Call 11	Supported	Supported
Answer a Call 10	Supported	Supported
Basic—Place a Call 9	Supported	Supported
Call-Blocking (Toll Bar) Override 15	Not Supported	Supported
Cancel Transfer 16	Supported	Supported
Clear Call History 20	Supported	Supported
Divert Incoming Calls 12	Supported	Supported
Enable Privacy on Shared-Line (SIP) 17	Supported	Not Supported
End a Call 10	Supported	Supported
End a Conference Call 18	Supported	Supported
Forward All Calls 16	Supported	Supported
Hold and Resume a Call 10	Supported	Supported
Join a Shared Line Call (SIP) 16	Not Supported	Supported
Join a Shared-Line Call (SCCP) 16	Not Supported	Supported
Live Record a Call 16	Supported	Supported
Manage Call Waiting 11	Supported	Supported
Mute a Call 11	Supported	Supported
Park a Call (SCCP) 14	Not Supported	Supported
Park a Call (SIP) 14	Not Supported	Supported
Pick Up Calls 14	Supported	Supported
Place a Call from Call History 20	Not Supported	Supported
Place a Call from Your Personal Speed-Dial 19	Supported	Supported
Place a Call from Your System Speed-Dial Directory 19	Not Supported	Supported
Place a Call Using Your Extension Mobility (EM) Profile 19	Supported	Supported
Place a Priority (Precedence) Call 13	Supported	Supported
Place and Establish Conference Call 18	Supported	Supported
Place Call from Your Local Directory 18	Not Supported	Supported
Place MeetMe Conference Call 18	Not Supported	Supported
Program Personal Speed-Dial Buttons 19	Supported	Supported
Resume a Shared Line Call (SIP) 17	Supported	Supported
Retrieve Voice Messages 11	Supported	Supported

**Table 1**      *Features supported in SIP and SCCP protocols.*

<b>Phone Features</b>	<b>SIP</b>	<b>SCCP</b>
Select the Ring Type 12	Supported	Supported
Switching an In-Progress Call to Another Phone Using SNR 20	Not Supported	Supported
Transfer a Call 15	Supported	Supported
Transfer to Voice Mail 16	Not Supported	Supported
Use the Intercom Feature 20	Supported	Supported
View Call History 20	Supported	Supported
View Multiple Calls 15	Supported	Supported
Whisper Intercom 12	Not Supported	Supported





**Americas Headquarters**  
Cisco Systems, Inc.  
170 West Tasman Drive  
San Jose, CA 95134-1706  
USA

[www.cisco.com](http://www.cisco.com)  
Tel: 408 526-4000  
800 553-NETS (6387)  
Fax: 408 527-0883

**Asia Pacific Headquarters**  
Cisco Systems, Inc.  
168 Robinson Road  
#28-01 Capital Tower  
Singapore 068912

[www.cisco.com](http://www.cisco.com)  
Tel: +65 6317 7777  
Fax: +65 6317 7799

**Europe Headquarters**  
Cisco Systems International BV  
Haarlerbergpark  
Haarlerbergweg 13-19  
1101 CH Amsterdam  
The Netherlands

[www-europe.cisco.com](http://www-europe.cisco.com)  
Tel: 31 0 800 020 0791  
Fax: 31 0 20 357 1100

**Cisco has more than 200 offices worldwide. Addresses, phone numbers, and fax numbers are listed on the Cisco Website at [www.cisco.com/go/offices](http://www.cisco.com/go/offices).**

CCVP, the Cisco logo, and Welcome to the Human Network are trademarks of Cisco Systems, Inc.; Changing the Way We Work, Live, Play, and Learn is a service mark of Cisco Systems, Inc.; and Access Registrar, Aironet, Catalyst, CCDA, CCDP, CCIE, CCIP, CCNA, CCNP, CCSP, Cisco, the Cisco Certified Internetwork Expert logo, Cisco IOS, Cisco Press, Cisco Systems, Cisco Systems Capital, the Cisco Systems logo, Cisco Unity, Enterprise/Solver, EtherChannel, EtherFast, EtherSwitch, Fast Step, Follow Me Browsing, FormShare, GigaDrive, HomeLink, Internet Quotient, IOS, iPhone, IP/TV, IQ Expertise, the IQ logo, IQ Net Readiness Scorecard, iQuick Study, LightStream, Linksys, MeetingPlace, MGX, Networkers, Networking Academy, Network Registrar, PIX, ProConnect, ScriptShare, SMARTnet, StackWise, The Fastest Way to Increase Your Internet Quotient, and TransPath are registered trademarks of Cisco Systems, Inc. and/or its affiliates in the United States and certain other countries.

All other trademarks mentioned in this document or Website are the property of their respective owners. The use of the word partner does not imply a partnership relationship between Cisco and any other company. (0711R)

