

# 60cm Built In Ceramic Cooktop

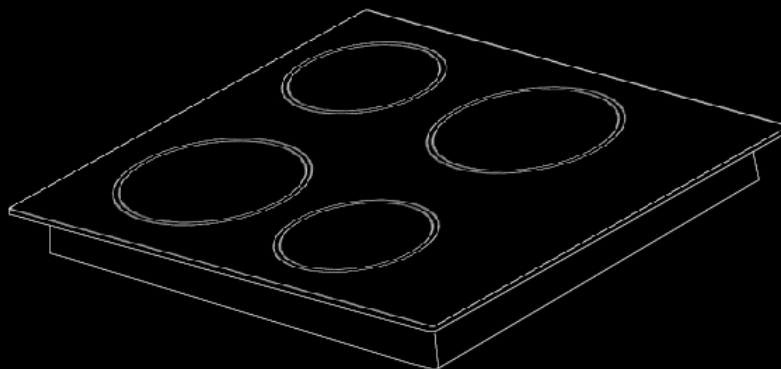

## Installation and User manual

### Content

Safety instructions-----	2
Product description-----	4
Installation-----	5
Start using your appliance-----	8
Maintenance and troubleshooting-----	13
Warranty-----	14

For warranty service call 1300 373 199(Australia)  
or 0508 123108(New Zealand) to connect you to  
the nearest authorised service centre

**BC604TG**  
**BC604TG-F**

## Safety instructions

This manual explains the proper installation and use of your appliance, please read it carefully before using even if you are familiar with the product. The manual should be kept in a safe place for future reference. In case of failure, only the Authorized Technical Service may repair this hob. Otherwise the guarantee will be null and void.

### Warning

#### General safety

- The appliance may only be installed and connected by trained, registered service engineers.
- Built-in appliances may only be used after they have been built in to suitable built-in units and work surfaces that meet standards.
- In the event of faults with the appliance or damage to the glass ceramic (cracks, scratches or splits), the appliance must be switched off and disconnected from the electrical supply, to prevent the possibility of an electric shock.
- Repairs to the appliance must only be carried out by trained registered service engineers.
- The technical and identification data for the hob figure on the reference plate fixed to the appliance.
- This reference plate must be consulted before making the electrical connections.
- The electrical connections must be made by a specialist aware of the legal and regulatory requirements in each country.
- If the cable is damaged in any way it must be replaced by the manufacturer or after sale service or by authorized technical staff, to avoid hazard.
- Power line connection: The power cord should be connected in compliance with the relevant standard, to a 3x20A omni-polar circuit breaker.
- If the appliance is being connected directly to the mains an Omni-polar circuit-breaker must be installed with a minimum opening of 3mm between contacts.

#### Correct use

- People (including children) who, because of their physical, sensory or mental capabilities or their inexperience or ignorance are not able to use the device safely, should not use this device without supervision or instruction by a responsible person.

- The appliance is not intended to be operated by means of an external timer or separate remote-control system.
- This appliance should be used only for normal domestic cooking and frying of food.
- The appliance must not be used as a work surface or as a storage surface.
- Additions or modifications to the appliance are not permitted.
- Do not place or store flammable liquids, highly inflammable materials or fusible objects (e.g. plastic film, plastic, aluminum) on or near the appliance.
- After being used for a long time, the corresponding heating zone of the ceramic hotplate is still hot. Never touch the ceramic surface to avoid burning.
- Do not heat an empty pan on the appliance.

#### Children's safety

- This appliance can be used by children aged from 8 years and above and persons with reduced physical, sensory or mental capabilities or lack of experience and knowledge if they have been given supervision or instruction concerning use of the appliance in a safe way and understand the hazards involved. Children shall not play with the appliance. Cleaning and user maintenance shall not be made by children without supervision.
- The cooking zones will become hot when you cook. Therefore, always keep small children away from the appliance.
- The appliance is not intended for use by young children or infirm persons without supervision.

- Young children should be supervised to ensure that they do not play with the appliance.
- To avoid small children and pets unintentionally switching the appliance on, we recommend activation of the child safety device.

**Safety during use**

- Remove stickers and film from the glass ceramic.
- There is the risk of burns from the appliance if used carelessly.
- Cables from electrical appliances must not touch the hot surface of the appliance or hot cookware.
- Overheated fats and oils can ignite very quickly. Warning! Fire hazard!
- Switch the cooking zones off after each use.
- Users with implanted pacemakers should keep their upper body at least 30 cm from ceramic cooking zones that are switched on.
- Risk of burns! Do not place objects made of metal, such as knives, forks, spoons and saucepan lids on the cooking surface, as they can get hot.



**Safety when cleaning**

- For cleaning, the appliance must be switched off and cooled down.
- For safety reasons, the cleaning of the appliance with steam jet or high pressure cleaning equipment is not permitted.

**How to avoid damage to the appliance**

- The glass ceramic can be damaged by objects falling onto it.
- The edge of the glass ceramic can be damaged by being knocked by the cookware.
- Cookware made of cast iron, cast aluminum or with damaged bottoms can scratch the glass ceramic if pushed across the surface.
- Objects that melt and things that boil over can burn onto the glass ceramic and should be removed straightaway.
- Do not use the cooking zones with empty cookware or without cookware.
- To avoid damaging cookware and glass ceramics, do not allow saucepans or frying pans to boil dry.
- The ventilation gap of 5mm between the worktop and front of the unit underneath it must not be covered.



DISPOSAL: Do not dispose this product as unsorted municipal waste. Collection of such waste separately for special treatment is necessary.

By ensuring that this appliance is disposed of correctly, you will help prevent any possible damage to the environment and to human health, which might otherwise be caused if it were disposed of in the wrong way.

The symbol indicates that it may not be treated as normal household waste. It should be taken to a collection point for the recycling of electrical and electronic goods.

This appliance requires specialist waste disposal. For further information regarding the treatment, recover and recycling of this product please contact your local council, your household waste disposal service, or the shop where you purchased it.

For more detailed information about treatment, recovery and recycling of this product, please contact your local city office, your household waste disposal service or the shop where you purchased the product.

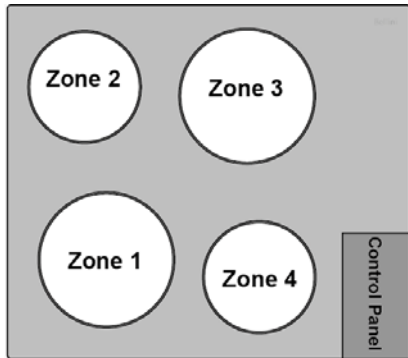

## Product description

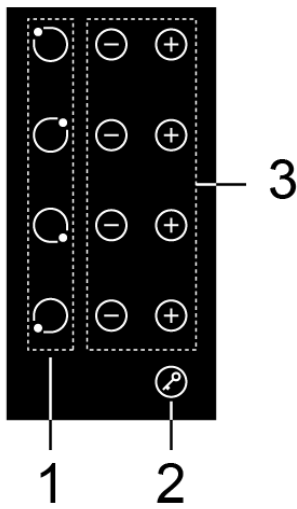

- 1. max. 1800 W zone
- 2. max. 1200 W zone
- 3. max. 1800 W zone
- 4. max. 1200 W zone



- 1. Zone choosing key
- 2. Child lock
- 3. Power level control

Accessory Name	Picture ( for reference only, physical unit maybe different)	Quantity
User Manual		1
Fixing Bracket		4
Screw M 4x10		4

## Technical Specifications

Product Dimensions (h x w x d) mm	Approx. Net Weight	Electrical Connection	Rated Input Power	Power Level
55x590x520	8.6Kg	220-240V~ 400V 3N~ 50/60Hz	5500-6600W 6000W	9

# Installation

- **Selection of installation equipment**

- Cut out the work surface according to the sizes shown in the drawing.
- For the purpose of installation and use, a minimum of 50mm space shall be preserved around the hole.
- Be sure the thickness of the work surface is at least 30mm. Please select heat-resistant work surface material to avoid larger deformation caused by the heat radiation from the hotplate. As shown below:

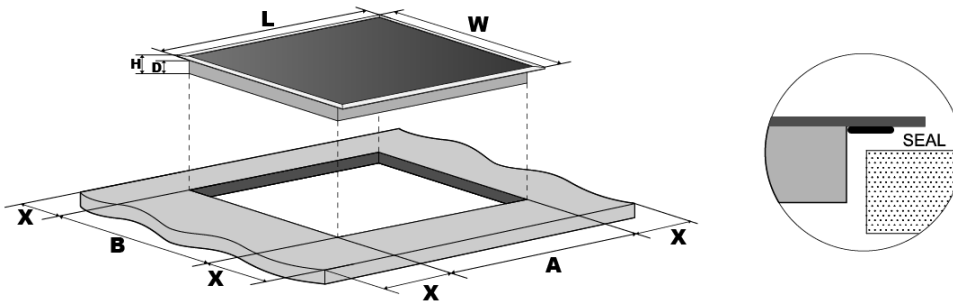

L(mm)	W(mm)	H(mm)	D(mm)	A(mm)	B(mm)	X(mm)
590	520	55	51	560+4 +1	490 +4 +1	50 mini

Under any circumstances, make sure the ceramic cooker hob is well ventilated and the air inlet and outlet are not blocked. Ensure the ceramic cooker hob is in good work state. As shown below



Note: The safety distance between the hotplate and the cupboard above the hotplate should be at least 760mm.

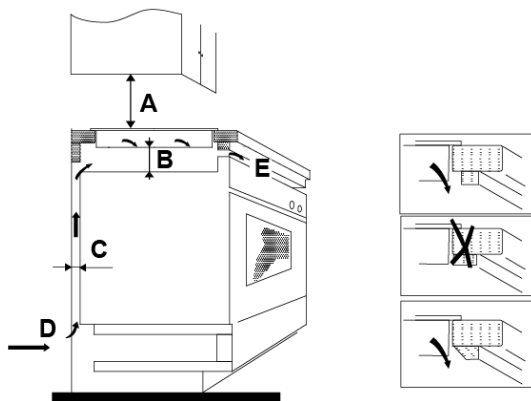

A(mm)	B(mm)	C(mm)	D	E
760	50 mini	20 mini	Air intake	Air exit 5mm

- **Before locating the fixing brackets**

- The unit should be placed on a stable, smooth surface (use the packaging). Do not apply force onto the controls protruding from the hob.
- Fix the hob on the work surface by screw four brackets on the bottom of hob (see picture) after installation.

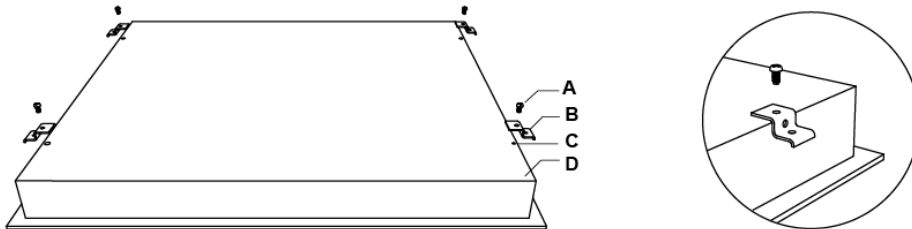

A	B	C	D
screw	bracket	Screw hole	base

Adjust the bracket position to suit for different work surface's thickness.

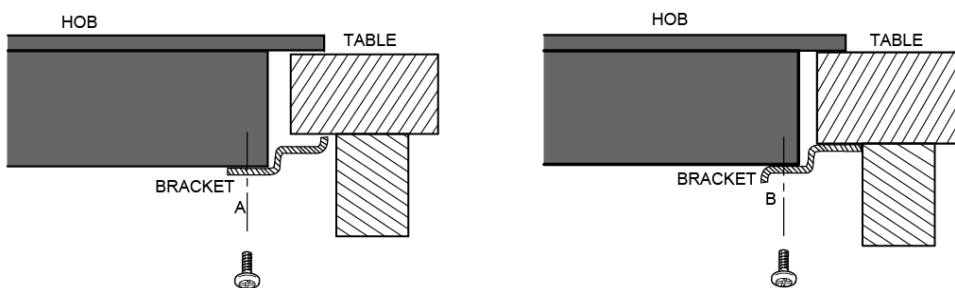

### **Cautions**

1. The ceramic cooker hob must be installed by qualified personnel or technicians. We have professionals at your service. Please never conduct the operation by yourself.
2. The ceramic cooker hob shall not be mounted to cooling equipment, dishwashers and rotary dryers.
3. The ceramic cooker hob shall be installed such that better heat radiation can be ensured to enhance its reliability.
4. The wall and induced heating zone above the work surface shall withstand heat.
5. To avoid any damage, the sandwich layer and adhesive must be resistant to heat.
6. A steam cleaner is not to be used.

### **Connecting the hob to the mains power supply**



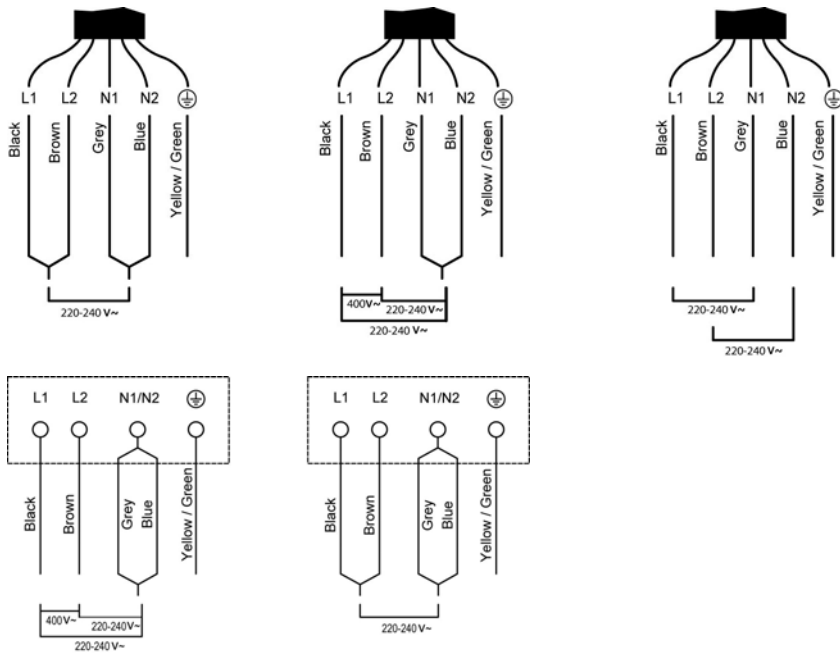

The power supply should be connected in compliance with the relevant standard, or a single-pole circuit breaker. the method of connection is shown below.

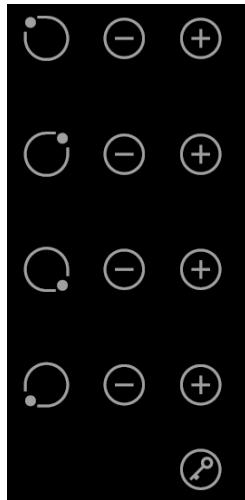

1. If the cable is damaged or needs replacing, this should be done by an after-sales technician using the proper tools, so as to avoid any accidents.
2. If the appliance is being connected directly to the mains supply, an omnipolar circuit breaker must be installed with a minimum gap of 3mm between the contacts.
3. The installer must ensure that the correct electrical connection has been made and that it complies with safety regulations.
4. The cable must not be bent or compressed.
5. The cable must be checked regularly and only replaced by a properly qualified person.

## Start using your appliance



Description	Explanation
 <p>Control to Increase/decrease power</p>	<p>Power setting of the zones, from 0 to 9, for example, this display shows power selected at level 5</p> 
 <p>Child lock</p>	<p>Touch it to lock keys(display show “Lo”) and press and hold for a while to unlock. When it is activated, none of the other buttons can be activated except for On/Off.</p>
 <p>Zone ON/OFF</p>	<p>Turn on/off the corresponding zone. You will see “0” display above power setting when turn on the appliance then you can use +/- to adjust its power level.</p>
 <p>Residual heat indicator</p>	<p>An H lights up on the power display to indicate that a particular zone is very hot and should not be touched. It may remain on up to approximately 30 minutes. Depending on the power setting selected.</p>



## Start cooking

1. Power on the unit

After power on, the buzzer beeps once, all the indicators light up for 1 second then go out, indicating that the ceramic hob has entered the state of standby mode.

2. Place a suitable pan on the cooking zone that you wish to use.

Make sure the bottom of the pan and the surface of the cooking zone are clean and dry.

3. Select a zone by touching the ON/OFF and then +/- to adjust power.

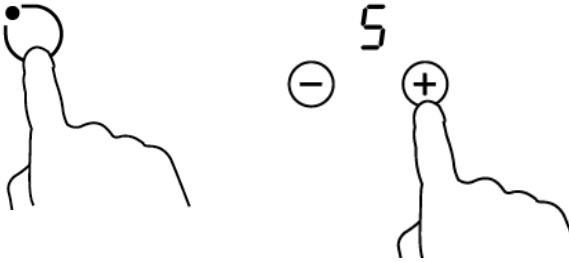

If you don't choose a heat setting within 1 minute, the ceramic hob will automatically switch off. You will need to start again at step 1.

You can modify the heat setting at any time during cooking.

## When you have finished cooking

- 1a. Turn the cooking zone off by touching "-" to level 0 or touch + and - together.

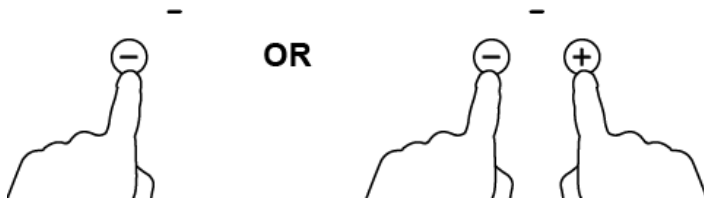

- 1b. Turn the whole cooktop off by touching the ON/OFF control.

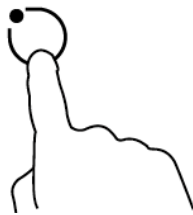

2. Beware of hot surfaces

H will show which cooking zone is hot to touch. It will disappear when the surface has cooled down to a safe temperature. It can also be used as an energy saving function if you want to pre-heat further pans, use the hotplate that is still hot.

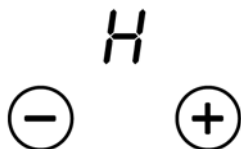

## Locking the Controls

- You can lock the controls to prevent unintended use (for example children accidentally turning the cooking zones on).
- When the controls are locked, all the controls except for the ON/OFF keys are disabled.

### To lock

Touch the child lock key. The indicator next to the key will light up



### To unlock

1. Make sure the ceramic hob is turned on.
2. Touch and hold the child lock key for a while.
3. You can now start using your ceramic hob.



When the hob is in the lock mode, all the controls are disabled except for the ON/OFF, you can always turn the ceramic hob off with the ON/OFF control in an emergency, but you shall unlock the hob first in the next operation

## Over-Temperature Protection

A temperature sensor equipped can monitor the temperature inside the ceramic hob. When an excessive temperature is monitored, the ceramic hob will stop operation automatically.

## Residual Heat Warning

When the hob has been operating for some time, there will be some residual heat. The letter “H” appears to warn you to keep away from it.

## Auto Shutdown

Another safety feature of the hob is auto shutdown. This occurs whenever you forget to switch off a cooking zone. The default shutdown times are shown in the table below:

<b>Power level</b>	1	2	3	4	5	6	7	8	9
<b>Default working timer (hour)</b>	8	8	8	4	4	4	2	2	2

## **Cooking tips:**

<b>Heat setting</b>	<b>Suitability</b>
1 - 2	<ul style="list-style-type: none"><li>• delicate warming for small amounts of food</li><li>• melting chocolate, butter, and foods that burn quickly</li><li>• gentle simmering</li><li>• slow warming</li></ul>
3 - 4	<ul style="list-style-type: none"><li>• reheating</li><li>• rapid simmering</li><li>• cooking rice</li></ul>
5 - 6	<ul style="list-style-type: none"><li>• pancakes</li></ul>
7 - 8	<ul style="list-style-type: none"><li>• sautéing</li><li>• cooking pasta</li></ul>
9	<ul style="list-style-type: none"><li>• stir-frying</li><li>• searing</li><li>• bringing soup to the boil</li><li>• boiling water</li></ul>

When food comes to the boil, reduce the temperature setting.

- Using a lid will reduce cooking times and save energy by retaining the heat.
- Minimize the amount of liquid or fat to reduce cooking times.
- Start cooking on a high setting and reduce the setting when the food has heated through.

### **Simmering, cooking rice**

- Simmering occurs below boiling point, at around 85°C, when bubbles are just rising occasionally to the surface of the cooking liquid. It is the key to delicious soups and tender stews because the flavours develop without overcooking the food. You should also cook egg-based and flourthickened sauces below boiling point.
- Some tasks, including cooking rice by the absorption method, may require a setting higher than the lowest setting to ensure the food is cooked properly in the time recommended.

### **Searing steak**

To cook juicy flavoursome steaks:

1. Stand the meat at room temperature for about 20 minutes before cooking.
2. Heat up a heavy-based frying pan.
3. Brush both sides of the steak with oil. Drizzle a small amount of oil into the hot pan and then lower the meat onto the hot pan.
4. Turn the steak only once during cooking. The exact cooking time will depend on the thickness of the steak and how cooked you want it. Times may vary from about 2 – 8 minutes per side. Press the steak to gauge how cooked it is – the firmer it feels the more 'well done' it will be.
5. Leave the steak to rest on a warm plate for a few minutes to allow it to relax and become tender before serving.

### **For stir-frying**

1. Choose an ceramic compatible flat-based wok or a large frying pan.
2. Have all the ingredients and equipment ready. Stir-frying should be quick. If cooking large quantities, cook the food in several smaller batches.
3. Preheat the pan briefly and add two tablespoons of oil.
4. Cook any meat first, put it aside and keep warm.
5. Stir-fry the vegetables. When they are hot but still crisp, turn the cooking zone to a lower setting, return the meat to the pan and add your sauce.
6. Stir the ingredients gently to make sure they are heated through.
7. Serve immediately.

## Choosing the right Cookware

Do not use cookware with jagged edges or a curved base.



Make sure that the base of your pan is smooth, sits flat against the glass, and is the same size as the cooking zone. Always centre your pan on the cooking zone.

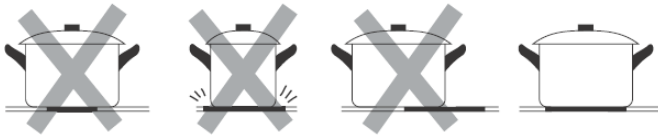

Always lift pans off the ceramic hob – do not slide, or they may scratch the glass.

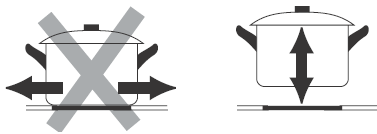

# Maintenance & Troubleshooting

## Caution:

Before maintenance or cleaning is carried out, the range hood should be disconnected from the main power supply. Ensure that the range hood is switched off at the wall socket and the plug removed.

- Spills and splashes will not harden and stick to the glass, as it hardly heats up.
- Both Vitro-ceramic and zone rings should however be cleaned of any spills or splashes as quickly as possible.
- Slight stains can be removed with kitchen paper or cloth. Do not use steam clearer.
- More resistant stains will need specific product for vitro-ceramic glass. Follow each product's instructions.

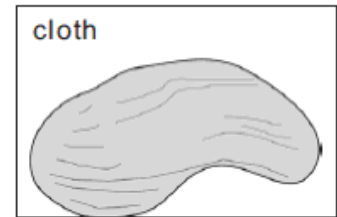
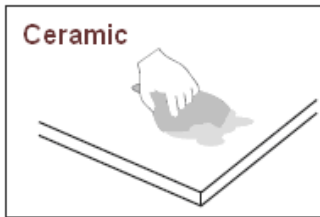

What?	How?	Important!
Everyday soiling on glass (fingerprints, marks, stains left by food or non-sugary spillovers on the glass)	<ol style="list-style-type: none"> <li>1. Switch the power to the cooktop off.</li> <li>2. Apply a cooktop cleaner while the glass is still warm (but not hot!)</li> <li>3. Rinse and wipe dry with a clean cloth or paper towel.</li> <li>4. Switch the power to the cooktop back on.</li> </ol>	<ul style="list-style-type: none"> <li>● When the power to the cooktop is switched off, there will be no 'hot surface' indication but the cooking zone may still be hot! Take extreme care.</li> <li>● Heavy-duty scourers, some nylon scourers and harsh/abrasive cleaning agents may scratch the glass. Always read the label to check if your cleaner or scourer is suitable.</li> <li>● Never leave cleaning residue on the cooktop: the glass may become stained.</li> </ul>
Boilovers, melts, and hot sugary spills on the glass	<p>Remove these immediately with a fish slice, palette knife or razor blade scraper suitable for ceramic glass cooktop, but beware of hot cooking zone surfaces:</p> <ol style="list-style-type: none"> <li>1. Switch the power to the cooktop off at the wall.</li> <li>2. Hold the blade or utensil at a 30° angle and scrape the soiling or spill to a cool area of the cooktop.</li> <li>3. Clean the soiling or spill up with a dish cloth or paper towel.</li> <li>4. Follow steps 2 to 4 of 'Everyday soiling on glass' above.</li> </ol>	<ul style="list-style-type: none"> <li>● Remove stains left by melts and sugary food or spillovers as soon as possible. If left to cool on the glass, they may be difficult to remove or even permanently damage the glass surface.</li> <li>● Cut hazard: when the safety cover is retracted, the blade in a scraper is razor-sharp. Use with extreme care and always store safely and out of reach of children.</li> </ul>
Spillovers on the touch controls	<ol style="list-style-type: none"> <li>1. Switch the power to the cooktop off.</li> <li>2. Soak up the spill</li> <li>3. Wipe the touch control area with a clean damp sponge or cloth.</li> <li>4. Wipe the area completely dry</li> <li>5. with a paper towel.</li> <li>6. Switch the power to the cooktop back on.</li> </ol>	<p>The cooktop may beep and turn itself off, and the touch controls may not function while there is liquid on them. Make sure you wipe the touch control area dry before turning the cooktop back on.</p>

## WARRANTY

- 1.1 In this warranty:
  - 1.1.1 Australian Consumer Law means the law as set out in Schedule 2 of the Competition and Consumer Act 2010;
  - 1.1.2 **Company** means GSM Sales Pty Ltd ABN 53 007 682 475 of 142-144 Fullarton Road, Rose Park SA 5067. Telephone 08 8122 2390. Email [admin@gsm-sales.com.au](mailto:admin@gsm-sales.com.au);
  - 1.1.3 **Consumer** means a “consumer” as that term is defined in Section 3 of the Australian Consumer Law as the original purchaser of a Bellini product;
  - 1.1.4 **Consumer Guarantees** means the guarantees under the Australian Consumer Law;
  - 1.1.5 **You** means the Consumer.
- 1.2 Nothing in this warranty affects any person’s rights under the Australian Consumer Law. The benefits to any Consumer under this warranty are in addition to the rights and remedies available under any Consumer Guarantees.
- 1.3 Subject to the other clauses of this warranty, the Company warrants to the Consumer that the Bellini product will be free of manufacturing defects and will perform to the Company’s specifications.
- 1.4 The benefit of this warranty extends only to the Consumer as original purchaser of a Bellini product which is installed in a residential property.
- 1.5 This warranty commences on the date of purchase of the Bellini product by the Consumer and continues for the benefit only of the Consumer until the expiry of two (2) year **(Warranty Period)**.
- 1.6 If within the Warranty Period a manufacturing defect is discovered in the Bellini product or it fails to perform to the Company’s specifications as a result of some defect in materials, components or workmanship (Defect) then the Company will, at its option, repair the Bellini product or supply a replacement Bellini product free of charge. A replacement Bellini product may differ from the original product purchased by the Consumer.
- 1.7 This warranty will not apply to any Bellini product:
  - 1.7.1 Installed by any person other than a qualified tradesperson; or
  - 1.7.2 Subjected to misuse, neglect, negligence or accidental damage; or
  - 1.7.3 Operated in any way contrary to any operating or maintenance instructions; or
  - 1.7.4 Improperly handled, installed or maintained; or
  - 1.7.5 Altered or modified prior to or after installation; or
  - 1.7.6 Damaged directly or indirectly by power surges, electrical storm damage or connection to incorrect power supply

The Australian Consumer Law requires the inclusion of the following statement  
with this warranty:

***Our goods come with guaranteed that cannot be excluded under the Australian Consumer Law. You are entitled to a replacement or refund for a major failure and for compensation for any other reasonably foreseeable loss or damage. You are also entitled to have the goods repaired or replaced if the goods fail to be of acceptable quality and the failure does not amount to a major failure.***

**IN ORDER TO MAKE A CLAIM UNDER THIS WARRANTY THE  
CONSUMER MUST CALL 1300 373 199 (AUSTRALIA) OR 0508 123 108  
(NEW ZEALAND) TO CONNECT TO THE NEAREST AUTHORISED CENTRE**

- 1.8 You must provide proof of your purchase of the Bellini product and the date of purchase in order to obtain the benefit of this warranty.
- 1.9 If you live outside the service area of the Company or one of its service agents, this warranty does not cover the cost of transport of the Bellini product for service nor the service agent's traveling costs to and from your home.
- 1.10 If you are required to transport the Bellini product to the Company or its service agent, you must ensure it is safely disconnected by a qualified tradesman and securely packed and insured. The Company does not accept any responsibility for loss or damage of the Bellini product prior to it being received by the Company or its service agent.
- 1.11 You will be responsible for all costs of returning a Bellini product to the Company and for redelivery of the Bellini product by the Company (whether it is the original or a repaired and/or a replacement Bellini product) and for any other expenses you incur in claiming under this warranty.
- 1.12 The Company or its service agent will examine any Bellini product and if the Company determines that it is defective through no fault of the Owner and is otherwise undamaged, the Company will repair or replace the Bellini product in accordance with this warranty.

**DO NOT SEND IN THIS WARRANTY**

Fill out the following details and file with your purchase invoice.

**RETAIN & FILE WITH YOUR RECEIPT**

Your Purchase Receipt/Invoice is proof of date of purchase. If you are unable to establish the date of purchase, or if the fault is not covered by this warranty, or if the product is found to be in working order, you will be required to bear all service call charges.

GSM Sales Pty Ltd reserves the right to discontinue items, modify designs and change specifications without incurring obligation.

Whilst every effort is made to ensure that descriptions, specifications and other information in this publication is correct, no warranty is given in respect thereof and the company shall not be liable for any errors therein.

Purchased from:

Co. Name:

Address:

Date of Purchase:

Serial number:

NOTE: Consistent with our continuing product development policy, improvements may have been made which render the contents of this packaging slightly different to that shown.

**FOR WARRANTY SERVICE CALL 1300 373 199 (AUSTRALIA)  
OR 0508 123 108 (NEW ZEALAND) TO CONNECT YOU TO THE NEAREST  
AUTHORISED SERVICE CENTRE**

