

**clarion®**

5.8" TFT MOTORIZED LCD MONITOR  
Moniteur LCD assisté TFT de 5,8"  
MONITOR DE CRISTAL LÍQUIDO TFT MOTORIZADO DE 5,8"

# VMA7483

Owner's manual  
Mode d'emploi  
Manual de instrucciones

English

Français

Español

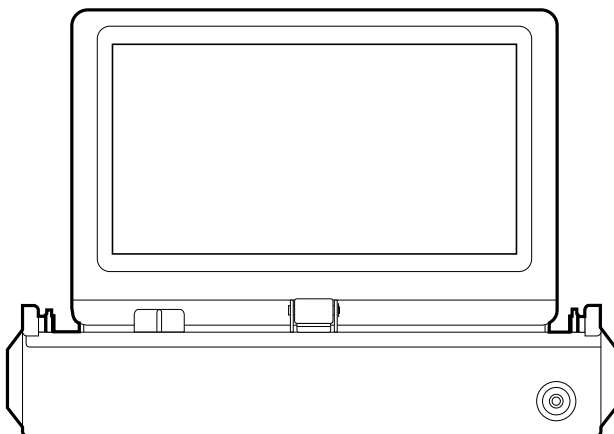

*Thank you for purchasing the **Clarion VMA7483.**  
Nous vous remercions d'avoir acheté le **Clarion VMA7483.**  
Muchas gracias por la adquisición del **VMA7483 Clarion.***

**English**

- \* Please read this owner's manual in its entirety before operating this equipment.
- \* After reading this manual, be sure to keep it in a handy place (e.g., glove compartment).  
If you sell the motor vehicle, please leave the manual in it so that the new owner can use it.
- \* Read the contents of the enclosed warranty card and keep it with this manual.

**Français**

- \* Lisez tout le mode d'emploi avant de mettre l'appareil en service.
- \* Après avoir lu ce mode d'emploi, prenez soin de le conserver dans un endroit pratique (par ex: la boîte à gants).  
Si vous vendez votre véhicule à moteur, laissez-y le manuel de façon que le nouveau propriétaire puisse l'utiliser.
- \* Lisez le contenu de la carte de garantie comprise et conservez-la avec ce manuel.

**Français****■ Table des matières**

<b>1. PRÉCAUTIONS</b> .....	19
Précautions de manipulation .....	21
Nettoyage .....	21
Télécommande .....	22
A des fins de sécurité routière .....	22
Précautions d'utilisation .....	22
<b>2. CARACTÉRISTIQUES</b> .....	23
<b>3. CONTENU DE L'EMBALLAGE</b> .....	23
<b>4. NOM DES PIÈCES ET LEURS FONCTIONS</b> .....	24
Appareil principal (lorsque l'écran LCD est allumé) .....	24
Panneau arrière .....	25
Réglage du sélecteur d'image .....	25
Télécommande .....	26
<b>5. OPÉRATIONS</b> .....	28
Ouverture et fermeture de l'écran LCD .....	28
Sélection du mode d'écran (taille) .....	30
Configuration .....	31
<b>6. DÉPANNAGE</b> .....	33
<b>7. SPÉCIFICATIONS</b> .....	34
Appareil principal .....	34
Télécommande (télécommande sans fil à infrarouge à 14 touches) .....	34

**Español**

- \* Antes de utilizar el equipo, lea completamente este Manual de instrucciones.
- \* Después de haber leído este manual, guárdelo a mano (p. ej., en la guantera).  
Cuando venda su automóvil, deje en él el manual de instrucciones a fin de que pueda utilizarlo el nuevo usuario.
- \* Lea el contenido de la tarjeta de garantía adjunta, y guárdela con este manual.

**English****■ Contents**

<b>1. PRECAUTIONS</b> .....	3
Caution on Handling .....	5
Cleaning .....	5
Remote Control Unit .....	6
For Safe Driving .....	6
Handling Precautions .....	6
<b>2. FEATURE</b> .....	7
<b>3. PACKAGE CONTENTS</b> .....	7
<b>4. NAMES OF PARTS AND THEIR FUNCTIONS</b> .....	8
Main Unit (when the LCD panel is on) .....	8
Rear Panel .....	9
Image Select Switch Setting .....	9
Remote Control .....	10
<b>5. OPERATIONS</b> .....	12
Starting Up and Retracting the LCD Panel .....	12
Selection of the screen mode (size) .....	14
Setup .....	15
<b>6. TROUBLESHOOTING</b> .....	17
<b>7. SPECIFICATIONS</b> .....	18
Main Unit .....	18
Remote Control Unit (14 key infrared wireless remote control unit) .....	18

**Español****■ Índice**

<b>1. PRECAUCIONES</b> .....	35
Precauciones sobre el manejo .....	37
Limpieza .....	37
Unidad de control remoto .....	38
Para conducir con seguridad .....	38
Precauciones de manejo .....	38
<b>2. CARACTERÍSTICAS</b> .....	39
<b>3. CONTENIDO DEL PAQUETE</b> .....	39
<b>4. NOMBRES DE LAS PARTES Y SUS FUNCIONES</b> .....	40
Unidad principal (con el panel del cristal líquido desplegado) .....	40
Panel posterior .....	41
Ajuste del selector de imagen .....	41
Control remoto .....	42
<b>5. OPERACIONES</b> .....	44
Desplegado y replegado del panel de cristal líquido .....	44
Selección del modo (tamaño) de pantalla .....	46
Configuración .....	47
<b>6. SOLUCIÓN DE PROBLEMAS</b> .....	49
<b>7. ESPECIFICACIONES</b> .....	50
Unidad principal .....	50
Unidad de control remoto .....	50

# 1. PRECAUTIONS

1. This set is for use in DC 12V, negative ground vehicles. Be sure to consult your store of purchase or a Clarion-designated service outlet before installing it on DC 24V cars.
2. Do not operate the set in ways other than described in this guide. Doing so may damage it.
3. **Safety first! For rear seat use only. Do not install on dashboard or anywhere else that would permit monitor to be viewed by the driver.** Monitor must not be located in the motor vehicle at any point forward of the back of the front seats. Monitor must never be used in any manner that will distract driver or interfere with driver's safe operation of the motor vehicle.
4. Be careful not to run down the car battery while using the set with the car stopped.
5. For safety, install the set in a position at which it cannot be seen by the driver.
6. Do not disassemble or modify the set. Doing so may damage it.
7. Keep drinks and drops from umbrellas away from the set. Water may damage the internal circuitry.
8. Do not let lit cigarettes or other hot objects touch the set. Doing so may damage or deform the cabinet.
9. In extremely cold temperatures, the movement of the picture may be slow and the picture may be dark, but this is not a malfunction. The set will work normally once the temperature increases.
10. Small black and shiny dots inside the liquid crystal panel are normal for liquid crystal products.

This equipment has been tested and found to comply with the limits for a Class B digital device, pursuant to Part 15 of the FCC Rules. These limits are designed to provide reasonable protection against harmful interference in a residential installation. This equipment generates, uses, and can radiate radio frequency energy and, if not installed and used in accordance with the instructions, may cause harmful interference to radio communications. However, there is no guarantee that interference will not occur in a particular installation. If this equipment does cause harmful interference to radio or television reception, which can be determined by turning the equipment off and on, the user is encouraged to consult the dealer or an experienced radio/TV technician for help.

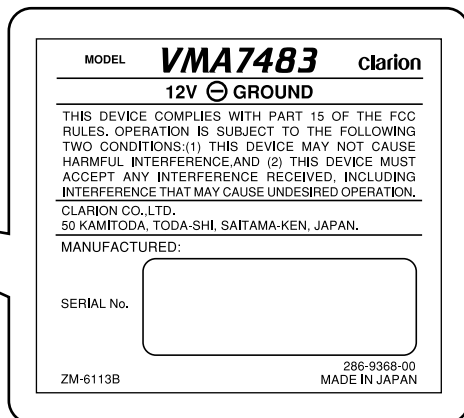
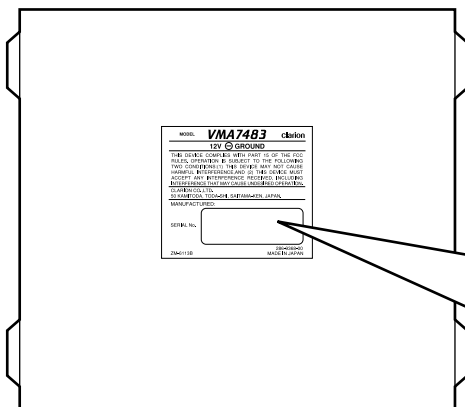

**⚠ CAUTION**

USE OF CONTROLS, ADJUSTMENTS, OR PERFORMANCE OF PROCEDURES OTHER THAN THOSE SPECIFIED HEREIN, MAY RESULT IN HAZARDOUS RADIATION EXPOSURE. THE COLOR LCD MONITOR SHOULD NOT BE ADJUSTED OR REPAIRED BY ANYONE EXCEPT PROPERLY QUALIFIED SERVICE PERSONNEL.

**INFORMATION FOR USERS:**

CHANGES OR MODIFICATIONS TO THIS PRODUCT NOT APPROVED BY THE MANUFACTURER WILL VOID THE WARRANTY AND WILL VIOLATE FCC APPROVAL.

**⚠ WARNING**

MONITOR AND TUNER MUST BE INSTALLED AND USED ONLY IN ACCORDANCE WITH THESE INSTRUCTIONS. FAILURE TO DO SO MAY CAUSE DAMAGE TO THE VEHICLE OR THE MONITOR, MAY RESULT IN AN ACCIDENT, AND MAY VIOLATE THE LAW. CLARION DISCLAIMS ANY LIABILITY FOR ANY DAMAGES THAT MAY RESULT FROM A FAILURE TO INSTALL AND USE THIS UNIT AS STATED IN THESE INSTRUCTIONS.

## Caution on Handling

---

For a longer service life, be sure to read the following cautions.

1. Do not expose the LCD panel to pressure when it is on as this may cause damage, deformation or other failures.
2. The LCD panel must be retracted inside the unit, when the vehicle is to be parked outside for long periods of time. (The LCD panel operates normally within a temperature range of 0°C to 60°C.)
3. The LCD panel surface is easily marred. Do not scratch or hit it with hard objects.
4. Any moisture or condensation that is formed on the LCD panel must be wiped away immediately using cotton wool or a soft cloth. Failure to do so could lead to discoloration and stains and any water that enters the unit could lead to failure.

## Cleaning

---

### • Cleaning the cabinet

Use a soft, dry cloth and gently wipe off the dirt.

For tough dirt, apply some neutral detergent diluted in water to a soft cloth, wipe off the dirt gently, then wipe again with a dry cloth.

Do not use benzine, thinner, car cleaner, etc., as these substances may damage the cabinet or cause the paint to peel. Also, leaving rubber or plastic products in contact with the cabinet for long periods of time may cause stains.

### • Cleaning the LCD panel

The LCD panel tends to collect dust, so wipe it off occasionally with a soft and dry cloth.

The surface is easily scratched, so do not rub it with hard objects.

## Remote Control Unit

1. The remote control unit may fail to operate when the remote control receiver sensor is exposed to direct sunlight. Should this happen, block the path of the sunlight before using the remote control unit.
2. Replace the batteries in the remote control unit when its operating range and angle of operation start to decrease.
3. Do not leave the remote control unit in a location where it is exposed to high temperatures as this may cause failure or deformation.

## For Safe Driving

For the sake of safe driving, a video image is displayed only when the car is parked (and the hand brake has been engaged). Stop the car when you intend to watch a video. (The screen shown below is displayed while driving.)



Image displayed while driving

## Handling Precautions

Observe the instructions listed below in installing the unit as incorrect installation may render the LCD inoperable or cause a breakdown.

1. The unit must be installed horizontally.
2. Do not place objects on the unit when the LCD panel is retracted.
3. Observe the following instructions when installing a decorative case on the unit.
  - The case must not interfere with the LCD panel when it is opened or retracted.
  - The case must not interfere with the operation of the LCD panel lock lever.
  - The case must not interfere with the operation of the LCD panel lock button.

## 2. FEATURE

### ■ 5.8" color LCD panel

Equipped with a 5.8" TFT active matrix color LCD panel, the unit provides realistic, vivid reproduction of video images.

### ■ Function for flipping the image vertically

The Image Select switch allows you to flip the image vertically to allow installation of the unit in the ceiling or in a console box.

## 3. PACKAGE CONTENTS

- VMA7483 ..... 1
- Remote control unit (RCB-130-103) ..... 1
- Remote control sensor ..... 1
- Connecting cable ..... 1

# 4. NAMES OF PARTS AND THEIR FUNCTIONS

## Main Unit (when the LCD panel is on)

### LCD panel lock button

Locks the LCD panel in its retracted state.

The LCD panel OPEN/CLOSE button does not operate when the lock button is engaged.

### LCD panel lock lever

### Remote control sensor

### LCD panel OPEN/CLOSE button

### Remote control signal infrared eye

### LCD panel

Use the installation bracket and secure it to a console box or the like.

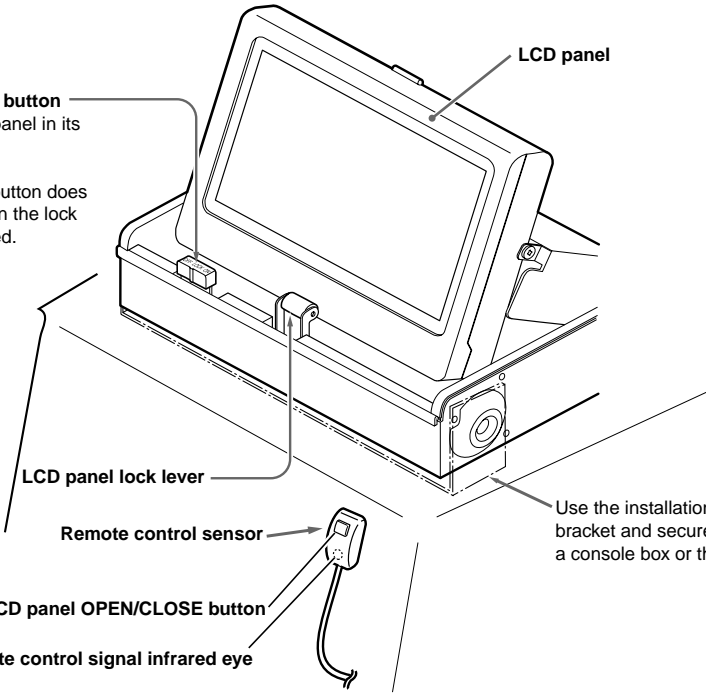



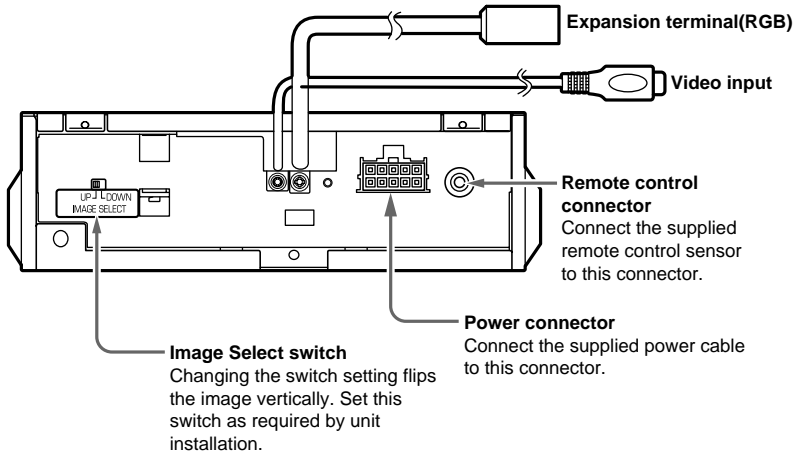

## Image Select Switch Setting

Observe the following instruction in installing the unit.

**Note:**

The unit must be installed horizontally.

### ● Console box installation

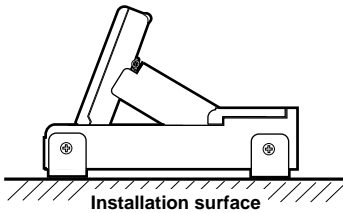

Set the Image Select switch to position "UP".



### ● Ceiling installation

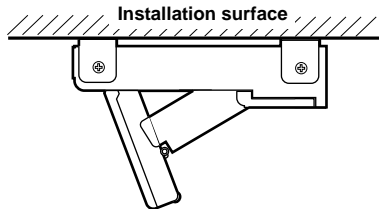

Set the Image Select switch to position "DOWN".



## ● Remote control sensor

### LCD panel OPEN/CLOSE button

- Hold down this button for 1 second to start up the LCD panel.  
The LCD panel is retracted when the button is held down a second time.
- Pressing this switch while the display is on switches the unit between video and RGB display.

Remote control signal infrared eye.

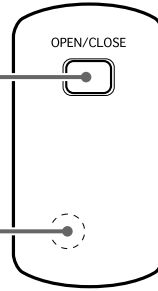

## ● Remote control unit (RCB-130)



**PWR Power button**  
Turns the power on and off.



**Adjusting buttons**  
Adjust BRIGHT/HUE/COLOR.



**AUTO/TIME button**  
• Press this button to display the LCD panel auto startup screen.  
• Hold down this button for 2 seconds to display the LCD panel retraction delay setup screen.



**Setup buttons (1 to 5)**  
• Use to select ON or OFF when the LCD panel auto startup screen is displayed.  
• Set the retraction delay (1 to 5 seconds) when the LCD panel retraction delay setup screen is displayed.



**RTN Set button (RTN)**  
This button is used to complete settings in the setup screen.

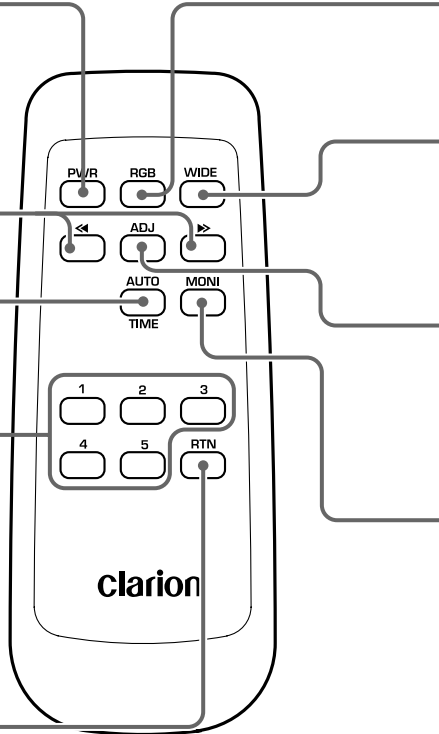

## ● Remote control operation

Aim the remote control unit at the remote control sensor (supplied) within a 30° horizontal and vertical angle.

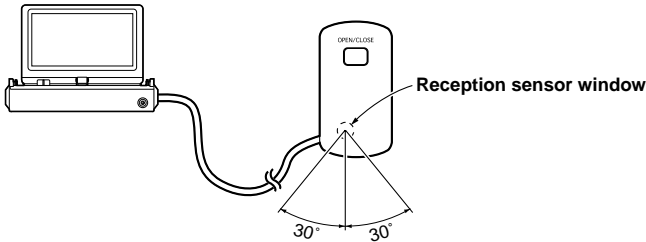

### RGB RGB button



Switches between video and RGB display.

### WIDE WIDE button



Each time this button is pressed, the display changes in the following order: NORMAL → WIDE → F.WIDE → CINEMA → NORMAL.

### ADJ Adjust button



Displays the image adjustment screen and allows you to select BRIGHT, HUE or COLOR.

### MONI MONITOR button



Turns the monitor screen on and off.

## Inserting the Batteries

1. Turn the remote control unit over, then slide the rear cover in the direction of the arrow.
2. Insert the AA (UM-3/1.5V) batteries that came with the remote control unit facing in the directions shown in the figure, then close the rear cover.

### Notes:

Using batteries improperly can cause them to explode. Take note of the following points:

- When replacing batteries, replace both batteries with new ones.
- Do not short-circuit, disassemble or heat batteries.
- Do not dispose of batteries into fire or water.
- Dispose of spent batteries properly.

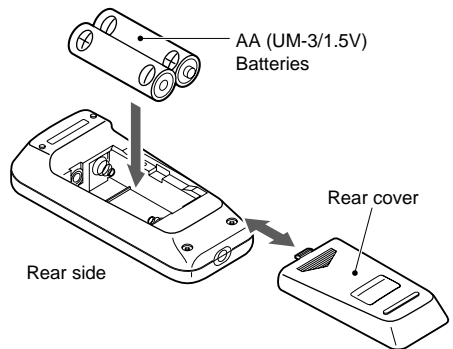

# 5. OPERATIONS

## Starting Up and Retracting the LCD Panel

### ⚠ WARNING

To prevent battery depletion, operate the unit with the engine on.

### Notes

- The angle of the LCD panel cannot be adjusted. Attempts to adjust the angle could damage the unit.
- When the LCD panel stops half-way out, press the LCD panel OPEN/CLOSE button to retract it. Then press it once again to open it.
- Check for any object that maybe in the way before trying to re-open panel.
- Do not move the LCD panel Lock button to the "LOCK ON" position when the LCD panel is open as the LCD panel and the LCD panel lock lever will interfere with each other when the panel is retracted, which could damage the unit.

### ⚠ CAUTION

Be sure not to get your fingers caught between the LCD panel and the unit or the instrument panel.

### Opening the LCD Panel

1. Turn the ignition key to ACC or ON.
2. Slide the LCD panel lock button to "LOCK OFF".

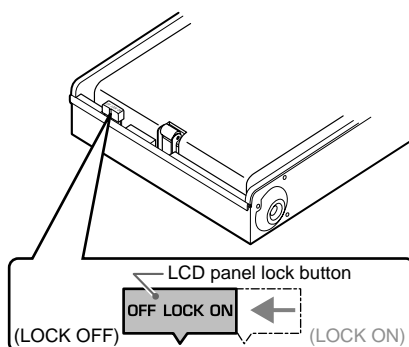

### Note:

The LCD panel cannot be opened when the LCD panel lock button is in the "LOCK ON" position.

3. Hold down the LCD panel OPEN/CLOSE button on the remote control for 1 second. This action opens the LCD panel and turns it on.

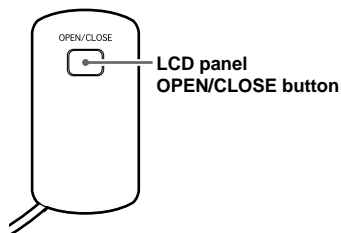

### Turning off the panel

Press the power button to turn off the panel.

## Retracting the LCD Panel

1. Make sure that the LCD panel lock button is set to "LOCK OFF".

The LCD panel OPEN/CLOSE button does not operate when this button is set to "LOCK ON".

**Note:**

- If an attempt is made to retract the LCD panel when the LCD panel lock button has not been fully set to the "LOCK OFF" position, the LCD panel and the LCD panel lock lever will interfere and damage the unit.

2. Hold down the LCD panel OPEN/CLOSE button on the remote control sensor for 1 second.

This action turns off the power and automatically retracts the LCD panel.

**Notes:**

- The LCD panel is automatically retracted when the ignition key is set to OFF.
- When the unit is not to be used for a long period of time or when you leave the car, make sure to retract the LCD panel.
- Exposing the LCD panel to force when it is being retracted will damage it.

3. Switch the LCD panel lock button to the "LOCK ON" position when the LCD panel has been retracted.

## Precautions to Be Taken When Driving on Bad Roads

When driving on bad roads such as dirt roads or in a desert, retract the LCD panel and slide the LCD panel lock button to "LOCK ON" to protect the LCD panel.

Note that the button must be in the "LOCK ON" position when the unit is installed in the ceiling of a car.

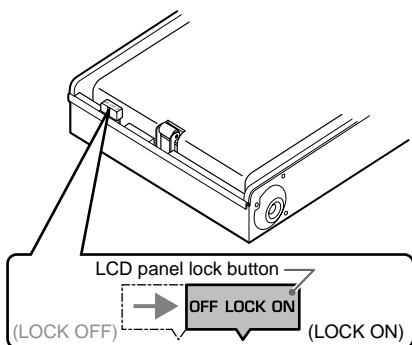
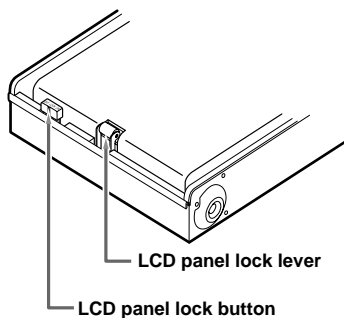

## Selection of the screen mode (size)

The following screen display modes are supported: normal, full wide, wide and cinema.

### Notes:

- Various screen display modes are available on this monitor.  
If you select the screen display mode which is different from the image ratio of software, such as a TV program, it differs in appearance from the original image. Please keep this in mind and select the appropriate screen display mode.
- If you reduce or enlarge an image using the screen display mode switching function (full wide, cinema, etc.) of this monitor with profit in mind or for any purpose of making the public watch it or listen to it, it may infringe the rights of the author who is protected under the copyright law.

### Selecting a screen display mode

Pressing the WIDE button switches the screen display mode as follows: NORMAL→WIDE→F•WIDE→CINEMA→NORMAL→

※ The screen display mode can be set for each video source.

#### ●Normal mode

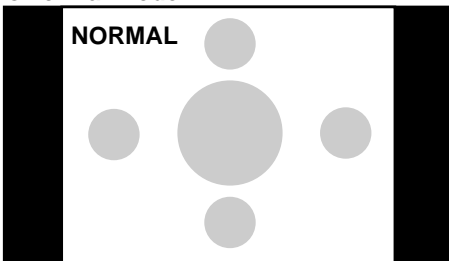

Picture of a normal TV program (4:3)

#### ●Wide mode

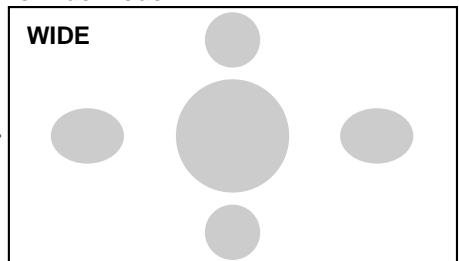

This mode enlarges a normal picture only horizontally and fully to the screen edges.

(This enlarges the picture in a small area in the center, and in a large area in the proximity of the right and left side of the screen. This enlarges the picture in a natural manner with a lesser feeling of being out of harmony.)

#### ●Cinema mode

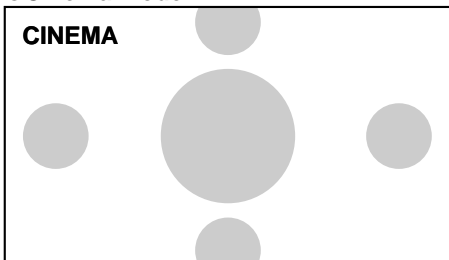

This mode enlarges a normal picture in all, and allows you to enjoy the picture in a larger size.

However, the upper and lower parts of the picture, or the right and left parts of the picture will be missed.

#### ●Full wide mode

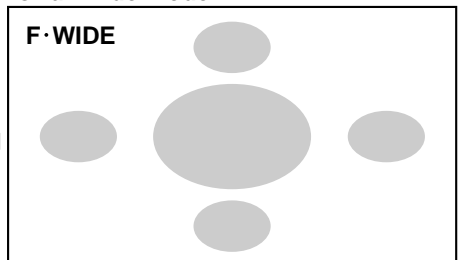

This mode enlarges a picture only horizontally and fully to the screen edges in a balanced manner.

\* The operations on this page are performed with the remote control unit.

## Setting Automatic LCD Panel Startup

This function starts the LCD panel automatically when the ignition key is moved to ACC.

\* The default setting is "OFF".

### Note:

This function is not available while driving or when an RGB screen is displayed.

1. Press the AUTO/TIME button to display the AUTO selection screen.

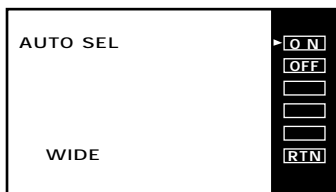

2. Press the setup button (1) to select "ON". The ► mark is displayed to the left of "ON".

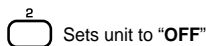
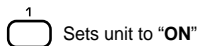

### Noes:

- When the setup button is in the "ON" position, the LCD panel is automatically started up when the ignition key is moved to ACC .
- The LCD panel can be opened and retracted using the LCD panel OPEN/CLOSE button when the setup button is set to "ON".
- Set the setup button to "OFF" when you wish to cancel this function.

3. The previous screen is displayed by pressing the set button (RTN).

## Setting LCD Retraction Delay

To protect the LCD panel, it is automatically retracted when the engine is turned off or the ignition key is moved to the ACC OFF position. It is possible to set a retraction delay between engine turn off and start of LCD retraction.

- The default setting is 5 seconds.
- This setting is designed to prevent the LCD panel opened as the ignition key is moved to ACC ON from being automatically retracted when power from a weak battery is temporarily cut off and it takes longer to start the engine.
- The panel can be retracted in the normal way by pressing the LCD panel OPEN/CLOSE button also during the retraction delay interval.

### Note:

This function is not available while driving or when an RGB screen is displayed.

1. Hold down the AUTO/TIME button for 2 seconds to display the TIME selection screen.

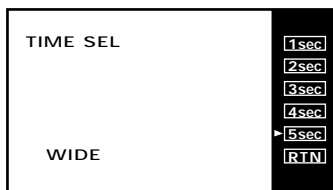

2. Use the setup buttons (1 to 5) to set the retraction delay. The ► mark is displayed to the left of the selected time.

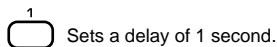

3. The previous screen is displayed by pressing the set button (RTN).

## Setup

### Adjusting screen brightness, hue and color

#### Note:

This function is not available while driving or when an RGB screen is displayed.

1. Press the adjust button (**ADJ**) to display the image adjustment screen.
2. Press the adjust button (**ADJ**) to select the item to be adjusted.
- \* Each time the adjust button (**ADJ**) is pressed, the screens are displayed in the following order: BRIGHT → HUE → COLOR → first screen.
3. Press the Adjusting buttons (**◀/▶**) to adjust.

Adjusting mode	Press ◀	Press ▶
Brightness adjustment (BRIGHT)	The image becomes darker.	The image becomes brighter.
Hue adjustment (HUE)	The image becomes redder.	The image becomes greener.
Color adjustment (COLOR)	The image becomes lighter.	The image becomes more saturated.

#### ● Brightness adjusting screen (BRIGHT)

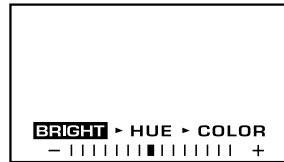

#### ● Hue adjusting screen (HUE)

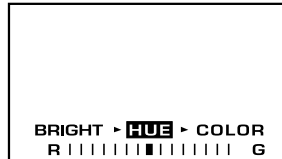

#### ● Color adjusting screen (COLOR)

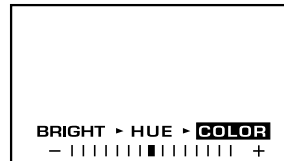



# Clarion

# VMA7483

## CONNECTING THE UNIT

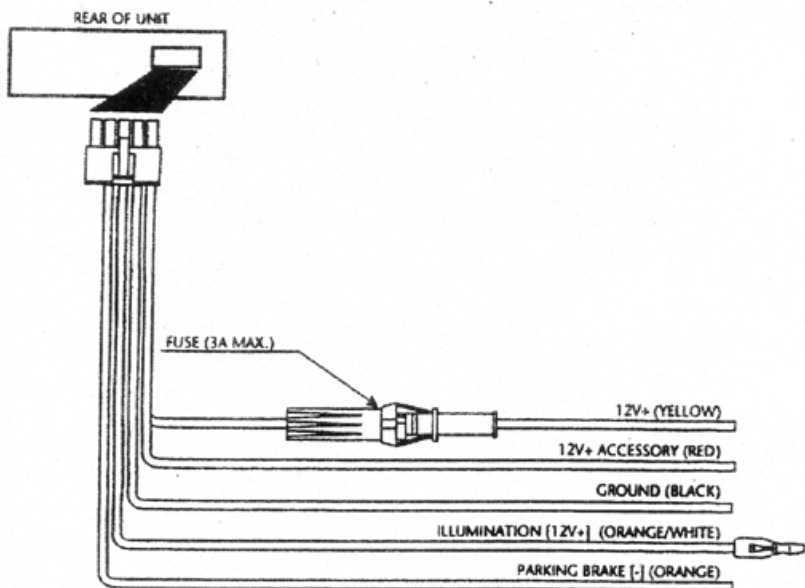

WIRE COLOR	CONNECTION
YELLOW	Connect to a constant source of power (+12V/3Amp Max)
RED	Connect to a terminal that has +12V only when the key is in the 'ON' position
BLACK	Connect to Vehicle Chassis Ground
ORANGE/WHITE	Connect to the dash light lead that has +12V when the dash lights are on
ORANGE	Connect to parking brake switch side that has ground when parking brake is engaged

# 6. TROUBLESHOOTING

Symptom	Cause	Remedy
The screen cannot be started up	Is the LCD panel lock button set to "LOCK ON"?	Set the LCD panel lock button to "LOCK OFF".
	Is the LCD panel OPEN/CLOSE button set correctly?	Hold down the LCD panel OPEN/CLOSE button for 1 second.
No image	The parking brake is not engaged.	Make sure that the parking brake is properly engaged.
	The car is being driven.	No image can be displayed while driving. Park the car to enjoy video playback (and engage the parking brake).
	The power is off.	To view a video tape, turn on the power switch and check that the video screen is displayed.
The image is too dark	The brightness is improperly adjusted.	Make sure that the brightness is properly adjusted.
	Poor operating conditions	This happens when the temperature in the car is below 0°C or above 60°C. Lower the temperature to normal (around 25°C) and check again.
	The ceiling light is on.	The screen is dark at night to prevent glare. (The screen also becomes dark in the daytime when the ceiling lights are turned on.)
The color is too faint and hue is poor	Improper color adjustment	Check whether or not the hue and color has been properly adjusted.
The LCD panel OPEN/CLOSE button is lit even when the engine is off (and the key is turned to ACC OFF).	The LCD panel OPEN/CLOSE button has been pressed.	The LCD panel OPEN/CLOSE button, when pressed, stays lit for about a second even when the engine has been turned off (and the key is set to ACC OFF position).

# 7. SPECIFICATIONS

## **Main Unit**

---

Display size	: 5.8" (width 127 mm X height 72 mm)
Display format	: transparent TN liquid crystal panel
Drive method	: TFT (thin-film transistor) Active matrix drive method
Pixels	: 280,800 pixels 234 (V) X 1200 (H)
VTR image input	: 1.0±0.2 V p-p (input impedance 75 Ω)
Power voltage	: 13.2 DC V (10.8 to 15.6 V)
Current consumption	: 1.5 A or less
Mass	: approx. 1.5 kg
External dimensions	: 191.7 (W) X 52 (H) X 165.5 (D) mm 7-9/16" (W) X 2-1/16" (H) X 6-1/2" (D)

## **Remote Control Unit** **(14 key infrared wireless remote control unit)**

---

External dimensions	: 44 (W) X 110 (H) X 27.2 (D) mm
Mass	: approx. 80 g (including batteries)

\* Specifications and design are subject to change without prior notice for the sake of product improvement.