

**Big Blue Single Stage Thermostat with Automatic Heat/Cool Changeover Option**

Single Stage Installation and Operating Instructions for Model:

Save these instructions for future use!

FAILURE TO READ AND FOLLOW ALL INSTRUCTIONS CAREFULLY BEFORE INSTALLING OR OPERATING THIS CONTROL COULD CAUSE PERSONAL INJURY AND/OR PROPERTY DAMAGE.

Model	Programming Choices		
1F97-1277	Non-Programmable	5/1/1 Day	7 Day

**APPLICATIONS**

**THERMOSTAT APPLICATION GUIDE**

Description	
Heat Pump (No Aux. or Emergency Heat)	No
Heat Pump (with Aux. or Emergency Heat)	No
Systems with up to 3 Stages Heat, 2 Stages Cool	No
Heat Only Systems	Yes
Millivolt Heat Only Systems – Floor or Wall Furnaces	Yes
Cool Only Systems	Yes
Gas or Oil Heat	Yes
Electric Furnace	Yes
Hydronic (Hot Water) Zone Heat – 2 Wires	Yes
Hydronic (Hot Water) Zone Heat – 3 Wires	Yes
Wired Remote Temperature Sensor (Indoor/Outdoor)	Yes
Dual Fuel Feature (Heat Pump Mode)	No

1F97-1277 Touchscreen Thermostat

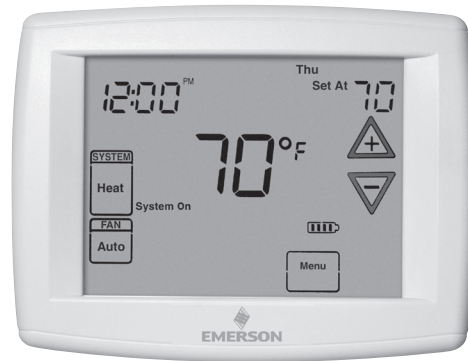

**SPECIFICATIONS**

Electrical Rating:

Battery Power	mV to 30 VAC, NEC Class II, 50/60 Hz or DC
Input-Hardwire	20 to 30 VAC
Terminal Load	1.5A per terminal, 2.5A maximum all terminals combined
Setpoint Range	45 to 99°F (7 to 37°C)
Differential (Single Stage)	Heat 0.6°F; Cool 1.2°F
Differential (Multi-Stage)	Heat 0.6°F; Cool 1.2°F
Differential (Heat Pump)	Heat 1.2°F; Cool 1.5°F
Operating Ambient	32°F to +105°F (0 to +41°C)
Operating Humidity	90% non-condensing max.
Shipping Temperature Range	-4 to +150°F (-20 to +65°C)
Dimensions Thermostat	4-9/16"H x 5-13/16"W x 1-3/16"D

**CAUTION**

To prevent electrical shock and/or equipment damage, disconnect electric power to system at main fuse or circuit breaker box until installation is complete.

**ATTENTION: MERCURY NOTICE**

This product does not contain mercury. However, this product may replace a product that contains mercury.

Mercury and products containing mercury must not be discarded in household trash. Do not touch any spilled mercury. Wearing non-absorbent gloves, clean up any spilled mercury and place in a sealed container. For proper disposal of a product containing mercury or a sealed container of spilled mercury, place it in a suitable shipping container. Refer to [www.thermostat-recycle.org](http://www.thermostat-recycle.org) for location to send the product containing mercury.

Index	Page
Installation	2
Wiring Connections	2
Thermostat Quick Reference	4
Installer Configuration Menu	5
Operating Your Thermostat	8
Programming	9
Troubleshooting	12

# INSTALLATION

## ⚠ WARNING

Thermostat installation and all components of the control system shall conform to Class II circuits per the NEC code.

### Remove Old Thermostat

A standard heat/cool thermostat consists of three basic parts:

1. The cover, which may be either a snap-on or hinge type.
2. The base, which is removed by loosening all captive screws.
3. The switching subbase, which is removed by unscrewing the mounting screws that hold it on the wall or adapter plate. **Before removing wires from old thermostat, label each wire with the terminal designation from which it was attached.** Disconnect the wires from the old thermostat one at a time. **Do not let wires fall back into the wall.**

### Installing New Thermostat

1. Pull the thermostat body off the thermostat base. Forcing or prying on the thermostat will cause damage to the unit.
2. Place base over hole in wall and mark mounting hole locations on wall using base as a template.
3. Move base out of the way. Drill mounting holes. If you are using existing mounting holes and the holes drilled are too large and do not allow you to tighten base snugly, use plastic screw anchors to secure the base.
4. Fasten base snugly to wall using mounting holes shown in Figure 1 and two mounting screws. Leveling is for appearance only and will not affect thermostat operation.
5. Connect wires to terminal block on base using appropriate wiring schematic (see diagrams on next page).
6. Push excess wire into wall and plug hole with a fire resistant material (such as fiberglass insulation) to prevent drafts from affecting thermostat operation.
7. Carefully line the thermostat up with the base and snap into place.

### Battery Location

2 "AA" alkaline batteries are included in the thermostat at the factory with a battery tag to prevent power drainage. Remove the battery tag to engage the batteries. To replace batteries, set system to OFF, remove thermostat from wall and install the batteries in the rear along the top of the thermostat (see Figure 1).

Figure 1 – Thermostat Base Multi-Stage 1F97-1277

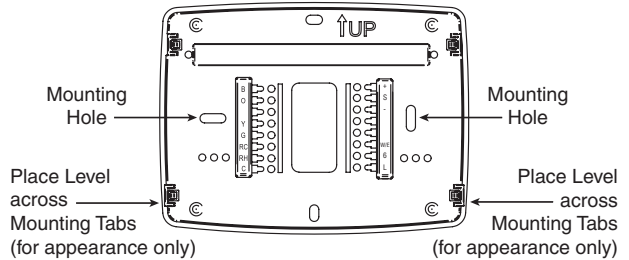

Rear view of thermostat

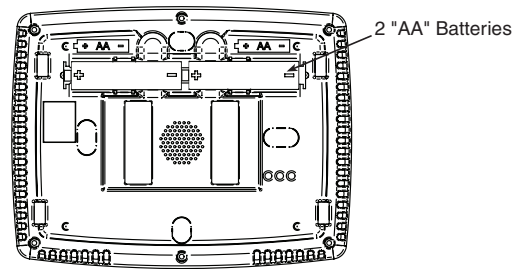

# WIRING CONNECTIONS

Refer to equipment manufacturers' instructions for specific system wiring information. After wiring, see CONFIGURATION section for proper thermostat configuration.

For wiring diagrams, see next page.

Wiring diagrams shown are for typical systems and describe the thermostat terminal functions.

### TERMINAL DESIGNATION DESCRIPTIONS

Terminal Designation	Description
B	Changeover valve for heat pump energized constantly in heating
O	Changeover valve for heat pump energized constantly in cooling
Y	Compressor Relay
G	Fan Relay
RC	Power for Cooling
RH	Power for Heating
C	Common wire from secondary side of cooling
L	For Call for Service indicator for systems with diagnostic connection
6	Powered closed connection for 3-wire zone valve
W	Heat Relay
-	Common (DC) for wired remote temperature sensor
S	Frequency signal from remote temperature sensor
+	Power (DC) to remote temperature sensor

# WIRING CONNECTIONS

## Single Stage Connections

Refer to equipment manufacturers' instructions for specific system wiring information.

This thermostat is designed to operate a single-transformer or two-transformer system.

You can configure the thermostat for use with the following systems:

**SINGLE STAGE** gas, oil or electric.

After wiring, see **INSTALLER CONFIGURATION** section for proper thermostat configuration.

### Single Stage System with Single Transformer

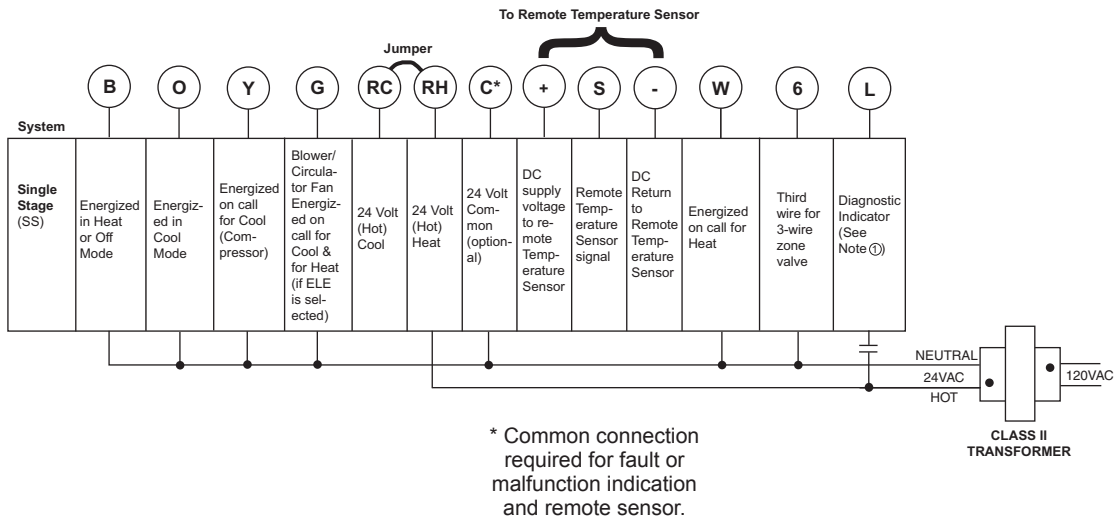

### Single Stage with Two Transformers

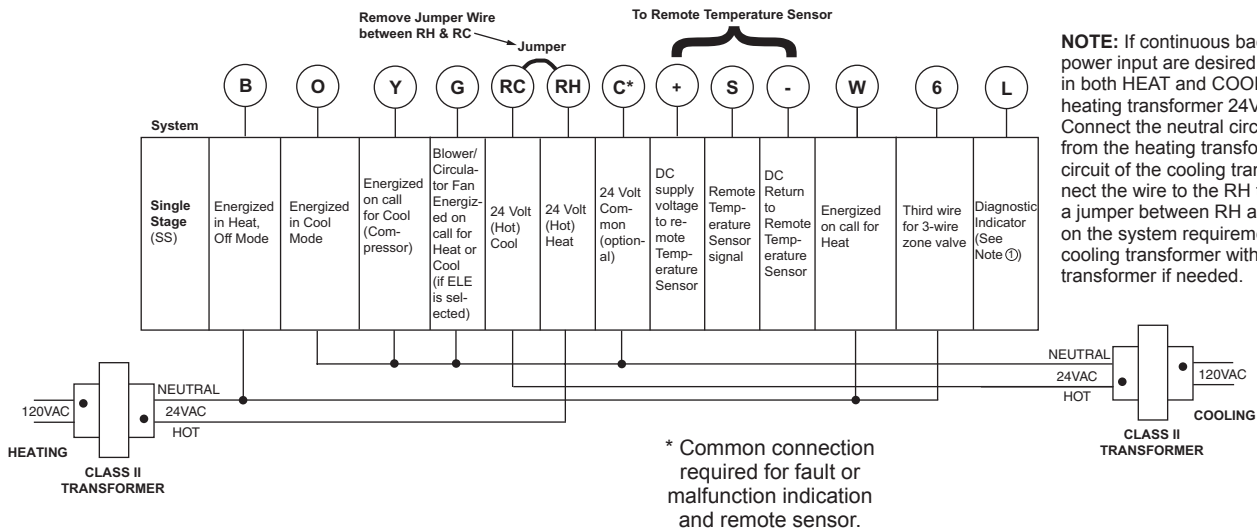

**NOTE:** If continuous backlight or hardwired power input are desired but do not function in both HEAT and COOL modes, cut the heating transformer 24V wires and tape off. Connect the neutral circuit disconnected from the heating transformer to the neutral circuit of the cooling transformer. Disconnect the wire to the RH terminal and install a jumper between RH and RC. Depending on the system requirements, replace the cooling transformer with a 75VA class II transformer if needed.

**NOTE ①:** Connection for Call for Service diagnostic indicator compatible with mechanical or electronic condenser control with Comfort Alert™.

# THERMOSTAT QUICK REFERENCE

## Home Screen Description

Figure 2 – Home Screen Display

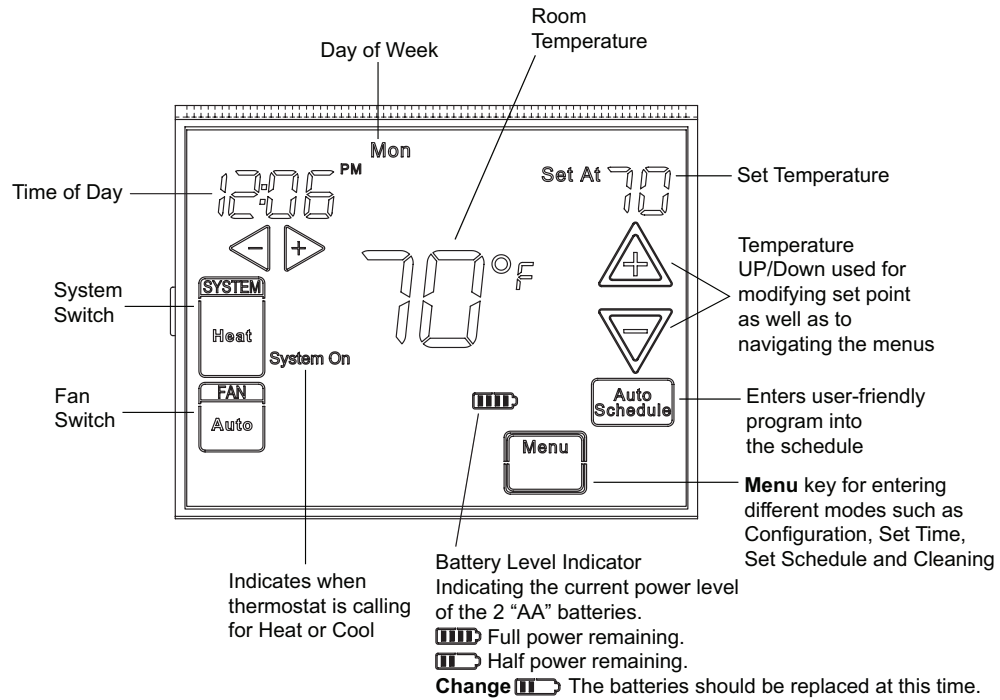

## Programming and Configuration Items



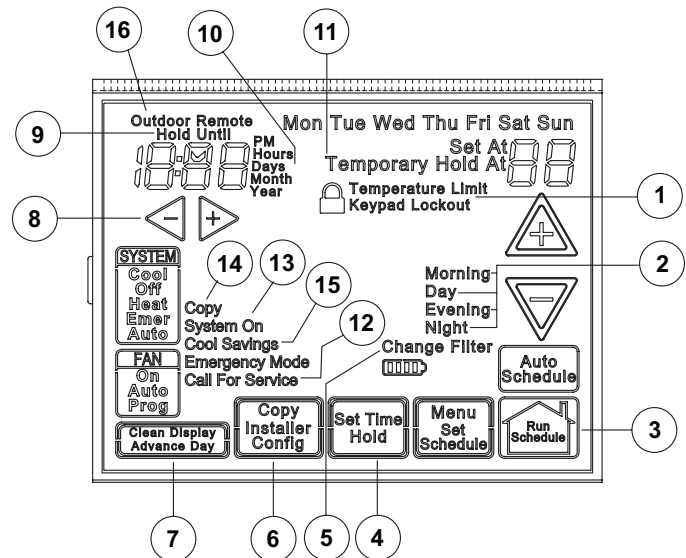

- ① Displays and "Keypad Lockout" when in keypad lockout mode. Displays and "Temperature Limit" and "Keypad Lockout" when limited range is activated and locked. Displays only "Temperature Limit" when limited range is activated.
- ② Indicates period of day being programmed.
- ③ RUN SCHEDULE (run program) button.
- ④ SET TIME button or HOLD temperature button.
- ⑤ Displays "Change Filter" when the system has run for the programmed filter time period as a reminder to change or clean your filter.
- ⑥ COPY button or INSTALLER CONFIG button.
- ⑦ CLEAN DISPLAY button allows 30 seconds to wipe off the display or ADVANCE DAY button for programming.
- ⑧ Used in programming to set time and in configuration menu to change selections.
- ⑨ "Hold Until" indicates the time when a temporary hold period will end.
- ⑩ "Hours" and "Days" displays during steps in installer configuration.
- ⑪ The words "Hold At" are displayed when the thermostat is in the HOLD mode. "Temporary Hold At" is displayed when the thermostat is in a temporary HOLD mode.
- ⑫ "Call For Service" indicates a fault in the heating/cooling system. It does not indicate a fault in the thermostat.



Figure 3 – Programming & Configuration Items































- ⑬ "System On" indicates when heating or cooling stage is energized.
- ⑭ "Copy" indicates the copy program feature is being used during programming.
- ⑮ A steady "Cool Savings" display indicates the feature is enabled in the installer menu. A flashing "Cool Savings" display indicates the feature is active.
- ⑯ "Remote" indicates that the indoor remote temperature sensor, is being accessed. "Outdoor Remote" indicates the outdoor remote temperature sensor is being accessed.

# INSTALLER/CONFIGURATION MENU

To enter the menu: Press the **Menu** touch key. Press and hold for 5 seconds the **Installer Config** touch key. This displays menu item #1 in the table below. Press  to advance to the next menu item or  to return to a previous menu item. Press  or  to change a menu item.

**Installer Note:** To default the programming, clock and Configuration Menu to the Factory Default Settings, press the ,  and SYSTEM keys simultaneously. The thermostat display will go blank for a few seconds, and then all segments will display momentarily.

CONFIGURATION MENU						
Menu Reference Number	Programmable	Non-Programmable	Press Button	Displayed (Factory Default)	Press  or  to select from listed options	Comments
1	1	1		(ELE)	GAS	GAS setting: furnace controls blower ELE setting: thermostat controls blower
2	2	2		Days, (7) P	5-1-1 or 0	Programs per week. (0 = non-programmable)
3	3	NA		PS (4)	2	Program periods per day 4 = Morning, Day, Evening, Night 2 = Day, Night
4	4	3		Cool-Off-Heat-Heat-Auto	Cool-Off-Heat, Off-Heat, Cool-Off	System switch configuration
5	5	NA		E (On)	OFF	Selects Energy Management Recovery, E (with programming option on)
6	6	4		Cr, Heat (FA)	SL	Selects Adjustable Anticipation, cycle rate, Heat
7	7	5		Cr, Cool (FA)	SL	Selects Adjustable Anticipation, cycle rate, Cool
8	8	6		CL (OFF)	On	Selects Compressor Lockout
9	9	7		dL (On)	OFF	Selects Continuous Display backlight & intensity
10	10	8		dL (LO)	HI	Selects Backlight Intensity
11	11	9		0	4, LO to 4, HI	Selects Adjustable Ambient Temperature Display [range -4 (LO) to +4 (HI)]
12	12	10		°F	°C	Selects °F/°C Display (temperature units in Fahrenheit or Celsius)
13	13	11		b (On)	OFF	Selects audible Beeper On/Off
14	14	12		dS (On)	OFF	Selects Daylight Saving Time calculation
15	15	13		AS, Heat (On)	OFF	Selects Automatic Schedule for comfort temperature Programming, heat mode
16	16	14		AS, Cool (On)	OFF	Selects Automatic Schedule for comfort temperature Programming, cool mode
17	17	15		CS, (OFF) Cool Savings	1-2-3-4-5-6	Selects Cool Saving Feature & amount
18	18	16		HL, Heat (99)	62-98	TEMPERATURE LIMIT, HEAT (max. heat set point)
19	19	17		LL, Cool (45)	46-82	TEMPERATURE LIMIT, COOL (min. cool set point)
20	20	18		OFF,  Keypad Lockout	L (total), P (partial), Temperature Limit (limited temperature range)	Selects Keypad Lockout
				000	001-999	Selects Keypad Lockout Combination (active only if keypad Lockout is selected)
21	21	19		Remote (OFF)	On	Remote temperature sensor, enable/disable
				In, Remote	Outdoor Remote	Remote temperature sensor (Indoor/Outdoor)
				LS (On)	OFF	Local temp. Sensor enable/disable (only when Indoor Remote is selected On)
22	22	20		Change Filter (OFF)	On	Selects Change filter feature
				200 Hours	25-1975 (in increments of 25 hours)	Change filter, duration hours

# INSTALLER/CONFIGURATION MENU

- 1) GAS or Electric (ELE) fan operation. If the heating system requires the thermostat to energize the fan, select ELE. Select GAS if the heating system energizes the fan on a call for heat. **Note: Resetting the thermostat switches the option to ELE.**
- 2) **Programs per week** – This control can be configured for 7 independent day or 5/1/1 day programming or nonprogrammable modes. Default is 7-day mode. The display indicates **"7 Days"** as default. Other options **"5 Days"** or **"0 Days"** can be selected by pressing touch keys,  $\triangleright$  or  $\triangleleft$ . If **"0 Days"** is selected for non-programmable mode, the step for EMR will be skipped, as this feature will not be available in this mode.
- 3) **Program Steps per day** – This control can be configured for 4 or 2 program steps per day. Default is **"4 PS"** and can be toggled between 4 PS and 2 PS by pressing the  $\triangleright$  or  $\triangleleft$  touch keys.
- 4) **System Switch Configuration** – This thermostat is configured for Heat and Cool with Auto changeover default (Cool-Off-Heat-Auto). Can be configured as Heat & Cool (Cool-Off-Heat), or Heat Only (Off-Heat), or Cool Only (Cool-Off).
- 5) **Energy Management Recovery (EMR)** – (this step is skipped if configured as non-programmable). When set to "On" causes the thermostat to start heating or cooling early to make the building temperature reach the program setpoint at the time you specify.  
**Example:** Let us say, the heating program is 65°F at night and 70° at 7 AM. If the building temperature is 65°F, the difference is 5°F. Allowing 5 minutes per °F rise, the thermostat setpoint will change to 70° at 6:35 AM. Cooling allows more time per °F, because it takes longer to reach temperature.
- 6 & 7) **Cycle Rate Selection** – The factory default setting is fast cycle (FA Cr) in all modes (Heat, Cool). To slow cycling (SL, Cr), press touch keys  $\triangleright$  or  $\triangleleft$  toggle between FA & SL. The cycle rates are as below different selections:
 

Mode	Fast rate	Slow rate
Heat	0.6°F	1.2°F
Cool	1.2°F	1.7°F
- 8) **Select Compressor Lockout (CL)** – Selecting CL On will cause the thermostat to wait 5 minutes between cooling cycles. This is intended to help protect the compressor from short cycling. Some of the newer compressors have already got a time delay built in and do not require this feature to be activated in the thermostat. Your compressor manufacturer can tell you if this lockout feature is already present in their system.  
When the thermostat compressor time delay is activated, it will flash the setpoint for up to five minutes.
- 9) **Select Continuous Backlight** – In low lighting conditions, display backlight improves the display contrast. When C terminal is connected, selecting dL On will turn the backlight on continuously. Selecting dL Off will turn the backlight on momentarily after any key is pressed. When C terminal is not powered (battery only), dL On enables the momentary backlight whenever a key is pressed.
- 10) **Select Backlight Intensity** – This thermostat has the ability to provide two selectable intensities of the backlight: HI and LO. Using  $\triangleright$  or  $\triangleleft$  touch keys you can toggle the selection between HI and LO.
- 11) **Select Temperature Display Adjustment 4 LO to 4 HI** This allows you to adjust the room temperature display by an amount in the range of -4°F to +4°F in 1° steps by using the  $\triangleright$  or  $\triangleleft$  touch keys. Your thermostat was accurately calibrated at the factory, however you have the option to change the display temperature value to match your previous thermostat, if you so prefer.
- 12) **Select °F or °C Readout** – Select the desired temperature unit by pressing  $\triangleright$  or  $\triangleleft$ . Factory default is °F.
- 13) **Select Audio Prompting (Beeper) On or Off** – Factory default setting is on (b, On). If you wish to turn off the beeper select OFF.
- 14) **Select Daylight Saving Time Calculation** – This feature will allow the thermostat to calculate the DST automatically and apply it to the Real Time Clock display. Default On. Use  $\triangleright$  or  $\triangleleft$  touch keys to select the feature, OFF.
- 15 & 16) **Select Automatic Schedule** – With just one touch of the **Auto Schedule** key this feature allows you to program a desired comfort temperature into all the program periods along with a 6° set back for night periods of both Heat and Cool programs. Factory default is "On" for both. When **Heat AS On** and **Cool AS On** are activated while in Heat or Cool mode, select desired setpoint temperature and press **Auto Schedule**. **Auto Schedule** will flash, press it again to copy. This value will be copied into all the morning, day and evening program periods. The night program periods will be with a 6°F set back.
- 17) **Select Cool Savings™**: With Cool Savings™ enabled, the thermostat will make small adjustments to the sensed temperature during periods of high demand to reduce AC system running time and save energy. When the cooling system has been running for more than 20 minutes, humidity in the home will be lower and a higher temperature will feel comfortable. After 20 minutes of run time, the thermostat will start decreasing the sensed temperature in steps of less than one degree as the system continues to run. These adjustments will eventually cause the system to satisfy the thermostat to turn the system off and reduce the energy consumption. When the Cool Savings™ feature is active and making adjustments, the display will flash **"CoolSavings"**. The amount of the adjustments to the sensed temperature is dependent on the Cool Savings™ value that is set, 1 being the least adjustment and 6 being the most adjustment. With this feature set to OFF, no change will occur when the AC system is continuously running during the periods of high demand. Periods of high demand will normally occur during the late afternoon and early evening on the hottest days of the summer. As demand lessens the adjustments to sensed temperature are reversed until sensed temperature returns to normal and **"CoolSavings"** no longer flashes.

## INSTALLER/CONFIGURATION MENU

---

- 18) **Heat Temperature Limit Range** – This feature adjusts the highest setpoint temperature for heat. The default setting is 99°F. It can be changed between 62°F and 98°F by pressing the  $\triangleright$  or  $\triangleleft$  key. The "**temperature limit**" icon will be displayed to the left of your setpoint temperature when using this feature. The "**temperature limit**" icon will flash if an attempt is made to adjust the temperature beyond the range selected.
- 19) **Cool Temperature Limit Range** – This feature adjusts the lowest setpoint temperature for cool. The default setting is 45°F. It can be changed between 46°F and 82°F by pressing the  $\triangleright$  or  $\triangleleft$  key. The "**temperature limit**" icon will be displayed to the left of your setpoint temperature when using this feature. The "**temperature limit**" icon will flash if an attempt is made to adjust the temperature beyond the range selected.
- 20) **Keypad Lockout** – This step allows you to select the type of lockout or limited range security required. If no lockout or limited range security is required, press  $\triangle$  to advance the menu.  
Three security settings are available in this menu item. Use the  $\triangleright$  or  $\triangleleft$  keys to select the lockout desired. Lockout selections are:  
"**Keypad Lockout and L**" = Total Lockout. Total Lockout locks all keys.  
"**Keypad Lockout and P**" = Partial Lockout. Partial Lockout allows only the  $\triangle$  or  $\nabla$  keys to operate within your set temperature limits.  
"**Temperature Limit/Keypad Lockout**" prevents changing the temperature limits in the Configuration Menu.  
**Keypad Lockout Combination Number Selection**  
Display will read "**OFF**" "**Keypad Lockout**".  
Skip this step and continue through the configuration menu items 21 thru 22 if you require an Air Filter Change out indicator or Humidifier Pad Change out indicator by pressing the  $\triangle$  button to advance.  
Return to this point when you are ready to start your selected lock-out and continue by:  
Pressing  $\triangleright$  or  $\triangleleft$  keys to select ON.  
Press  $\triangle$ . Display will read "**000**".  
Pressing  $\triangleright$  or  $\triangleleft$  keys to select your keypad lockout combination number. Note: "**000**" is not a valid combination choice.  
**Record the number you select for future use.**  
Press  $\triangle$  to exit the menu. The security feature you select will start in 10 seconds. The system button will remain active for 10 seconds to allow setting Heat, Off, Cool or Auto.
- 21) **Select Remote Temperature Sensor** – This control allows one wired remote temperature sensor (indoor or outdoor) be connected to it and indicates the measured temperature in clock digits. This menu enables you to select the remote sensor and also configure it as indoor or outdoor temperature sensor. Factory default is off. Select **Remote On** and **Remote in** (for indoor) or **Outdoor Remote**.  
**Local Temperature Sensor disable** – This is applicable only when indoor remote temperature sensor is enabled. Factory default is **On LS**. You can make it **Off LS** if you desire by using  $\triangleright$  or  $\triangleleft$  touch keys. Then, only the indoor remote temperature reading will be used for control.
- 22) **Select Change Filter Run Time** – The thermostat will display "**Change Filter**" after a set time of blower operation. This is a reminder to change or clean your air filter. This time can be set from 25 to 1975 hours in 25 hour increments. A selection of OFF will cancel this feature. When "**Change Filter**" is displayed, you can clear it by pressing Clean Display. In a typical application, 200 hours of run time is approximately 30 days.

## OPERATING YOUR THERMOSTAT ————— IMPORTANT! —————

### Choose the Fan Setting (Auto or On)

Fan **Auto** is the most commonly selected setting and runs the fan only when the heating or cooling system is on.

Fan **On** selection runs the fan continuously for increased air circulation or to allow additional air cleaning.

### Choose the System Setting (Cool, Off, Heat, Auto)

Press the SYSTEM button to select:

**Heat:** Thermostat controls only the heating system.

**Off:** Heating and Cooling systems are off.

**Cool:** Thermostat controls only the cooling system.

**Auto:** Auto Changeover is used in areas where both heating and cooling may be required on the same day. **AUTO** allows the thermostat to automatically select heating or cooling depending on the indoor temperature and the selected heat and cool temperatures. When using **AUTO**, be sure to set the Cooling temperatures more than 1° Fahrenheit higher than the heating temperature.

### Manual Operation for Non-Programmable Thermostats

Press the SYSTEM button to select Heat or Cool and use the  $\Delta$  or  $\nabla$  buttons to adjust the temperature to your desired setting. After selecting your desired settings you can also press the SYSTEM button to select **AUTO** to allow the thermostat to automatically change between Heat and Cool.

### Manual Operation (Bypassing the Program) Programmable Thermostats

Press  $\Delta$  or  $\nabla$  and the HOLD button and adjust the temperature wherever you like. This will override the program. The **HOLD** feature bypasses the program and allows you to adjust the temperature manually, as needed. Whatever temperature you set in **HOLD** will be maintained 24 hours a day, until you manually change the temperature or press **Run Schedule** to cancel **HOLD** and resume the programmed schedule.

### Program Override (Temporary Override)

Press  $\Delta$  or  $\nabla$  buttons to adjust the temperature. This will override the temperature setting for a (default) four hour override period. The override period can be shortened by pressing  $\triangleleft$  or lengthened by pressing  $\triangleright$ . Program Override period can range from 15 minutes to 7 days.

**Example:** If you turn up the heat during the morning program, it will be automatically lowered later, when the temporary hold period ends. To cancel the temporary setting at any time and return to the program, press **Run Schedule**.

If the SYSTEM button is pressed to select **AUTO** the thermostat will change to Heat or Cool, whichever ran last. If it switches to heat but you want cool, or it changes to cool but you want heat, press both  $\Delta$  or  $\nabla$  buttons simultaneously to change to the other mode.

## PROGRAMMING —————

### Set Current Time and Day

- 1) Press Menu key to enter installer menu. Then press Set Time once to indicate hour & A or P designation in clock display.
- 2) Press and hold either the  $\triangleright$  or  $\triangleleft$  touch key until you reach the correct hour and A or P designation.
- 3) Press Set Time again to display minutes only in clock display.
- 4) Press and hold either the  $\triangleright$  or  $\triangleleft$  touch keys until you reach the correct minutes.
- 5) Press Set Time once again to display year.
- 6) Press and hold either the  $\triangleright$  or  $\triangleleft$  touch key until you reach the correct year.
- 7) Press Set Time once again to display month.
- 8) Press and hold either the  $\triangleright$  or  $\triangleleft$  touch key until you reach the correct month.
- 9) Press Set Time once again to display date of the month along with day of the week at top row (which is automatic).
- 10) Press and hold either the  $\triangleright$  or  $\triangleleft$  touch key until you reach the correct day of the month and day of the week is automatically calculated and displayed at the top row.
- 11) Press Run Schedule once; now the display will show the correct time and room temperature.

### Automatic Daylight Saving Calculation

The Real Time Clock will adjust automatically for daylight savings time, in the following manner:

Increment one hour at 2 AM on the second Sunday of March and decrement one hour at 2 AM on the first Sunday of November. (New DST effective 2007).

The daylight saving feature can be enabled or disabled in installer configuration mode. Default is **ds ON** (enabled). After entering installer configuration mode, momentarily press  $\Delta$  or  $\nabla$  touch key until the display indicates **ds** (in actual temperature digits) and on (default – in clock digits).  $\triangleright$  and  $\triangleleft$  keys will toggle display and operation from on to OFF.

### Programming Tip: Copy Button

You may copy any daily program to another day or group of days by pressing the Copy button. In 7 day programming mode when the Copy button is pressed, the other 6 days of the week will flash. To copy the current program into the remaining six days, simply press the Copy button again. To copy the current program to another day of the week, press Advance Day to select the day and press Copy to paste the program. In 5/1/1 day programming mode the copy function is similar. The weekday (Mon-Fri) program can be copied to Sat and Sun (both flashing) or use Advance Day to choose Sat or Sun and press the Copy button to paste the program.



# PROGRAMMING

---

Fill in the blank schedule on the next page then:

## Enter the Heating Program

- 1) Press the Menu button and then press Set Schedule. Press SYSTEM button to select either "**Heat**" or "**Cool**" in the system switch area indicating the active mode being programmed. You can switch to the other mode by pressing the system switch at any time.
- 2) The top of the display will show the day(s) being programmed. The time and set at temperature are also displayed. "**Morning**" will also be displayed to indicate the period.
- 3) Press  $\Delta$  or  $\nabla$  key to change the temperature to your selected temperature for the 1st heating period (Morning).
- 4) Press  $\triangleright$  or  $\triangleleft$  key to adjust the start time for period. The time will change in 15 minute increments.
- 5) Press **FAN** to select **Auto** or **Prog**.
- 6) After you have set the time and the temperature for the period to begin, press Set Schedule to advance to the next program period.
- 7) Repeat steps 2 through 6 until all of the program times and temperatures are set for all program periods on that day.
- 8) Press "Advance Day" to change to the next day and repeat steps 2 through 8.
- 9) When programming is complete and all of the times and temperatures match your desired heating schedule, press Run Schedule. The thermostat will now run your program.

## Enter the Cooling Program

- 1) Press the SYSTEM button until the Cool icon appears.
- 2) Follow **Enter Heating Program** instructions for entering cooling times and temperatures.

## Automatic Schedule

This feature provides a method to program every day with the most popular time and temperature profile using one key press. For this feature to be available, the Auto schedule options (**AS Cool or AS Heat**) should be set on in the installer configuration.

Select the desired "Comfort Temperature" in the setpoint. When the **Auto Schedule** touch key is pressed, it will start flashing indicating that it is now ready to insert the displayed temperature setpoint as the "Comfort Temperature" for the selected system mode currently in (Heat/Cool). A second press of the **Auto Schedule** touch key will complete the process. A 6°F setback temperature will also be inserted for the night step. Once it is done, the touch key display **Auto Schedule** will disappear disabling any further operation of **Auto Schedule** touch key. If desired it can be enabled again in the installer configuration menu.

## Entering Fan Program

In the Set Schedule mode, the **FAN** key is used to select the fan operation during a program period. The default state of the **Fan** key is **FAN Auto** (fan runs during a call for cool but not on a call for heat). It can be changed to **FAN Prog** (fan runs during a program period). Each press of the FAN key will change the mode of the fan between **Auto** and **Prog**.

In the Run mode, when a program period that has **FAN Prog** begins, the fan will turn on and stay on during the complete period. The display will show **FAN On Prog**. Pressing the **FAN** key will change **FAN On Prog** to **On** (fan running continuously) or **Auto**. To return to **FAN On Prog**, press **Run Schedule**.

# PROGRAMMING

## Energy Saving Factory Pre-Program

The 1F97-1277 thermostats are programmed with the energy saving settings shown in the table below for all days of the week. If this program suits your needs, simply set the thermostat clock and press the RUN button.

The table below shows the factory set heating and cooling schedule for all days of the week.

	*Wake Up (Morning)		Leave For Work (Day)		*Return Home (Evening)		Go To Bed (Night)	
<b>Heating Program</b>	6:00 AM	70°F	8:00 AM	62°F	5:00 PM	70°F	10:00 PM	62°F
<b>Cooling Program</b>	6:00 AM	78°F	8:00 AM	85°F	5:00 PM	78°F	10:00 PM	82°F

\* You can eliminate these two program periods in the configuration menu (reference #3) if the building is occupied all day. Day will change to 6:00 am and can be programmed as required.

## Planning Your Program – Important

The Heating and Cooling Program schedules below allow you to pencil in your own program times and temperatures.

The 1F97-1277 comes configured for 7 day programming and can also be configured for 5+1+1 programming (see configuration section).

Factory settings are listed on Monday, Saturday and Sunday. If you are re-programming a 5+1+1 day schedule, pencil in your own times and temperatures directly below the factory times and temperatures.

If you are re-programming a 7 day fill in all lines with the times and temperatures you want.

Keep the following guidelines in mind when planning your program.

- In Heating, lower temperatures will save energy.
- In Cooling, higher temperatures will save energy.
- **If you plan on using Auto Changeover, do not program the heating higher than the cooling.**

## Worksheet for Re-Programming 5+1+1 and 7 Day Program

Heating Program	Wake Up (Morning)			Leave For Work (Day)			Return Home (Evening)			Go To Bed (Night)		
	Time	Temp	Fan	Time	Temp	Fan	Time	Temp	Fan	Time	Temp	Fan
<b>MON</b>	6:00 AM	70°F	Auto	8:00 AM	62°F	Auto	5:00 PM	70°F	Auto	10:00 PM	62°F	Auto
<b>TUE</b>												
<b>WED</b>												
<b>THU</b>												
<b>FRI</b>												
<b>SAT</b>	6:00 AM	70°F	Auto	8:00 AM	62°F	Auto	5:00 PM	70°F	Auto	10:00 PM	62°F	Auto
<b>SUN</b>	6:00 AM	70°F	Auto	8:00 AM	62°F	Auto	5:00 PM	70°F	Auto	10:00 PM	62°F	Auto

Cooling Program	Wake Up (Morning)			Leave For Work (Day)			Return Home (Evening)			Go To Bed (Night)		
	Time	Temp	Fan	Time	Temp	Fan	Time	Temp	Fan	Time	Temp	Fan
<b>MON</b>	6:00 AM	78°F	Auto	8:00 AM	85°F	Auto	5:00 PM	78°F	Auto	10:00 PM	82°F	Auto
<b>TUE</b>												
<b>WED</b>												
<b>THU</b>												
<b>FRI</b>												
<b>SAT</b>	6:00 AM	78°F	Auto	8:00 AM	85°F	Auto	5:00 PM	78°F	Auto	10:00 PM	82°F	Auto
<b>SUN</b>	6:00 AM	78°F	Auto	8:00 AM	85°F	Auto	5:00 PM	78°F	Auto	10:00 PM	82°F	Auto

## PROGRAMMING

---

### Wired Remote Temperature Sensing

One remote temperature sensor can be installed indoor or outdoor and connected to the thermostat by a maximum cable length of 100 meters (300 ft). Three terminals, +, S & - are provided on the terminal block to connect to the White-Rodgers standard wired remote sensor. This sensor will be read by the thermostat only when 24VAC is present.

When used as indoor sensor, the readings can be weighted with the local sensor for specific program periods. User can enable or disable the remote sensor in the installer configuration mode and also the outdoor temperature can be selected to show on the display.

Once in the installer configuration mode, momentarily press the  $\Delta$  or  $\nabla$  touch key until display indicates **Remote** (at the top left of the LCD) and OFF (default – in clock digits).

Pressing  $\rightarrow$  or  $\leftarrow$  touch key will toggle the operation and display from **Remote OFF** to **Remote On**.

When **Remote On** is selected, press  $\Delta$  key for the display to indicate **Remote In** (for indoor remote).

The  $\Delta$  or  $\nabla$  keys will toggle the operation and display from **Remote In** to **Outdoor Remote**.

When any remote is selected the temperature will display in the clock digits for one second alternating with the current time for three seconds when in **Run Schedule** mode.

**Outdoor Remote** will indicate at the top left of display for outdoor remote reading.

Only **Remote** will show at top left for indoor remote reading. (°F or °C will not indicate with remote temperature readings).

Sensing Range:

Outdoor temperature range is -40 to 140°F

Indoor temperature range is 32°F to 99°F

### Weight of Remote Reading:

When in view schedule mode the weight of the indoor remote sensor will be shown in the left actual temperature digits designated as A2 (default for average weight), H4 (high weight) or L1 (low weight). The period (Morning, Day, Evening, Night) will also be shown to the right of the weight value in the actual temperature digits.

When in view schedule mode, press  $\rightarrow$  and  $\leftarrow$  keys at the same time to sequence the indoor remote temperature sensor weight from A2 to H4 to L1 and back to A2 for each of the program period times for each day. (The H4 weight is twice the weight of A2 and A2 is twice the weight of L1).

When **Remote In** is selected (with **Remote** selected to **On**), press  $\Delta$  key for the display to indicate the status of the local sensor **LS On** (default for thermostat local sensor operation). The  $\Delta$  and  $\nabla$  keys will toggle the function and display from **LS** (shown in actual temperature digits) and **On** (shown in clock digits) to **LS OFF** to designate the local sensor is disabled.

The local sensor may be disabled only if the indoor remote sensor is enabled and functional.

If the indoor remote sensor is disabled or not functional, the local sensor will automatically enable and display in the run schedule mode.

The actual temperature displayed in the run mode is the mathematical weighted sum of the two temperature sensors – local and indoor remote.

(Outdoor remote sensor is not used for this computation).

If the remote sensor is absent or not enabled then the actual temperature will be as measured by the local sensor.

# TROUBLESHOOTING

## Reset Operation

**Note:** When thermostat is reset, installer configuration menu settings and programming will reset to factory settings.

If a voltage spike or static discharge blanks out the display or causes erratic thermostat operation, you can reset the thermostat by removing the wires from terminals R and C (do not short them together) and removing batteries for 2 minutes. After resetting the thermostat, replace the wires and batteries. If the thermostat has been reset and still does not function correctly contact your heating/cooling service person or place of purchase.

Symptom	Possible Cause	Corrective Action
<b>No Heat/No Cool/No Fan (common problems)</b>	<ol style="list-style-type: none"> <li>1. Blown fuse or tripped circuit breaker.</li> <li>2. Furnace power switch to OFF.</li> <li>3. Furnace blower compartment door or panel loose or not properly installed.</li> <li>4. Loose connection to thermostat or system.</li> </ol>	Replace fuse or reset breaker. Turn switch to ON. Replace door panel in proper position to engage safety interlock or door switch. Tighten connections.
<b>No Heat</b>	<ol style="list-style-type: none"> <li>1. Pilot light not lit.</li> <li>2. Furnace Lock-Out Condition. Heat may also be intermittent.</li> <li>3. Heating system requires service or thermostat requires replacement.</li> </ol>	Re-light pilot. Many furnaces have safety devices that shut down when a lock-out condition occurs. If the heat works intermittently contact the furnace manufacturer or local HVAC service person for assistance. <b>Diagnostic:</b> Set SYSTEM Switch to <b>HEAT</b> and raise the setpoint above room temperature. Within a few seconds the thermostat should make a soft click sound. This sound usually indicates the thermostat is operating properly. If the thermostat does not click, try the reset operation listed above. If the thermostat does not click after being reset contact your heating and cooling service person or place of purchase for a replacement. If the thermostat clicks, contact the furnace manufacturer or a HVAC service person to verify the heating is operating correctly.
<b>No Cool</b>	<ol style="list-style-type: none"> <li>1. Cooling system requires service or thermostat requires replacement.</li> </ol>	Same as diagnostic for No Heat condition except set the thermostat to <b>COOL</b> and lower the setpoint below the room temperature. There may be up to a five minute delay before the thermostat clicks in Cooling.
<b>Heat, Cool or Fan Runs Constantly</b>	<ol style="list-style-type: none"> <li>1. Possible short in wiring.</li> <li>2. Possible short in thermostat.</li> <li>3. Possible short in heat/cool/fan system.</li> <li>4. FAN Switch set to Fan <b>ON</b>.</li> </ol>	Check each wire connection to verify they are not shorted or touching together. No bare wire should stick out from under terminal block. Try resetting the thermostat as described above. If the condition persists the manufacturer of your system or service person can instruct you on how to test the Heat/Cool system for correct operation. If the system operates correctly, replace the thermostat.
<b>Thermostat Setting &amp; Thermostat Thermometer Disagree</b>	<ol style="list-style-type: none"> <li>1. Thermostat thermometer setting requires adjustment.</li> </ol>	The thermometer can be adjusted +/- 4 degrees. See Temperature Display Adjustment in the Configuration Menu section.
<b>Furnace (Air Conditioner) Cycles Too Fast or Too Slow (narrow or wide temperature swing)</b>	<ol style="list-style-type: none"> <li>1. The location of the thermostat and/or the size of the Heating System may be influencing the cycle rate.</li> </ol>	Digital thermostats provide precise control and cycle faster than older mechanical models. The system turns on and off more frequently but runs for a shorter time so there is no increase in energy use. If you would like an increased cycle time, choose <b>SL</b> for slow cycle in the Configuration menu, step 6 (heat) or 7 (cool). If an acceptable cycle rate is not achieved, contact a local HVAC service person for additional suggestions.
<b>Forgot Keypad Lockout Code</b>		Press the menu button (button will disappear) and hold in for 20 seconds. This unlocks the thermostat.

White-Rodgers is a business of Emerson Electric Co.

The Emerson logo is a trademark and service mark of Emerson Electric Co.

White  
Rodgers™

www.white-rodgers.com  
www.emersonclimate.com

  
**EMERSON**  
Climate Technologies