

Contents

Product Information

Important Safeguards	2
Advantages of This Product Are	5
Read Carefully before Using	6
Identification of Controls	7
Remote Control	11

Installation

Connecting up your player with RF lead	12
Connecting with Other VCR or Camcorder	14
Connecting with Audio	16
Connecting to a television with Component jack and a Dolby Digital Amp.	17

Basic Operation

Initial Installation	18
Setting time and date, OSD ON & OFF	20
Output Select	21
DVD Playback	22
VCR Playback	23
Recording	24

VCR Operation

Tuning in New Stations	27
Timer Recording	30
More Functions	32
Connections and Assembling	35

DVD Operation

Playing a desired scene	37
Confirming the current PLAYING TIME	42
Selecting an AUDIO language, SUBTITLE language and 3D Audio.....	44
Selecting ZOOM and Multi Angle.....	46
Program Playback	47
About MP3 , JPG and DivX® discs	48
Displaying menus in a disc	53
Progressive Scan Mode.	54

Set-up

Language Setup	55
Video Setup	57
Audio Setup.....	58
Others Setup	59

The others

About DVD.....	61
Basic information about VCR and Videotape....	63
Trouble Shooting (VCR).....	64
Trouble Shooting (DVD)	66
Specifications	67

Important Safeguards

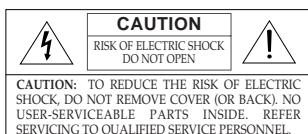

The lightning flash with arrowhead symbol, within an equilateral triangle, is intended to alert the user to the presence of uninsulated "dangerous voltage" within the product's enclosure that may be of sufficient magnitude to constitute a risk of electric shock.



The exclamation point within an equilateral triangle is intended to alert the user to the presence of important operating and servicing instructions in the literature accompanying the appliance.

WARNING: TO REDUCE THE RISK OF FIRE OR ELECTRIC SHOCK, DO NOT EXPOSE THIS APPLIANCE TO RAIN OR MOISTURE.

CAUTION: TO PREVENT ELECTRIC SHOCK, MATCH WIDE BLADE OF PLUG TO WIDE SLOT, FULLY INSERT.

IMPORTANT FOR LASER PRODUCTS

- **LASER:** This Digital Video Disc Player employs a Laser System. To ensure proper use of this product please read this instruction manual carefully and retain for future reference. Should the unit require maintenance, contact an authorized service location - see service procedure.

Use of control adjustments or the performance of procedures other than those specified may result in hazardous radiation exposure.

To prevent direct exposure to the laser beam, do not try to open the enclosure. Visible laser radiation when open and interlocks defeated.

DO NOT STARE INTO THE BEAM.

- **DANGER:** Visible laser radiation when open and interlock failed or defeated. Avoid direct exposure to beam.

- **CAUTION:** Do not open the top cover. There are no user serviceable parts inside the Unit; leave all servicing to qualified service personnel.

CLASS 1 LASER PRODUCT
LUOKAN 1 LASERLAITE
KLASS 1 LASERAPPARAT

CAUTION: Any changes or modification in construction of this device which are not expressly approved by the party responsible for compliance could void the user's authority to operate the equipment.

- **Make sure the unit should be placed at least 8cm apart from the other home appliances or the obstacles to get sufficient ventilation.**
- **This unit shall not be exposed to dripping or splashing and no objects filled with liquids, such as vases, shall be placed on this unit.**
- **Switching it off does not disconnect it from the mains (stand-by). To disconnect it from the mains, you have to unplug it.**
- **The system is not completely disconnected from the mains when the \odot /I button is set to the \odot position.**

Important Safeguards

This set has been designed and manufactured to assure personal safety. Improper use can result in electric shock or fire hazard. The safeguards incorporated in this unit will protect you if you observe the following procedures for installation, use and servicing. This unit is fully transistorized and does not contain any parts that can be repaired by the user.

1 READ INSTRUCTIONS

All the safety and operating instructions should be read before the unit is operated.

2 RETAIN INSTRUCTIONS

The safety and operating instructions should be retained for future reference.

3 HEED WARNINGS

All warnings on the unit and in the operating instructions should be adhered to.

4 FOLLOW INSTRUCTIONS

All operating and use instructions should be followed.

5 CLEANING

Unplug this unit from the wall outlet before cleaning. Do not use liquid cleaners or aerosol cleaners. Use a damp cloth for cleaning.

6 ATTACHMENTS

Do not use attachments unless recommended by the unit's manufacturer as they may cause hazards.

7 WATER AND MOISTURE

Do not use this unit near water- for example, near a bath tub, wash bowl, kitchen sink or laundry tub, in a wet basement, or near a swimming pool.

8 ACCESSORIES

Do not place this unit on an unstable cart, stand, tripod, bracket, or table. The unit may fall, causing serious injury to a child or adult as well as serious damage to the unit. Use this unit only with a cart, stand, tripod, bracket, or table recommended by the manufacturer.

PORTABLE CART WARNING
(symbol provided by RETAC)



8A

A unit and cart combination should be moved with care. Quick stops, excessive force, and uneven surfaces may cause the product and cart combination to overturn.

9 VENTILATION

Slots and openings in the case are provided for ventilation to ensure reliable operation of the unit and to protect it from overheating. These openings must not be blocked or covered. These openings must not be blocked by placing the unit on a bed, sofa, rug, or other similar surface. This unit should never be placed near or over a radiator or heat radiator. This unit should not be placed in a built-in installation such as a bookcase or rack unless proper ventilation is provided or the manufacturer's instructions have been adhered to.

10 POWER SOURCES

This unit should be operated only from the type of power source indicated on the marking label. If you are not sure of the type of power supply to your home, consult your dealer or local power company. For units intended to operate from battery power, or other sources, refer to the operating instructions.

11 GROUNDING OR POLARIZATION

This unit is equipped with a polarized alternating-current line plug (a plug having one blade wider than the other). This plug will fit into the power outlet only one way.

This is a safety feature. If you are unable to insert the plug fully into the outlet, try reversing the plug. If the plug still fails to fit, contact your electrician to replace your obsolete outlet. To prevent electric shock, do not use this polarized plug with an extension cord, receptacle, or other outlet unless the blades can be fully inserted without blade exposure. If you need an extension cord, use a polarized cord.

12 POWER-CORD PROTECTION

Power-supply cords should be routed so that they are not likely to be walked on or pinched by items placed upon or against them, paying particular attention to cords at plugs, convenience receptacles, and the point where they exit from the unit.

Important Safeguards

13 LIGHTNING

For added protection for this unit during a lightning storm, or when it is left unattended and unused for long periods of time, unplug it from the wall outlet and disconnect the antenna or cable system. This will prevent damage to the unit due to lightning and power line surges.

14 DISC TRAY

Keep your fingers well clear of the disc as it is closing. It may cause serious personal injury.

15 OVERLOADING

Do not overload wall outlets of extension cords as this can result in a risk of fire or electric shock.

16 OBJECT AND LIQUID ENTRY

Never push objects of any kind into this unit through openings as they may touch dangerous voltage points or "short-out" parts that could result in a fire or electric shock. Never spill liquid of any kind on the unit.

17 BURDEN

Do not place a heavy object on or step on the product. The object may fall, causing serious personal injury and serious damage to the product.

18 DISC

Do not use a cracked, deformed or repaired disc. These discs are easily broken and may cause serious personal injury and product malfunction.

19 SERVICING

Do not attempt to service this unit yourself as opening or removing covers may expose you to dangerous voltage or other hazards. Refer all servicing to qualified service personnel.

20 DAMAGE REQUIRING SERVICE

Unplug this unit from the wall outlet and refer servicing to qualified service personnel under the following conditions.

- When the power-supply cord or plug is damaged.
- If liquid has been spilled, or objects have fallen into the unit.
- If the unit has been exposed to rain or water.
- If the unit does not operate normally by following the operating instructions. Adjust only

those controls that are covered by the operating instructions. Improper adjustment of other controls may result in damage and will often require extensive work by a qualified technician to restore the unit to its normal operation.

E. If the unit has been dropped or the cabinet has been damaged.

F. When the unit exhibits a distinct change in performance-this indicates a need for service.

21 REPLACEMENT PARTS

When replacement parts are required, have the service technician verify that the replacements he uses have the same safety characteristics as the original parts. Use of replacements specified by the unit manufacturer can prevent fire, electric shock, or other hazards.

22 SAFETY CHECK

Upon completion of any service or repairs to this unit, ask the service technician to perform safety checks recommended by the manufacturer to determine that the unit is in safe operating condition.

23 WALL OR CEILING MOUNTING

The product should be mounted to a wall or ceiling only as recommended by the manufacturer.

24 HEAT

The product should be situated away from heat sources such as radiators, heat registers, stoves, or other products (including amplifiers) that produce heat.

25 To prevent battery electrolyte leakage, which may result in injury and damage to the unit or other objects, observe the following precautions:

- All batteries must be installed with the proper polarity.
- Do not mix new with old or used batteries.
- Only use batteries of the same type and brand.
- Remove the batteries when they are not to be used for a long period time.
- When the batteries have become discharged, they must be disposed of in a safe manner which complies with all applicable laws.

Advantages of This Product Are

- DVD, VCD, CD, CD-R(MP3), CD-RW, VHS
- Watching DVD for recording broadcast
- Integrated remote control (VCR, DVD)
- VISS function
- Multiplex sound playback/record
- High Sound Quality of 6 head Hi-Fi
- Simple record function
- MP3/JPEG file playback function (CD-R disc having records of MP3/JPEG files)
- Function to play DivX files (disc recorded with the .avi, divx format.)
(Some of the discs may not be played according to a DivX version.)
- Screensaver function (DVD)
- 3D sound (3D sound effect using 2 speakers)
- High bit/High sampling with 108MHz/12-bit Video Encoder.
- High bit/High sampling with Built-In Audio DAC.
- Coaxial digital Audio output (PCM, Dolby Digital, dts)
You can enjoy high-level digital audio by connecting with amp embedded with Dolby Digital / dts decoder.
- Built-in Dolby Digital decoder (DVD)
- Analog audio 2-channels output for DOWNMIX (x1)
- Composite video output (x1)
- Slow Forward / Reverse playback (DVD)
- Fast Forward / Reverse playback
- Search of title, chapter, and time in DVD disc, and search of time and track time in VCD.
- Various TV aspect (DVD)
4:3 for Pan and Scan, 4:3 for Letter Box, and 16:9 for Wide
- Repeat playback (title, chapter, and part for DVD/ track, disc, and part for VCD/CD)
- Selective Play (DVD/VCD/CD)
You can select and play the desired title / chapter of DVD and track of Video CD/CD in STOP mode.
- 5 languages OSD (On Screen Display) function (DVD)
You can select and display OSD in 5 languages.
- Parental Lock function (DVD)
This function can prevent playback of software that may be unsuitable for children.
- Multi Audio function (DVD)
The audio soundtrack can be heard in up to 12 languages. In the case of SVCD or VCD, it depends on the disc. (The number of audio languages depends on the software.)
- Multi Subtitle function (DVD)
The subtitle can be seen in up to 32 languages. In the case of SVCD or VCD, it depends on the disc. (The number of subtitle languages depends on the software.)
- Multi Angle function (DVD)
This function allows you to choose the viewing angle of scenes which were shot from a number of different angles. (The number of angles depends on the software.)
- Screen zoom function (DVD/VCD)

Read Carefully before Using

Cautions in use of DVD-Video player are described below.

Please read carefully before using a DVD-Video player.

- ✓ **Installation place and handling**
 - When you place this player near other devices, they may affect poorly together.
 - When you place DVD-Video player and TV in the upper and lower sides, it may cause flickering of pictures or failure (tape is not ejected).
 - When you place this player near strong magnetic materials, it may affect image or voice poorly or damage recording.
 - Do not spill volatile liquids like insect spray over the player. Do not leave rubber or plastic products in contact with the player for a long time. They will cause deterioration or paint peel-off.
- ✓ **Not in use**
 - When the unit is not in use, be sure to remove the disc or tape and turn off the power.
 - If you do not use the unit for a long period, remove batteries in remote control to prevent leakage.
 - In case you don't use the unit for a long time, the unit may not function properly in the future. Turn on and use the player occasionally.
- ✓ **Moving**
 - Repack the unit as it was originally packed at the factory. Alternatively, pack this product with towel not to be damaged.
 - Eject any videotape.
- ✓ **Cleaning**
 - Dust off dirt in cabinet or control panel part smoothly with a soft cloth.
 - For heavy dirt, soak the cloth in a weak detergent solution, wring it well and wipe. Use a dry cloth to wipe it out.
 - Follow instructions in using chemical cleaners.
 - Do not use any type of solvent such as gasoline or benzene, as they may cause deterioration or paint peel-off.
- ✓ **Checking**
 - Video is a high precision device. To obtain a clear screen, we recommend regular inspection
- and maintenance every 1,000 hours of use by technical engineers.
 - For checking, contact your dealer or your nearest service center.
- ✓ **Checking and Replacement of Antenna**
 - Antenna is subject to change in its direction or damage by wind and rain. For clean screen, contact and consult your nearest service center about checking and replacement.
- ✓ **In recording important screen**
 - Be sure to record the screen and check whether recording is performed properly. We beg you to understand compensation of recording if recording is not performed by badness of used tape or video.
- ✓ **Copyright**
 - Do not use your recordings without permission of a copyrighter except personal usage.
- ✓ **Tape and Disc Handling**
 - Do not use any tape and disc below. Damage of video head or cut/coiling of tape may cause failure.
 - Tape with mold
 - Tape or disc stained with juice or attachments
 - Tape having breakage connection
 - Disassembled tape
 - Disc with severe scratch
 - Moisture condensation may occur in tape. Moisture condensation damages the tape. Please use the tape after the moisture condensation is disappeared.
 - After use, store tape vertically in a case to prevent loose.
 - Do not store the following places.
 - High temperature and humidity
 - Subject generation of mold
 - Subject to direct sunlight
 - Much dirt or dust
 - Near strong magnetic materials such as speaker
- ✓ **Video head cleaning**
 - Video head cleaning is needed when the playback picture becomes unclear. Use an equivalent high quality chemical non-abrasive head cleaning tape or have them cleaned professionally.

Identification of Controls

Main body (front panel)

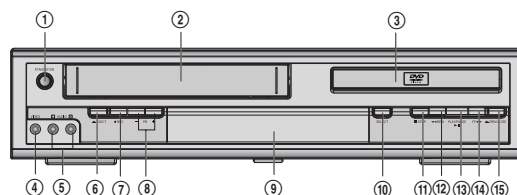

- ① **POWER (STANDBY/ON) button**
Use to power the device on/off if AC power supply is connected.
- ② **Place to insert videotape**
- ③ **Disc tray**
- ④ **VIDEO INPUT jack**
- ⑤ **AUDIO INPUT jack**
- ⑥ **EJECT button**
- ⑦ **RECORD button**
- ⑧ **PR +/- (Programme Down/Up) button**
- ⑨ **Operation Display Window**
Display operation of device. For more information, see "Operation Display Window" as next page.
- ⑩ **SELECT button**
Use to change DVD mode to VCR mode, and vice versa.
- ⑪ **STOP button**
Use to stop playing.
- ⑫ **REWIND button**
Use to rewind currently being played videotape or disc; or to playback back rapidly.
- ⑬ **Playback/PAUSE button**
Playback videotape or disc. Press this button to pause a screen.
- ⑭ **FAST FORWARD button**
Use to wind currently being played videotape or disc; or to playback rapidly.
- ⑮ **OPEN/CLOSE Tray button**

Identification of Controls

Operation Display Window



- RECORDING MODE -

	Timer Recording Standby
	Timer Recording Error
	Recording in Progress
	Timer Recording in Progress
	Recording Pause

- DVD OPERATION -

	DVD playback		VCR playback
	Fast playback		Fast forward
	Fast reverse playback		Rewinding
	Slow playback		Fast playback (CUE)
	Pause picture		Fast reverse playback (REVIEW)
			Slow playback
			Still picture
			Stop
			Child Lock

Identification of Controls

Main body (Rear Panel)

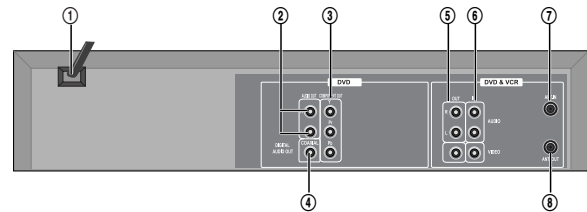

- ① POWER CORD
It is a jack for supplying power to the unit. Connect to outlet in a wall.
- ② AUDIO OUTPUT Jack
- ③ COMPONENT OUTPUT Jack
- ④ DIGITAL OUTPUT (COAXIAL) Jack
To enjoy sound quality of theater level in home, connect this jack with amp or unit embedded with digital audio decoder.
- ⑤ A/V OUTPUT Jack
- ⑥ A/V INPUT Jack
- ⑦ Connection to ANTENNA Cable
- ⑧ Connection to TV

Identification of Controls

Accessories

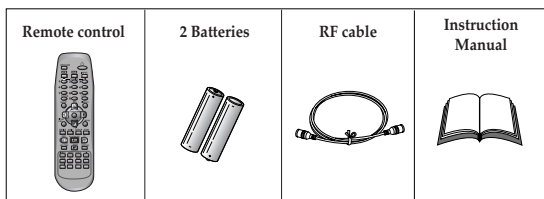

• To purchase accessories or not supplied parts additionally, contact your nearest dealer or service center. But, instruction manual is not sold additionally.

Instructions in using REMOTE

- Operate remote control within 7m from the unit.
- Do not press 2(two) buttons at the same time.
- Do not light up sending and receiving part of remote control.
- Do not keep in the place with much dust and humidity.

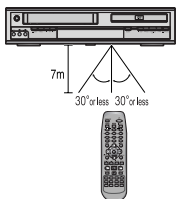

✓ Remote control battery installation

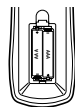

Two "AAA" batteries (supplied).

Detach the battery cover on the rear of the remote control, and insert two AAA batteries with the + and - ends aligned correctly.

Remote Control

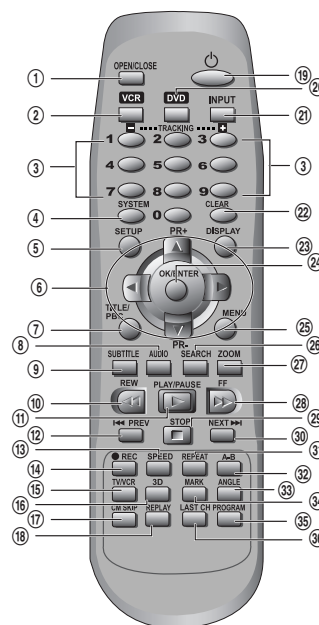

- 1 [DVD] OPEN/CLOSE button, [VCR] EJECT button
- 2 VCR SELECT button
- 3 [DVD, VCR] NUMBER button, [VCR] TRACKING +/- button
- 4 SYSTEM button [VCR] ~ This button is not available for this set [DVD] Activates Progressive Scan button
- 5 SETUP button
- 6 [DVD, VCR] MOVE/SELECT in OSD, [VCR] Channel Up/Down button
- 7 [DVD] TITLE /PBC button
- 8 [DVD] AUDIO LANGUAGE Select, [VCR] AUDIO Select button
- 9 [DVD] SUBTITLE Select button
- 10 REVERSE SEARCH button
- 11 PLAY/PAUSE button
- 12 [DVD] PREVIOUS button (move into a previous chapter or track)
- 13 [VCR] Record SPEED button
- 14 [VCR] Record button
- 15 [VCR] TV/VCR button
- 16 [DVD] 3D button
- 17 [VCR] CM SKIP
- 18 [VCR] Replay button
- 19 POWER button
- 20 DVD SELECT button
- 21 [VCR] INPUT Selection button
- 22 CLEAR button
- 23 [DVD, VCR] OSD DISPLAY button
- 24 OK/ENTER button
- 25 [DVD] MENU button
- 26 [DVD] Chapter/Title/Time SEARCH button
- 27 [DVD] ZOOM button
- 28 FORWARD SEARCH button
- 29 STOP button
- 30 [DVD] NEXT button (Move into a next chapter or track), [VCR] Frame Advance button in pause mode
- 31 [DVD] REPEAT Playback button
- 32 [DVD] REPEAT a defined period from A to B button
- 33 [DVD] ANGLE button
- 34 [DVD] MARK button
- 35 [DVD, VCR] PROGRAM button
- 36 [VCR] LAST CHANNEL button (If you move channels using the [PR+]/[PR-] button, return to the previous TV channel which was being watched)

Child Lock !

Press the power [] button of the remote for about 5 seconds. No buttons of front panel can be operated now and Lock indicator ("SAFE") will be displayed on window display. To release child lock, press any button of the remote control.

POWER ON

Player will be POWER ON if any button of the remote control is pressed.

Connecting up your player with RF lead

■ Before you start, unplug all the equipment from the mains supply.

(Option 1) - How to connect with RF lead

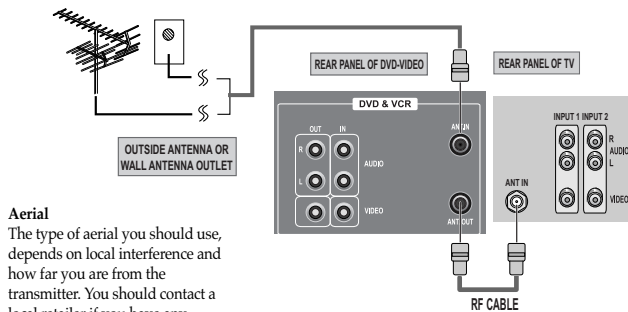

Aerial

The type of aerial you should use, depends on local interference and how far you are from the transmitter. You should contact a local retailer if you have any questions about your aerial.

- 1 Remove circular cable (RF cable) (surplus cable) plugged in "ANT.IN" jack in rear panel of TV. Connect the cable to "ANT" jack in rear panel of DVD-Video.
- 2 Connect TV to DVD-Video. Connect "TV" jack in DVD-Video with "ANT.IN" jack in TV with RF cable.

In option (1) you need to tune your television to the player so you can see the picture from the player. When it is on the player generates a signal on UHF transmission channel 52, but this might change after tuning in the stations with 'AUTO-SEARCH'. See the 'Check it out' box on page 18. See your television manual for how to tune in a new channel.

Connecting up your player with RF lead

■ Before you start, unplug all the equipment from the mains supply.

(Option 2) - How to Connect with Audio/Video jack

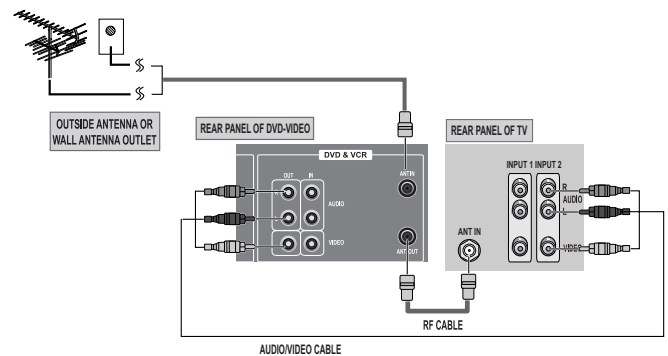

3 (If there is AUDIO/VIDEO INPUT jack in TV)

Connect VIDEO OUT jack in DVD-Video to VIDEO IN jack in TV, and AUDIO OUT jack in DVD-Video to AUDIO IN jack in TV with connecting cable of Audio/Video jack.

Select VCR mode by pressing TV/INPUT button in TV, you can view more clear screen and sound than connection with RF cable only.

- VHF: 2 ~13 channels of TV
- UHF: 14~69 channels of TV
- CATV: Broadcasting is transmitted with cable from broadcasting station by contract with the station and consumers. It does not need any antenna.
- In/Out jack in Audio/Video terminal:
 - In : A jack used to receive signal required in this unit from other units.
 - Out : A jack used to send signal of this unit to other units.
- Connect with Audio/Video terminal, you can enjoy more clear video and audio. (Use INPUT button in this REMOTE to select video mode.)

Connecting with Other VCR or Camcorder

Connecting with Other VCR or Camcorder

How to Connect with Jack in Front Panel

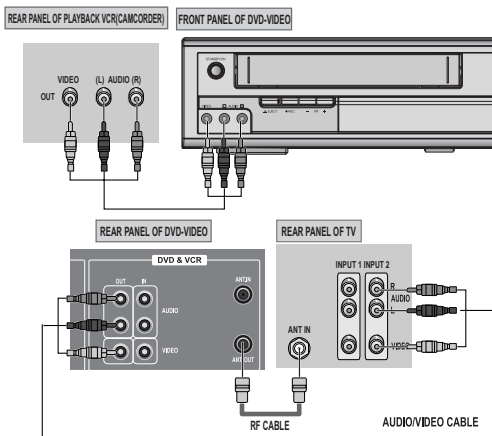

- 1 Connect AUDIO/VIDEO OUT jack in Camcorder(or playback video) to AUDIO/VIDEO IN jack in rear panel (or front panel) of DVD-Video with connecting cable.
- 2 Connect "ANT. IN" jack in TV to "TV" jack in DVD-Video with RF cable.
- 3 To record contents of camcorder or playback video with DVD-Video, insert recording tape attached recording tab in DVD-Video.

How to Copy(Edit) Tape with Other VCR or Camcorder

- 1 Turn on DVD-Video.
- 2 Press [INPUT] button of remote control and adjust DVD-Video to display "AV" or "AV.F" in TV screen.
- 3 Press [PLAY] button in Camcorder or playback video.
- 4 Press [REC] button in DVD-Video if you want to record contents of camcorder or playback video.
- 5 Press [Pause] button in DVD-Video when unnecessary or undesired scene is displayed in recording.
(Caution) Recording is released automatically after 5 minutes since pressing [PAUSE] button. Press [REC] button if you want to record again.

How to Connect with Jack in Rear Panel

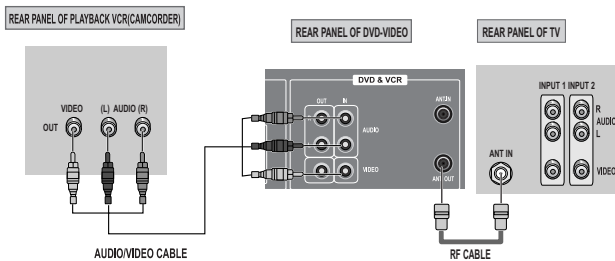

How to Playback Chapter Photographed by Camcorder

- 1 Turn DVD-Video on.
- 2 Press [INPUT] button of remote control and adjust DVD-Video to display "AV" or "AV.F" in TV screen.
- 3 Insert tape in camcorder and playback it.

Connecting with Audio

How to Connect with Stereo Unit such as Audio

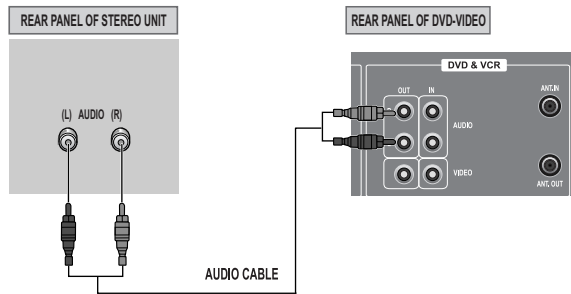

- 1 Connect Audio jack. Connect AUDIO OUT in rear panel of DVD-Video to IN jack of stereo sound unit.
- 2 For Input Select in stereo unit, Select "External Input" connected with DVD-Video.
- 3 Playback DVD disc or Hi-Fi videotape, you can hear sound in speaker of stereo unit.

Connecting to a television with Component jack and a Dolby Digital Amp.

- Use in COMPONENT In jack attached in TV or amp supporting Dolby Digital.

How to Connect

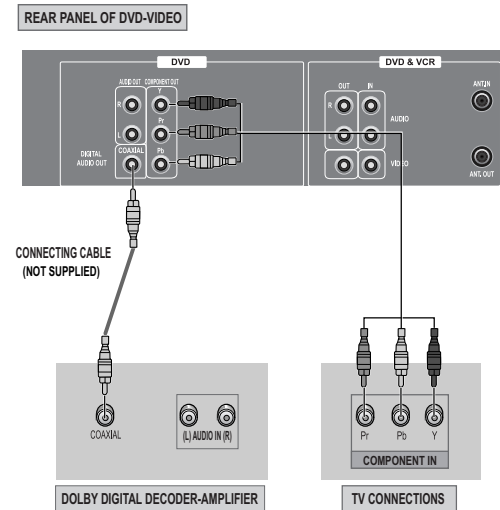

Manufactured under license from Dolby Laboratories.

"Dolby" and the double-D symbol are registered trademarks of Dolby Laboratories.

"DTS" and "DTS Digital Out" are trademarks of Digital Theater Systems, Inc.

Initial Installation

- Switch the TV on.
- You can also start "AUTO SEARCH" in the SETUP "PR PRESET" → "AUTO SEARCH".
- To tune in new stations (manual tuning) and to enter station names see page 27-28.

Setting up the player

CHECK IT!

- If you don't see the menu picture below after you press the menu button it may be because you don't use a RCA cable and you need to tune the television to the player (see 'Connecting your player through RF lead' on page 12). Normally a new player outputs a signal via the RF lead on transmission channel 52. Search for the menu picture with the channel tuning function of your TV set (see its user manual). Some televisions allow you to key in the transmission channel number in their tuning set-up menu.
- In case there will be interference problems with other transmission channels when the player outputs a signal on transmission channel 52, the AUTO SEARCH process usually recommends an alternative, as in step 4.
- There is another way of setting RF output channel, if needed please see 'Connections and Assembling on page 35'. It does not apply to models which do not generate the RF output signal.

1 Press on the remote control and RF52 will be displayed on the front of your player.
Select a free channel on your TV and manual tune the channel until the blue screen as shown in step 2 appears. Refer to the TV manual for more details.

2 You should see this picture the first time you switch on the TV and player.
Select the wanted language with **PR+** or **PR-** button. Press **OK** to confirm.

3 **OK for "AUTO SEARCH"!**
"AUTO SEARCH" tunes in all the stations you can receive in your country.

4 If the clock has not been set, the clock setting screen will appear.
Please see "Setting time and date" on page 20.

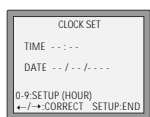
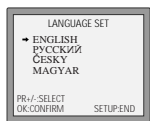

Initial Installation

5 If other stations are positioned on near the current RF OUTPUT CH, the guide message appears automatically.

The player recommends the optimal RF OUTPUT CH number automatically.

6 Press the [OK] button to confirm the recommended RF channel.

Should you wish the stations to have the same numbers as those used on the TV, follow the instructions in "Sorting programme locations" on page 29.

Else ...
exit the basic installation function and enjoy your player.

- If the signal from the player is coming into the TV through the RF lead, the picture will disappear when you press **OK** at step 7. You will need to re-tune your television to the new UHF transmission channel.

7 Should you wish the stations to have the same numbers as those used on the TV, follow the instructions in "Sorting programme locations" on page 29.

Else ...
Press the **SETUP** button to exit the set-up menu and enjoy your player

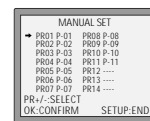
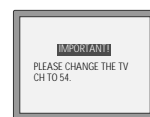
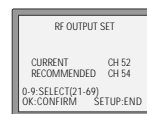

Up [PR+], down [PR-], OK and 'confirm'

- Notice the on-screen prompts which the video recorder generates to tell you which button to press. In general the up and down 'navigation' buttons select or highlight something and the **OK** button confirms it.
- [PR+] and [PR-] are the same buttons as 'up' and 'down'.
- In the DVD section it is usually the left and right buttons which 'select'.

Setting time and date

Setting time and date

- Press [VCR] button on the remote control to change into VCR Mode and follow the procedure below.

1 Call the player's "SETUP", choose "VCR SETUP", then "CLOCK SET".

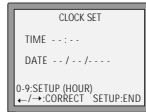

2 Move to the position you want to change and type in the new values. Wait a few seconds after typing a one-digit number.

Store with [OK] button and exit with [SETUP] button.



OSD ON & OFF

OSD (On Screen Display) ON & OFF

This player is set to "OSD (On Screen Display) ON" mode before shipping and you can change it to OFF mode.

1 Call the player's "SETUP".



2 Choose "VCR SETUP". And press the [OK] button.



3 Select "OSD ON/OFF". If you want OSD OFF mode, select it and press [OK] button to confirm. Then OSD characters are not displayed in the normal picture.

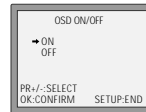

Output Select

To Select DVD

Press [DVD] button.

If DVD mode is correctly selected, DVD on the operation display window is lit. Then, REMOTE button works as DVD function. Press the [DVD] button, then the mode of DVD-Video Player becomes to the OPERATION mode.



To Select VCR

Press [VCR] button.

If VCR mode is correctly selected, DVD on the operation display window goes out. Then, REMOTE button works as VCR function. Press the [VCR] button, then it becomes to the VCR OPERATION mode.





To Select Watch Modes or External Input

Press [INPUT] button.





When you press [INPUT] button, BROADCASTING RECEPTION and EXTERNAL INPUT is selected. But, it is not operated in PLAY, REC and DVD mode.

DVD Playback





- 1 Press [] button to power on.
Press [DVD] button of REMOTE to change into DVD mode.
- 2 Press [OPEN/CLOSE] button to open the disc tray.
Place a disc firmly on the disc tray, making its label look upward.
- 3 Insert the disc and press [OPEN/CLOSE] button to close the tray.
The disc tray is closed and after checking the disc's condition, Playback or Stop function starts to operate.
- 4 To playback it, press [PLAY/PAUSE] button.
 - In the case of DVD,
DVD menus and titles are displayed on TV screen.
 - In the case of S-VCD and VCD2.0
the menus are displayed on TV screen and it is converted into PBC(Playback Control) mode.
 - In the case of CD, VCD1.1, MP3, DivX and JPG
the disc plays.
- 5 To stop it, press [] button.
If you want to stop playback, press [STOP] button.
- 6 Press [OPEN/CLOSE] button to remove the disc.

Various Playback Methods





- If you want fast forward (or reverse) playback, press [] or [] button in Playback mode. You can watch fast playing (reverse) screen.
* This reverse playback can be unavailable for certain DVD.
- If you want slow (or reverse) playback, press [] or [] button in Pause mode. You can watch the desired screen in the slow forward (reverse) playback.
* For the case of VCD and DivX, this reverse slow playback function is unavailable. The  mark will appear.
- If you want still picture, press [PAUSE] button in Playback mode. You can watch the desired screen in Pause status.

VCR Playback



- 1 Press [] button to power on.
Press [VCR] button of remote control to change into VCR mode.
- 2 Insert the desired tape.
- 3 If you want to playback it, press [PLAY/PAUSE] button.
When the operational status is flickering or poor, adjust it with [TRACKING +/-] button.
- 4 To stop it, press [] button.
If you want to stop playback, press [STOP] button.
- 5 Press [EJECT] button in the front part or [OPEN/CLOSE] button on remote control to remove the tape.

Various Playback Methods

- If you want fast forward (or reverse) playback, press [] or [] button in Playback mode. You can watch fast playing (rewinding) screen.
* NOTE: You might see no color noise band when you fast forward (or reverse) playback the tape which is recorded in LP mode.
- If you want Still picture, press [PLAY/PAUSE] in Playback mode. You can watch the desired screen in pause status.
- If you want slow-motion playback, press [] button in Pause mode. You can watch the desired screen in the slow forward playback.
* NOTE: VCR doesn't have Slow Reverse Playback function.
- If you want to watch a series of screens one by one, (FRAME ADVANCE) press [NEXT ] button in Pause mode. Each time you press this button, the picture advances one frame.
- If you press [REPLAY] button in playback mode, the player quickly rewinds 15 seconds of the tape and plays it.
- If you press [CM SKIP] button in playback mode, the player quickly skips 30 seconds of the tape and plays it.

To Adjust Display

This product includes automatic Tracking function and enables users to enjoy clear picture without an additional operation. Provided that the following problems can be solved by the manual adjustment, which improves display quality. (During automatic display adjustment, "Adjusting Display" are displayed on TV screen.)

- If the screen is poor in Playback mode,
 - If noises occur in the upper or lower part of screen in slow playback mode,
 - If paused picture vibrates up and down.
- Use [TRACKING +/-] buttons of remote control to adjust the display suitable for watching.



If the product, which has a auto-detector, detects a contaminated head(s), it shows the conditions to notice the contamination on screen.

* In case of the notice on screen, please rub the heads with a head-cleaver followed by "How to use a head-cleaver".

Recording

To Record With VCR





- 1 Press [] button to power on.
 - Press [VCR] button of remote control to change into VCR mode.
- 2 Insert a recordable tape.
Insert a tape with recording tab.
- 3 With [CHANNEL], [NUMBER] and [INPUT] buttons, select the desired broadcasting channel or external input unit to record.
- 4 Select the desired speed (SP or LP) with [SPEED] button.
- 5 Press [REC] button.
Then, it starts recording.
- 6 If you want to pause recording, press [PAUSE] button.
After pressing [PAUSE] button, if the pause status continues for five minutes, the recording is released automatically.
- 7 To exit recording, press [STOP] button.

To Enjoy a TV Channel or DVD during recording

- 1 If you want to playback DVD during recording with video, insert a DVD disc.
Place the desired DVD disc on DVD tray, press [DVD] button to convert OUTPUT into DVD mode and press [PLAY] button. Then, you can watch DVD.
- 2 If you want to watch a TV channel during DVD recording with video, press [VCR] button to convert OUTPUT into VCR mode and press [PR+/-] button.
Then, you can watch a TV channel.

To Copy From DVD To Videotape

- 1 Insert the desired DVD disc.
When it is a DVD disc with copy protect function, you can't copy it.
Insert a recordable tape.
- 2 Press [REC] button during playing of DVD.
DVD plays and VCR starts recording.
- 3 If you press STOP [] button in DVD mode, DVD and VCR will stop at the same time.
If you press STOP [] button in VCR mode, VCR stops to record and DVD continues to play.

"This product incorporates copyright protection technology that is protected by U.S. patents and other intellectual property rights. Use of this copyright protection technology must be authorized by Macrovision, and is intended for home and other limited viewing uses only unless otherwise authorized by Macrovision. Reverse engineering or disassembly is prohibited."

CHECK IT!

* Only record in interlaced mode

This DVD+VCR can only record in interlaced mode.
To get proper picture, press [SYSTEM] to "INTERLACED" before recording.

Recording

One Touch timer Recording (OTR)

- When your urgent business happens suddenly in watching TV or you want to record the current TV program for the desired time, follow the procedures below.

- First, follow the steps 1 to 4 in "Recording With VCR".
- Press [REC] button as much as you want. See the "Recording Times Table" below.

Once	continuous recording until you press STOP button
Twice	recording for 30 mins from current time
3 (times)	recording for 1 hour
⋮	
21	recording for 10 hours
22	returning to the status of Once Press
- To stop Recording mode, press [STOP] button more than 5 seconds.

Tuning in New Stations

- The TV and player are switched on.
- To see the picture from your player, press the input or AV (Audio/Video) button on the TV.

Tuning

- To complete the set-up of your video recorder when the auto set has not stored all of the channels or when you wish to store a new channel. Call the video's "SETUP", choose "PR PRESET".

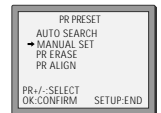

- Select "MANUAL SET".

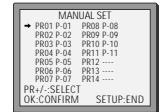

- Choose any unused location number "----" or "P-xx" ...
It's simplest to use the same location number on both the TV and video.
... and confirm.

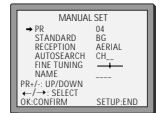

- Set the station you want:
 - the programme location number;
 - the proper broadcast system for your location (BG/DK)
 - the broadcast system you want (Aerial(CH) or Cable(CC)),
 - You can directly enter the real channel number with the [0 to 9] buttons, or search by pressing [◀▶],
 - The fine tuning you can adjust,
 - Change or create the station name.

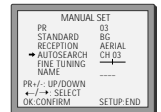

- Once you see the station you want, store it.
Tune in further stations (from step 3 onwards) or exit tuning mode.

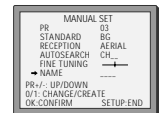

Station names

- If your player is showing no station name or is showing a station name incorrectly, you can correct this.

1 Call this menu (just see the previous page), if it isn't displayed.
Select NAME position.
Press the [0] button to change the given name.
Or press the [1] button to create the station name.

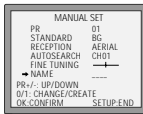

2 Either select the name from the stored list or you create the station name and enter a 4-digit name.
Change the letters with the [PR +/-] buttons, move to the next letter with the [◀/▶] buttons.

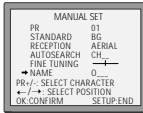

3 Store and exit.

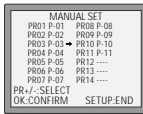

Sorting programme locations

If the location numbers used for programmes stored in your TV and player are different, you can change them on the player. To do this, move the stations to the right numbers, until they are arranged the way you want.

- 1 Call the player's "SETUP", choose "PR PRESET" then "PR ALIGN".
- 2 Select the programme to swap.
Confirm by pressing OK button.
Move the station to the desired location number.
Confirm by pressing OK button.

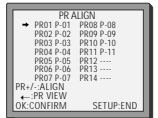

Clearing programme locations

- 1 Call the player's "SETUP", choose "PR PRESET" then "PR ERASE".
- 2 Select the station (location number) you want to clear.
Review the picture by pressing [◀] button.
Clear by pressing OK button.

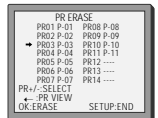

Timer Recording

- For timer recordings, clock, date, and stations must be set correctly.
- Load a cassette with its safety tab in place and with sufficient free space for the recording.

Normal timer recording

1 Press "SETUP", choose "TIMER PROGRAM". Press OK. Choose a free programme location. Press OK. You will be asked if you want to record "ONCE", "WEEKLY" or "DAILY".

Please decide and confirm with OK.

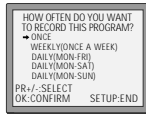

2 Type in one after the other:

- The programme location number;
- the time the broadcast starts,
- the time the broadcast ends,
- the day of the broadcast, if it is not today.
- Select LP if you wish to make a very long recording.

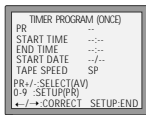

3 If you wish to make changes: Move to the position you want to change using the [◀▶] buttons. Change the setting using the [PR +/-] or [number] buttons. If all settings are ok, press [◀ or ▶], till you see "OK : CONFIRM" in the bottom line. Confirm.



Switch your player off.



- Wait a few seconds after typing a one-digit-number.
- If you have made a mistake, move to the position you want to change using the [◀▶] buttons and change the setting.
- If programme timings overlap, the machine will give a warning message. If you don't adjust the times, the machine will record the first programme completely then continue with the second one.
- If there is no sufficient free space for the recording on the cassette the video switches automatically to "LP" for double recording capacity.
- The recorder will eject cassettes which have the safety tab removed.
- The player will be powered on and record the program at the set time.
- In case the player is powered on after setting of timer recording, the player cannot record in VCR mode but can record in DVD mode.

Timer Recording

Timer Review – changing and erasing

1 Call the player's "SETUP", choose "TIMER PROGRAM".



2 Select the programming to change or erase, press OK. If you want to erase this programming press button [0].



If you wish to make changes, move to the position you want to change using the [◀ or ▶] buttons. Change the settings using the [PR +/-] buttons.

If all settings are correct, press OK to confirm the changes. Exit the menu with SETUP.

More Functions

- The counter counts in real time from the point you load the cassette. This does not have to be its beginning! The counter does not count unrecorded parts of the tape.
- If you rewind beyond the zero position, the counter counts in negative values (e.g. -0:01:15).

Clock / counter display

Each time you press [DISPLAY] button,
 1x: Time and date+current status → Time and date
 2x: Counter+current status → counter
 3x: disappear.



- If didn't wind tape (PLAY, FF, REW,...), it doesn't appear the tape remain time.

Remaining time and cassette length

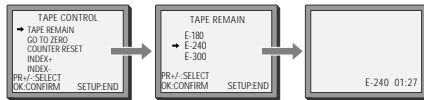

Call the player's "SETUP",
 choose "TAPE CONTROL"
 • Remaining time display is
 only possible when the
 cassette is loaded.

When you want the player to show the time remaining from the current player tape position (to find out if there is sufficient space for a recording, for example). To ensure the remaining time shown is accurate, select the length of cassette currently loaded by selecting this function until you reach the correct length.

Searching for a recorded program via index

When you record a program, the VCR places an index mark at the start of the recording.

To search for an index mark

1. Press "SETUP", choose "TAPE CONTROL"
2. Choose INDEX + to search forward, or INDEX - to search backward. The VCR will locate your index mark and will start playing the tape at the previously set index mark.

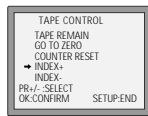

Accessing counter zero position

The player will wind to the position 0:00:00 and stop.

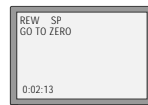

More Functions

Resetting the counter to zero

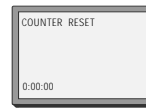

Reset the counter.

AUTO REPEAT

If you press the [PLAY] button for 5secs during stop or still mode, it goes Auto repeat mode. This player plays repeatedly the tape from the beginning to end parts.

To release this mode, press the [] button or mode operation button. (PLAY, FF, REW or STOP)

SETUP languages

Call the player's "SETUP", choose
 "VCR SETUP", then "LANGUAGE SET".

Select your language.
 Confirm.



Child lock

Press the [] button for about 5 seconds.

No buttons of front panel can be operated now and LOCK INDICATOR ("SAFE") will be displayed on window display. Keep your remote control in a safe place. To release child lock, press any button of the remote control.

Cassettes

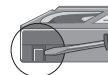

Use only good quality tape cassettes with the VHS logo.

- Keep cassettes away from excessive moisture or dust, magnetic and electrical fields (loud speakers and computer monitors, for example).
- Always wind the tape to the beginning when you have finished. Store with the full spool at the bottom and with the cassette in its cover.

You can protect your precious recordings from being wiped by breaking out the safety tab on the side of the cassette (some cassettes have a slide). Should you wish to re-use the tape after removing the tab, cover the hole with adhesive tape.

and ...

Dimmer : Your player dims its display when switched to stand-by mode.

Auto power off : Your player switches to stand-by when no tape is played and no station is received for more than 5 minutes.

More Functions

- The player machine records the complete sound signal transmitted by the TV station.
- On the mono VCR, you will hear the normal mono sound.

The Hi-Fi system

In addition to the normal mono sound track of VHS video recorders, your player machine is equipped with a high-quality Hi-Fi sound system.

This means you can enjoy

- films with excellent stereo sound
- films of full-length concerts in high quality stereo
- films with impressive Surround Sound using additional Surround equipment
- films with two dialogue modes (dual, bilingual), usually the original sound track and dubbed sound track
- VHS cassettes with Hi-Fi stereo sound and VHS cassette with normal sound

What you can listen to

During Stop, the player displays what the current station is broadcasting. When you switch to another station or the current station changes the sound mode, your player displays the programme and sound mode on screen (if not, press AUDIO).

- "STEREO" = stereo
- "BIL I / BIL II" =bilingual
- nothing= monaural sound



During Playback, the player displays what is recorded on the cassette (if not, press AUDIO).

- "Hi-Fi" = stereo/bilingual
- nothing = monaural sound



Choice of sound output

During a stereo performance (playback-"Hi-Fi" / broadcast -"STEREO"):

Hi-Fi stereo → left audio channel only → right channel only → the normal mono sound track of a Hi-Fi cassette

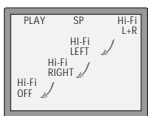

- During broadcasting a bilingual performance : Main language (original sound track) → sub-language (dubbed) → both main language and sub-language.

- For mono performances , there is no choice available.

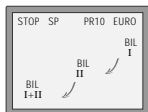

Connections and Assembling

- If you are using a RCA cable, select the AV input on the TV to see the picture from the player.
- If you are not using a RCA cable, select the button number on the TV reserved for video input to see the picture from the player.

To the TV via antenna cable (if you are not using a RCA cable)

If you are not using a RCA cable, your player can transmit pictures and sound to the TV via the coax aerial cable. Just tune the TV to the player's transmitting channel (factory set to UHF CH52). Tune the TV carefully to ensure the best pictures and sound.

- 1 Once you have carried out the steps in "Connecting up your player with RF lead" , switch on your TV. Press the [OK/ENTER] button of the player's remote control longer than 5 seconds to call the player's test picture. Tune the TV to the test picture using the channel pre-set functions of your TV as described in its manual. When you have found the test picture, store it under the button number on your TV for player input. Press the [OK/ENTER] button of the player's remote control again longer than 5 seconds to release the test picture.



- 2 If the quality of the test picture transmitted to the TV is poor due to interference caused by a station transmitting on channel 52, you can tune the player to a different transmitting channel. Find a free channel between 21 and 69 on your TV.

Call the player's "SETUP" choose "VCR SETUP" then "RF OUTPUT SET".

Type in the free channel.

Store and exit.

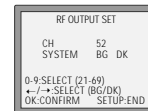

- If the quality of the test picture transmitted to the TV is poor, fine-tuning on the TV may help (refer to the TV manual).
- Without a RCA cable, you will not get stereo sound from a TV capable of stereo sound.

Connections and Assembling

Assembling

Should you wish to assemble your own film, from camcorder footage for example, use the assembly technique for smooth edit points:

- The symbol is lit in VCR mode and goes out in TV mode.
- This symbol means the cassette is in.
- This symbol means a timer recording is setting.

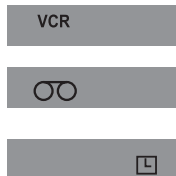

For the best results, the source cassette from which you are recording should already be playing back when you start recording.

Playing a desired scene

To skip scenes in a disc



To move to next chapter (or track), press [▶▶ NEXT] button.
The current chapter (or track) moves to the next chapter (or track).

Press [◀◀ PREV] button.
The current scene moves to the previous chapter (or track) or first scene of current chapter (or track).

Directly moving to a desired title



- Some movie discs may contain multiple titles. If the disc has a movie title menu recorded on it, the [TITLE/PBC] or [MENU] button can be used to select the movie title. Details of operation may differ depending on the disc used.
* Selecting a title may not be available on certain DVD discs.

- 1 Press the [TITLE/PBC] or [MENU] button.
A list of the titles on the disc is displayed.
* For the case of VCD disc, menu screen will appear only when the disc has PBC function and PBC ON is activated.



- 2 Press the [ENTER] button or [PLAY] button after pressing the [◀▶▲▼] button to select the desired title.
For the case of VCD disc, press the [Number] button.
The selected title now starts playing.



Repeating a defined period

DVD VCD CD MP3 DivX JPG

Each time you press [REPEAT] button in playback mode, repeat playback starts as below.

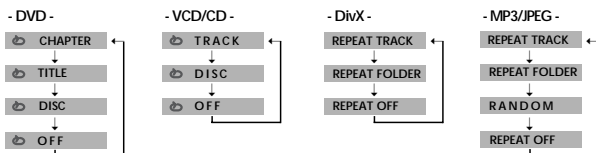

* For the case of VCD disc, repeat playback starts only in PBC OFF mode.

Repeating a defined period from A to B

■ You may repeat a defined period from A to B.

DVD VCD CD MP3 DivX

- 1 At the point where you want to start the repeat playback, press [A-] button. The right figure appears and repeat playback start position (A) is set.
- 2 At the point where you want to end the repeat playback, press [A-B] button again. The repeat playback end position (B) is set and a defined period from A to B is playback repeatedly.
- 3 To exit from repeat playback mode, press [A-B] button. It enters into Normal Playback mode.

Searching DVD with a title number, a chapter number or a time

DVD

1 Press [SEARCH] button in playback mode. It shows current disc mode.

- current title / total title
- current chapter
- current audio
- current subtitle
- current angle / total angle

- total time
- chapter time
- repeat playback mode
- time display

- 2 If you want to search with a title number, select TITLE using [▲/▼] button. Then press [ENTER] Please enter the new title number to be searched using the [NUMBER] buttons.
- 3 If you want to search with a chapter number, select CHAPTER using [▲/▼] button. Then press [ENTER] Please enter the new chapter number to be searched using the [NUMBER] buttons.
- 4 If you want to search with a total time or chapter time, select TT TIME or CH TIME using [▲/▼] button, and press [ENTER]. Please enter the new TT time to be searched using the [NUMBER] buttons. PLAY starts from the selected position.

* You can also select AUDIO, SUBTITLE, ANGLE, REPEAT and TIME DISPLAY using [SEARCH] button.

Searching VCD with a track, track time or disc time

VCD

1 Press [SEARCH] button in playback mode.
It shows current disc mode.

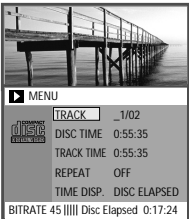

→ current track / total track
→ disc time
→ track time
→ repeat playback mode
→ time display

2 If you want to search with a track number, select TRACK using [▲/▼] button. Then press [ENTER].
Please enter the new track number to be searched using the [NUMBER] buttons.

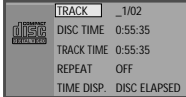

3 If you want to search with a disc time or track time, select DISC TIME or TRACK TIME using [▲/▼] button. Then press [ENTER] button.
Please enter the new time to be searched using the [NUMBER] buttons.

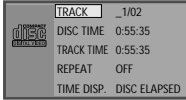

 * You can also select REPEAT and TIME DISPLAY using [SEARCH] button.

Searching CD with a track, track time or disc time

CD

1 If you want to search with a disc time, press [SEARCH] button once.
Please enter the new time to be searched using the [NUMBER] buttons.
PLAY starts from the selected position.



2 If you want to search with a track time, press [SEARCH] button twice.
Please enter the new time to be searched using the [NUMBER] buttons.
PLAY starts from the selected position.



3 If you want to search with a track number, press [SEARCH] button three times.
It shows current and total track number.
Please enter the new time to be searched using the [NUMBER] buttons.



Storing markers in memory to be viewed (listened) again

DVD VCD CD

■ Storing a MARKER in memory is similar to marking your page in a book. It allows you to quickly return to any point on the disc.

1 **Storing a marker in the memory.**
Press [MARK] during play and press [ENTER] at the starting point to be viewed (listened to) again.

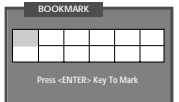

Press <ENTER> Key To Mark

2 **Recalling/Clearing a marker**
Press [MARK] during playback. Press [▲,▼,◀,▶] to select the marker to be recalled/cleared. Press [ENTER] to recall a marker. Or press [CLEAR] to clear a marker.

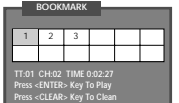

TT:01 CH:02 TIME 0:52:27
Press <ENTER> Key To Play
Press <CLEAR> Key To Clean

Confirming the current PLAYING TIME

Confirming the current playing time of DVD disc

DVD

While in playing, press [DISPLAY] button.
It shows the current playing time.

Each time you press [DISPLAY] button in playback mode, DISPLAY is change as below.

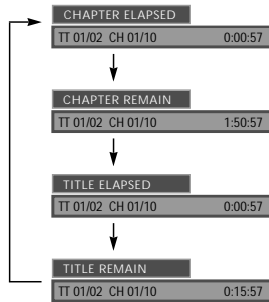

Confirming the current PLAYING TIME

Confirming the current playing time of CD, VCD, and DivX

VCD CD DivX

While in playing, press [DISPLAY] button.
It shows the current playing time.

Each time you press [DISPLAY] button in playback mode, DISPLAY is change as below.

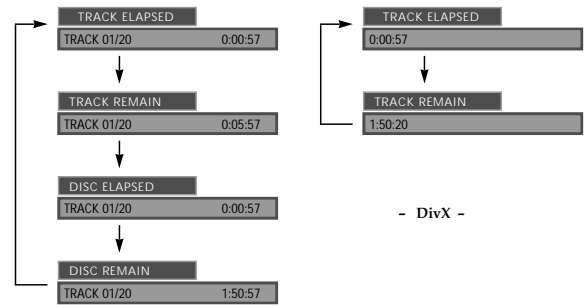

- CD, VCD -

- DivX -

Selecting an AUDIO language, SUBTITLE language and 3D AUDIO

Selecting an audio language

DVD

- The user may select an audio language and subtitle language if a disc includes Multi-language.

 A certain disc may not support audio select or subtitle select.

Keep pressing [AUDIO] button till the user's preferred language appears in playback mode.

If DVD disc includes audio information, every time the user presses [AUDIO] button, English (ENG), French (FRE), Spanish (SPA) and others appear one by one.

AUDIO 1/2 : AC3 2CH ENGLISH

Selecting a subtitle language

DVD

Keep pressing [SUBTITLE] button till the user's preferred language appears in playback mode.

If a DVD disc includes subtitle information, every time the user presses [SUBTITLE] button, English (ENG), French (FRE), Spanish (SPA), ... and OFF appear one by one.

SUBTITLE 01/02: ENGLISH

Selecting an AUDIO language, SUBTITLE language and 3D AUDIO

Selecting 3D Audio

DVD VCD CD MP3 DivX

- You can enjoy a virtual 3D sound effect from 2-channel sources.

Keep pressing [3D] button till the preferred sound effect appears.

Every time you press [3D] button, the 3D sound is change as below.

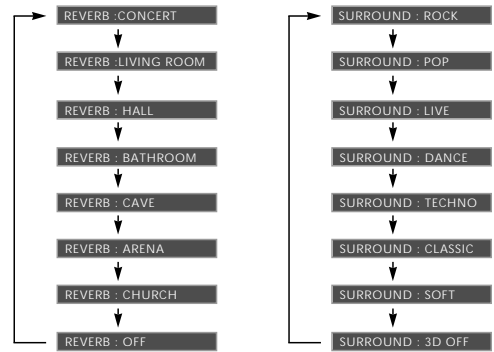

- DVD, VCD, DivX -

- CD, MP3 -

DVD Operation

Selecting ZOOM and Multi Angle

Using a zoom function

- The user can enlarge the current screen.

DVD Keep pressing [ZOOM] button till the preferred zoom appears.
VCD A magnification ratio of display is increased or decreased by one step in order upon pressing the [ZOOM] button.

DivX

- ZOOM: 2 times → 3 times → 4 times → 1/2 times → 1/3 times → 1/4 times → OFF.

A base point to be enlarged is centre and the point can be changed with the operation of [◀▶▲▼] button.



JPG Press [ZOOM] button, then press [▶▶] (increase) or [◀◀] (decrease).

- ZOOM: 50% → 75% → 100% → 125% → 150% → 200% .

[▶▶] →
 [◀◀] ←

When playing JPG, it can be displayed in various directions by using [◀▶▲▼] button.
 [◀▶]: Rotate 90 degrees to clock wise or counter clock wise.
 [▲▼]: Turn over the screen by 180 degrees horizontally or vertically.

Different Angle

DVD

- If a disc includes multi angle information, the user can watch a screen in multi angles. The function is limited to a DVD disc supporting multi angle information.

Keep pressing [ANGLE] button till the preferred angle appears.
 Every time the user presses [ANGLE] button, an angle degrees changes in a consecutive order.

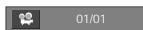

Program Playback

DVD **VCD** **CD**

- The user can watch only wanted Title/Chapters or Tracks in wanted order up to 20 events.

1 Press [PROGRAM] button in playback mode.



2 Select the number using [▲,▼,◀,▶] and press [ENTER] button.

3 Enter Title number and Chapter number (DVD), or Track number (VCD, CD) using [NUMBER] buttons.

4 Select START using [▲,▼,◀,▶] button, and press [ENTER].



About MP3, JPG and DivX® discs

About MP3, JPG and DivX® discs

Playing a disc containing MP3 or JPG files

JPG MP3

You will play a MP3 file or a JPG file recorded in disc.

- 1 Press the [OPEN/CLOSE] button to open the disc tray.
Put a MP3 or JPG disc on the disc tray with the label side up.
Press the [OPEN/CLOSE] button to close the disc tray.
It will take some time to recognize a disc and to show up the directory structure.

It will display MEDIA PLAYER.

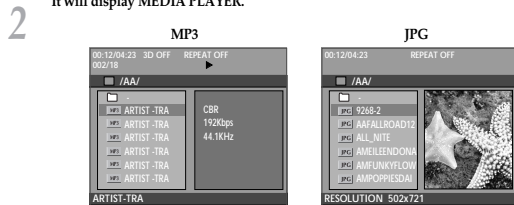

- 3 Select a file or folder to play.
Select a desired folder or file by pressing the [▲▼] button and then press on the [ENTER] button. It will select or play the file or folder selected.
 - Play or pause
It will change into Play or Pause while pressing the [PLAY/PAUSE (▶/⏸)] button.
 - SEARCH
The [SEARCH] button and select the file (MP3, JPG) or the time (MP3) you desired using the [Number] buttons.
 - STOP
The [STOP] button.
 - Pass over to a next or previous file.
 - When you press the [▶▶ NEXT] button on the remote control, it will move on the first part of a next file and start to play it. And it will continue to move on the first part of a next file and play it upon pressing the button.
 - When you press the [Previous ◀◀] button on the remote control, it will move on the first part of a previous file and start to play it. And it will continue to move on the first part of a previous file and play it upon pressing the button.

Program

- Pressing the [PROGRAM] button in MEDIA PLAYER WINDOW mode. The PROGRAM WINDOW is displayed. Select the file you want to program using the [▲▼] button, and press the [MARK] button.
- Pressing the [PROGRAM] button again, you can see the PLAYLIST. Pressing the [ENTER] button, the PROGRAM starts.

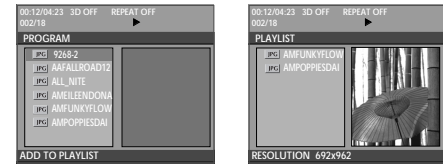

- To remove the PLAY LIST file, select the file you want to remove and press the [MARK] button.
- If you press the [PROGRAM] button while the JPG file is playing, you can change the state the TRANSITION EFFECT.

Each time you press [PROGRAM] button in playback mode, TRANSITION EFFECT is change as below.

- NONE → WIPE TOP → WIPE BOTTOM → -- → WINDOW V → WIPE FROM EDGE TO CENTER → MOVE IN FROM TOP → NONE.

Thumbnail mode

- Pressing the [MENU] button in JPG playback mode, the THUMBNAIL mode is displayed.

Slide Show : If you select Slide Show, the Slide Shows is starting.

Menu : If you select Menu, you can see the REMOTE KEY FUNCTION window.

Combination Play

You can enjoy a slide show while listening to MP3 music files.

1. Select the MP3 file and press [ENTER].
2. Select the JPG file using the [▲▼] button and press the [ENTER] button.

The MP3 file you selected continues to be played back during the JPG slide show.



■ **Recognizing range for a MP3 disc is stated below.**

- It may break of a sound while playing for a file in which it was recorded with a variable bit rate(VBR) from low bit rate to high bit rate (Ex.:64~256kbps) in itself.
- A file name must be composed with figures and the extension must be MP3.
- The Maximum recognizing number of files is 647.

■ **Recognizing range for a JPG disc is stated below.**

- File name is ****.jpg which is composed with characters and figures.
- Some of JPG files may become not only slow to play but also impossible to play since the capacities are too large.
- The state or saving method of a disc may cause not to play it.

Cautions upon a use of MP3, JPG disc.

- Due to many different recording formats which exist for CD-RW-discs, we cannot guarantee that each CD-RW can be played with this unit.
- The CD-R must be recorded with the standard format because it can not be played back according to the recording format.
- The CD-R should be written using the 'disc at once' method.
- The disc which is made with ISO 9660 format can be played back.

Playing a disc containing DivX® files

DivX

1

Insert a DivX disc.

Press the [OPEN / CLOSE] button and then it will open the disc compartment.
Insert a DivX disc into the disc compartment while putting the playing side downward and then it will display MEDIA PLAYER.

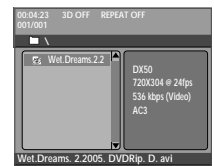

2

After selecting a desired folder by pressing the [▲▼] button, press the [ENTER] button.

3

After selecting a desired track by pressing the [▲▼] button, press the [PLAY/PAUSE (▶/⏸)] button or the [ENTER] button.

4

Press the [■] button when you want to stop playing.

- It will return to the display of MEDIA PLAYER.



- In order to recognize the subtitle file automatically, DivX file name and Subtitle file name must be same.

Ex) DivX file name : ETHE ADVENTURE.avi
Subtitle file name : ETHE ADVENTURE.sub



- DivX® video technology, often called the "MP3 of video", enables large video files like DVDs or home videos to be converted to a fraction of the size.

- Types of playable DivX files : ".avi", ".divx"
- Types of playable Codec formats : DivX3.xx, DivX 4.xx, DivX 5.xx, XviD, MP43, 3vxx
- It may not be played according to a type of DivX files, a recording method, or a disc state. (The device was authenticated for DivX files from the DivX Networks, Inc. and it is available for playing a normal DivX file but may be unavailable for playing the DivX files that have been manufactured with an illegal or abnormal Codec.)
- When the image / sound structure of a recorded file have not been undergone the interleave, it will output either the image or the sound.

About MP3, JPG and DivX® discs

- When the frame number per a second is more than 30, it may not play it normally.
- It will not support a DivX file coded with 'dts'.
- It will not support some GMC or Q-Pel(Quarter Pixel).
- It will be available to play a file with a resolution size will be below 720 x 480 (width x length) pixels only.
- If it has a code unable to display, it displays "Resolution NOT supported", "Video Codec NOT Supported" or "Audio Codec NOT Supported".
- A file name of DivX subtitles must be made with up to English 90 characters only.
- A file of DivX subtitles only supports a file named with the extensions of .smi, .srt, .sub or .txt.

- DivX, DivX Certified and associated logos are trademarks of DivXNetworks, Inc. and are used under license.

Displaying menus in a disc

To display menus in a disc

DVD VCD2.0

- If a disc includes menus, the user may use them.

1

Press [MENU] button.

- In case of a DVD disc, it shows menus in the disc. Also they are different according to discs.
- If it is a VCD2.0, select PBC ON mode by pressing [TITLE/PBC] button.
* CD and VCD1.1 do not support the function.

2

If it is a DVD disc, move a cursor to a relative item with arrow buttons of [◀ ▶▲▼] button and select one with [ENTER] button or [PLAY] button.

Progressive Scan Mode

Selecting SCAN MODE

While in DISC STOP mode, press the [SYSTEM] button .

Each time you press [SYSTEM] button, the SCAN MODE changes as follows: INTERLACED › PROGRESSIVE › INTERLACED › PROGRESSIVE.

* If SCAN MODE is set to "INTERLACED", connect Y/Pb/Pr on the DVD+VCR to the INTERLACED input on your TV.

If SCAN MODE is set to "PROGRESSIVE", connect Y/Pb/Pr on the DVD+VCR to the PROGRESSIVE SCAN input on your TV.

Language Setup

■ A user can set OSD language, Audio, Subtitle and Disc Menu.

1 While STOP, press [SETUP] button.

 "OSD" means "On Screen Display".

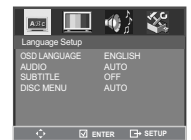

2 Selecting a OSD language. Select a OSD language to be displayed on DVD menus with [ENTER].

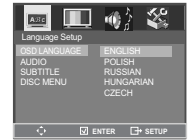

3 Selecting Audio language. Set your preferred audio language with [ENTER]. If the audio language is set and recorded on the DISC, it is automatically played in the set language every time it is played.

 In case a disc does not include setting languages information, the selected language does not appear.



OTHERS -----: Another language can be selected. You can input 4-digit language code. Refer to the language codes on next page. Press [CLEAR] if an incorrect language code is entered.

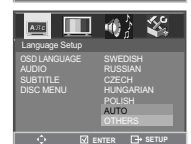

4 Selecting Subtitle language. Set your preferred subtitle with [ENTER]. If the subtitle language is set and recorded on the DISC, it is automatically played in the set language every time it is played.

OTHERS -----: Another language can be selected. You can input 4-digit language code. Refer to the language codes on next page. Press [CLEAR] if an incorrect language code is entered.

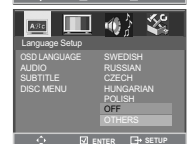

Setup

Language Setup

- 5** **Selecting Disc Menu language.**
Set your preferred DISC MENU language with [ENTER]. If the DISC MENU language is set and recorded on the DISC, it is automatically played in the set language every time it is played.

OTHERS - - - - : Another language can be selected. You can input 4-digit language code. Refer to the language codes. Press [CLEAR] if an incorrect language code is entered.



Table of language and Their Abbreviations

Enter the appropriate code number for the initial settings "AUDIO", "SUBTITLE" and/or "DISC MENU".

Code Language	Code Language	Code Language	Code Language	Code Language
6565 Afar	6983 Spanish	7473 Yiddish	7789 Burmese	8385 Sundanese
6566 Abkhazian	6984 Estonian	7487 Javanese	7865 Nauru	8386 Swedish
6570 Afrikaans	6985 Basque	7565 Georgian	7869 Nepali	8387 Swahili
6571 Ameharic	7065 Persian	7575 Kazakh	7876 Dutch	8465 Tamil
6582 Arabic	7073 Finnish	7576 Greenlandic	7879 Norwegian	8469 Telugu
6583 Assamese	7074 Fiji	7577 Cambodian	7982 Oriya	8471 Tajik
6588 Aymara	7079 Faroese	7578 Kannada	8065 Panjabi	8472 Thai
6590 Azerbaijani	7082 French	7579 Korean	8076 Polish	8473 Tigrinya
6665 Bashkir	7089 Frisian	7583 Kashmiri	8083 Pashto, Pushto	8475 Turkmen
6669 Byelorussian	7165 Irish	7585 Kurdish	8084 Portuguese	8476 Tagalog
6671 Bulgarian	7168 Scots Gaelic	7589 Kirghiz	8185 Quechua	8479 Tonga
6672 Bihari	7176 Galician	7665 Latin	8277 Rhaeto-Romance	8482 Turkish
6678 Bengali/Bangla	7178 Guarani	7678 Lingala	8279 Romanian	8484 Tatar
6679 Tibetan	7185 Gujarati	7679 Laotian	8285 Russian	8487 Twi
6682 Breton	7265 Hausa	7684 Lithuanian	8365 Sansrit	8575 Ukrainian
6765 Catalan	7273 Hindi	7686 Latvian, Lettish	8368 Sindhi	8582 Urdu
6779 Corsican	7282 Croatian	7771 Malagasy	8372 Serbo-Croatian	8590 Uzbek
6783 Czech	7285 Hungarian	7773 Maori	8373 Singhalese	8673 Vietnamese
6789 Welsh	7289 Armenian	7775 Macedonian	8375 Slovak	8679 Volapuk
6865 Danish	7365 Interlingua	7776 Malayalam	8376 Slovenian	8779 Wolof
6869 German	7378 Indonesian	7778 Mongolian	8377 Samoan	8872 Xhosa
6890 Bhutani	7383 Icelandic	7779 Moldavian	8378 Shona	8979 Yoruba
6976 Greek	7384 Italian	7782 Marathi	8379 Somali	9072 Chinese
6978 English	7387 Hebrew	7783 Malay	8381 Albanian	9085 Zulu
6979 Esperanto	7465 Japanese	7784 Maltese	8382 Serbian	

Video Setup

- A user can set up a connected TV condition and screen.

- 1** **While STOP, press [SETUP] button.**



- 2** **Selecting TV Aspect.**
Set your preferred TV ASPECT ratio with [ENTER] button.



If a user selects "4:3 PS", the user can watch only a center of the original scene of "16:9". If a user selects "4:3 LB", the user can watch the original scene of "16:9", but the top and bottom of the screen look black color.

If a disc size is originally recorded in 4:3, a user cannot watch it in a wide screen though a user sets a size as "16:9 Wide".

- 3** **Selecting SCAN MODE.**
You may set SCAN MODE to INTERLACED or PROGRESSIVE.



* If SCAN MODE is set to "INTERLACED", connect Y/Pb/Pr on the DVD+VCR to the INTERLACED input on your TV.

If SCAN MODE is set to "PROGRESSIVE", connect Y/Pb/Pr on the DVD+VCR to the PROGRESSIVE SCAN input on your TV.

- 4** **DivX® REG.**
Please use this code to register this player with the DivX® Video On Demand service.

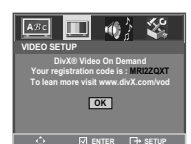

This will allow you rent and purchase video using the DivX® Video On Demand format.

To learn more go to www.divx.com/vod.
Your Registration Code is : *****.

Audio Setup

- A user may select audio menu according to a user's speaker set.

- 1** While STOP or Resume STOP, press [SETUP] button.

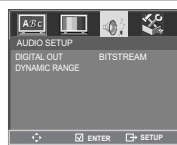

- 2** Select a Digital Output.
Set audio output to coaxial. You can set the outgoing digital signal to BITSTREAM or LPCM:



- **BITSTREAM**: The raw audio signal recorded on the disc goes to the digital audio output.
- **LPCM**: The decoded audio signal goes to the digital audio output.

- 3** Select a Dynamic Range.
Select the Dynamic Range and set the level using the [▲/▼] button. Then press the [ENTER] button.

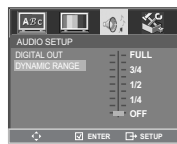

- **Off**: You can hear the sound as it was originally recorded on the disc.
- **Full**: You can hear loud sounds softer and soft sounds louder.

Others Setup

- 1** While STOP or RESUME STOP, press [SETUP] button.

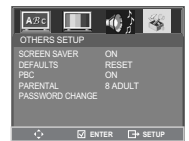

- 2** Select screensaver.
If bright scenes continue to be displayed on screen, TV can be damaged. Set the screensaver to "On", the screensaver functions automatically and DVD logo moves continuously if the resume stop, stop, open status is maintained for about 5 minutes.



- 3** Restoring DEFAULTS.
This feature resets every function to its original Factory Defaults except the Parental Control settings.



- 4** Select PBC.
You can select the PBC(Playback Control) Status.

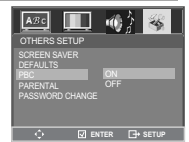

- 5** Select Parental.
Press [ENTER] button when the cursor is located in PARENTAL.

Change Parental Rating level.

Select the desired Parental level and press [ENTER].

When "PASSWORD" appears on the screen input the password and press [ENTER].

These 8 levels of parental control, protect children from watching violence, sexual scenes and other objectionable material.

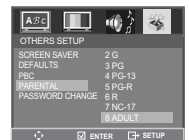

6 Changing a password.
To change your password, move the cursor to "PASSWORD CHANGE" and press [ENTER].

Then enter "OLD PASSWORD", "NEW PASSWORD" and "CONFIRM PASSWORD". Then press [ENTER].

Now your password is changed.



The initial password is 3308. In case you forget newly-input password, you can use 3308 as a password.

"Parental Lock" activates only if you set a password and the unit goes into Lock status. When the disc has no parental function even if the disc for adult only, Parental Lock doesn't activate.

About DVD

Playable Disc

- DVD, Video CD (Version 1.1, 2.0), S-VCD and Audio CD

Disc type	Playable	Restriction
DVD	Possible	Region number 2 or Region number All
Video CD	Possible	Version 1.0/1.1/2.0, SVCD
CD	Possible	PCM or dts
CD-ROM	Possible	MP3 File
CD-R	Possible	Video-CD/CD/MP3/DivX® Video/JPG
CD-RW	Possible	Video-CD/CD/MP3/DivX® Video/JPG
DVD±R	Possible	DVD Video/MP3/DivX® Video/JPG
DVD±RW	Possible	DVD Video/MP3/DivX® Video/JPG
DivX® Video	Possible	.avi/ .DivX/ .mpeg/ .mpg File
DVD-ROM	Impossible	
DVD-RAM	Impossible	
Photo CD	Possible	except KODAC CD

- You should record the file with standard format.
- Playback of some discs such as CD-R, CD-RW, DVD-R, DVD-RW, or DVD+RW may be impossible according to its record status.

REGION MANAGEMENT INFORMATION

This unit is designed and manufactured to respond to the Region Management information that is recorded on a DVD disc. The region number of this player is "2". If the region number described on the DVD discs does not correspond to the Region number of this player, the player will not play this disc. This player will play DVD discs made for "ALL" regions. Therefore, this player will play DVD discs marked with labels containing the region number "2" or "ALL".



(Region 2)



(Region ALL)

Terms related with DVD

- DVD** A DVD (abbreviation of Digital Versatile Disc or Digital Video Disc) can include 135 minutes of video information. And for audio, it can hold up to 8 kinds of languages and 32 kinds of subtitle languages. By using MPEG-2 video compression and digital 3D surround sound, DVD realizes high-defined screen and quality sound like a movie theater.
- CDDA** A CDDA (abbreviation of Compact disc digital audio) is a music disc that is currently used.
- MP3** Audio compression format that enables audio files to be stored and transferred on a computer with a relatively small file size. It enables you to enjoy CD quality music. (Short for MPEG-1 Layer 3)

About DVD

PBC	This is recorded on a Video CD 2.0, Video CD 3.0 and SVCD. The scenes or information to be viewed (or listened to) can be selected interactively with the TV monitor by looking at the menu shown on the TV monitor. It stands for PlayBack Control.
CHAPTER	It means the information recorded in a DVD. A title in a DVD is divided into many tracks, of which a track is called as a chapter. A certain scene of a screen can be quickly searched with the chapter number.
TITLE	It means the information recorded in a DVD. A DVD can be divided into many titles.
TRACK	It means the information recorded in a video CD and audio CD. A disc consists of many a track, for which a user can search a certain position.
dts	Digital Theatre System is a 5.1 -channel surround sound system, which is widely used in movie theatres around the world. It enables the bit rate to be increased to provide good sound quality. "DTS" and "DTS Digital Out" are trademarks of Digital Theater Systems, Inc.
Multi Angle	Some DVD discs contain the various scenes that have been simultaneously shot from a number of different angles.
PCM	Linear PCM is a signal-recording format used in a CD, while CD is recorded in 44.1kHz/16bit, a DVD is recorded in 48kHz/16bit up to 96kHz/24bit.
Dolby Digital	Dolby Digital enables the delivery of mono through 5.1-channel audio at data rates from 32 kbps to 640 kbps, thus offering flexibility and economical performance as well as uncompromised sound quality.
Bitstream	Digital audio data that is decoded into an analog signal for subsequent output to speakers.
L/Rt	It indicates L/R of Dolby Digital 2CH Downmix output.
Downmix	DOWNMIX is reproducing the proper audio when audio format recorded on a disc differs from the output audio channel configuration. For example, with just one stereo speaker system you can hear full 5.1 channel audio.

Handling Disc

- To keep a disc clean condition, please do not touch a side containing play information.
- Do not attach a bit of paper or sticky tape on it.
- Do not expose a disc to a direct sunlight or electric heating systems.
- After using it, please keep a disc in a case.



Cleaning Disc

- Before using it, please rub it from center toward outside with clean clothes.
- Do not use any type of solvent such as thinner, benzol (benzene), commercial cleaning goods or antistatic sprays.



Basic information about VCR and Videotape

Terms related with VCR

AFT	Automatic fine tuning, a circuit that automatically adjusts TV reception to optimum condition.
CABLE	Cable television.
Index Search	A feature of this VCR that automatically records an index each time recording begins. It helps you locate a particular segment of the tape quickly and easily.
LP	Long Play, an intermediate tape recording speed that combines most of the picture/audio quality obtainable at the standard recording speed with some of the tape economy of Extended Play (EP).
OSD	On-screen display of information pertinent to the features of the VCR.
OTR	One-touch recording, a feature that allows you to record the program you're watching by pressing the REC key. Each press of the key increases the recording time by 30 minutes, up to 10 hours.
RF	Radio frequency, the composite audio/video signal supplied to a TV receiver (or other video component) by an antenna or cable system.
Safety tab	The plastic tab at the back of a video tape cassette which, when removed, prevents accidental erasure of a recording.
SP	Standard play, the recording speed to use when the best picture quality is of prime importance (and when total recording time is not).

What is dew condensation symptom?

- If a VCR is moved from a cool place to a warm and damp place or a place facing a direct cool wind from air-conditioner...and others, temperature varies sharply, which makes dew on head drums of VCR.

If dew condensation occurs,

- First, turn it on for one or two hours before using it.
- Do not use it because it may develop troubles of a VCR or videotape.

How to use a head cleaner

- In case of a old or contaminated videotape, screen may not be clean from the contamination of VCR heads. Please remove contaminants using a head-cleaner like below order.
- Insert a head-cleaner into VCR
 - Press "PLAY" for 5 seconds, and then press "FF" for about 10 seconds.

PLAY (5secs)



FF (10secs)

- Eject a head-cleaner from VCR
 - If the screen is not clean yet, please repeat the above 2 or 3 times more.
 - A head-cleaner is not for sale. Please ask it for the nearest agent.
 - In case a user ask the removal of contaminants of us, the user should pay extra charges.

Trouble Shooting (VCR)

Symptom	Checks
<ul style="list-style-type: none"> • "Power On" does not work. • It does not work even in "Power On". 	<ul style="list-style-type: none"> ➤ Please check whether a power plug is inserted in an electric outlet. ➤ Please check whether a videotape is inserted in. ➤ Try to insert a plug again.
<ul style="list-style-type: none"> • A videotape is not inputted in. 	<ul style="list-style-type: none"> ➤ Please check whether a power plug is inserted in an electric outlet. ➤ Please check whether a videotape is in. ➤ Please check whether a videotape is inserted in a right direction (a side of transparent window should be on the upside) ➤ Have you inputted a videotape again just after the tape was ejected? Please try it again after fully ejecting it. ➤ When a videotape forces to be ejected, the tape may not be inputted. In the case, please pull out an outlet, and then push the tape smoothly.
<ul style="list-style-type: none"> • On inputting a videotape, the tape is re-ejected. 	<ul style="list-style-type: none"> ➤ That's why a safe mode to protect a videotape is operated automatically. Please pull out the tape and input it again.
<ul style="list-style-type: none"> • A videotape is not ejected. 	<ul style="list-style-type: none"> ➤ In case the product is used for a long time, a videotape may not be ejected for a film inside may be stretched. In the case, please pull out a power plug for about 10mins and then press "EJECT" button.
<ul style="list-style-type: none"> • A channel on video and a play screen does not appear. 	<ul style="list-style-type: none"> ➤ Please check your antenna's connection. ➤ TV channel should be fixed on video channel. ➤ Please check your antenna's signal whether it may be weak. In case of its weakness, please use a frequency amplifier connected with the device. ➤ Press "TV/VCR" and then let "VCR" is displayed on the display panel.
<ul style="list-style-type: none"> • Noise (screen noise) appears on screen. 	<ul style="list-style-type: none"> ➤ While in no use of VCR, was it turned on? ➤ While in recording a program, do you watch another channel? ➤ Select TV by pressing [TV/VCR] button on remote control.
<ul style="list-style-type: none"> • Noise appears on screen after recording. 	<ul style="list-style-type: none"> ➤ While in playing a videotape, there may happen some noise or blot in the part of the beginning of a videotape or resuming "PAUSE", which are not breakdown.
<ul style="list-style-type: none"> • While in playing, noise appears. 	<ul style="list-style-type: none"> ➤ Please press "TRACKING" for better screen. Videotape may be poor. Try to change it to another one.
<ul style="list-style-type: none"> • Sound and screen are irregular. • Sound comes out but screen does not appear. • Screen is irregular and stripes appears. • "Screen Error" message is displayed in a screen. 	<ul style="list-style-type: none"> ➤ Please use a head-cleaner to clean VCR heads. VCR heads may be contaminated.
<ul style="list-style-type: none"> • While recording and playing, the top of screen extremely waves. 	<ul style="list-style-type: none"> ➤ Since VCR Play signals are not stable like a TV signals, screen may be unstable or curved while in playing. To fix the problem, please horizontal adjustment.
<ul style="list-style-type: none"> • A screen is not clear. 	<ul style="list-style-type: none"> ➤ In case videotape is the one recorded by other products or old one, stripe may appear on the screen. ➤ Try to adjust the screen by [TRACKING+/-] button ➤ Try to use a head-cleaner.
<ul style="list-style-type: none"> • A screen at pause is trembling or slow screen is not clear. 	<ul style="list-style-type: none"> ➤ Try to use a head-cleaner. ➤ Try to adjust the screen by [TRACKING+/-] button.

Trouble Shooting (VCR)

Symptom	Checks
<ul style="list-style-type: none"> • Recording a TV program is impossible. 	<ul style="list-style-type: none"> ➤ For recording, you should use videotape with a tab. ➤ Please check whether a channel is fixed on video. If not, you have to turn it into "TV" by pressing "INPUT" button. ➤ Please check whether the timer recording info is right. ➤ Are RF cables inputted antenna connection terminal correctly? ➤ Does a CH number selected in display section appear? ➤ Please check a tab on a tape whether it is broken or not. (If it was broken, please scotch-tape it) ➤ Check whether a tape attached with a recording tap is inserted. ➤ Check whether the screen is displayed in VCR Only Channel. Press [INPUT] button in this remote controller to adjust in "General Broadcast" condition. ➤ Is the rounded line (RF cable) connected in "ANT.IN" terminal? ➤ Is the selected channel number shown in Display? ➤ Is a tab of cassette tape broken? (Please cover a tab hole with cellophane adhesive tape (Scotch tape).)
<ul style="list-style-type: none"> • Once pressing "REC", a videotape is ejected automatically. 	<ul style="list-style-type: none"> ➤ Please check whether the clock is right. ➤ Does the display on your video show "[]" (Ready to timer recording)? Please make it out. ➤ Please check whether the timer recording info is right. ➤ Please check a tab on a tape whether it is broke or not. (If it was broken, please scotch-tape it)
<ul style="list-style-type: none"> • Timer recording of Cable TV does not work. 	<ul style="list-style-type: none"> ➤ Was a cable data output code connected correctly? ➤ Were a converter manufacturer setup and output channel right? ➤ Did you enter a password? (Please cancel it.) ➤ Did you turn off your player? (Please turn it on.)
<ul style="list-style-type: none"> • In spite of pressing "CHANNEL", a channel can not be set. 	<ul style="list-style-type: none"> ➤ You may not memorize channels. ➤ Please check your channel setting or press a number button.
<ul style="list-style-type: none"> • While duplicating, screen is not clean and distorted. 	<ul style="list-style-type: none"> ➤ Some tapes or discs distributed in the market for lending is set to prevent copy in manufacturing. These tapes cannot be duplicated in a good condition.
<ul style="list-style-type: none"> • remote control does not work. 	<ul style="list-style-type: none"> ➤ Battery may be weak or exhausted. ➤ A receiver of remote control may be different with a sender.
<ul style="list-style-type: none"> • Buttons on remote control do not work. 	<ul style="list-style-type: none"> ➤ In case a videotape is positioned in the beginning, "VISS REW" and "REW" do not work. ➤ In case a videotape is positioned in the end, "FF", "VISS FF", "PLAY" and "REC" do not work. ➤ Please check whether another button is pressed.
<ul style="list-style-type: none"> • VISS index search does not work. 	<ul style="list-style-type: none"> ➤ Are you playing a tape that is not recorded in this recorder? (Try to record it with the recorder.) ➤ You may start recording it in "REC-PAUSE". Please start recording it from stop condition.
<ul style="list-style-type: none"> • Cable broadcasting can not be selected. 	<ul style="list-style-type: none"> ➤ Please select "CABLE" not "NETWORK" from the "CHANNEL SETTING".

Trouble Shooting (DVD)

Symptom	Checks
• The recorder does not play.	<ul style="list-style-type: none"> ➤ If a DVD is from overseas, it may not be played. Please check a DVD's region code whether it has the relative region code 2 or All. ➤ Please check whether a DVD is inserted in a right direction. ➤ If it is a CD-ROM for PC or DVD-ROM, it does not work.
• No sound comes through.	<ul style="list-style-type: none"> ➤ Play mode may be "SLOW" or "PAUSE"(In abnormal speed play, no sound comes through) ➤ Did you connect the parts in right way? ➤ Please check the operative condition of TV or amplifier. ➤ From SETUP, please check "AUDIO" items.
• Blue Screen, No functions	<ul style="list-style-type: none"> ➤ Progressive or interlace selected incorrectly. ➤ Press [SYSTEM] button (Refer page 54)
• A disc is playing but screen does not appear or poor screen appears.	<ul style="list-style-type: none"> ➤ Did you turn on your TV sets? ➤ Did you connect the parts in right way? ➤ The play may be in "PAUSE". ➤ A disc may have some contaminants or be damaged. ➤ A disc may be bad one.
• Sound is irregular	<ul style="list-style-type: none"> ➤ Please check the connection with Dolby Digital amplifier. ➤ Please check the plugs are connected with one another tightly. ➤ Some contaminants may be remained in connection terminal.
• REMOTE does not work.	<ul style="list-style-type: none"> ➤ Please check the degree of remote control, distance or any interruption. ➤ Battery may be weak or exhausted. ➤ When you operate DVD, use it by pressing [DVD] button.
• Dolby Digital sound does not work	<ul style="list-style-type: none"> ➤ Dolby Digital sound can be worked in the Dolby Digital amplifier only. ➤ Please check "Dolby Digital" mark on your DVD. ➤ In case of playing it through digital output, while pressing "STOP", please check whether "Digital Output" is "Bitstream" by pressing "SETUP". ➤ Please check the connection is correct.
• "AUDIO" or "SUBTITLE" button does not work.	<ul style="list-style-type: none"> ➤ If a DVD does not include language information, it does not support the function.
• "ANGLE" button does not work while a DVD is playing.	<ul style="list-style-type: none"> ➤ "ANGLE" is supported only in a DVD contains multi angle scenes. Also a user can confirm the support with the "ANGLE" mark on screen.
• "MENU" does not appear while a DVD is playing.	<ul style="list-style-type: none"> ➤ Please check the degree of remote control, distance or any interruption. ➤ Please check a battery in remote control whether it is exhausted or not. ➤ A DVD may not contain menu information.
• The file name of MP3 (CD-R) appears with strange letters.	<ul style="list-style-type: none"> ➤ The file name of MP3 recognize only the Alphabet (A-Z, a-z), numbers (0-9) and a special symbol on keyboard (-, !, @, #, \$...) and 10 letters can be displayed in maximum. ➤ The letters except above case will be displayed like "----".
• Any MP3 (CD-R) file isn't displayed.	<ul style="list-style-type: none"> ➤ If the surface of disk is injured, the file display and playback can be impossible.

Specifications

Power	200~240V, 50/60Hz
Consumed electricity	20W
Weight	4.6kg
Dimension (W x H x D)	435mmx93mmx255mm(Without Foot), 435mmx98mmx255mm(With Foot)
Operative temperature	+5°C~40°C
Installation condition	Horizontal / Relative humidity under 80%
Laser output	5mW (continuous wave max.)
Wave length	635nm (DVD), 730nm (CD)
Signal type	PAL COLOR
Antenna Input/output	U / V-mixed: 75Ω unbalanced
VIDEO input	1.0Vp-p (unbalanced, RCA JACK)
AUDIO input	-8.8dBm, RCA JACK
VIDEO output (common use of DVD and VCR)	VIDEO output terminal, 1.0 Vp-p unbalanced, RCA JACK
VIDEO output (DVD only)	Component output (75Ω In load Y: 1.0Vp-p, Pb:0.7Vp-p, Pr:0.7Vp-p)
AUDIO output (common use of DVD and VCR)	Audio output terminal (2 kinds): -5.8dBm(VCR), 2Vrms(DVD), RCA JACK
AUDIO output (DVD only)	Analogue AUDIO output : 2.0Vrms Digital audio output (COAXIAL)
Playable tape	Very high dense tapes with VHS marks
Playable disc	DVD, VIDEO-CD, CD (12cm), CD (8cm), MP3, CD-R, CD-RW
Tape speed	SP: 23.39mm/s, LP: 11.70mm/s
Playtime	SP: 3hrs, LP: 6hrs (use of E180tape)
Clock display	24 hrs
Time Recording	8 programs a month
Persistence in power failure	1min
VIDEO S/N (VCR)	Over 43dB(Standard recording)
Resolution	VCR Over 240 lines (Standard recording)
	DVD Over 400 lines (Playback DVD)
AUDIO (VCR)	Over 65dB
AUDIO (DVD)	90dB
AUDIO dynamic range	90dB

DVD Audio output standards

Output	Disc type		
	DVD	VIDEO-CD	CD
Analogue Audio output	48/96KHz sampling	44.1KHz sampling	44.1KHz sampling
Digital Audio output	48KHz sampling	44.1KHz sampling	44.1KHz sampling

QUICK START GUIDE FOR SORTING CHANNELS ON THE DVD COMBO

Once the 'Auto Set' function has been completed the On Screen Display will show a list of the channels which it has found, displayed in the order it found them.

It is unlikely, that they will be in the correct order ie. ARD as PR01, ZDF as PR02, P-03 as PR03, p-04 as PR04 and MTV as PR05.

Therefore, it will be necessary to Sort the channels displayed, into the correct order.

Please follow the following procedure.

- 1 Press the [VCR] button to select the VCR mode.
- 2 Press the [SETUP] button.
- 3 Select the 'PR PRESET' using [▲/▼] buttons and press the [OK/ENTER] button.
- 4 Select the 'PR ALIGN' using [▲/▼] buttons and press the [OK/ENTER] button.
- 5 Select the channel that needs to be moved and press the [OK/ENTER] button.
- 6 Press the [OK/ENTER] button in order to select the 'PR' number which you want to place the current selected channel using [▲/▼] buttons. ie. PR01 ARD. And press the [OK/ENTER] button to confirm.

Repeat above 5-6 steps to align the other channels.

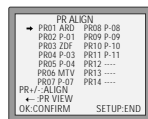
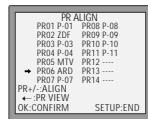
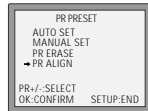
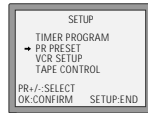
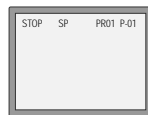

DAEWOO
ELECTRONICS



INSTRUCTION MANUAL

DVD PLAYER+VIDEO CASSETTE RECORDER

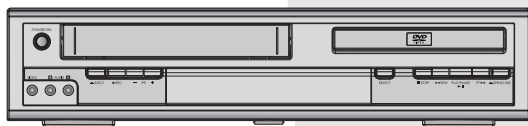

SF-7200D

ENGLISH

Please read this manual carefully before connecting your DVD+VCR and operating it for the first time.

Keep the manual in a safe place for future reference.

P/N: 97P956000-AN