

YAMAHA®

AUTHORIZED
PRODUCT MANUAL

YPP-50

Personal Electronic Piano

YAMAHA

Personal Electronic Piano

YPP-50

Owner's Manual

IMPORTANT

Check your power supply

Make sure that your local AC mains voltage matches the voltage specified on the name plate on the bottom panel. In some areas a voltage selector may be provided on the rear panel of the main keyboard unit. Make sure that the voltage selector is set for the voltage in your area.

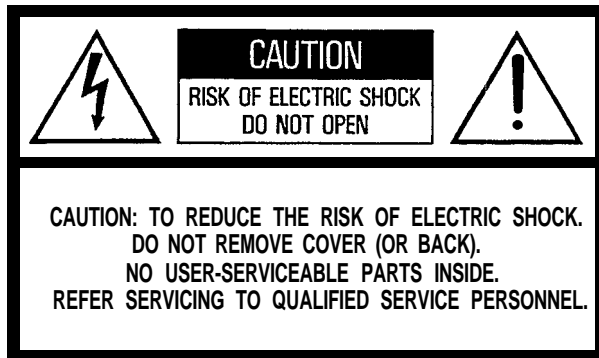

See bottom of keyboard enclosure for graphic symbol markings

The lightning flash with arrowhead symbol, within an equilateral triangle, is intended to alert the user to the presence of uninsulated “dangerous voltage” within the product’s enclosure that may be of sufficient magnitude to constitute a risk of electric shock to persons.



The exclamation point within an equilateral triangle is intended to alert the user to the presence of important operating and maintenance (servicing) instructions in the literature accompanying the product.



IMPORTANT SAFETY AND INSTALLATION INSTRUCTIONS

INFORMATION RELATING TO POSSIBLE PERSONAL INJURY, ELECTRIC SHOCK, AND FIRE HAZARD POSSIBILITIES HAS BEEN INCLUDED IN THIS LIST.

WARNING —When using electronic products, basic precautions should always be followed, including the following:

1. Read all Safety and Installation Instructions, Explanation of Graphical Symbols, and assembly instructions (where applicable) BEFORE using your Yamaha electronic product. Check unit weight specifications before you attempt to move this instrument!
2. Main Power Supply Verification: Your Yamaha electronic product has been manufactured specifically for the main supply voltage used in your area. If you should move, or if any doubt exists, please contact your dealer for instructions. The main supply voltage required by your electronic product is printed on the name plate. For name plate location, see “TAKING CARE OF YOUR PERSONAL ELECTRONIC PIANO” item.
3. This product may be equipped with a polarized line plug (one blade wider than the other). If you are unable to insert the plug into the outlet, contact an electrician to have your obsolete outlet replaced. Do NOT defeat the safety purpose of the plug. Yamaha products not having polarized plugs incorporate construction methods and designs that do not require line plug polarization.
4. **WARNING**—Do NOT place objects on your electronic product’s power cord or place the unit in a position where anyone could trip over, walk over, or roll anything over cords of any kind. Do NOT allow your electronic product or its bench to rest on or be installed over cords of any type. Improper installations of this type create the possibility of a fire hazard and/or personal injury.
5. Environment: Your electronic product should be installed away from heat sources such as a radiator, heat registers and/or other products that produce heat. Additionally, the unit should not be located in a position that exposes the cabinet to direct sunlight, or air currents having high humidity or heat levels.
6. Your Yamaha electronic product should be placed so that its location or position does not interfere with its proper ventilation.
7. Some Yamaha electronic products may have benches that are either a part of the product or supplied as an optional accessory. Some of these benches are designed to be dealer assembled. Please make sure that the bench is stable before using it. The bench supplied by Yamaha was designed for seating only. No other uses are recommended.
8. Some Yamaha electronic products can be made to operate with or without the side panels or other components that constitute a stand. These products should be used only with the components supplied or a cart or stand that is recommended by the manufacturer.
9. Do not operate for a long period of time at a high volume level or at a level that is uncomfortable. If you experience any hearing loss or ringing in the ears, you should consult an audiologist.
10. Do not use your Yamaha electronic product near water or in wet environments. For example, near a swimming pool, spa, or in a wet basement.
11. Care should be taken so that objects do not fall, and liquids are not spilled, into the enclosure through openings.
12. Your Yamaha electronic product should be serviced by a qualified service person when:
 - a. The power-supply cord or plug has been damaged: or
 - b. Objects have fallen, or liquid has been spilled into the product: or
 - c. The product has been exposed to rain: or
 - d. The product does not operate, exhibits a marked change in performance: or
 - e. The product has been dropped, or the enclosure of the product has been damaged.
13. When not in use, always turn your Yamaha electronic product “OFF”. The power-supply cord of the product should be unplugged from the outlet when it is to be left unused for a long period of time. Notes: In this case, some units may lose some user programmed data. Factory programmed memories will not be affected.
14. Do not attempt to service the product beyond that described in the user-maintenance instructions. All other servicing should be referred to qualified service personnel.
15. Electromagnetic Interference (RFI). This series of Yamaha electronic products utilizes digital (high frequency pulse) technology that may adversely affect Radio/TV reception or the operation of other devices that utilize digital technology. Please read FCC Information (Page 40) for additional information.

**PLEASE KEEP THIS MANUAL
FOR FUTURE REFERENCE!**

Introduction

Thank you for choosing a Yamaha YPP-50 Personal Electronic Piano. Your Personal Electronic Piano is a fine musical instrument that employs advanced Yamaha music technology. With the proper care, it will give you many years of musical pleasure.

- Yamaha's sophisticated AWM (Advanced Wave Memory) tone generator system offers rich, realistic reproductions of digitally sampled keyboard sounds.
- 8-note polyphony permits use of most standard playing techniques.
- Piano-like touch response provides extensive expressive control and outstanding playability.
- Performance Memory function records and plays back your keyboard performances-and you can play along on the keyboard as the recorded performance plays back!
- Built-in metronome facilitates practice and helps to develop an accurate sense of timing.
- MIDI compatibility and a range of MIDI functions make the Personal Electronic Piano useful in a range of advanced MIDI music systems.

In order to make the most of your Personal Electronic Piano's performance potential and features, we urge you to read this Owner's Manual thoroughly, and keep it in a safe place for later reference.

Contents

KEYBOARD STAND		MIDI Transmit & Receive	
ASSEMBLY.....	2	Channel Selection.....	10
TAKING CARE OF YOUR		Local Control ON/OFF.....	11
PERSONAL ELECTRONIC		Program Change ON/OFF.....	11
PIANO	6	Control Change ON/OFF.....	11
THE CONTROLS AND		The Multi-Timbre Mode.....	12
CONNECTORS: BASIC		The Split & Left Local OFF	
OPERATION	6	Mode	12
ENJOY THE DEMONSTRATION	8	The Split & Right Local OFF	
PLAYING THE PERSONAL		Mode	12
ELECTRONIC Piano.....	8	Transmitting the Panel	
TRANSPOSITION	8	Settings	12
PITCH CONTROL.....	9	TRUBLESHOOTING	13
THE PERFORMANCE MEMORY	9	OPTIONS & EXPANDER	
MIDI Functions.....	10	MODULES	13
A Brief Introduction to MIDI....	10	MIDI DATA FORMAT.....	13
MIDI "Messages" Transmitted		SPECIFICATIONS.....	14
& Received by the Personal			
Electronic Piano.....	10		

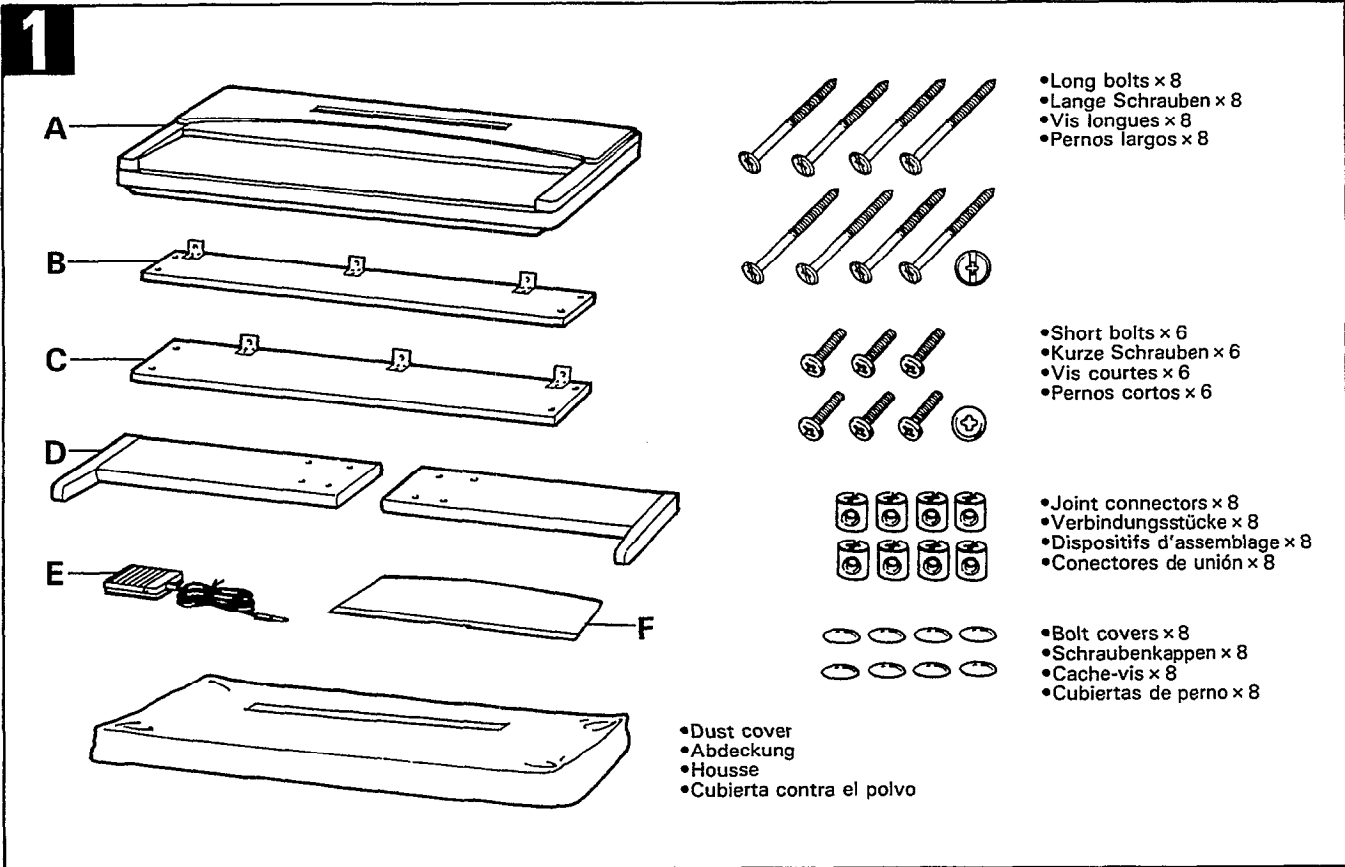

KEYBOARD STAND ASSEMBLY

NOTE: Although the YPP-50 keyboard stand can be assembled by a single person, the job is much easier with two people.

1 Open the box and remove all the parts.

On opening the box you should find the parts shown in the illustration. Check to make sure that all the required parts, are provided.

2 Invert the main unit (A).

When main unit (A) is removed from the box, place it upside-down on a soft, non-abrasive surface such as a clean rug or blanket to prevent scratches to the finish. This inverted position makes it easier to attach the assembled keyboard stand later on.

3 Attach the side panels (D) to the front (B) and rear (C) panels.

Begin by installing the joint connectors in the front (B) and rear (C) panels as shown in the illustration. The front and rear panels (the rear panel is the wider one) are attached between the side panels (D) using two long bolts at each end. The sides of the side panels (D) with the recesses at the top face inwards; the direction in which the feet extend from the side panels is the "front" (the direction the keyboard faces). The metal brackets on the front (B) and rear (C) panels face upwards and inwards. Attach the first panel loosely so that the second panel slides into position easily, then attach the second panel and finally tighten all eight bolts. When the assembly is complete and the bolts are securely tightened, snap the eight plastic bolt covers into place over the bolt heads.

- When installing the joint connectors in the holes in the panels, make sure that the arrows printed on their upper surface face in the direction shown in the illustration.

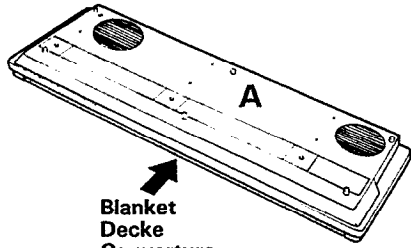
2

Blanket
Decke
Couverture
Manta

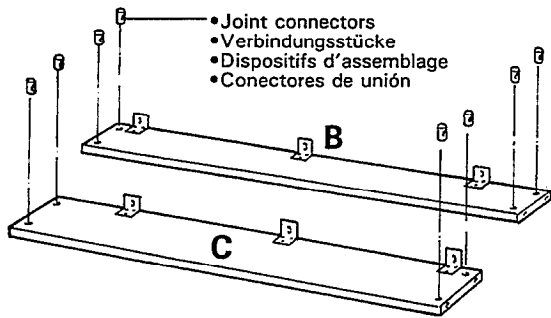
3

- Joint connectors
- Verbindungsstücke
- Dispositifs d'assemblage
- Conectores de unión

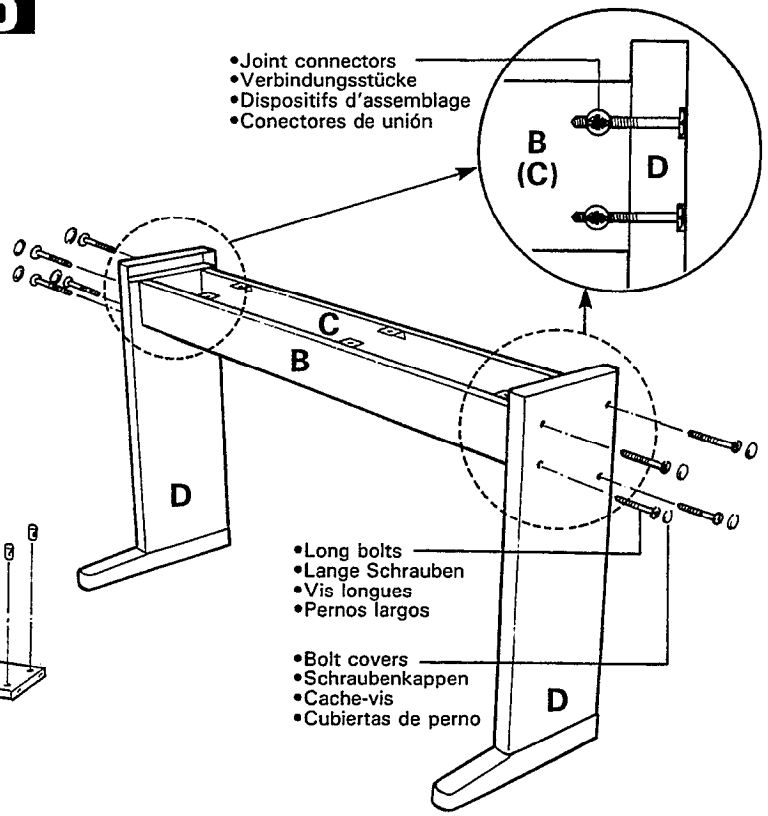

- Joint connectors
- Verbindungsstücke
- Dispositifs d'assemblage
- Conectores de unión

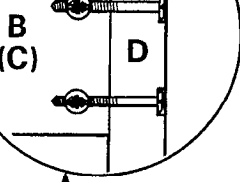

- Long bolts
- Lange Schrauben
- Vis longues
- Pernos largos

- Bolt covers
- Schraubekappen
- Cache-vis
- Cubiertas de perno

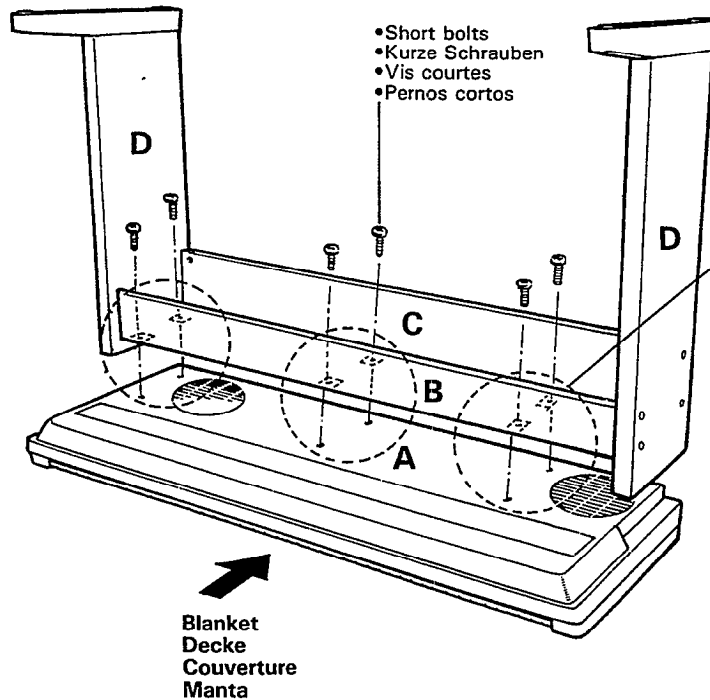
4

- If the holes in the metal brackets on the front (B) and rear (C) panels do not line up properly with the screw holes in the main unit (A), loosen the long bolts connecting the side panels (D) to the front and rear panels, align the holes, screw in the short bolts firmly, then re-tighten the side-panel long bolts.
- Falls die Löcher in den Metallhalterungen der vorderen (B) und hinteren (C) Verbindungsstrebe nicht mit den Schraubenlöchern im Keyboard (A) fluchten, die langen Schrauben, die die Standbeine (D) an den Verbindungsstreben halten, etwas lösen und die Löcher fluchten. Dann die kurzen Schrauben fest hineindrehen und anschließend die langen Schrauben wieder festziehen.
- Si les orifices des ferrures de montage du panneau avant (B) et du panneau arrière (C) ne sont pas alignés correctement sur les orifices de vis du piano (A), desserrer les vis longues fixant les panneaux latéraux (D) aux panneaux avant et arrière, aligner les orifices, serrer à fond les vis courtes et resserrer les vis longues des panneaux latéraux.
- Si los orificios de las ménsula metálicas de los paneles frontal (B) y posterior (C) no se alinean correctamente con los orificios para los tornillos de la unidad principal (A), afloje los pernos largos que conectan los paneles laterales (D) a los paneles frontal y posterior, alinee los orificios, enrosque bien los pernos cortos y vuelva a apretar los pernos largos de los paneles laterales.

4**Attach the stand assembly to the main unit (A).**

Turn the assembled stand upside down and place it on top of the main unit (which should also be upside-down) with the feet extending toward the keyboard side of the main unit. The tops of the side panels fit into the recessed areas at the ends of the main unit. Align the holes in the front and rear panel brackets with the holes in the bottom of the main unit, and firmly screw in the six short bolts through the brackets. Finally, turn the entire assembly rightside-up and stand it on its feet.

* *Check to make sure that all screws have been securely tightened.*

5**Plug in the damper pedal (E)**

Plug the supplied FC5 damper pedal cable into the DAMPER jack on the rear panel of the main unit, and place the pedal in a convenient position on the floor below the keyboard.

6**Install the music stand (F)**

Insert the bottom (flat) edge of the music stand (F) into the slot on the top of the main unit (A) so that the music stand leans backwards away from the keyboard.

5

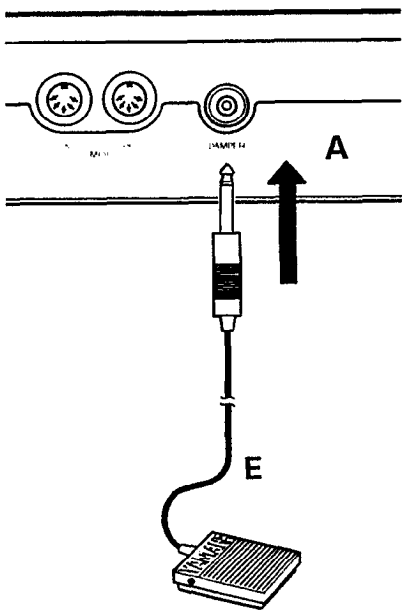

6

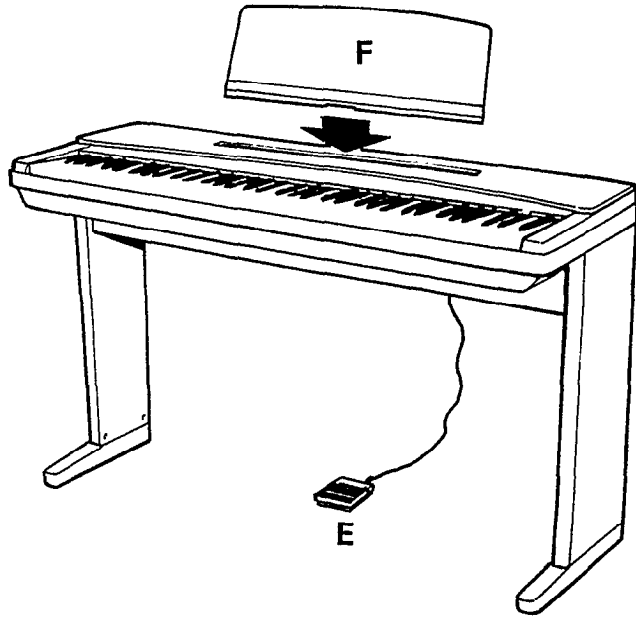

TAKING CARE OF YOUR PERSONAL ELECTRONIC PIANO

Your Personal Electronic Piano is a fine musical instrument, and deserves the most careful treatment. Observe the following points and your Personal Electronic Piano will sound and look great for many years.

1. Never open the case and touch or tamper with the internal circuitry.
2. Always turn the POWER switch OFF after use, and cover the keyboard with the supplied cover.
3. Clean the cabinet and keys of your Personal Electronic Piano only with a clean, slightly damp cloth. A neutral cleanser may be used if desired. Never use abrasive cleansers, waxes, solvents or chemical dust cloths since these can dull or damage the finish.
4. Never place any vinyl products on your Personal Electronic Piano. Contact with vinyl can cause irreversible damage to the finish.
5. Install your Personal Electronic Piano in a place that is away from direct sunlight, excessive humidity or heat.
6. Never apply excessive force to the controls, connectors or other parts of your Personal Electronic Piano, and avoid scratching or bumping it with hard objects.
7. Do not leave heavy objects on the keyboard for an extended length of time.
8. Never spill water, beverages or other liquids on the keyboard or any other part of the Personal Electronic Piano.
9. The YPP-50 contains digital circuitry and may cause interference if placed too close to radio receivers, television sets or similar radio-frequency reception equipment. If such a problem occurs, move the YPP-50 further away from the affected equipment.
10. **IMPORTANT!:** Check your power supply!
Make sure that your local AC mains voltage matches the voltage specified on the name plate on the bottom panel. In some areas a voltage selector may be provided on the rear panel of the main unit. Make sure that the voltage selector is set for the voltage in your area.
 - **Name Plate Location**
The YPP-50 nameplate is located on the bottom panel.

THE CONTROLS AND CONNECTORS: BASIC OPERATION

① POWER Switch

Press the POWER switch once to turn the power ON, a second time to turn the power OFF. When the power is initially turned ON, the PIANO voice selector LED will light.

② MASTER VOLUME Control

The MASTER VOLUME control adjusts the volume (level) of sound produced by the Personal Electronic Piano. The MASTER VOLUME control also adjusts headphone volume when a pair of headphones is plugged into the HEADPHONE jack ⑨.

③ MIDI/TRANPOSE Button

The MIDI/TRANPOSE button allows access to the Personal Electronic Piano's TRANPOSE function (to shift the pitch of the entire keyboard up or down) and MIDI functions. For details refer to the "TRANSPPOSITION" and "MIDI FUNCTIONS" sections on pages 8 and 10, respectively.

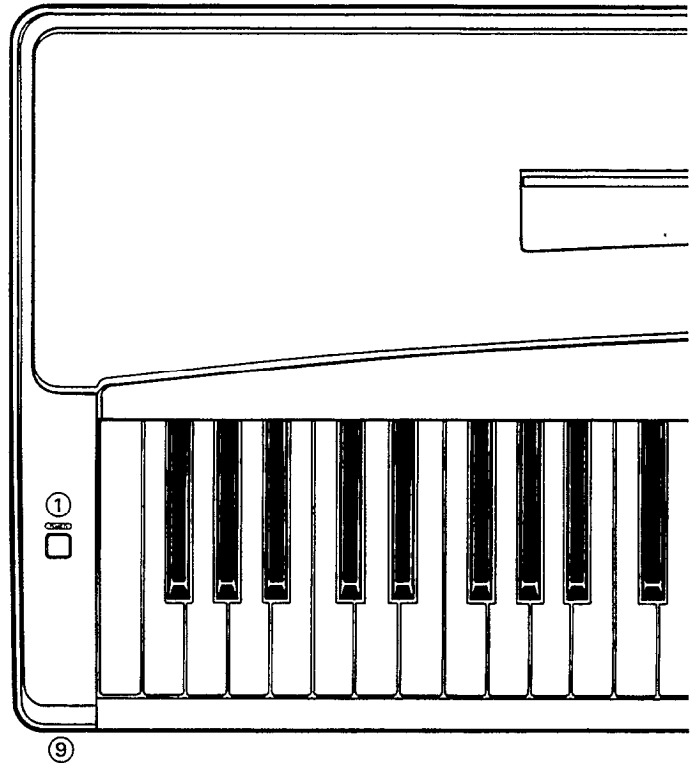

④ METRONOME Button

Press the METRONOME button to start the YPP-50's built-in metronome. The metronome will sound at either the initial tempo of 120 beats per minute, or a tempo set using the TEMPO ▲ and ▼ buttons, described below. The METRONOME button LED will flash on the first beat of each measure. Press the METRONOME button a second time to stop the metronome sound.

- **Metronome Volume:** The volume of the metronome sound can be independently adjusted in five steps (normal volume plus two steps up and two down) by pressing the TEMPO ▲ or ▼ button while holding down the METRONOME button. The ▲ button increases the volume while the ▼ button decreases the volume. Normal volume can be restored by holding the METRONOME button and pressing both the TEMPO ▲ and ▼ buttons simultaneously.

Note: The metronome is also related to operation of the YPP-50 Performance Memory. This relationship will be described in the "PERFORMANCE MEMORY" section on page 9.

TEMPO ▲ and ▼ Buttons

The TEMPO ▲ and ▼ buttons are mainly used to adjust the tempo of the YPP-50 metronome. The tempo can be adjusted from 32 to 280 beats per minute in the following steps:

32	36	40	44	48	52	56	60	64	66	68
70	72	74	76	78	80	82	84	86	88	90
92	94	96	98	100	102	104	106	108	110	112
114	116	118	120	122	124	126	128	130	132	136
140	144	148	152	156	160	168	176	184	192	200
208	216	224	232	240	248	256	264	272	280	

When the power is initially switched ON, the tempo is automatically set to 120. Each brief press on the ▲ or ▼ button increases or decreases the tempo by one step, respectively. Holding the ▲ or ▼ button down causes continuous incrementing or decrementing of the tempo value. The initial tempo of 120 can be restored at any time by pressing the TEMPO ▲ and ▼ buttons simultaneously.

Note: The TEMPO ▲ and ▼ buttons are also used for transposition and metronome volume control—see ④ METRONOME Button above, and "TRANSPPOSITION" on page 8 for details.

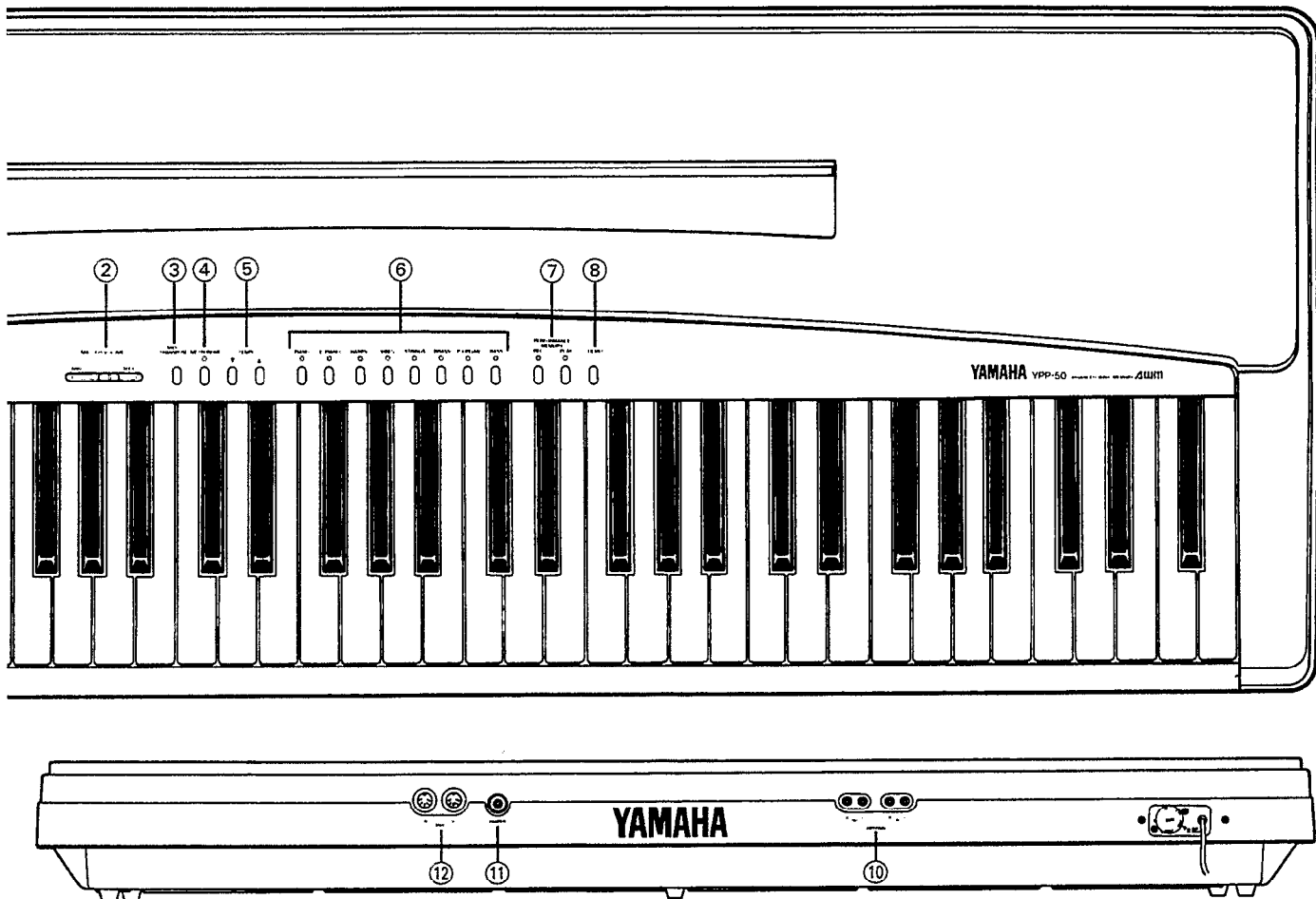

⑥ Voice Selectors

The YPP-50 has eight voice selectors. Simply press any of the voice selectors to select the corresponding voice. The LED indicator above the voice selector will light to indicate which voice is currently selected.

- **The Bass Split Mode:** The YPP-50 Bass Split Mode allows the BASS voice to be played on all keys to the left of and including the F[#]₂ key, and any other voice to be played on all keys to the right of the F[#]₂ key. To activate the Bass Split mode and select the right-hand voice, hold down the BASS voice selector and press the voice selector corresponding to the desired right-hand voice, then release both voice selectors. Both the BASS LED and the LED of the selected right-hand voice will light. Please note that the damper pedal does not affect the bass voice in the Bass Split mode. The Bass Split mode can be disengaged and the normal voice mode restored by simply pressing any single voice selector.

Note: The PIANO voice is automatically selected whenever the POWER switch is initially turned ON.

⑦ PERFORMANCE MEMORY REC and PLAY Buttons

These buttons activate the YPP-50 Performance Memory record and playback functions. Operation of the Performance Memory is described in detail on page 9.

⑧ DEMO Button

Press the DEMO button to hear the YPP-50's pre-programmed demonstration. Further details are given on page 8.

⑨ HEADPHONE Jack

A standard pair of stereo headphones can be plugged in here for private practice or late-night playing. The internal speaker system is automatically shut off when a pair of headphones is plugged into the HEADPHONE jack.

⑩ OPTIONAL IN L/R and OUT L/R Jacks

These jacks are intended primarily for use with Yamaha EM-series Expander Modules such as the EME-1 Reverb Box, EMT-1 FM Sound Box, EMT-10 AWM Sound Box and EMR-1 Drum Box. In the case of the EME-1 Reverb Box, for example, the OPTIONAL OUT jacks connect to the EME-1 LINE IN jacks, and the EME-1 LINE OUT jacks connect back to the Personal Electronic Piano OPTIONAL IN jacks. This allows application of a range of high-quality digital effects, including reverb and echo, to the Personal Electronic Piano sound. Refer to the EM-series Expander Module device owner's manual for connection details.

⑪ DAMPER Jack

The supplied damper pedal (Yamaha FC-5) should be plugged in here. The damper pedal functions in the same way as a damper pedal on an acoustic piano. When the damper pedal is pressed notes played have a long sustain. Releasing the pedal immediately stops (damps) any sustained notes.

⑫ MIDI IN and OUT Connectors

The MIDI IN connector receives MIDI data from an external MIDI device (such as the EMQ-1 Memory Box) which can be used to control the Personal Electronic Piano. The MIDI OUT connector transmits MIDI data generated by the Personal Electronic Piano (e.g. note and velocity data produced by playing the Personal Electronic Piano keyboard). More details on MIDI are given in "MIDI FUNCTIONS" on page 10.

ENJOY THE DEMONSTRATION

To give you an idea of the YPP-50's sophisticated capabilities, it is programmed with a demonstration sequence which plays automatically while demonstrating some of the instrument's voices. Short segments of the following pieces are included:

- 24 Preludes No. 15 in D flat major. "Raindrop" Op.28-15 by Chopin (PIANO voice).
- The Harmonious Blacksmith by Händel (HARPSI voice).
- Arabesque by Debussy (PIANO voice).
- Fugue in G minor by Bach (P.ORGAN voice).

1. Press the POWER switch to turn the instrument ON. The PIANO voice selector LED will light when the power is ON.



2. Slide the MASTER VOLUME control to a position about three quarters of the way towards the "MAX" setting. You can set this control for the most comfortable volume level after playback begins.

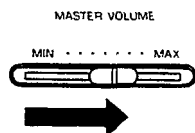

3. The demonstration music will begin playing as soon as you press the DEMO button. The demonstration will play continuously, providing samples of different voices, until the DEMO button is pressed a second time.



- A different voice or tempo can be selected at any time while the demonstration is playing (refer to the appropriate sections of this manual for instructions). Voice changes, however, will only remain in effect until the next automatic voice change.

PLAYING THE PERSONAL ELECTRONIC PIANO

After making sure that the Personal Electronic Piano's AC plug is properly inserted into a convenient AC wall outlet:

1. Press the POWER switch located to the left of the keyboard to turn the power ON. When the power is turned ON, the PIANO voice selector LED will light (the PIANO voice is automatically selected whenever the power is turned ON).



2. Initially set the MASTER VOLUME control about three quarters of the way towards the "MAX" setting. Then, when you start playing, adjust the VOLUME control for the most comfortable listening level.

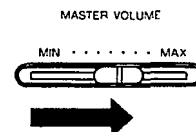

3. Select the desired voice by pressing one of the voice selectors.

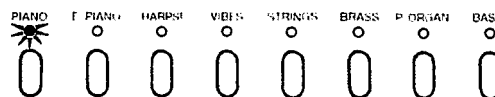

4. Play.

Note: The Personal Electronic Piano has "8-note polyphony" which means you can play up to 8 notes at once. If you activate the Bass Split mode, up to two notes can be played on the lower (bass) section of the keyboard and up to six notes can be played on the upper (right-hand) section (see "6 Voice Selectors- The Bass Split Mode" on page 7). The Metronome also uses one note, so up to seven notes can be played on the keyboard while the metronome is running (the metronome uses one note of the right-hand keyboard section when the Bass Split mode is active). The Personal Electronic Piano also offers keyboard touch response, so the volume and timbre of notes played can be controlled according to how "hard" you play the keys. The amount of variation available depends on the selected voice.

TRANSPPOSITION

The Personal Electronic Piano's TRANPOSE function makes it possible to shift the pitch of the entire keyboard up or down in semitone intervals up to a maximum of six semitones. "Transposing" the pitch of the Personal Electronic Piano keyboard makes it easier to play in difficult key signatures, and you can simply match the pitch of the keyboard to the range of a singer or other instrumentalist.

The MIDI/TRANPOSE button and TEMPO ▲ and ▼ buttons are used for transposition.

1. Press and hold the MIDI/TRANPOSE button.
2. Press the TEMPO ▲ or ▼ button as many times as necessary to produce the desired degree of transposition. Each time the TEMPO ▲ or ▼ button is pressed the pitch of the keyboard is transposed by one semitone in the specified direction (i.e. up or down). Pitch can be transposed up or down by a maximum of six semitones.*
3. Release the MIDI/TRANPOSE button.

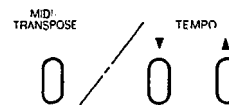

* Pressing both the TEMPO ▲ and ▼ buttons simultaneously while the MIDI/TRANPOSE button is held produces normal keyboard pitch.

PITCH CONTROL

Pitch control makes it possible to tune the Personal Electronic Piano over a ± 50 -cent range in approximately 3-cent intervals. A hundred "cents" equals one semitone, so the tuning range provided allows fine tuning of overall pitch over a range of approximately a semitone. Pitch control is useful for tuning the Personal Electronic Piano to match other instruments or recorded music.

Tuning Up

1. To tune up (raise pitch), hold the E₀ and F₀ keys simultaneously.
2. Press any key between C₃ and B₃. Each time a key in this range is pressed the pitch is increased by approximately 3 cents, up to a maximum of 50 cents above standard pitch.
3. Release the E₀ and F₀ keys.

Tuning Down

1. To tune down (lower pitch), hold the E₀ and F[#]₀ keys simultaneously.
2. Press any key between C₃ and B₃. Each time a key in this range is pressed the pitch is decreased by approximately 3 cents, up to a maximum of 50 cents below standard pitch.
3. Release the E₀ and F[#]₀ keys.

To Restore Standard Pitch*

1. To restore standard pitch (A₃ = 440 Hz), hold the E₀, F₀ and F[#]₀ keys simultaneously.
2. Press any key between C₃ and B₃.
3. Release the E₀, F₀ and F[#]₀ keys.

* Standard pitch (A₃ = 440 Hz) is automatically set whenever the POWER switch is initially turned ON.

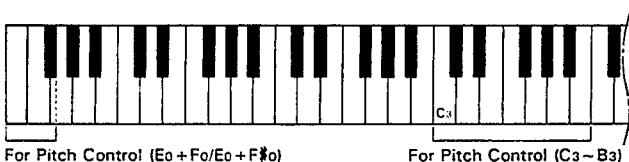

THE PERFORMANCE MEMORY

The YPP-50 Performance Memory functions as a digital recorder that allows you to record and play back anything you play on the keyboard. You can simply enjoy listening to playback of your performance, or play along with it on the keyboard. You can record using any single voice, or using the Bass Split mode for a combination of left-hand bass and right-hand chords or melody lines.

- The Performance Memory records the following data: notes played, damper pedal operations, voice selection, bass split mode, the initial tempo and tempo changes made during the recording.
- Up to approximately 1300 notes can be recorded in the Performance Memory. This number varies, however, according to damper-pedal usage and other factors.
- Material recorded using the Performance Memory will be retained in the YPP-50 memory for approximately one week even the power is left OFF the entire time. To keep the recorded performance in memory for longer periods, make sure that the YPP-50 power is turned ON briefly at least once a week.

Note: Recording can not be activated if the YPP-60 Multi-Timbre Mode is engaged (see "The Multi-Timbre Mode" in the "MIDI FUNCTIONS" section of this manual-page 101).

Recording

1. Set the Record Ready Mode

Press the PERFORMANCE MEMORY REC button. This engages the "record ready" mode: the REC LED will light and the metronome will sound at the currently selected tempo.

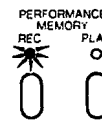

2. Set the Tempo

Before actually beginning to record, you should select a tempo that will be easy to record at (using the TEMPO ▲ and/or ▼ buttons). If you don't want to hear the metronome while recording, press the METRONOME button at this stage—the metronome sound will stop but the METRONOME LED will continue flashing at the selected tempo.

3. Start Recording

Recording will begin automatically as soon as you begin playing.

4. Stop Recording

Press the REC button a second time to stop recording. It is also possible to stop recording by pressing the PLAY button. Recording will stop automatically if you exceed the Performance Memory note capacity.

- Whenever you record using the Performance Memory, any previously recorded material will be erased.
- The Performance Memory can be erased deliberately as follows: press the PERFORMANCE MEMORY REC button while holding down the E₀ and F₀ keys (the two lowest white keys on the keyboard), release the button and keys, and then press the PERFORMANCE MEMORY REC button one more time to exit the record mode.

Playback

1. Press the PLAY Button

Playback of the Performance Memory recording begins as soon as you press the PERFORMANCE MEMORY PLAY button (the PLAY button LED will also light).

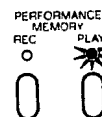

2. Play Along if You Like

Play along on the YPP-50 keyboard if you like. Please note, however, that the YPP-50's eight-note polyphony limitation still applies. In other words, the total number of notes being played back by the Performance Memory and those played on the keyboard cannot exceed eight at any instant.

3. Stop Playback

Playback will stop automatically when the end of the recording is reached. You can also stop playback at any time by pressing the PLAY or REC button. Playback will also stop if the DEMO button is pressed or if a MIDI STOP message is received via the MIDI IN connector.

MIDI FUNCTIONS

A Brief Introduction to MIDI

MIDI, the Musical Instrument Digital Interface, is a world-standard communication interface that allows MIDI-compatible musical instruments and equipment to share musical information and control one another. This makes it possible to create "systems" of MIDI instruments and equipment that offer far greater versatility and control than is available with isolated instruments. For example, most MIDI keyboards (including the Personal Electronic Piano, of course) transmit note and velocity (touch response) information via the MIDI OUT connector whenever a note is played on the keyboard. If the MIDI OUT connector is connected to the MIDI IN connector of a second keyboard (synthesizer, etc.) or a tone generator such as the Yamaha EMT-1 FM Sound Box (essentially a synthesizer with no keyboard), the second keyboard or tone generator will respond precisely to notes played on the original transmitting keyboard. The result is that you can effectively play two instruments at once, providing thick multi-instrument sounds.

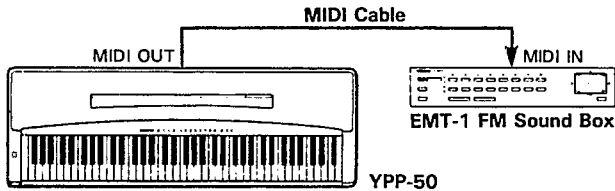

This same type of musical information transfer is used for MIDI sequence recording. A sequence recorder such as the Yamaha EMQ-1 Memory Box can be used to "record" MIDI data received from a Personal Electronic Piano, for example. When the recorded data is played back, the Personal Electronic Piano automatically "plays" the recorded performance in precise detail.

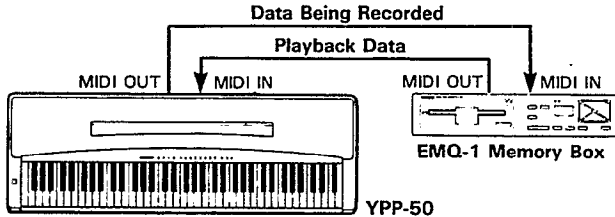

The examples given above really only scratch the surface. MIDI can do much, much more. The YPP-50 offers a number of MIDI functions that allow it to be used in fairly sophisticated MIDI systems.

Note: Always use a high-quality MIDI cable to connect MIDI OUT to MIDI IN terminals. Never use MIDI cables longer than about 15 meters, since cables longer than this can pick up noise which can cause data errors.

MIDI "Messages" Transmitted & Received by the Personal Electronic Piano

The MIDI information (messages) transmitted and received by the YPP-50 Personal Electronic Piano are as follows:

Note and Velocity Data

This information tells the receiving keyboard or tone generator to play a certain note (specified by the MIDI note number) at a certain dynamic level (specified by the MIDI velocity value). Note and velocity data is transmitted by the Personal Electronic Piano whenever a key is pressed, and the Personal Electronic Piano's internal AWM tone generator will "play" the corresponding note(s) whenever note and velocity data is received from an external MIDI device.

Program Change Numbers

The YPP-50 transmits a MIDI program number between 0 and 14 when one of its voice selectors is pressed. This normally causes the correspondingly numbered voice or program to be selected on a receiving MIDI device. The Personal Electronic Piano will respond in the same way, automatically selecting the appropriate voice when a MIDI program change number is received. See "Program Change ON/OFF" on page 11 for information on turning program change number reception and transmission ON or OFF.

NO.	VOICE	NO.	VOICE
0	PIANO	8	PIANO + BASS
1	E.PIANO	9	E.PIANO + BASS
2	HARPSI	10	HARPSI + BASS
3	VIBES	11	VIBES + BASS
4	BRASS	12	BRASS + BASS
5	STRINGS	13	STRINGS + BASS
6	P.ORGAN	14	P.ORGAN + BASS
7	BASS	—	—

Control Change Numbers

Control Change data representing damper pedal operations is transmitted by the Personal Electronic Piano whenever the pedal is used. If the receiving device is a tone generator or another keyboard, it will respond in the same way as the Personal Electronic Piano's internal tone generator when these controls are used. The Personal Electronic Piano also receives and responds to these as well as some additional control change data described in the "MIDI DATA FORMAT" section of this manual. See "Control Change ON/OFF" on page 11 for information on turning control change number reception and transmission ON or OFF.

Note: None of the YPP-50 MIDI functions can be engaged while the built-in metronome is running.

MIDI Transmit & Receive Channel Selection

The MIDI system allows transmission and reception of MIDI data on 16 different channels. Multiple channels have been implemented to allow selective control of certain instruments or devices connected in series. For example, a single MIDI sequence recorder could be used to "play" two different instruments or tone generators. One of the instruments or tone generators could be set to receive only on channel 1, while the other is set to receive on channel 2. In this situation the first instrument or tone generator will respond only to channel-1 information transmitted by the sequence recorder, while the second instrument or tone generator will respond only to channel-2 information. This allows the sequence recorder to "play" two completely different parts on the receiving instruments or tone generators.

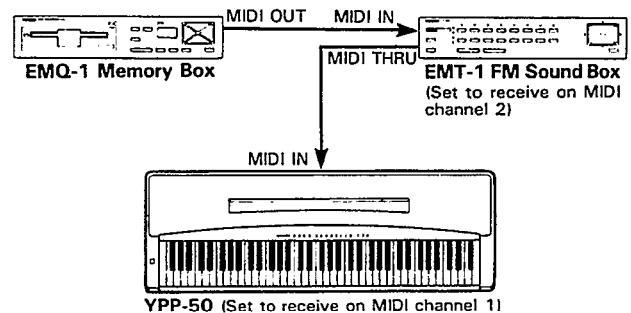

In any MIDI control setup, the MIDI channels of the transmitting and receiving equipment must be matched for proper data transfer. An "OMNI" receive mode is also available, which allows reception on all 16 MIDI channels. In the OMNI mode it is not necessary to match the receive channel of the receiving device to the transmit channel of the transmitting device (except when receiving mode messages).

Setting the Personal Electronic Piano MIDI Channels

1. Press and hold the MIDI/TRANSPOSE button.
2. Press the key on the keyboard corresponding to the desired MIDI transmit or receive channel.*
3. Release the MIDI/TRANSPOSE button.

* Keys C₁ through D#₂ on the keyboard are used to set the MIDI transmit channel, and keys C₃ through D#₄ are used to turn the OMNI mode OFF and set the MIDI receive channel as shown in the illustration below. The E₄ key sets the OMNI receive mode and basic receive channel 1.

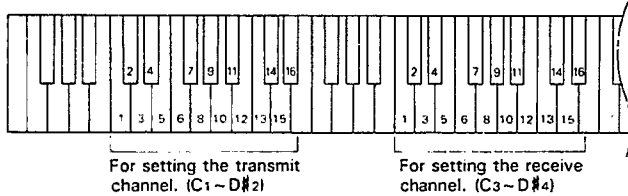

Note: When the power is initially turned ON, MIDI receive is set to the OMNI mode and the transmit channel is set to 1.

MIDI FUNCTION CHART

Function	Voice Selector*
Local ON/OFF	PIANO
Program Change ON/OFF	E.PIANO
Control Change ON/OFF	HARPSI
Multi-Timbre Mode	VIBES
Split & Left Local OFF	STRINGS
Split & Right Local OFF	BRASS
Panel Data Transmit	P.ORGAN

- The MIDI functions listed above are engaged by holding down the MIDI/TRANSPOSE button and pressing the corresponding voice selector. Full details are given in the following pages.

Local Control ON/OFF

“Local Control” refers to the fact that, normally, the Personal Electronic Piano keyboard controls its internal tone generator, allowing the internal voices to be played directly from the keyboard. This situation is “Local Control ON” since the internal tone generator is controlled locally by its own keyboard. Local control can be turned OFF, however, so that the Personal Electronic Piano keyboard does not play the internal voices, but the appropriate MIDI information is still transmitted via the MIDI OUT connector when notes are played on the keyboard. At the same time, the internal tone generator responds to MIDI information received via the MIDI IN connector. This means that while an external MIDI sequence recorder such as the Yamaha EMQ-1 Memory Box, for example, plays the Personal Electronic Piano’s internal voices, an external tone generator such as the EMT-1 can be played from the Personal Electronic Piano keyboard.

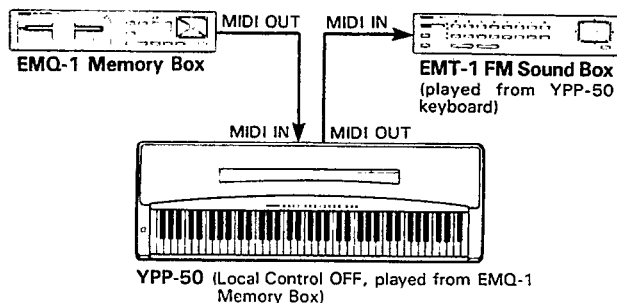

Turning Local Control ON or OFF

1. Hold down the MIDI/TRANSPOSE button.
2. Press the PIANO voice selector. If the PIANO LED is lit when the PIANO voice selector is pressed; you have turned local control OFF. If the PIANO LED is not lit when the PIANO voice selector is pressed, you have turned local control ON.
3. Release the MIDI/TRANSPOSE button.

Program Change ON/OFF

Normally the Personal Electronic Piano will respond to MIDI program change numbers received from an external keyboard or other MIDI device, causing the correspondingly numbered Personal Electronic Piano voice to be selected. The Personal Electronic Piano will normally also send a MIDI program change number whenever one of its voices is selected, causing the correspondingly numbered voice or program to be selected on the external MIDI device if the device is set up to receive and respond to MIDI program change numbers.

This function makes it possible to cancel program change number reception and transmission so that voices can be selected on the Personal Electronic Piano without affecting the external MIDI device, and vice versa.

1. Hold down the MIDI/TRANSPOSE button.
2. Press the E.PIANO voice selector. If the E.PIANO LED is lit when the E.PIANO voice selector is pressed, you have turned program change reception/transmission OFF. If the E.PIANO LED is not lit when the E.PIANO voice selector is pressed, you have turned program change reception/transmission ON.
3. Release the MIDI/TRANSPOSE button.

Control Change ON/OFF

Normally the Personal Electronic Piano will respond to MIDI control change data received from an external MIDI device or keyboard, causing the selected Personal Electronic Piano voice to be affected by pedal and other “control” settings received from the controlling device. The Personal Electronic Piano also transmits MIDI control change information when either of its pedals are operated.

This function makes it possible to cancel control change data reception and transmission if you do not want the Personal Electronic Piano voices to be affected by control change data received from an external device or vice versa.

1. Hold down the MIDI/TRANSPOSE button.
2. Press the HARPSI voice selector. If the HARPSI LED is lit when the HARPSI voice selector is pressed, you have turned control change reception/transmission OFF. If the HARPSI LED is not lit when the HARPSI voice selector is pressed, you have turned control change reception/transmission ON.
3. Release the MIDI/TRANSPOSE button.

The Multi-Timbre Mode

The Multi-Timbre mode is a special mode in which the Personal Electronic Piano voices can be independently controlled on different MIDI channel numbers (1 through 10) by an external MIDI device such as the Yamaha EMQ-1 Memory Box.

CHAN.	VOICE	CHAN.	VOICE
1	PIANO	6	STRINGS
2	E.PIANO	7	P.ORGAN
3	HARPSI	8	BASS
4	VIBES	9	PIANO
5	BRASS	10	PIANO

The Multi-Timbre mode can be activated as follows:

1. Hold down the MIDI/TRANPOSE button.
2. Press the VIBES voice selector. If the VIBES LED is lit when the VIBES voice selector is pressed, you have turned the Multi-Timbre mode ON. If the VIBES LED is not lit when the VIBES voice selector is pressed, you have turned the Multi-Timbre mode OFF.
3. Release the MIDI/TRANPOSE button.

Here's an example of how you could use the Multi-Timbre mode to record three different parts on the EMQ-1 Memory Box that will play different voices on the Personal Electronic Piano when played back.

1. Connect the EMQ-1 to the Personal Electronic Piano as shown below.

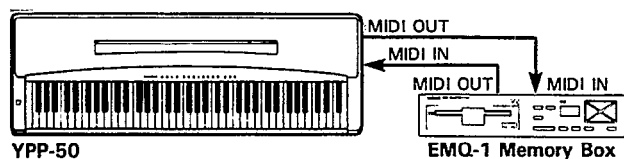

2. Select the first voice and MIDI transmit channel number, then record the first part on the EMQ-1.
3. Activate the Personal Electronic Piano Multi-Timbre mode, then select a new MIDI transmit channel and voice and record the second part on the EMQ-1 using its overdubbing function.
4. While still in the Multi-Timbre mode, select the third MIDI transmit channel and voice and record the third part on the EMQ-1 using its overdubbing function.
5. Still in the Multi-Timbre mode, play back the EMQ-1. The recorded parts will be played back using the individual voices selected during recording, providing a full ensemble sound.

The Split & Left Local OFF Mode

In the split mode one section of the Personal Electronic Piano keyboard is used to play a Personal Electronic Piano voice in the normal way, while the remaining section is used to play a second MIDI keyboard or tone generator such as the Yamaha EMT-1 FM Sound Box or EMT-10 AWM Sound Box. In this mode the right-hand section of the keyboard is used to play an internal Personal Electronic Piano voice, while the left-hand section of the keyboard plays the external keyboard or tone generator. Playing the left-hand section of the keyboard produces no sound from the Personal Electronic Piano. The "split point," or the key that divides the left- and right-hand sections of the keyboard, is automatically set at F#2.

The split mode is useful if, for example, you want to play a piano (Personal Electronic Piano) voice with the right hand while playing a synthesizer bass line or string section with the left hand.

When the split mode is activated, notes played on the left-hand section are transmitted via the Personal Electronic Piano MIDI OUT connector on MIDI channel 2. Notes played on the right-hand section are transmitted on the "basic channel" (i.e. the channel set using the MIDI channel selection function described previously). Damper pedal data is sent via both channels.

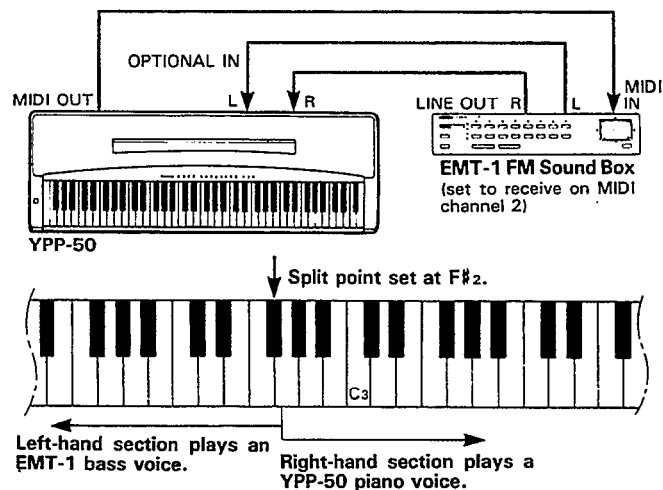

Activating the Split & Left Local OFF Mode

1. Hold down the MIDI/TRANPOSE button.
2. Press the STRINGS voice selector. If the STRINGS LED is lit when the STRINGS voice selector is pressed, you have turned the Split & Left Local OFF mode ON. If the STRINGS LED is not lit when the STRINGS voice selector is pressed, you have turned the Split & Left Local OFF mode OFF.
3. Release the MIDI/TRANPOSE button.

The Split & Right Local Off Mode

In the YPP-50 either the right- or left-hand section of the keyboard can be assigned to control an external keyboard or tone generator. Assigning the left-hand section to external tone generator control was described in the previous section. To assign the right-hand section to external tone generator control while playing the Personal Electronic Piano voices with the left hand, press the BRASS voice selector instead of the STRINGS voice selector when activating the Split mode (See "Activating the Split & Left Local OFF Mode" in the previous section). All other operations are exactly the same as described in the previous section.

Transmitting the Panel Settings

This function causes all the current Personal Electronic Piano control settings (selected voice, etc) to be transmitted via the MIDI OUT terminal. This is particularly useful if you will be recording performances to a MIDI sequence recorder* which will be used to control the Personal Electronic Piano on playback. By transmitting the Personal Electronic Piano panel settings and recording them on the MIDI sequence recorder prior to the actual performance data, the Personal Electronic Piano will be automatically restored to the same settings when the performance is played back.

* The Yamaha EMQ-1 Memory Box automatically receives and records the Personal Electronic Piano panel settings when a recording is begun, so this function is most useful with MIDI sequence recorders other than the EMQ-1.

1. Hold down the MIDI/TRANPOSE button.
2. Press the P.ORGAN voice selector.
3. Release the MIDI/TRANPOSE button.

TROUBLESHOOTING

If you encounter what appears to be a malfunction, please check the following points before assuming that your Personal Electronic Piano is faulty.

1. No Sound When the Power is Turned ON

Is the AC plug properly connected to an AC wall outlet? Check the AC connection carefully. Is the MASTER VOLUME control turned up to a reasonable listening level?

2. The Personal Electronic Piano Reproduces Radio or TV Sound

This can occur if there is a high-power transmitter in your vicinity. Contact your Yamaha dealer.

3. Intermittent Static Noise

This is usually due to turning ON or OFF a household appliance or other electronic equipment which is fed by the same AC mains line as your Personal Electronic Piano.

4. Interference Appears On Radio or TV Sets Located Near the Personal Electronic Piano

The Personal Electronic Piano contains digital circuitry which can generate radio-frequency noise. The solution is to move the Personal Electronic Piano further away from the affected equipment, or vice versa.

5. Distorted Sound When the Personal Electronic Piano is Connected to An External Amplifier/Speaker System

If the Personal Electronic Piano is connected to a stereo system or instrument amplifier and the sound is distorted, reduce the setting of the Personal Electronic Piano volume control to a level at which the distortion ceases.

OPTIONS & EXPANDER MODULES

OPTIONS

BC-7 Bench

A stable, comfortable bench styled to match your Yamaha Personal Electronic Piano.

HPed Stereo Headphones

High-performance lightweight dynamic headphones with extra-soft ear pads.

PCS-3 Connecting Cord

For connecting the Personal Electronic Piano to a stereo system or other audio equipment.

EXPANDER MODULES

- Sound Box EMT-10..... AWM Sound Expander
- Sound Box EMT-1..... FM Sound Expander
- Memory Box EMQ-1..... Disk Recorder
- Drum Box EMR-1..... Digital Drummer
- Reverb Box EME-1..... Digital Reverb

These state-of-the-art Expander Modules can dramatically expand the musical scope of your Personal Electronic Piano.

NOTE: Some items may not be available in certain areas.

MIDI DATA FORMAT

If you're already very familiar with MIDI, or are using a computer to control your music hardware with computer-generated MIDI messages, the data provided in this section can help you to control the Personal Electronic Piano.

1. NOTE ON/OFF

Data format: [9nH]->[kk]->[vv]

9nH = Note ON/OFF event (n = channel number)
kk = Note number (28~103=E0 ~ G6)
vv = Velocity (Key ON = 1~127. Key OFF= 0)

* Note OFF event format [8nH]->[kk] also recognized (reception only).

2. CONTROL CHANGE & MODE MESSAGES

Data format: [BnH]->[cc]->[dd]

BnH = Control event (n = channel number)
cc = Control number (or mode message number)
dd = Control value

cc	PARAMETER	dd
07H	Volume	0=OFF; 6FH=-3dB; 7FH=0dB
0BH	Expression	0=OFF; 6FH=-3dB; 7FH=0dB
40H	Damper pedal	0~3FH=OFF; 40H~7FH=ON
43H	Soft pedal	0~3FH=OFF; 40H~7FH=ON
79H	Reset all controllers	0
7AH	Local ON/OFF	0=OFF; 7FH=ON
7BH	All notes OFF	0
7CH	OMNI OFF/All notes OFF	0
7DH	OMNI ON/All notes OFF	0

* 43H, 79H, 7AH, 7BH, 7CH and 7DH are receive only.

3. PROGRAM CHANGE

Data format: [CnH]->[dd]

CnH = program event (n = channel number)
dd = Program number

dd	VOICE	dd	VOICE
00H	PIANO	08H	PIANO + BASS
01H	E.PIANO	09H	E.PIANO + BASS
02H	HARPSI	0AH	HARPSI + BASS
03H	VIBES	0BH	VIBES + BASS
04H	BRASS	0CH	BRASS + BASS
05H	STRINGS	0DH	STRINGS + BASS
06H	P.ORGAN	0EH	P.ORGAN + BASS
07H	BASS		

* No voice change is made when dd>0EH.

4. SYSTEM REALTIME MESSAGES

Active Sensing (FEH)

Transmitted every 200 milliseconds. If not received for more than 400 milliseconds a NOTE OFF occurs.

5. SYSTEM EXCLUSIVE MESSAGES

Data format: [F0H]->[43H]->[xn]->[ff]..... [F7H]

x=0, ff=7CH: Panel data dump. Panel data follows 7CH.
x=2, ff=7CH: Panel data request transmission.

Data format: [F0H]->[43H]->[73H]->[20H]->[nn]->[F7H]

43H = YAMAHA ID
73H = SINGLE KEYBOARD ID
20H = YPP-50 ID
nn = 40H: Performance play ON (receive only)
nn = 41H: Performance play OFF (receive only)
nn = 50H: Tempo UP
nn = 51H: Tempo DOWN
nn = 52H: Tempo 120

6. MULTI TIMBRE MODE

Data format: [F0H]->[43H]->[73H]->[id]->[nn]->[F7H]

43H = YAMAHA ID
73H = SINGLE KEYBOARD ID
id=01H (Standard), 1BH (Clavinova), or 20H (YPP-50)
nn=15H: MULTI TIMBRE mode ON; nn=13H: MULTI TIMBRE mode OFF; nn=7nH: Receive channel change (n = channel number. Receive only).

* All MIDI data available for general use are given above.

* Specifications subject to change without notice.

SPECIFICATIONS

	YPP-50
KEYBOARD	76 KEYS (E ₀ ~G ₆)
VOICE SELECTORS	PIANO, E.PIANO, HARPSICHORD, VIBES, STRINGS, BRASS, P.ORGAN, BASS
OTHER CONTROLS	MASTER VOLUME, MIDI/TRANSCOPE, METRONOME, TEMPO ▲ / ▼, PERFORMANCE MEMORY REC/PLAY, DEMO
JACKS/CONNECTORS	HEADPHONES, OPTIONAL IN L/R, OPTIONAL OUT L/R, MIDI IN/OUT, DAMPER
INPUT & OUTPUT LEVEL/IMPEDANCE	OPTIONAL OUT: 600 Ω/1~4 Vpp OPTIONAL IN: 22 kΩ/-10 dBm (for nominal output level)
MAIN AMPLIFIER	10 Watts
SPEAKERS	16 cm (6-2/7") x 2
DIMENSIONS (W x H x D) WEIGHT	1157 x 396 x 759 mm (45-6/9" x 15-3/5" x 28-8/9") 23 kg (50-5/7 lbs.)

YAMAHA [Personal Electronic Piano]
 Model YPP50 MIDI Implementation Chart

Date : 7/28, 1989
 Version : 1.0

Function	Transmitted	Recognized	Remarks
Basic Default	: 1	: 1	
Channel Changed	: 1-16	: 1-16	
Mode Default	: 3	: 1	
Mode Messages	: X : *****	: OMNIon, OMNIoff : X	
Note Number	: 28-103 : *****	: 28-103 : 28-103	
Velocity Note on	: O 9nH, v=1-127	: O v=1-127	
Velocity Note off	: X 9nH, v=0	: X	
After Touch Key's	: X	: X	
After Touch Ch's	: X	: X	
Pitch Bender	: X	: X	
Control Change	07 : X 11 : X 64 : O 67 : X 121 : X	: O : O : O : O : O	: Volume : Expression : Damper : Soft Pedal : Reset All : Controllers
Program Change	: O 0-14 : *****	: O 0-14 : 0-14	
System Exclusive	: O	: O	
System Common	: Song Pos : X : Song Sel : X : Tune : X	: X : X : X	
System Real Time	: Clock : X : Commands : X	: X : X	
Aux Messages	: Local ON/OFF : X : All Notes OFF : X : Active Sense : O : Reset : X	: O : O (123-125) *1 : O : X	
Notes : *1 = receive (123) if omni off or multi-timbre on			

Mode 1 : OMNI ON, POLY Mode 2 : OMNI ON, MONO O : Yes
 Mode 3 : OMNI OFF, POLY Mode 4 : OMNI OFF, MONO X : No

FCC INFORMATION (USA)

While the following statements are provided to comply with FCC Regulations in the United States, the corrective measures listed are applicable worldwide.

This series of Yamaha Personal Electronic Piano uses frequencies that appear in the radio frequency range, and if installed in the immediate proximity of some types of audio or video devices within three meters (approximately ten feet), interference may occur.

This series of Yamaha Personal Electronic Piano has been type-tested, and found to comply with the specifications set for a class B computer in accordance with those specifications listed in sub-part J, part 15 of the FCC rules. These rules are designed to provide a reasonable measure of protection against such interference. However, this does not guarantee that interference will not occur.

If your Personal Electronic Piano should be suspected of causing interference with other electronic devices, verification can be made by turning your Personal Electronic Piano off and on. If the interference continues when your Personal Electronic Piano is off, the Personal Electronic Piano is not the source of the interference. If your Personal Electronic Piano does appear to be the source of the interference, you should try to correct the situation by using one or more of the following measures:

- Relocate either the Personal Electronic Piano or the electronic device that is being affected by the interference.
- Utilize power outlets for the Personal Electronic Piano and the device being affected that are on different branch (circuit breaker or fuse) circuits, or install a/c line filters.
- In the case of radio-TV interference, relocate the antenna or, if the antenna lead-in is a 300 ohm ribbon lead, change the lead-in to coaxial type cable.

If these corrective measures do not produce satisfactory results, please contact a Yamaha dealer for suggestions and/or corrective measures. If you can not locate a Yamaha dealer in your general area, please contact the Service Division, Yamaha Corporation of America, 6600 Orangethorpe Ave., Buena Park, CA 90620, U.S.A.

If for any reason, you should need additional information relating to radio or TV interference, you may find a booklet prepared by the Federal Communications Commission helpful: "How to Identify and Resolve radio-TV Interference Problems." This booklet Stock #004-000-00345-4, is available from the U.S. Government Printing Office, Washington D.C. 20402.

* This applies only to products distributed by YAMAHA CORPORATION OF AMERICA

Wichtiger Hinweis für die Benutzung in der Bundesrepublik Deutschland.

Bescheinigung des Importeurs

Hiermit wird bescheinigt, daß der/die/das

Electronic Piano Typ: YPP-50

(Gerät, Typ, Bezeichnung)

in Übereinstimmung mit den Bestimmungen der
VERFÜGUNG 1046/84

(Amtsblattverfügung)

funk-entstört ist.

Der Deutschen Bundespost wurde das Inverkehrbringen dieses Gerätes angezeigt und die Berechtigung zur Überprüfung der Serie auf Einhaltung der Bestimmungen eingeräumt.

Yamaha Europa GmbH

Name des Importeurs

- Dies bezieht sich nur auf die von der YAMAHA EUROPA GmbH vertriebenen Produkte.

CANADA

THIS DIGITAL APPARATUS DOES NOT EXCEED THE "CLASS B" LIMITS FOR RADIO NOISE EMISSIONS FROM DIGITAL APPARATUS SET OUT IN THE RADIO INTERFERENCE REGULATION OF THE CANADIAN DEPARTMENT OF COMMUNICATIONS.

LE PRESENT APPAREIL NUMERIQUE N'EMET PAS DE BRUITS RADIO-ELECTRIQUES DEPASSANT LES LIMITES APPLICABLES AUX APPAREILS NUMERIQUES DE LA "CLASSE B" PRESCRITES DANS LE REGLEMENT SUR LE BROUILLAGE RADIOELECTRIQUE EDICTE PAR LE MINISTERE DES COMMUNICATIONS DU CANADA.

- This applies only to products distributed by Yamaha Canada Music Ltd.
- Ceci ne s'applique qu'aux produits distribués par Yamaha Canada Music Ltd.

YAMAHA

YAMAHA®

Yamaha Corporation of America
6600 Orangethorpe Avenue, P.O. Box 6600, Buena Park, CA 90622-6600

11/17/98 98109

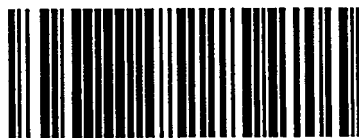

YPP50 OM



Recyclable



Recycled