

CS 5...

- Ⓧ Kaffee-Espresso-Vollautomat
- Ⓧ Fully Automatic Espresso Maker
- Ⓧ Machine à café/espresso entièrement automatique
- Ⓧ Volautomatische koffie- en espressomachine
- Ⓧ Macchina espresso automatica
- Ⓧ Máquina automática para Café Espresso
- Ⓧ Máquina de café Espresso- totalmente automática
- Ⓧ Kaffe-espresso helautomat
- Ⓧ Täysin automaattinen espressokahviasema
- Ⓧ Zcela automatický automat na espresso
- Ⓧ Automat do kawy espresso
- Ⓧ Kávéautomata
- Ⓧ Кофеварка-автомат
- Ⓧ Πλήρως αυτόματη μηχανή εσπρέσσο

Gebrauchsanweisung
Operating instructions

Mode d'emploi

Gebruiksaanwijzing

Istruzione per l'uso

Instrucciones de uso

Instruções de serviço

Bruksanvisning

Käyttöohje

Návod k použití

Instrukcja obsługi

Használati útmutató

Руководство по эксплуатации

Εγχειρίδιο οδηγιών χρήσης

CS 5000

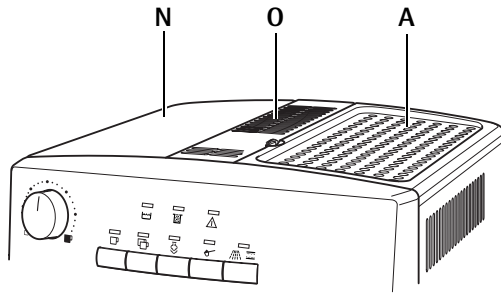

CS 5200

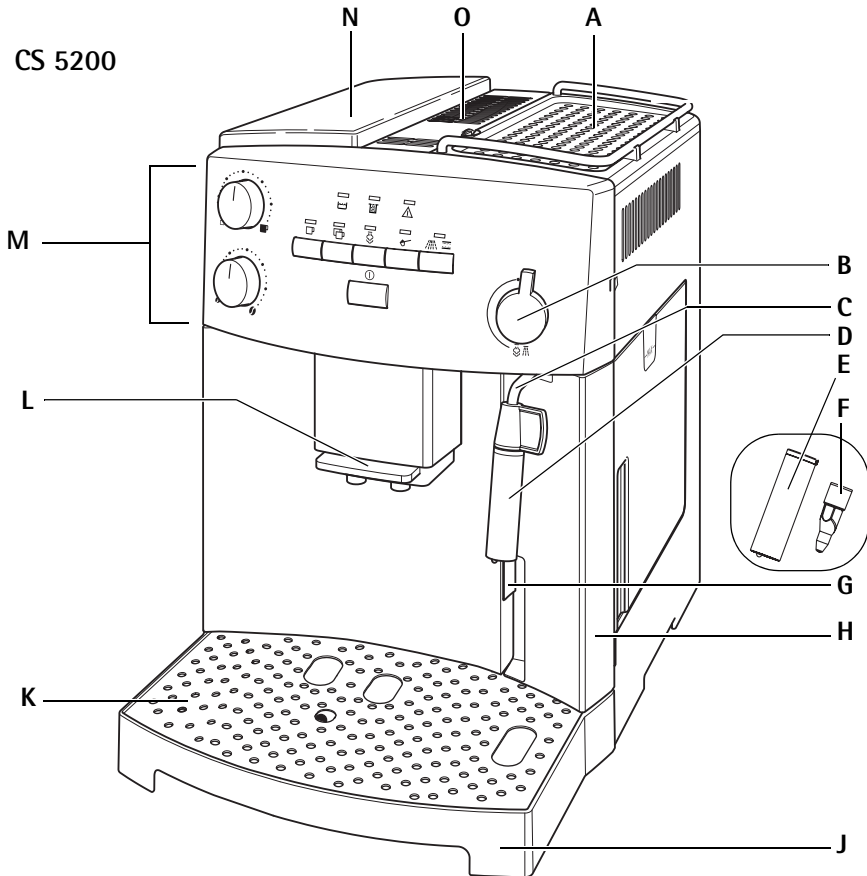

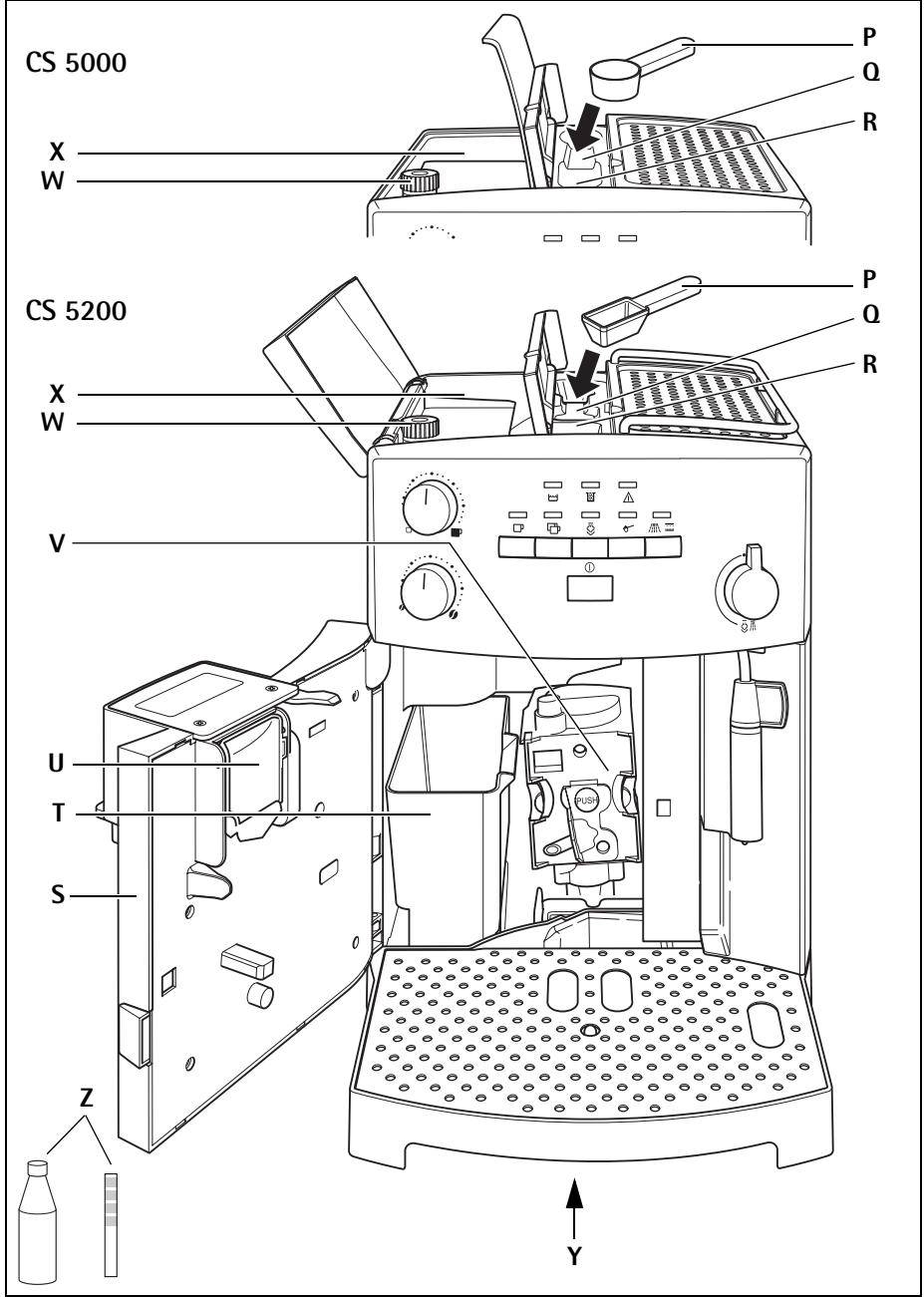

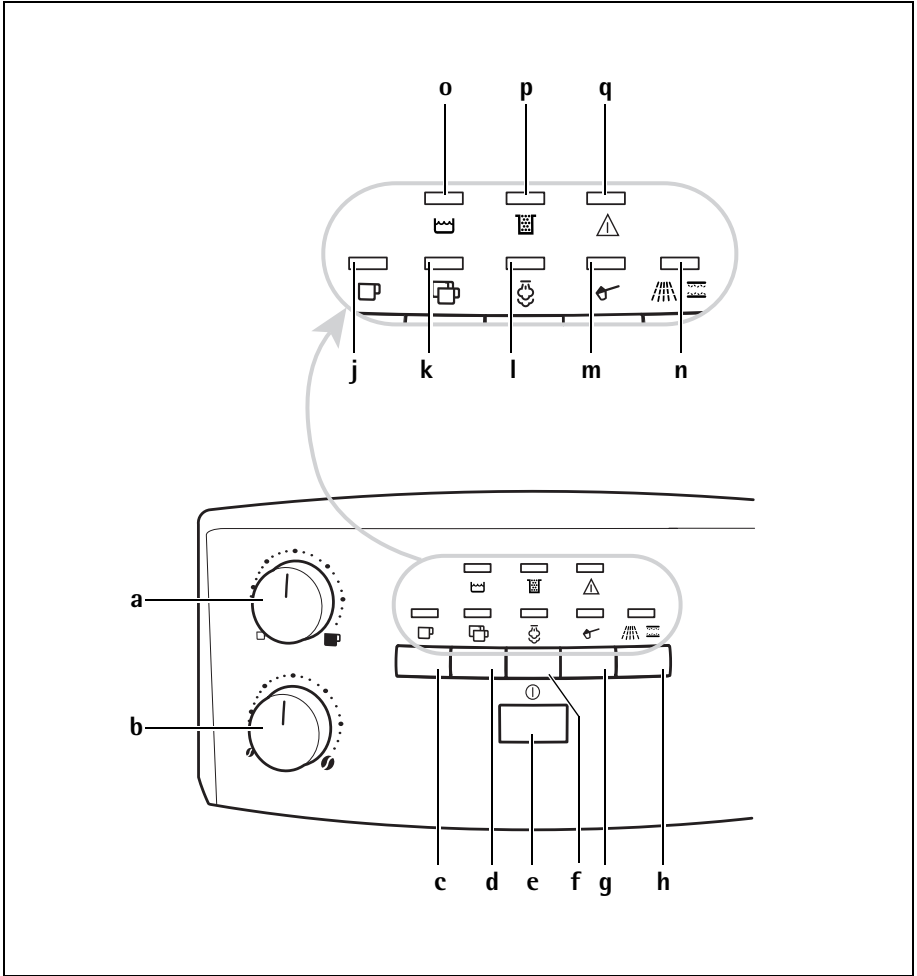

3

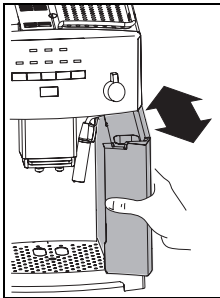

4

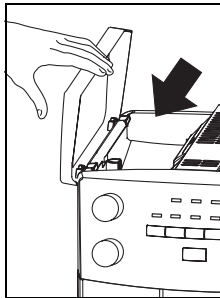

5

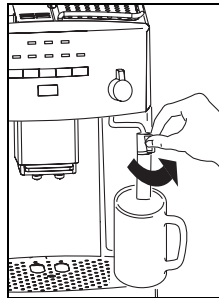

6

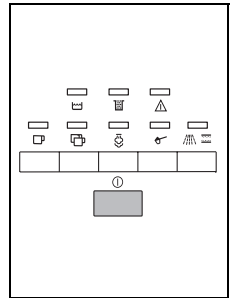

7

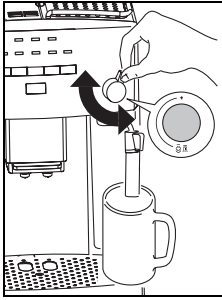

8

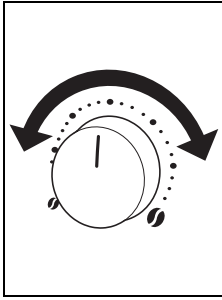

9

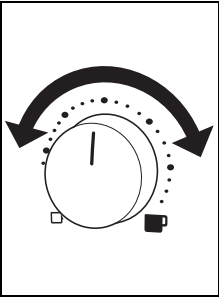

10

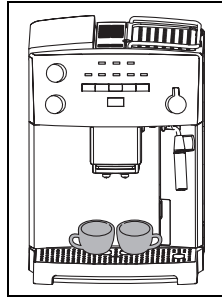

11

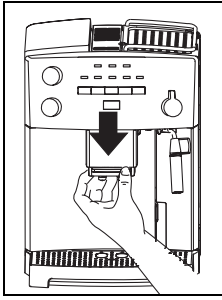

12

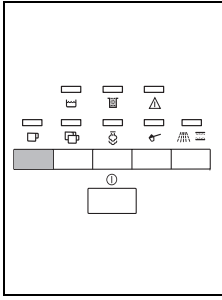

13

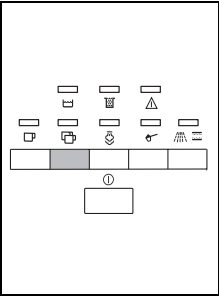

14

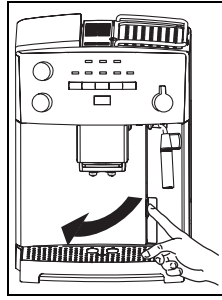

15

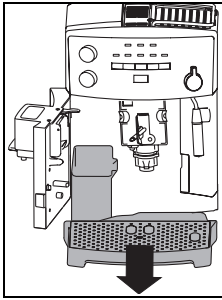

16

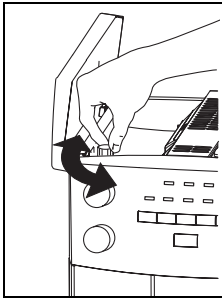

17

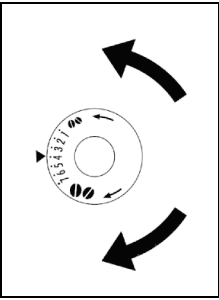

18

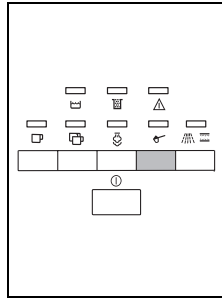

19

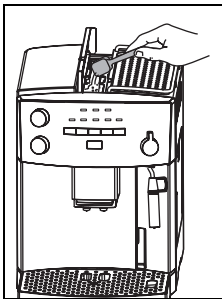

20

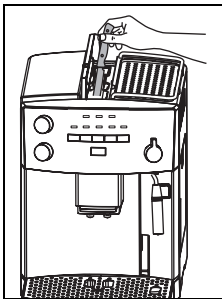

21

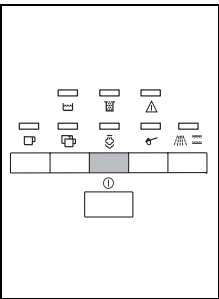

22

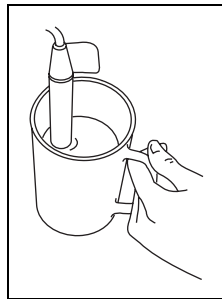

23

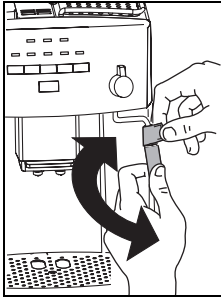

24

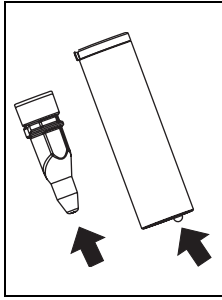

25

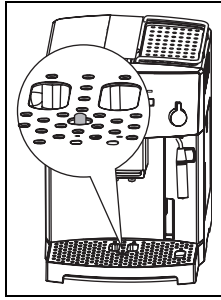

26

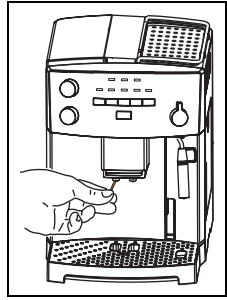

27

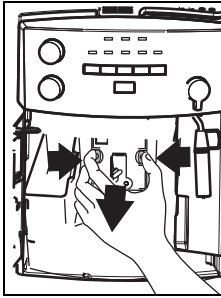

28

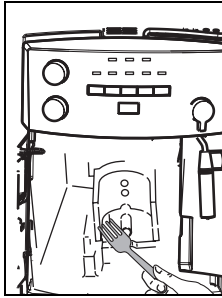

29

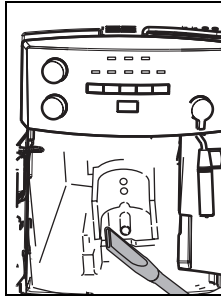

30

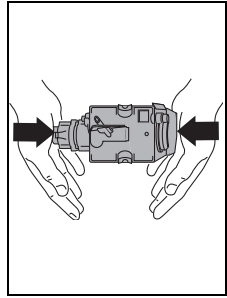

31

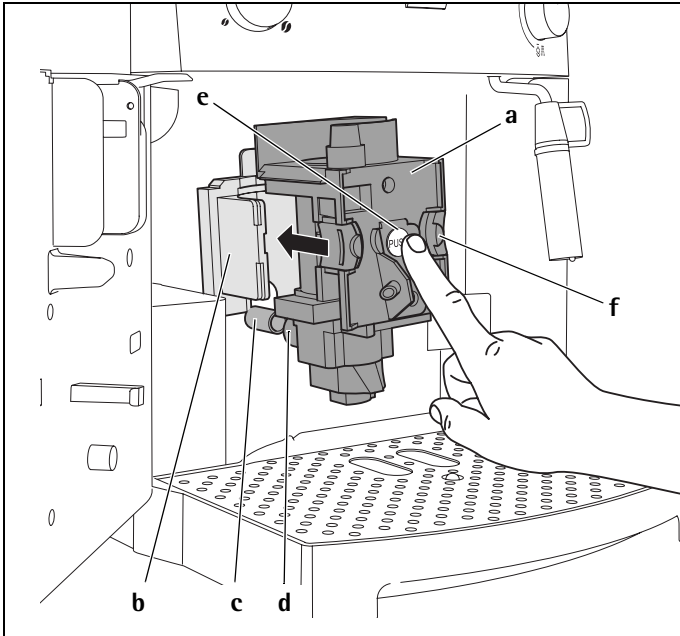

32

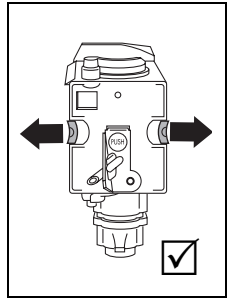

33

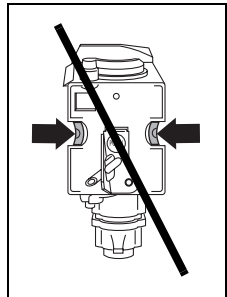

34

GB Dear Customer

Please read this user manual carefully, paying special attention to the safety notes! Keep the manual in a safe place for later reference, and pass it on to any new owner.

Contents

1	Figure captions	28	10	Meaning of the normal operation indicator lights	39
1.1	Front view (Fig. 1)	28	11	Meaning of the alarm indicator lights and what to do when they are on	39
1.2	Front view with open service door (Fig. 2)	28	12	Problems that can be resolved before calling the Customer Service Centre	41
1.3	Control panel (Fig. 3)	28	13	Technical Data	42
2	Safety Information	29	14	Disposal	43
3	Before using for the first time	30	15	If service is needed	43
3.1	Setting up and connecting the coffee machine	30			
3.2	Filling with water	31			
3.3	Filling the coffee bean container	31			
3.4	Switching on for the first time	31			
4	Making coffee with beans	32			
5	Adjusting the coffee grinder	34			
6	Using pre-ground coffee	34			
7	Preparing hot water	35			
8	Frothing milk	35			
8.1	Cleaning the milk frother	36			
9	Cleaning and Maintenance	36			
9.1	Cleaning the coffee maker	36			
9.2	Emptying the grounds container	36			
9.3	Cleaning the infuser	37			
9.4	Descaling	37			
9.5	Setting the water hardness	38			

1 Figure captions

i This manual is valid for the Fully Automatic Espresso Maker version CS 5000 and version CS 5200. The operation of both models is similar.

Figure 1 and figure 2 show both versions. All other illustrations show version CS 5200.

1.1 Front view (Fig. 1)

- A Cup warmer tray
- B Steam knob
- C Steam spout
- D Milk frother
- E Milk frother (removable)
- F Milk frother nozzle (removable)
- G Service door opening button
- H Water tank (removable)
- J Drip tray (removable)
- K Cup support tray
- L Coffee spout, adjustable in height
- M Control panel (see Fig. 3)
- N Bean container lid
- O Centre lid for the ground coffee

1.2 Front view with open service door (Fig. 2)

- P Measure for pre-ground coffee
- Q Compartment for the measure
- R Funnel for pre-ground coffee
- S Service door
- T Removable container for the coffee grounds
- U Mobile drawer
- V Infuser
- W Grinding coarseness adjustment knob
- X Container for the coffee beans
- Y Type plate (under appliance)
- Z Liquid descaler and Test strip for water hardness

1.3 Control panel (Fig. 3)

- a Coffee quantity selector knob (short, normal or long)
- b Grinding quantity selector knob (for weak, normal or strong coffee)
- c One cup button
- d Two cup button
- e On/off button
- f Steam function selector button
- g Ground coffee button (disables the coffee grinder)
- h Rinse and descaling button
- j 1 cup and coffee temperature OK light
- k 2 cup and coffee temperature OK light
- l Steam and steam temperature OK light
- m Ground coffee light (coffee grinder disabled)
- n Scale alarm light
- o No water or water tank absent indicator light
- p Grounds container full or absent indicator light
- q Generic alarm indicator light

2 Safety Information



This appliance conforms to accepted technological standards with regard to safety, and to the Appliance Safety Law. As the manufacturer, we nevertheless wish to familiarise you with the following safety information.

General safety

- The coffee machine must be connected only to a mains power current of which the voltage, type of supply and frequency conform to the details shown on the type plate (this can be found on the underside of the appliance)!
- Never allow the mains lead to come into contact with hot parts of the appliance.
- Never use the mains lead to pull the plug out of the mains socket!
- Do not use the coffee machine if:
 - the mains lead is damaged, or
 - the housing shows visible signs of damage.
- This appliance is not intended for use by people (including children) who, due to lack of experience or knowledge, are unable to operate it safely, or for use by people (including children) whose physical, sensory or mental capabilities are reduced, unless a person responsible for them has shown them how to use it safely, and has supervised them initially.

Child safety

- Do not leave the coffee machine running unattended, and take special care when children are about!
- Packaging material, e.g. plastic bags, should not be accessible to children.

Safety in operation

- **Caution! The coffee spout, milk frother and cup warmer tray become hot in operation. Keep children at a safe distance!**

- **Caution! Danger of scalding when the milk frother is activated! Hot water or steam output can cause scalding. Activate the milk frother only when you are holding a container under the nozzle.**
 - Do not use steam to heat inflammable liquids!
 - Only use the coffee machine with water in the system! Fill the water tank only with cold water. Do not use hot water, milk or other liquids. Do not exceed the maximum fill level of approx. 1.8 litres.
 - Do not put frozen or caramelised coffee beans in the bean container. Use only roasted coffee beans! Remove any foreign objects, such as small stones, from the coffee beans. Blocking or damage caused by foreign objects in the grinder might be excluded from the guarantee.
 - Spoon only ground coffee into the ground coffee funnel.
 - Do not leave the coffee machine switched on unnecessarily.
 - Do not expose the coffee machine to the effects of weather.
 - When using an extension lead, use only a commercially available cable with a conductor cross-section of at least 1.5 mm².
 - To avoid injury, people with motor system disorders should never use the machine without an accompanying person.
 - Operate the machine only when the drip tray, coffee grounds container and the cup support tray are installed!
- ### Safety in cleaning and care
- Follow the cleaning and descaling instructions.
 - Switch off the coffee machine and unplug it from the mains socket before carrying out any maintenance or cleaning!
 - Do not immerse the coffee machine in water.



- Only clean the milk frother when the machine is switched off, cold and not under pressure!
- Do not clean coffee machine parts in the dishwasher.
- **Never put water in the grinder.** This would damage the grinder.

Never open or repair the coffee machine. Faulty repairs can result in considerable hazard to the user.

Repairs to electrical appliances must be carried out only by qualified service engineers.

If a repair becomes necessary, including replacement of the mains lead, please contact

- the dealer where you bought the coffee machine, or
- the AEG/Electrolux Service Line.

If the machine is misused or incorrectly operated the manufacturer accepts no liability for damage and the guarantee is invalidated – likewise if the descaling program is not carried out in accordance with these operating instructions immediately after the   light flashes. Blocking or damage caused by foreign objects in the grinder might be excluded from the guarantee.

3 Before using for the first time

3.1 Setting up and connecting the coffee machine



After unpacking, make sure the appliance is complete and undamaged. If in doubt, do not use it. Contact professionally qualified personnel.



Place the appliance on a work surface far away from water taps, basins and sources of heat.



After having positioned the appliance on the work bench, make sure that there is a free space of around 5 cm between the surfaces of the appliance and the side and rear walls and a free space of at least 20 cm above the coffee maker.

Never install the machine in environments where the temperature may reach 0 °C or lower (the appliance may be damaged if the water freezes).



Check that the voltage of the mains power supply corresponds to the value indicated on the appliance's type plate. Only connect the appliance to a power outlet with a minimum rating of 10 A that is properly earthed. The manufacturer declines all liability for any accidents caused if the system is not correctly earthed.



If the power outlet does not match the plug on the appliance, have the outlet replaced with a suitable type by qualified personnel.



Plug the coffee machine into the power outlet.

If the coffee machine is plugged in for the very first time, all lights come on for a few seconds for a check, then all lights go off.





The water hardness should be set as soon as possible, following the procedure described in the section 9.5 „Setting the water hardness“, page 38.

-  To correctly learn how to use the machine, when starting it for the first time, carefully follow the step-by-step instructions described in the following paragraphs.

3.2 Filling with water

Each time before switching on the coffee machine, check that there is water in the water tank, and refill if necessary. The coffee machine requires water for the automatic rinsing processes each time the machine is switched on or off.



-  Remove the water tank (Fig. 4), rinse it and fill it with fresh water, without exceeding the MAX line. When removing the tank, the milk frother must always be positioned towards the centre of the machine, otherwise the tank cannot be removed.

-  Pour only fresh cold water into the water tank. Never put in other liquids, e.g. mineral water or milk.

-  Replace the tank, pushing it all the way in.

-  To always be sure of obtaining a rich coffee with a full aroma, you should:
- change the water in the water tank daily,
 - wash the water tank at least once a week in normal washing-up water (not in the dishwasher). Then rinse with fresh water.

3.3 Filling the coffee bean container

-  Open the lid on the coffee bean container (Fig. 5).
-  Fill the container with coffee beans.
-  Close the lid.



-  **Note!** Do not put frozen or caramelised coffee beans in the bean container. Use only roasted coffee beans! Make sure that no foreign objects, such as small stones, enter the coffee bean container. **Blocking or damage caused by foreign objects in the grinder might be excluded from the guarantee.**

-  Coffee has been used to factory-test the appliance, and it is therefore completely normal for there to be traces of coffee in the mill. This appliance is however guaranteed to be new.

3.4 Switching on for the first time

When you operate the machine for the first time, the coffee machine has to be vented.



-  Check that the water tank is full and that power cable is plugged into the power outlet.

-  Move the milk frother towards the outside and place a cup underneath (Fig. 6). Then turn the machine on by pressing the  button (Fig. 7).

-  **Immediately after, within a maximum of 30 seconds**, turn the steam knob anticlockwise until it stops (Fig. 8) (it is normal for the machine to make some noise).

After few seconds, a little water will come out of the milk frother.

-  When there is around 30 cc in the cup, turn the steam knob half a turn clockwise (Fig. 8) until it stops, so as to stop the water coming out.



-  Wait for the  and  lights to stop flashing and turn on steady. (When the lights are flashing it means that the machine is pre-heating, while when they are on steady it means that the machine has reached the ideal temperature for making coffee).

A few moments before the lights stop flashing the machine automatically performs a rinse cycle: a little hot water will come out of the delivery spouts and will be collected in the drip tray underneath.

-  **Tip:** for a hotter, short coffee (less than 60 cc), first fill the cup with the hot rinsing water. Then leave it inside for a few seconds (before emptying it) so as to pre-heat the cup.

At this point, the machine is ready for use.

4 Making coffee with beans

 Before delivering the coffee, always make sure that the  and  lights are on steady, and that the water tank and the coffee bean container are full.



 Adjust the grinding quantity selector knob (Fig. 9) to set the desired taste of the coffee.

Turning the knob clockwise increases the quantity of coffee beans that the machine will grind, and thus makes the taste of the coffee stronger. When using the machine for the first time, the correct position of the knob can be found by trial and error. Make sure not to turn it too far clockwise, otherwise the coffee will be delivered too slowly (in drops), above all when preparing two cups of coffee.

 Adjust the coffee quantity selector knob (Fig. 10) to set the quantity of coffee required.



Turning the knob clockwise makes a longer coffee. When using the machine for the first time, the correct position of the knob can be found by trial and error.



 Place one cup under the spouts to make 1 coffee or 2 cups for 2 coffees (Fig. 11). For a creamy coffee, lower the spouts to bring them as close to the cups as possible (Fig. 12).

 Press the button  (Fig. 13) to make one cup of coffee or the button  (Fig. 14) to make 2 coffees.

At this point the machine grinds the beans, runs a short pre-infusion cycle, a pause and then completes the delivery.

Once the desired quantity has been reached, the machine automatically stops delivering the coffee and discharges the grounds into the special container.

After a few seconds, when both the  and  indicator lights are on again, another coffee can be made.

 To switch the machine off, press the  button. (Before switching off, the machine automatically runs a rinse cycle: a little hot water will come out of the spouts and will be collected in the drip tray underneath - be careful, to avoid being scalded). If the machine is not switched off using the  button, it will switch itself off and run a brief rinse cycle 3 hours after the last operation.

 **Note 1:** If the coffee is delivered a drop at a time or not at all, turn the grinding coarseness regulator (Fig. 17) one click clockwise (see section 5 „Adjusting the coffee grinder“, page 34). Turn a click at a time until the coffee is delivered satisfactorily.

 **The grinder setting may be changed only while coffee is being ground. Making adjustments to the stationary grinder can damage the coffee machine.**

 **NOTE 2:** If the coffee is delivered too fast and is not creamy enough, turn the grinding quantity selector knob (Fig. 9) clockwise. Proceed by trial and error to find the correct position of the knob. Make sure not to turn the knob too far clockwise, otherwise the delivery may become too slow (in drops), above all when making two cups of coffee. If, after several coffees, the cream is still not satisfactory, also turn the grinding adjustment knob (Fig. 17) one click anticlockwise (see section 5 „Adjusting the coffee grinder“, page 34).



 **Note 3: Tips on making hotter coffee:**



- 1) If, when the machine has just been turned on, a short cup of coffee is required (less than 60 cc), use the hot rinsing water to pre-heat the cups.
- 2) If, on the other hand, more than 2 or 3 minutes have elapsed since the last coffee was made, before preparing another coffee the infuser must be pre-heated, pressing the  button.

Then let the water flow out into the drip tray underneath, or alternatively use this water to fill (and then empty) the cup to be used for the coffee, so as to pre-heat it.

3) Unless preheated, do not use cups that are too thick, as they will absorb too much heat.

4) Use cups that have been previously heated by rinsing them with hot water or alternatively by leaving them for at least 20 minutes on the cup warmer tray on top of the machine with the appliance on.

i **Note 4:** while the machine is making the coffee, the delivery can be stopped at any time by pressing the  button (Fig. 13) or  button (Fig. 14), or by turning the coffee quantity selector knob (Fig. 10) anti-clockwise.

i **Note 5:** as soon as delivery is complete, to increase the quantity of coffee, simply press and hold the  button (Fig. 13) or  button (Fig. 14), until reaching the desired quantity, or turn the coffee quantity selector knob (Fig. 10) clockwise (this operation must be performed immediately after the coffee is dispensed and before the coffee grounds are ejected into the grounds container).

i **Note 6:** when the  alarm comes on, the water tank must be filled, otherwise the coffee cannot be made. The water tank can only be removed if the milk frother is first positioned towards the centre of the machine. (It is normal for there to be a little water left in the tank when the alarm comes on).

i **Note 7:** the machine counts the number of cups of coffee made. Each 14 single cups (or 7 double cups), the  light switches on steady, warning the user that the grounds container is full and must be emptied and cleaned, see 9.2 „Emptying the grounds container“, page 36.

i **Note 8:** the grinder in the coffee maker may become worn over time and consequently the coffee will change taste as it is ground more coarsely.

To resolve this problem, re-set the grinding coarseness on the coffee grinder by adjusting the knob (Fig. 17) one click anticlockwise (as described in section 5 „Adjusting the coffee grinder“, page 34).

i **Note 9:** if the machine is not used for a long period, the infuser must be cleaned, as described in section 9.3 „Cleaning the infuser“, page 37.

i **Note 10:** while the machine is delivering coffee, never remove the water tank. If it is removed, the machine will not be able to make the coffee and the "no water" light  will flash. If you try and make another coffee, the machine becomes noisy and does not make the coffee. To reset the machine, turn the steam knob anticlockwise as far as it will go and run off water from the milk frother for a few seconds.

i When using the machine for the first time, 4-5 cups of coffee made before the machine starts to give satisfying results.

i When an alarm light comes on to signal an anomaly, do not contact the service centre straight away. The problems can almost always be resolved by following the instructions indicated in section 11 „Meaning of the alarm indicator lights and what to do when they are on“, page 39 and section 12 „Problems that can be resolved before calling the Customer Service Centre“, page 41. If necessary, contact the Customer Service Centre.

5 Adjusting the coffee grinder

The coffee grinder must not be adjusted, at least initially, as it has already been pre-set in the factory for the correct delivery of the coffee.

Nonetheless, after having made the first coffees, if delivery is too fast or too slow (in drops), the grinding coarseness must be adjusted using the knob (Fig.17) located inside the bean container.

These adjustments will only be evident after the delivery of at least 2 cups of coffee.



The grinder setting may be changed only while coffee is being ground. Making adjustments to the stationary grinder can damage the coffee machine.



Turn one click (one number) anticlockwise for finer ground coffee and consequently slower delivery and a creamier appearance (Fig. 18).



Turn one click (one number) clockwise for coarser ground coffee and consequently faster delivery (not a drop at a time) (Fig. 18).



The machine has been tested in the factory using coffee and therefore it is completely normal to find some traces of coffee in the grinder. The machine is in any case guaranteed to be new.

6 Using pre-ground coffee



Press the  button to select the ground coffee function (Fig. 19).

The  light switches on to indicate that the function has been selected and the coffee grinder has been disabled.



Lift the lid in the centre, insert one (for 1 cup) or two (for 2 cups) pre-ground coffee measures in the funnel (Fig. 20).





Adjust the coffee quantity selector knob (Fig. 10) to set the quantity of coffee required.

Turning the knob clockwise makes a longer coffee.



Place one cup under the spouts to make 1 coffee or 2 cups for 2 coffees (Fig. 11). For a creamy coffee, lower the spouts to bring them as close to the cups as possible (Fig. 12).



Press the button  (Fig. 13) to make one cup of coffee or the button  (Fig. 14) to make 2 coffees.



Note 1: Never add the ground coffee when the machine is off, to prevent it from spilling inside the machine.



Note 2: Never add more than 2 measures, otherwise either the machine will not make the coffee and the pre-ground coffee will be lost inside the machine, dirtying it, or the coffee will be run off in drips.



Note 3: When dosing the quantity of coffee to be added, only use the measure supplied.



Note 4: Only use ground coffee for espresso coffee makers: do not use coffee beans, freeze-dried coffee or other materials that may damage the machine.



Note 5: If you add more than two measures of pre-ground coffee and the funnel blocks, use a knife to push the coffee down (Fig. 21) and then remove and clean the infuser and the machine, as described in section 9.3 „Cleaning the infuser“, page 37.









Once the coffee has been delivered, to make coffee using the beans again, deactivate the ground coffee function by pressing the  button again (the light goes off and the coffee grinder is enabled for operation again).













Please observe also section 4 „Making coffee with beans“, page 32, notes no. 3 - 7, 9 and 10.

7 Preparing hot water

-  Always make sure that the  and  lights are on steady.
-  Turn the milk frother towards the outside of the machine (Fig. 6).
-  Position a container underneath the milk frother (Fig. 6).
-  Turn the steam knob half a turn anticlockwise until it stops (Fig. 8): hot water will come out of the milk frother and start to fill the container underneath.
-  To stop the flow of hot water, turn the steam knob all the way clockwise (Fig. 8) and return the milk frother to the original position towards the centre of the machine. (It is recommended to deliver hot water for no more than 2 minutes).

8 Frothing milk

-  Fill a container with around 100 grams of milk for each cappuccino being prepared. When choosing the size of the container, remember that the volume will increase by 2 or 3 times.
-  It is recommended to use partially skimmed milk at fridge temperature.
-  Move the milk frother towards the outside (Fig. 6).
-  Prepare the espresso coffee as described in the corresponding sections, using sufficiently large cups.
-  Then press the steam button  (Fig. 22).
The  light starts flashing to indicate that the machine is heating up (the  and  lights remain off to indicate that it is not possible to make coffee). When the  light remains on steady and stops flashing, the temperature of the machine has reached the ideal value for making the steam.
-  Immediately after, within a maximum of two minutes (otherwise the machine automatically returns to the coffee function), dip the milk frother into the

container of milk (Fig. 23), and turn the steam knob half a turn anticlockwise until it stops (Fig. 8).





Be careful, to avoid being scalded.







Attention! Risk of impurities from dried on milk residues in the milk frother. Take care not to immerse the milk frother in the milk far enough to cover the air intake opening at the top of the milk frother. Otherwise milk can be sucked into the nozzle and cause impurities in the milk frother.

The steam released will make the milk froth and increase in volume. To make creamier foam, dip the milk frother into the milk and rotate the container with slow movements from the bottom to the top (you are recommended to limit steam delivery to no more than two minutes at a time).

-  Once having reached the desired temperature, stop the steam by turning the steam knob clockwise until it stops (Fig. 8) and then press the  steam button (Fig. 22) to deactivate the steam function.
-  Pour the frothed milk into the cups containing the espresso coffee prepared previously. The cappuccino is now ready (add sugar to taste and if desired, sprinkle the foam with a little cocoa powder).



Note 1: immediately after having prepared the cappuccino, once having pressed the steam button  (Fig. 22) to deactivate the function, the machine is too hot to make coffee (the  and  lights flash to indicate that the temperature is not suitable); simply wait around 10 minutes for the machine to cool down a little.

Hint: To cool it down more quickly, after having deactivated the steam function, open the steam knob and release some water from the milk frother into a container, until the  and  lights stop flashing.

8.1 Cleaning the milk frother

The milk frother must always be cleaned after use.

-  Release a little steam for a few seconds by turning the steam knob anticlockwise until it stops (Fig. 8).

With this operation, the steam spout discharges any milk that may be left inside.

-  **Important:** For reasons of hygiene, this operation should always be performed, so as to prevent the milk from remaining in the circuits inside the milk frother.

-  Turn the knob clockwise as far as it will go. Wait a couple of minutes for the milk frother to cool down.

-  With one hand, hold the steam spout handle firm and with the other disengage the bayonet connection of the milk frother by turning it slightly clockwise. Extract the milk frother downwards (Fig. 24).

-  Remove the milk frother nozzle from the delivery spout by pulling it downwards.

-  Carefully wash the milk frother and the nozzle in warm water.

-  Check that the two holes indicated by the arrows in Fig. 25 are not clogged. If necessary, clean them using a needle or pin.

-  Replace the milk frother nozzle by inserting it and vigorously turning it upwards onto the steam spout.

-  Replace the milk frother by pushing it upwards and turning it anticlockwise (Fig. 24).

9 Cleaning and Maintenance





Before performing any cleaning operations, the machine must have cooled down and must be disconnected from the mains power supply.

Never immerse the machine in the water: it is an electrical appliance.

Do not use solvents or abrasive detergents to clean the coffee maker. A soft damp cloth will suffice.

All the components of the machine must not be washed in the dishwasher.

9.1 Cleaning the coffee maker

-  Clean the grounds container (as described in section 9.2 „Emptying the grounds container“, page 36) whenever the  light comes on steady.



-  The water tank should be cleaned regularly.

-  The drip tray is fitted with a level indicator (red) (Fig. 26) showing the level of water inside. When the indicator starts to become visible (a few millimetres under the drip tray), the drip tray must be emptied and cleaned.

-  Check that the holes in the coffee delivery spout are not blocked. To clean them, scrape the dry coffee residues with a needle (Fig. 27).

9.2 Emptying the grounds container

The appliance counts the number of coffees made. Every 14 single coffees (or 7 doubles) the  light comes on to indicate that the grounds container is full and must be emptied and cleaned. Until the grounds container has been cleaned, the appliance cannot make coffee.

-  To clean it, unlock and open the service door by pushing the respective button (Fig. 15), the  light flashes.

-  Then remove the drip tray (Fig. 16), and empty and clean it.





-  Empty the grounds container and clean it thoroughly, making sure that all residues deposited on the bottom are removed.

Important: Each time you pull out the drip tray, the grounds container **must** also be emptied, even if it is not completely full. If this is not done, when coffee is next made, the grounds in the container may exceed the maximum level and block the appliance.





-  When the coffee machine is in daily use, empty the container daily. Always empty the container with the coffee machine switched on, otherwise the coffee machine does not register that the container has been emptied.

9.3 Cleaning the infuser

The infuser must be cleaned regularly to prevent it from filling with coffee deposits (that may lead to malfunctions). To clean it, proceed as follows:

-  Turn the machine off by pressing the  button (Fig. 4) (do not unplug it) and wait for all the indicator lights to go off.
-  Open the service door (Fig. 15).
-  Remove the drip tray and the grounds container (Fig. 16) and clean them.
-  Press the two red release buttons on the infuser sideways and towards the centre (Fig. 28) and pull it out.

 **Warning: the infuser can only be removed when the machine is off. Attempting to remove the infuser with the machine on will risk causing damage.**

-  Wash the infuser under running water, without using detergents.
-  Never wash the infuser in the dishwasher.
-  Carefully clean the inside of the machine. To remove the coffee stuck to the parts inside the machine, scrape it with a plastic or wooden fork (Fig. 29) and then pick up all the residues using a vacuum cleaner (Fig. 30).
-  Replace the infuser (Fig. 32, a) by pushing it onto the holder (Fig. 32, b) and pushing in the pin (Fig. 32, c). The

pin must be inserted into the pipe at the bottom of the infuser (Fig. 32, d).







-  Then push the PUSH symbol (Fig. 32, e) fully in until hearing the click.
-  Check that the two red buttons (Fig. 32, f) have opened back out, otherwise the door cannot close.

Fig. 33: The two red buttons have snapped out correctly.



Fig. 34: The two red buttons have not snapped out.









-  **Note 1:** If the infuser is not inserted correctly until hearing the click and the two red buttons have not opened out properly, the service door will not close and the machine will not operate (when switching on the machine the  light starts flashing).

-  **Note 2:** if it is hard to insert the infuser, (before inserting it) squeeze it into size by pressing it vigorously from above and below at the same time, as shown in Figure 31.

-  **Note 3:** if it is still hard to insert the infuser, leave it out of the machine, close the service door, unplug from the mains then plug in again. Wait for all the lights to go off, then open the door and replace the infuser. Then replace the drip tray, complete with the grounds container, and close the service door.





9.4 Descaling

Due to the continuous heating of the water used to make the coffee, over time it is normal for the tubing inside the machine to fill with lime scale. When the   light starts flashing, it is time to descale the machine.



-  **Note:** when the   light switches on, the coffee maker can still be used to prepare coffee. Proceed as follows:
-  Turn the machine on by pressing the  button (Fig. 7).
-  Wait for the  and  indicator lights to come on steady.

- ☞ Prepare the solution as indicated on the packaging of the descaling product supplied with the coffee maker.: Pour the contents of the bottle of descaler (approx. 0.125 litres) into the water tank and then add 1 litre water.



 **Important:** Do not under any circumstances use any descalers which are not recommended by AEG/Electrolux. If other descaling agents are used, AEG/Electrolux accepts no liability for any damage. You can obtain descaling liquid from specialist retailers or from the AEG/Electrolux Service Line.

- ☞ Place a container with a minimum capacity of 1.5 litres under the milk frother (Fig. 6).
- ☞ Press and hold the  button for at least 5 seconds. The  light switches on to indicate the start of the descaling program (the  and  lights remain off to indicate that it is not possible to make coffee).
- ☞ Turn the steam knob half a turn anti-clockwise (Fig. 8). The descaling solution will come out of the milk frother and start to fill the container underneath.
- ☞ The descaling program automatically performs a series of deliveries and pauses, so as to remove the lime scale deposits from inside the coffee maker.
- ☞ After around 30 minutes, when the  light comes on, turn the steam knob half a turn clockwise (Fig. 8) until it stops.
The machine must be rinsed so as to eliminate the residues of descaling solution from inside the machine.
- ☞ Remove the water tank, rinse it and fill it with clean water.
- ☞ Reposition the tank.
- ☞ Empty the collection container (located under the milk frother) that is full of liquid, and then replace it under the milk frother.
- ☞ Turn the steam knob half a turn anti-clockwise (Fig. 8). Hot water will come

out of the milk frother and fill the container underneath.

- ☞ When the tank is empty, the  light goes off and the  light comes on.
- ☞ Turn the steam knob all the way clockwise (Fig. 8) and fill the water tank with clean water again.

The program of descaling is now terminated and the machine is ready to do again the coffee.

 **Note:** if the descaling procedure is stopped before completion, the  alarm is not deactivated and the procedure must be started again from the beginning.

 **Important:** the guarantee is not valid if the above descaling operation is not performed regularly.

9.5 Setting the water hardness

The  light switches on after a preset period of operation, set in the factory, considering the maximum quantity of lime scale that may be contained in the mains water. If necessary, this period of operation can be extended, thus making the descaling operation less frequent, by programming the machine based on the actual lime content in the water used. You can use the enclosed test strip to determine the water hardness, or contact your local water supply company.

Determining water hardness

- ☞ Dip the test strip in cold water for around 1 second. Shake off the excess water, and gauge the hardness by means of the pink bands.

 **No pink bands or one pink band:**
Hardness level 1, soft
up to 1.24 mmol/l, or
up to 7° German hardness, or
up to 12.6° French hardness

 **Two pink bands:**
Hardness level 2, medium hard
up to 2.5 mmol/l, or
up to 14° German hardness, or
up to 25.2° French hardness

















Three pink bands:
Hardness level 3, hard
 up to 3.7 mmol/l, or
 up to 21° German hardness, or
 up to 37.8° French hardness



Four pink bands:
Hardness level 4, very hard
 over 3.7 mmol/l or
 over 21° German hardness, or
 over 37.8° French hardness

Setting and saving the water hardness level

You can set 4 hardness levels. The coffee machine is factory-set to hardness level 4.

-  Check that the machine is off (all the indicator lights are off).
-  Press the  button and hold it for at least 5 seconds. The four lights , ,  and  come on.
-  Press the  button (Fig. 19) repeatedly until the number of lights that are on coincides with the hardness level (for example, to set hardness level 3, press the button until 3 indicator lights come on together, ,  and ).
-  Press the  button to save the data. The coffee maker is now programmed to provide the descaling warning when effectively necessary, based on the actual hardness of the water.

10 Meaning of the normal operation indicator lights

The and indicator lights are flashing

The machine is not ready to make coffee (the ideal water temperature has not yet been reached). Wait for the indicator lights to come on steady before making the coffee.

The and indicator lights are on steady

The machine is at the right temperature and ready to make coffee.

The light is on steady

The machine is delivering one cup of coffee.

The light is on steady

The machine is delivering two cups of coffee.

The steam light flashes

The machine is heating to the ideal temperature to produce steam. Wait for the light to come on steady before turning the steam knob.

The steam light is on steady

The machine is ready to deliver steam and the steam knob can be turned.

The light is on steady

The machine is ready for delivery using ground coffee (see section 6 „Using pre-ground coffee“, page 34).

The light is on steady

The automatic descaling program is in progress (see section 9.4 „Descaling“, page 37).

11 Meaning of the alarm indicator lights and what to do when they are on

The light is on steady

- The water tank is empty or is positioned incorrectly.

 Fill the water tank as described in section 3.2 „Filling with water“, page 31, and insert it fully.

- The tank is dirty or lined with lime scale.

 Rinse or descale the tank.

The light flashes

- The machine cannot make the coffee and is noisy.

 Turn the steam knob anticlockwise (Fig. 8) as described in section 4 „Making coffee with beans“, page 32, note 10.

- The coffee comes out too slowly.

 Turn the grinding adjustment knob (Fig. 17) one click clockwise (section 5 „Adjusting the coffee grinder“, page 34).

The ☒ light is on steady

- The coffee grounds container is full or not in place.
- ☞ Empty the grounds container and clean it as described in section 9.2 „Emptying the grounds container“, page 36, then insert it fully.
- The grounds container has not been replaced after cleaning.
- ☞ Open the service door and replace the grounds container.

The ☒ light flashes

- The ground coffee has not been poured into the funnel with the ☞ function selected.
- ☞ Add the ground coffee as described in section 6 „Using pre-ground coffee“, page 34.
- No more coffee beans.
- ☞ Fill the container with beans, as described in section 3.3 „Filling the coffee bean container“, page 31.
- If the coffee grinder is very noisy, it means that a small stone in the coffee beans has blocked the coffee grinder.
- ☞ Contact the Customer Service Centre. **Blocking or damage caused by foreign objects in the grinder might be excluded from the guarantee.**

The ☒ light flashes

- This indicates the presence of lime scale in the machine.
- ☞ The descaling procedure, described in section 9.4 „Descaling“, page 37, needs to be performed as soon as possible.

The machine makes a strange noise and the four lights ☒, ☒, ☒ and ☒ flash alternately

- After cleaning, the infuser has probably been left out of the coffee maker.
- ☞ Leave the service door closed and the infuser out of the coffee maker. Press the ☒ and ☒ buttons together until the four lights go off. Only when all four lights are off can the door be opened and the infuser inserted (to insert the infuser see section 9.3 „Cleaning the infuser“, page 37).

The ☒ and ☒ lights flash alternately

- The machine has just been switched on and the infuser is not inserted correctly, consequently the door is not closed properly.
- ☞ Press the infuser where marked PUSH until hearing the click. Check that the two red buttons open out correctly (section 9.3 „Cleaning the infuser“, page 37). Close the service door and press the ⓪ button.

The ☒, ☒ and ☒ lights are on and flashing

- The machine has been switched on with the steam knob in the open position.
- ☞ Turn the steam knob clockwise all the way round (Fig. 8).

The ☒ light is flashing

- The service door is open.
- ☞ If the service door cannot be closed, check that the infuser is inserted correctly (section 9.3 „Cleaning the infuser“, page 37).

The ☒ light is on steady and the ☒ and ☒ lights are flashing

- After cleaning, the infuser has probably been left out of the coffee maker.
- ☞ Insert the infuser, see section 9.3 „Cleaning the infuser“, page 37.
- The inside of the machine is very dirty.
- ☞ Thoroughly clean the inside of the machine, as described in section 9.3 „Cleaning the infuser“, page 37.



The ☞ light is flashing

- The ground coffee funnel is clogged.
- ☞ Empty the funnel with the help of a knife, as described in section 6 „Using pre-ground coffee“, page 34, note 5 (Fig. 21).



12 Problems that can be resolved before calling the Customer Service Centre

If the machine is not working and an alarm light is on, the causes of the malfunction can be identified and resolved by referring to chap. 11. If, on the other hand, no alarm light is on, run the following checks before calling the Customer Service Centre.

The coffee is not hot

- The cups have not been preheated.
-  Pre-heat the cups by rinsing them in hot water or leaving them for at least 20 minutes on the cup warmer tray (A) (see section 4 „Making coffee with beans“, page 32, note 3).
- The infuser is too cold.
-  Heat the infuser by pressing the  button before making the coffee (see section 4 „Making coffee with beans“, page 32, note 3).

The coffee is not creamy enough



- The machine uses too little coffee during the infusion process.
-  Turn the grinding quantity selector knob (Fig. 9) a little clockwise (see section 4 „Making coffee with beans“, page 32, note 2).
- The coffee is ground too coarse.
-  Turn the grinding adjustment knob (Fig. 17) one click anticlockwise (see section 5 „Adjusting the coffee grinder“, page 34).
- Wrong type of coffee.
-  Use a type of coffee for fully automated espresso makers.

The coffee comes out too slowly

- The coffee is ground too fine.
-  Turn the grinding adjustment knob (Fig. 17) one click clockwise (see section 5 „Adjusting the coffee grinder“, page 34).
- The machine uses too much coffee during the infusion process.

-  Turn the grinding quantity selector knob (Fig. 9) a little anticlockwise.

The coffee comes out too quickly

- The coffee is ground too coarse.
-  Turn the grinding adjustment knob (Fig. 17) one click anticlockwise (see section 5 „Adjusting the coffee grinder“, page 34).
- The machine uses too little coffee during infusion.
-  Turn the grinding quantity selector knob (Fig. 9) a little clockwise.

The coffee does not come out of one of the spouts

- The outlet is blocked.
-  Scrape the remains of dry coffee accumulated with a needle (Fig. 27).

Turning the steam knob, no steam comes out of the milk frother

- The holes in the spouts are clogged.
-  Clean the holes in the milk frother and the milk frother nozzle (see section 8.1 „Cleaning the milk frother“, page 36 - Fig. 25).

Pressing the and buttons, the machine does not deliver coffee, but only water

- Ground coffee may be blocked in the funnel.
-  Remove the ground coffee inside the funnel, using a knife (see section 6 „Using pre-ground coffee“, page 34, note 5). Then clean the infuser and the inside of the machine (see the description in section 9.3 „Cleaning the infuser“, page 37).

Pressing the button, the machine does not switch on

- The machine is not plugged in.
-  Check that the power cable is plugged into the power outlet.







The infuser cannot be removed for cleaning

- The machine is on. The infuser can only be removed if the machine is off.
-  Turn the machine off (see section 9.3 „Cleaning the infuser“, page 37).



Warning: the infuser can only be removed when the machine is off. Attempting to remove the infuser with the machine on will risk causing damage.

Ground coffee is used (rather than beans) and the machine does not deliver the coffee

- Too much ground coffee has been added.
 -  Remove the infuser and thoroughly clean the inside of the machine, as described in section 9.3 „Cleaning the infuser“, page 37. Repeat the operation using a maximum of 2 level measures of ground coffee.
 - The  button has not been pressed and the machine has used both the ground coffee added and the coffee ground by the grinder.
 -  Thoroughly clean the inside of the machine, as described in section 9.3 „Cleaning the infuser“, page 37. Repeat the operation by first pressing the  button, as indicated in section 6 „Using pre-ground coffee“, page 34.
 - Ground coffee has been added when the machine is off.
 -  Remove the infuser and thoroughly clean the inside of the machine, as described in section 9.3 „Cleaning the infuser“, page 37. Repeat the operation, however switching on the machine first.
- The coffee does not come out of the spouts, but rather around the service door**
- The holes in the spouts are clogged with dry coffee.
 -  Scrape the holes with a needle (Fig. 27).
 - The mobile drawer inside the service door is blocked and cannot swing.
 -  Thoroughly clean the mobile drawer, above all near the hinges, so that they swing smoothly.

What to do if the coffee machine has to be transported

- Keep the original packaging as transport protection. It is important to use the original plastic bag as a protection against scratches.
- Secure the coffee machine against jarring. The manufacturer accepts no liability for damage during transportation.
- Empty the water tank and the container for the coffee grounds.
- Care should also be taken with the location of the coffee machine – especially in cold weather, when damage can be caused by frost.

13 Technical Data

Mains voltage: 220-240 V

Power consumption: 1350 W



This appliance conforms with the following EC Directives:

- Low Voltage Directive 2006/95/EC
- EMC Directive 89/336/EEC with amendments 92/31/EEC and 93/68/EEC

14 Disposal



Packaging material

The packaging materials are environmentally friendly and can be recycled. The plastic components are identified by markings, e.g. >PE<, >PS<, etc. Please dispose of the packaging materials in the appropriate container at the community waste disposal facilities.



Old appliance



The symbol  on the product or on its packaging indicates that this product may not be treated as household waste. Instead it shall be handed over to the applicable collection point for the recycling of electrical and electronic equipment. By ensuring this product is disposed of correctly, you will help prevent potential negative consequences for the environment and human health, which could otherwise be caused by inappropriate waste handling of this product. For more detailed information about recycling of this product, please contact your local city office, your household waste disposal service or the shop where you purchased the product.

15 If service is needed

If repairs should become necessary, including replacement of the mains cable, please telephone **in the first instance our AEG-Electrolux Service Line.**



For Germany : 01801 - 20 30 60*

(*Local tariff on Deutsche Telekom's landline network)
Monday to Friday 8.00 am - 6.00 pm

For Austria:

For Repairs service: 0810-955 400 *

For Product service: 0810-955 200*

*From TELEKOM AUSTRIA's landline network 0.10 Euro/min.

Original packaging, including expanded foam parts, must be retained.

To avoid damage in transport, the appliance must be packed securely.

The warranty period runs for 2 years from the date of purchase. The warranty period is limited to 6 months if the appliance is used commercially. More than 3,000 brewing cycles per year is understood as commercial use.

Electrolux Hausgeräte Vertriebs GmbH
Muggenhofer Str. 135
D-90429 Nürnberg

<http://www.electrolux.de>

© Copyright by Electrolux

822 949 352 – 02 – 0507