



DV704i

INSTALLATION/OWNER'S MANUAL

DVD Multimedia Receiver with 7" Touch Screen Display



Safety Notes:

The DVD video display of the in-dash unit will not operate while the vehicle is moving. This is a safety feature to prevent driver distraction. In-dash DVD video functions will only operate when vehicle is in park and the parking brake is engaged. It is illegal in most states for the driver to view video while the vehicle is in motion.

Copyright Notes

This product incorporates copyright protection technology that is protected by method claims of certain U.S. patents and other intellectual property rights owned by Macrovision Corporation and other rights owners. Use of this copyright protection technology must be authorized by Macrovision Corporation, and is intended for home and other limited viewing uses only unless otherwise authorized by Macrovision Corporation. Reverse engineering or disassembly is prohibited.

Manufactured under license from Dolby Laboratories.

Dolby and the double-D symbol are registered trademarks of Dolby Laboratories.

DVD logo is a trademark of DVD Format/Licensing Corporation registered in the U.S., Japan and other countries.

iPod and iPhone are trademarks of Apple Inc., registered in the U.S. and other countries. Dual Electronics Corporation is not affiliated with Apple, Inc.

SD logo is a trademark of SD-3C, LLC.

Other trademarks and trade names are those of their respective owners.

Table of Contents

	Page
Warning Statement	3
Safety Information/Precautions	4
Preparation/Mounting	5
Wiring Diagram	6
Control Locations	7
Remote Preparation	8
General Operation	9-10
AM/FM Tuner Operation	11-12
CD Operation	13-14
MP3/WMA/JPG Operation	15-21
DVD Operation	22-26
Operation of iPod®	27-28
Auxiliary Inputs/Rear Camera Operation	29
Warranty	30
Specifications	31
Troubleshooting	32



DV704i PREPARATION

WARNING

Upon installation of this Monitor/DVD player ("unit") into a vehicle, the driver of the vehicle must not operate this unit by watching videos or playing video games while driving. Failure to follow this instruction could lead to driver distraction which could result in serious injury or death to the vehicle's occupants or persons outside the vehicle and/or property damage.

Several states prohibit the installation of monitors/DVD players if the screen is visible from the driver's seat. If you reside in a jurisdiction which has enacted such a law, this unit must not be installed so that the screen is visible from the driver's seat. When installing this unit in the front console/dashboard, the unit must be positioned so that it is facing the front passenger seat only. Failure to follow this instruction could lead to driver distraction which could result in serious injury or death to the vehicle's occupants or persons outside the vehicle and/or property damage.

This unit is designed so that it may be operated only when the vehicle is in "Park" and the parking brake is fully engaged. To this end, this unit includes a parking brake lock-out feature which prohibits the unit from operating if the vehicle is not in "Park" and/or the parking brake is not fully engaged. When installing this unit, the installer must connect the parking brake detect wire ("Pink Lead") to the parking brake mechanism in order to make the parking brake lock-out feature operable. DO NOT simply ground the parking brake detect wire to a metal portion of the vehicle. Failure to properly install the parking brake lock-out feature could lead to driver distraction which could result in serious injury or death to the driver's occupants or persons outside the vehicle and/or property damage.

Once the parking brake lock-out feature is installed, the owner/user must not attempt to disrupt/neutralize the parking brake lock-out feature by (a) partially engaging the parking brake and/or (b) purchasing/using any device or unit designed to send necessary brake signals to the unit. Failure to follow these instructions could lead to driver distraction which could result in serious injury or death to the driver's occupants or persons outside the vehicle and/or property damage.

When operating this unit, keep the unit's volume level low enough so that the vehicle's occupants can hear traffic-related sounds such as police and emergency vehicles. Failure to follow this instruction could lead to driver distraction which could result in serious injury or death to the vehicle's occupants or persons outside the vehicle and/or property damage.

Safety Information

Please read all instructions carefully before attempting to install or operate.

Due to its technical nature, it is highly recommended that your DUAL DV704i is installed by a professional installer or an authorized dealer. This product is only for use in vehicles with 12VDC negative ground only.

To prevent damage or injury:

- Make sure to ground the unit securely to the vehicle chassis ground.
- Do not remove the top or bottom covers of the unit.
- Do not install the unit in a spot exposed to direct sunlight or excessive heat or the possibility of water splashing.
- Do not subject the unit to excessive shock.
- When replacing a fuse, only use a new one with the prescribed rating. Using a fuse with the wrong rating may cause the unit to malfunction.
- To prevent short circuits when replacing a fuse, disconnect the wiring harness first.
- Use only the provided hardware and wire harness.
- You cannot view video while the vehicle is moving. Find a safe place to park and engage the parking brake.
- If you experience problems during installation, consult your nearest DUAL dealer.
- If the unit malfunctions, reset the unit as described on page 9 first. If the problem still persists, consult your nearest DUAL dealer or call tech assistance @ 1-866-382-5476.
- To clean the monitor, wipe only with a dry silicone cloth or soft cloth. Do not use a stiff cloth, or volatile solvents such as paint thinner and alcohol. They can scratch the surface of the panel and/or remove the printing.
- When the temperature of the unit falls (as in winter), the liquid crystal inside the screen will become darker than usual. Normal brightness will return after using the monitor for a while.
- When extending the ignition, battery or ground cables, make sure to use automotive-grade cables or other cables with an area of 0.75mm (AWG 18) or more to prevent voltage drops.
- Do not touch the liquid crystal fluid if the LCD is damaged or broken. The liquid crystal fluid may be hazardous to your health or fatal. If the liquid crystal fluid from the LCD contacts your body or clothing, wash it off with soap immediately.

FCC Compliance

This device complies with Part 15 of the FCC Rules. Operation is subject to the following two conditions:

- (1) this device may not cause harmful interference, and
- (2) this device must accept any interference received, including interference that may cause undesired operation.

Warning: Changes or modifications to this unit not expressly approved by the party responsible for compliance could void the user's authority to operate the equipment.

Note: This equipment has been tested and found to comply with the limits for a Class B digital device, pursuant to Part 15 of the FCC Rules. These limits are designed to provide reasonable protection against harmful interference in a residential installation. This equipment generates, uses and can radiate radio frequency energy and, if not installed and used in accordance with the instructions, may cause harmful interference to radio communications. However, there is no guarantee that interference will not occur in a particular installation. If this equipment does cause harmful interference to radio or television reception, which can be determined by turning the equipment off and on, the user is encouraged to try to correct the interference by one or more of the following measures:

- Reorient or relocate the receiving antenna.
- Increase the separation between the equipment and receiver.
- Connect the equipment into an outlet on a circuit different from that to which the receiver is connected.
- Consult the dealer or an experienced radio/TV technician for help.



DV704i INSTALLATION

Preparation

Before You Start

- Disconnect negative battery terminal. Consult a qualified technician for instructions.
- Avoid installing the unit where it would be subject to high temperatures, such as from direct sunlight, or where it would be subject to dust, dirt or excessive vibration.

Getting Started

- Insert the supplied keys into the slots as shown, and slide the unit out of the mounting sleeve.
- Install mounting sleeve into opening, bending tabs to secure.
- Connect wiring harness as shown on page 6. Consult a qualified technician if you are unsure.
- Certain vehicles may require an installation kit and/or wiring harness adapter (sold separately).
- Reconnect negative battery terminal, and test for correct operation.
- Snap trim ring into place (if required).
- Slide unit into mounting sleeve to secure.

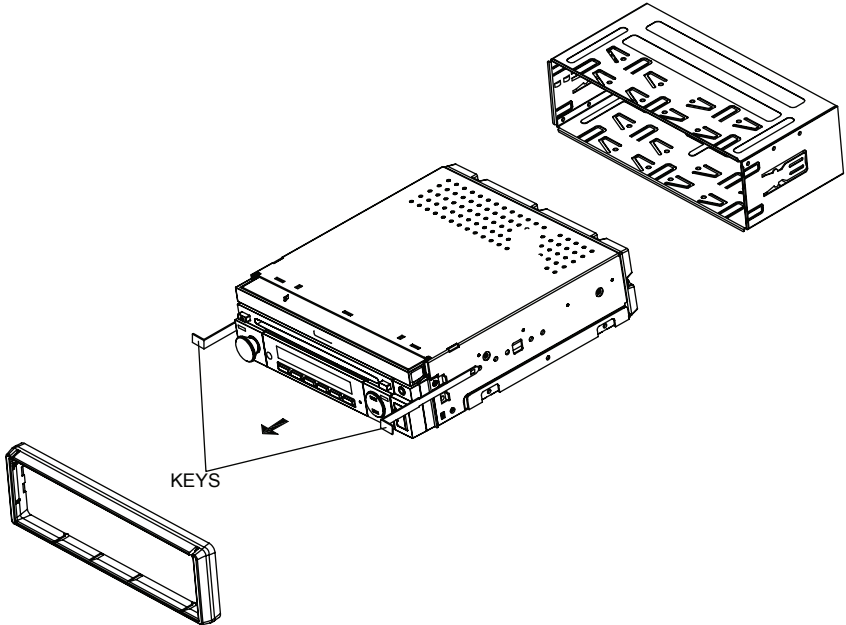
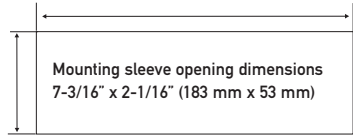

TYPICAL FRONT-LOAD DIN MOUNTING METHOD

Wiring Diagram - Inputs/Outputs

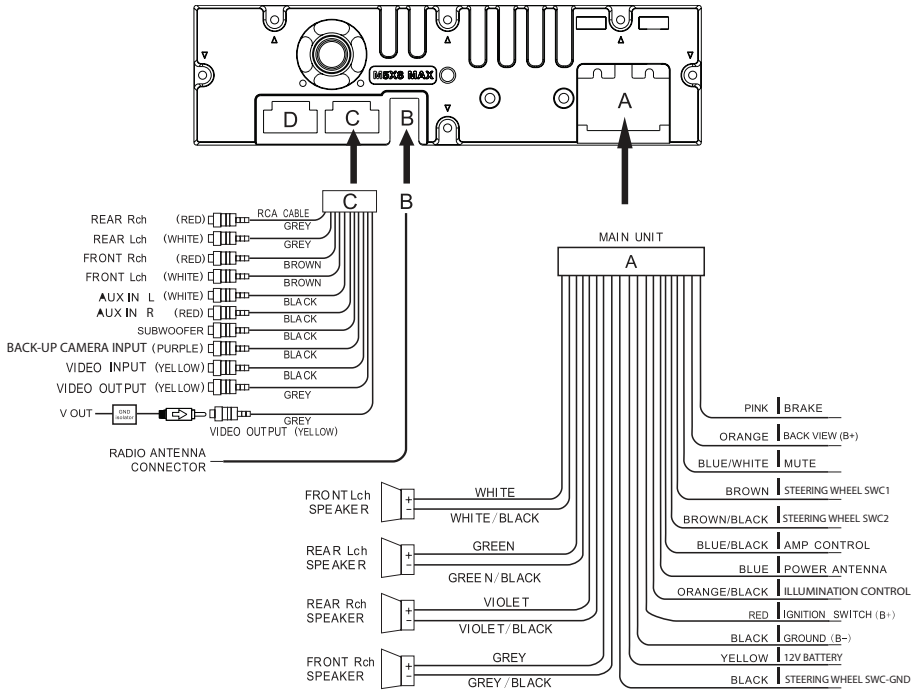

Wiring Notes:

Subwoofer output

The Subwoofer preamp audio output (black jacket with green RCA) is active in all audio modes.

Rear camera input

A rear view camera (not included) can be used with the Camera input. Refer to page 27 for details.

Connecting an iPod/iPhone device

To play music from an iPod/iPhone device, connect the original iPod connection cable to the DV704i. Once connected, playback will begin automatically.

Note:

When replacing a fuse, make sure to use the correct type and amperage. Using an incorrect fuse could damage the unit. The DV704i uses (1) 15 amp ATC mini style fuse located on the back of the unit.

Control Locations

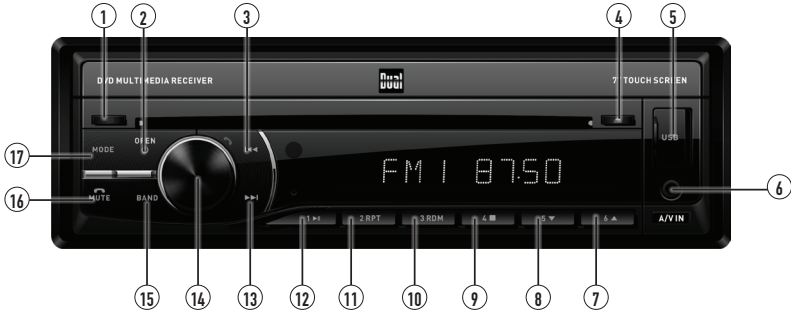

- | | |
|------------------------------|---------------------------|
| ① Release | ⑨ Preset 4 / Stop |
| ② Power / Open | ⑩ Preset 3 / Random |
| ③ Tune / Track Down | ⑪ Preset 2 / Repeat |
| ④ Eject | ⑫ Preset 1 / Play / Pause |
| ⑤ USB Port | ⑬ Tune / Track Up |
| ⑥ Auxiliary A/V Input | ⑭ Volume Up/Down |
| ⑦ Preset 6 / Tune/Track Up | ⑮ Band |
| ⑧ Preset 5 / Tune/Track Down | ⑯ Mute |
| | ⑰ Mode |

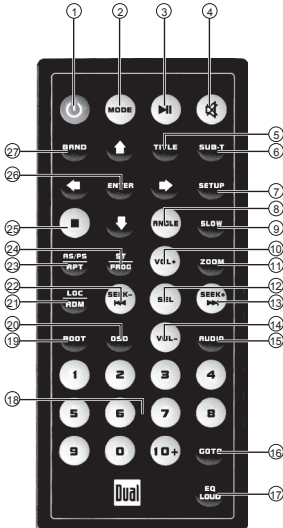

- | | |
|--------------------------|----------------------------|
| ① Power | ⑮ Audio |
| ② Mode | ⑯ GOTO |
| ③ Play / Pause | ⑰ EQ / Loudness |
| ④ Mute | ⑱ Number Keys |
| ⑤ Title | ⑲ ROOT |
| ⑥ Subtitle | ⑳ OSD |
| ⑦ Setup | ㉑ Local / Random |
| ⑧ Angle | ㉒ Seek / Tune / Track Down |
| ⑨ Slow | ㉓ AS/PS / Repeat |
| ⑩ Volume Up | ㉔ ST / Program |
| ⑪ Zoom | ㉕ Stop |
| ⑫ Select | ㉖ Enter |
| ⑬ Seek / Tune / Track Up | ㉗ Band |
| ⑭ Volume Down | |

Remote Control Preparation

Remove battery insulation tape

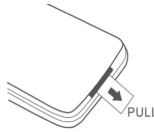

To insert or replace the battery, remove the battery holder.

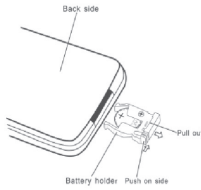

Remove the battery from the battery holder.

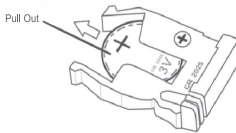

Install the new battery.
Make sure to keep the (+) side up.

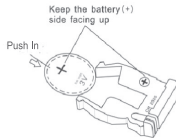

Insert the battery holder .

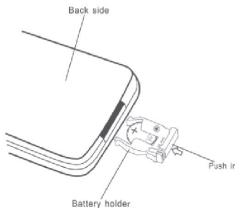



Notes:

- The remote control uses one 3 volt Lithium CR2025 battery. Remove the battery if the remote will not be used for a month or longer.
- Remove and dispose of battery properly.
- Do not store battery with metallic objects or materials.



General Operation

Power / Open	Momentarily press  to turn the unit on. Press and hold  for 2 seconds to turn the unit off. When the unit is on, pressing  will open or close the monitor.
Volume	Rotate the volume knob to increase or decrease the volume level (0-39).
Volume Memory	If the volume level is <21 when the unit is turned off, it will be retained in memory the next time the unit is turned on. If the volume level is >20 when the unit is turned off, the volume level will automatically default to 20 the next time the unit is turned on.
Mute	Momentarily press MUTE to silence the audio. Momentarily press MUTE again to return to the previously selected volume. Rotating the volume knob while the volume is muted will also cancel the mute function.
Mode	Press MODE to step through all available input modes: Tuner, Disc (which includes DVD and CD playback), iPod, SD, USB, AV1 and AV2. Modes of operation are indicated on the display and/or the monitor. Optional iPod device, USB flash drive and SD card must be connected/inserted to appear in the mode selection string.
Reset	To resolve abnormal operation or if the unit is inoperable, use the tip of a pen to press the RESET button. The unit will reset the main processor to the default settings.
3.5mm A/V Input	Connect external audio/video devices to the 3.5mm auxiliary A/V input on the front panel.
USB Port	Connect a USB device to play MP3/WMA files or view JPG photos. The DV704i's USB port supports USB, iPod and iPhone playback.
Main Menu	When the monitor is open, press the arrow in the top right corner to access the Main Menu screen.

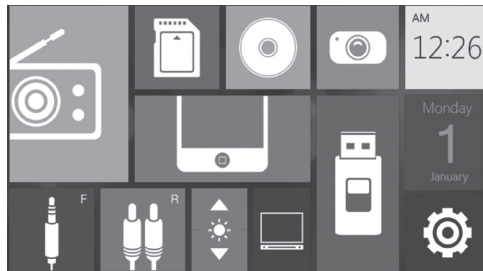

From the Main Menu screen:

- View/select any operational mode by touching the corresponding icon.
- Use the up and down arrows to adjust the angle of the screen
- Select **SETUP** to enter the Setup menu.

General Operation

Setup Menu

From the Main Menu screen, press **SETUP** in the bottom left corner to access the Setup menu. Select one of the seven icons across the top (General, Time, Language, Audio, Video, Tuner and Calibration) to access the sub-menu for that category. Use the up and down arrow keys on the right to scroll up and down through the available sub-menu options.

General

- **Beep** - Select **Off** or **On** to disable or enable the audible beep.
- **Camera** - Select a **Normal** or **Mirror** image for camera input.

Time

- **Time** - Press the current time to edit, then use the up and down arrows to change the hour and minute settings.
- **Year** - Press the current year to edit, then use the up and down arrows to increase or decrease the value.
- **Month** - Press the current month to edit, then use the up and down arrows to increase or decrease the value.
- **Day** - Press the current day to edit, then use the up and down arrows to increase or decrease the value.

Language

- **Language** - Select desired language (this option is available only on certain models).

Audio

- **Subwoofer** - Turn the Subwoofer output **On** or **Off**.
- **Loudness** - Turn the Loudness function **On** or **Off**.
- **EQ** - Select from EQ options: **Pop**, **Rock**, **Classic**, **Jazz** or **Off**.

Video

- **Aspect Ratio** - Select one of the following ratios: **4:3LB**, **4:3PS** or **16:9**.
- **Brightness** - Adjust the brightness level from 0-14 (default is 7).
- **Contrast** - Adjust the contrast level from 0-14 (default is 7).
- **Saturation** - Adjust the saturation level from 0-14 (default is 7).
- **Hue** - Adjust the hue from 0-14 (default is 7).
- **Standard Video** - Press "Yes" to reset video adjustments to default values.

Tuner

- **Radio Region** - Set the unit for one of the following regions: **Europe**, **America 1**, **America 2**, **Japan** or **Russia**.

Calibration

- **Calibration** - Press **SELECT** to begin calibration of the touch screen. Press the center of the + as indicated on the screen to calibrate the touchscreen.

AM/FM Tuner Operation



Tuner Operation

Select the Tuner icon from the Main Menu screen or press **MODE** until Tuner is selected. The following instructions outline tuner operation using the touch screen monitor; however, the tuner can also be controlled using the buttons on the face of the radio when the monitor is closed.

Current Mode Indicator (1)

Displays current mode of operation.

Information Display (2)

Displays information such as Loudness and EQ settings.

Tune Frequency Up (3)

Press momentarily to manually tune to a higher frequency. Press and hold to seek tune to the next strong station.

Tune Frequency Down (4)

Press momentarily to manually tune to a lower frequency. Press and hold to seek tune to the previous strong station.

Mute (5)

Press to turn the Mute feature on or off.

Setup (6)

Press to access Audio and Video setup menus.

Audio Setup

- Volume - Adjust volume level from 0-39.
- Bass - Adjust bass level from -7 to 7.
- Treble - Adjust treble level from -7 to 7.
- Balance - Adjust balance from Left (L07) to Right (R07); "00" represents equal balance.
- Fader - Adjust fader from Front (F07) to Rear (R07); "00" represents equal fader.

AM/FM Tuner Operation

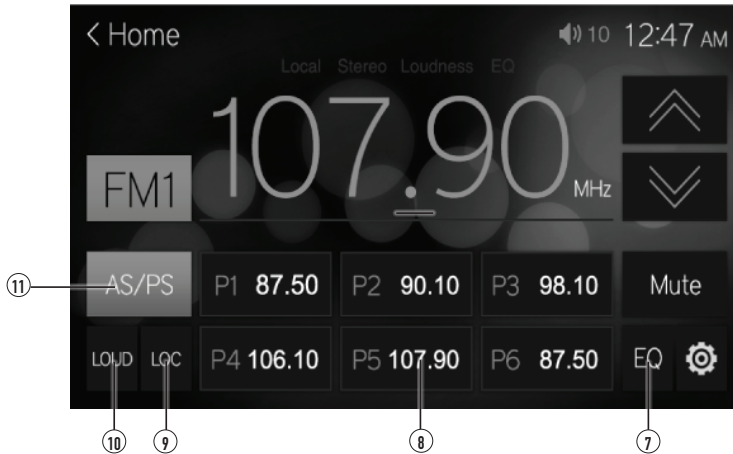

Video Setup

- Brightness - Adjust brightness level from 0-14 (7 is the default).
- Contrast - Adjust contrast level from 0-14 (7 is the default).
- Saturation - Adjust saturation level from 0-14 (7 is the default).
- Hue - Adjust hue from 0-14 (7 is the default).

EQ 7

Press EQ to step through the following EQ options: **Pop**, **Rock**, **Classic**, **Jazz** or **Off**.

Preset Station Display 8

Displays the six preset stations stored in memory in the current band. Press any preset station to play it instantly. Up to 18 FM and 12 AM stations can be stored in memory.

Local 9

Press LOC to select between Local (**LOC ON**) and Distance (**LOC OFF**) tuning options. The local option tunes to nearby radio stations with sufficiently strong signals for good reception. In areas where reception is poor, switching to distance tuning enables the unit to tune in to more distant stations. Distance tuning is the default tuning mode.

Loudness 10

Press LOUD to turn the Loudness feature **On** or **Off**.

AS/PS 11

Press and hold AS/PS to automatically find and store the strongest stations as presets. Press AS/PS momentarily to scan preset stations and play 10 seconds of each.

CD Operation



CD Operation

Insert disc into the slot with the label facing up at a slight upward angle, and playback will begin automatically. If a disc has previously been inserted and the unit has been operating in another mode, resume disc playback by selecting the DISC icon from the Main Menu screen or pressing **MODE** until DISC is selected.

The following instructions outline tuner operation using the touch screen monitor; however, the tuner can also be controlled using the buttons on the face of the radio when the monitor is closed.

Current Mode Indicator (1)

Displays current mode of operation.

Elapsed Time Indicator (2)

Displays the elapsed time of the current track.

Track Indicator (3)

Displays the current and total number of tracks on the disc.

Scroll Up / Down Arrows (4)

Press to scroll up or down the pages in the track playlist.

Volume Indicator (5)

Displays the current volume setting of the unit.

CD Track List (6)

Displays the first five tracks on the CD. Use the arrow keys to scroll down and up through the entire list, or press a track number to play it instantly. Elapsed time of current track will be displayed when playback begins.

Main Menu Access (7)

Press to return to Main Menu screen.

Play / Pause (8)

Press to pause CD. Press again to resume CD playback.

Stop (9)

Press ■ to temporarily stop playback. Press play to resume playback from the current position. Press ■ a second time to fully stop playback. Press play to begin playback from the beginning of the disc.

CD Operation

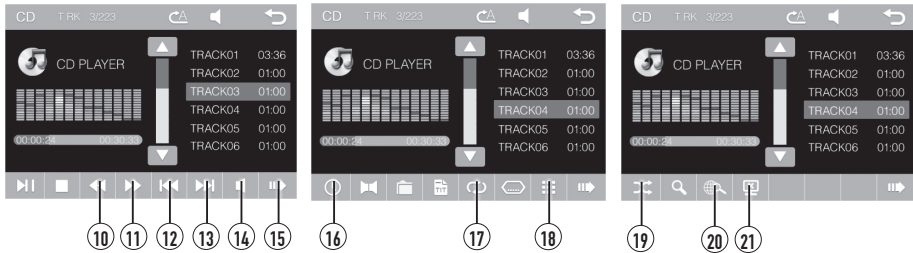

Fast Reverse ⑩

Press ◀◀ to fast reverse CD playback. Each touch changes speed from 2x to 4x to 8x to 16x to 20x then back to regular playback.

Fast Forward ⑪

Press ▶▶ to fast forward CD playback. Each touch changes speed from 2x to 4x to 8x to 16x to 20x then back to regular playback.

Previous Track ⑫

Press to go back to the previous track.

Next Track ⑬

Press to advance to the next track.

Volume / Audio Settings ⑭

Press to display and adjust the current volume level from 0 to 39. Touch VOL to step through the following audio settings:

- Bass - Adjust bass level from -7 to 7.
- Treble - Adjust treble level from -7 to 7.
- Balance - Adjust balance from Left (L07) to Right (R07); "00" represents equal balance.
- Fader - Adjust fader from Front (F07) to Rear (R07); "00" represents equal fader.

Additional Options ⑮

Press to access additional CD playback options.

Time Indicator ⑯

Press to toggle from displaying the elapsed time to displaying the remaining time of the current track.

Repeat ⑰

Press to step through the Repeat options: **RPT ONE** (repeats current song), **RPT ALL** (repeats all songs on disc) and **OFF**.

Direct Track Access ⑱

Press to access numeric keyboard to select desired track number. Input track number, press **OK** and playback of selected track will begin.

Random ⑲

Press to turn Random play **ON** or **OFF**.

Intro ⑳

Press to play the first 10 seconds of each song on the disc. Press again to return to sequential play.

TFT Screen ㉑

Press to turn off the TFT display. Press anywhere on the touch screen to turn the display back on.

MP3/WMA/JPG Operation

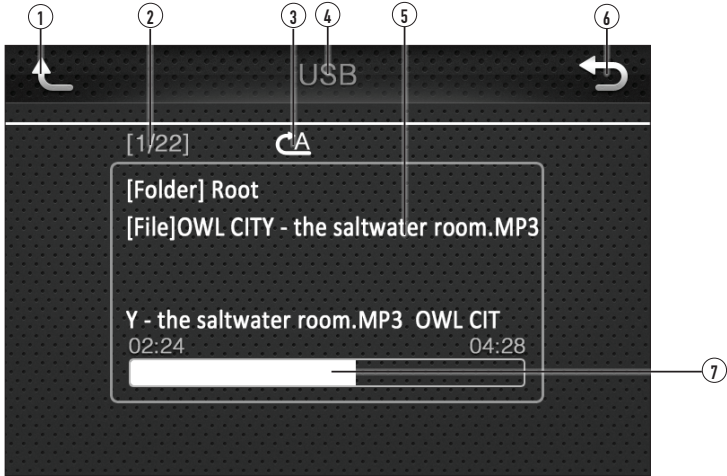

MP3/WMA/JPG Playback from Disc, USB Device or SD Card

To play MP3, WMA and JPG files from a disc, USB device or micro SD card. Insert disc, connect USB device or insert SD card, and playback will begin automatically. To return to disc, USB or SD card playback from another mode of operation, select the DISC, USB or SD icon from the Main Menu screen or top icon display, or press **MODE** until DISC, USB or SD is selected.

- **Using a Cable** - Connect a USB device to the front USB port.
- **Using an SD Card** - Insert SD card with the label facing up into the SD slot located behind the face of the unit.

Note: It is not possible to view JPG files on the in-dash monitor while the vehicle is moving. This is a safety feature to prevent driver distraction. The JPG image viewer function will only operate when vehicle is in Park and the parking brake is engaged as described on page 22.

- | | |
|--|--|
| <p>Navigation Button ①</p> <p>File Indicator ②</p> <p>OSD Controls ③</p> <p>Current Mode Indicator ④</p> <p>Information Display ⑤</p> <p>Main Menu Access ⑥</p> <p>Elapsed Time ⑦</p> | <p>Each press of this button navigates up through the following menus and folders: Folder Menu (list of all songs in folder), Device Menu (list of all folders) and Playback Menu (select between Music or JPG).</p> <p>Indicates current file and the total number of files in the current folder.</p> <p>Press to view the OSD controls.</p> <p>Displays current mode of operation.</p> <p>Scrolls through available file information, including file name, song title, artist name and album name.</p> <p>Press to return to Main Menu screen.</p> <p>Displays the elapsed time of the current track.</p> |
|--|--|

MP3/WMA/JPG Operation

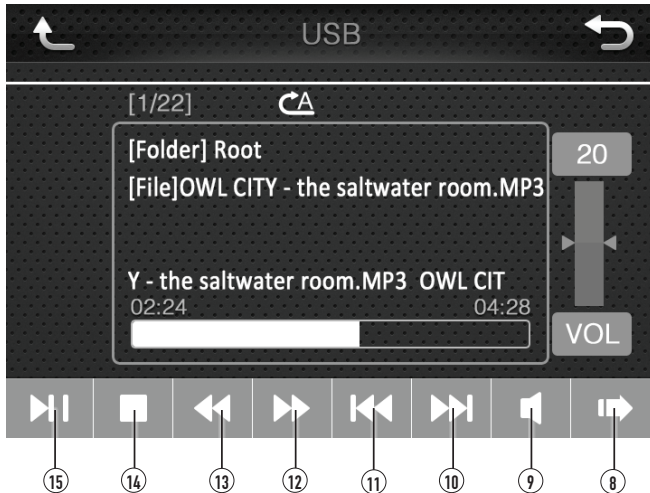

- | | |
|----------------------------------|---|
| Additional Options ⑧ | Press to access additional playback options. |
| Volume / Audio Settings ⑨ | <p>Press to display and adjust the current volume level from 0 to 39. Touch VOL to step through the following audio settings:</p> <ul style="list-style-type: none"> • Bass - Adjust bass level from -7 to 7. • Treble - Adjust treble level from -7 to 7. • Balance - Adjust balance from Left (L07) to Right (R07); "00" represents equal balance. • Fader - Adjust fader from Front (F07) to Rear (R07); "00" represents equal fader. |
| Next Track ⑩ | Press to advance to the next file. |
| Previous Track ⑪ | Press to go back to the previous file. |
| Fast Forward ⑫ | Press ►► to fast forward file playback. Each touch changes speed from 2x to 4x to 8x to 16x to 20x then back to regular playback. |
| Fast Reverse ⑬ | Press ◀◀ to fast reverse file playback. Each touch changes speed from 2x to 4x to 8x to 16x to 20x then back to regular playback. |
| Stop ⑭ | Press ■ to temporarily stop playback and return to the current folder menu. |
| Play / Pause ⑮ | Press to pause playback. Press again to resume playback. |

MP3/WMA/JPG Operation



Additional Options (16) Press to return to original OSD option display.

Direct Song Access (17) Press to access numeric keyboard to select desired song number. Input song number, press **OK** and playback of selected song will begin.

TFT Screen (18) Press to turn off the TFT display. Press anywhere on the touch screen to turn the display back on.

Repeat (19) Press to step through the Repeat options: **RPT ONE** (repeats current song), **RPT Folder** (repeats all songs in current folder), **RPT ALL** (repeats all songs on device) and **OFF**.

Random (20) Press to turn the Random function ON or OFF.

MP3/WMA/JPG Operation

Viewing JPEG Images

When viewing JPG images, press **Area E** to display on-screen JPG controls.

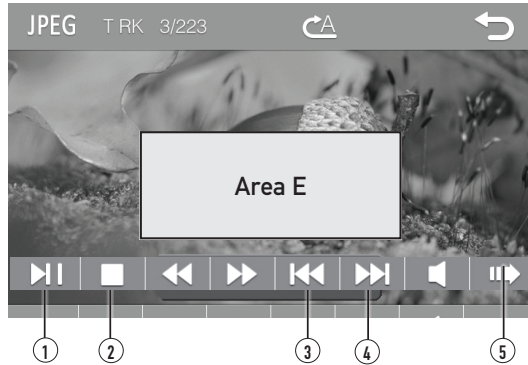

Play / Pause ①

Press to pause slideshow at current image. Press again to resume.

Stop ②

Press to stop slideshow and return to photo menu.

Previous Photo ③

Press to go back to the previous image.

Next Photo ④

Press to advance to the next image.

Additional Options ⑤

Press to access additional photo options.



Repeat ⑥

Press to step through the Repeat options: **RPT ONE** (repeats current image), **RPT FOLDER** (repeats all images in the current folder), **RPT ALL** (repeats all images on the disc or device) and **OFF**.

Direct File Access ⑦

Press to access numeric keyboard. Input file number, press **OK** and playback of selected file in the current folder will begin.

Zoom ⑧

Press to zoom in (2x, 3x, 4x) or out (1/2x, 1/3x, 1/4x) on the selected image or turn the zoom feature off.

TFT Display ⑨

Press to turn off the TFT display. Press anywhere on the touch screen to turn the display back on.



Media Compatibility - USB/SD Card

File Type		WMA	MP3		
File System	FAT	FAT 12	X	X	
		FAT 16/FAT 32	✓	✓	
File Extension	.mp3/.MP3/.Mp3/.mP3		X	✓	
	.wma/.WMA		✓	X	
	.rmp/.m4a		X	X	
MPEG Format	MPEG 1		X	✓	
	MPEG 2		X	✓	
	MPEG 2.5		X	✓	
Sampling Frequency	MPEG 1		X	32/44.1/48kHz	
	MPEG 2		X	12/16/22.05/24kHz	
	MPEG 2.5		X	8/11.025/12kHz	
Bitrate	WMA		32/44.1/48kHz	X	
	MPEG 1		X	32 ~ 320kbps	
	MPEG 2		X	8 ~ 160kbps	
	MPEG 2.5		X	8 ~ 160kbps	
Other Information	WMA		32 ~ 192kbps	X	
	Directory Depth		Unlimited	Unlimited	
	File Name Length		32 bytes	32 bytes	
	Total File Number		2000 files	2000 files	
	Total Folder Number		200 folders	200 folders	
	File Number via Folder		2000 files	2000 files	
	MP3 ID3 TAG	ver.1.x		X	✓
		ver.2.x		X	✓
Title, Artist, Album		X	✓		
WMA TAG	Title, Artist		✓	X	

Notes:

- Due to ongoing technological advancement, some USB flash drives and/or SD cards may be incompatible with this unit.

Media Compatibility - CD/DVD

File Type				WMA	MP3
File System	ISO9660	Level 1, Level 2		✓	✓
		Level 3		X	X
	ISO9660 Extension	JOLIET	Playback	✓	✓
			Filename	32 bytes	32 bytes
	Other Extensions	ROMEO	Playback	X	X
			Filename	X	X
Apple ISO		X	X		
File Extension	.mp3/.MP3/.Mp3/.mP3			X	✓
	.wma/.WMA			✓	X
	.rmp/.m4a			X	X
MPEG Format	MPEG 1			X	✓
	MPEG 2			X	✓
	MPEG 2.5			X	✓
Sampling Frequency	MPEG 1			X	32/44.1/48kHz
	MPEG 2			X	12/16/22.05/24kHz
	MPEG 2.5			X	8/11.025/12kHz
	WMA			32/44.1/48kHz	X
Bitrate	MPEG 1			X	32 ~ 320kbps
	MPEG 2			X	8 ~ 160kbps
	MPEG 2.5			X	8 ~ 160kbps
	WMA			32 ~ 192kbps	X
Other Information	Directory Depth			Unlimited	Unlimited
	File Name Length			32 bytes	32 bytes
	Total File Number			2000 files	2000 files
	Total Folder Number			200 folders	200 folders
	File Number via Folder			2000 files	2000 files
	MP3 ID3 TAG	ver.1.x		X	✓
		ver.2.x		X	✓
		Title, Artist, Album		X	✓
WMA TAG	Title, Artist		✓	X	



Media Compatibility

Media Compatibility	<p>The following types of discs are compatible:</p> <ul style="list-style-type: none">• CD-DA, CD-ROM (ISO), CD-R, CD-RW• DVD Video, DVD+R/RW, DVD-R/RW <p>The following types of discs/files are not compatible:</p> <ul style="list-style-type: none">• WMA files that are protected by DRM (Digital Rights Management)• WMA lossless format• Discs recorded with Track At Once or packet writing• MP3 PRO format, MP3 playlists• RMP format• WAV format• WMV format• DivX, Xvid format• AVI format• MPG format• AAC, protected AAC, M4A format <p>Some recordable DVD's and CD's may be incompatible with this unit, depending on media type and recording method.</p>
Playback Order	<p>MP3/WMA playback sequence begins in the root folder of the disc, USB flash drive or SD card. Any empty folders or folders that do not include MP3/WMA/JPG files are skipped.</p>
Compatible Recording Formats	<p>ISO9660 standards:</p> <ul style="list-style-type: none">• Maximum nested folder depth is 8 (including the root folder).• Valid characters for folder/file names are letters A-Z (all caps), numbers 0-9, and “_” (underscore). Some characters may not be displayed correctly, depending on the character type.• This device can play back discs in Joliet and other standards that conform to ISO9660. MP3/WMA written in the formats other than the above may not play and/or their file names or folder names may not be displayed properly.
Additional MP3/WMA Information	<p>An internal buffer provides ESP (Electronic Skip Protection) to virtually eliminate skipping.</p> <p>When playing a disc recorded with regular audio files (CD-DA or .WAV) and MP3/WMA files, the unit will play the MP3/WMA files only.</p>
Notes	<p>Some files may not play or be displayed correctly, depending on sampling rates and bit rates.</p> <p>For best results, use the following settings when ripping MP3 files: 128kbps or higher constant bit rate 44.1kHz or higher sampling frequency</p> <p>For best results, use the following settings when ripping WMA files: 64kbps or higher constant bit rate 44.1kHz or higher sampling frequency</p>

WARNING

Upon installation of this Monitor/DVD player (“unit”) into a vehicle, the driver of the vehicle must not operate this unit by watching videos or playing video games while driving. Failure to follow this instruction could lead to driver distraction which could result in serious injury or death to the vehicle’s occupants or persons outside the vehicle and/or property damage.

Several states prohibit the installation of monitors/DVD players if the screen is visible from the driver’s seat. If you reside in a jurisdiction which has enacted such a law, this unit must not be installed so that the screen is visible from the driver’s seat. When installing this unit in the front console/dashboard, the unit must be positioned so that it is facing the front passenger seat only. Failure to follow this instruction could lead to driver distraction which could result in serious injury or death to the vehicle’s occupants or persons outside the vehicle and/or property damage.

This unit is designed so that it may be operated only when the vehicle is in “Park” and the parking brake is fully engaged. To this end, this unit includes a parking brake lock-out feature which prohibits the unit from operating if the vehicle is not in “Park” and/or the parking brake is not fully engaged. When installing this unit, the installer must connect the parking brake detect wire (“Pink Lead”) to the parking brake mechanism in order to make the parking brake lock-out feature operable. DO NOT simply ground the parking brake detect wire to a metal portion of the vehicle. Failure to properly install the parking brake lock-out feature could lead to driver distraction which could result in serious injury or death to the driver’s occupants or persons outside the vehicle and/or property damage.

Once the parking brake lock-out feature is installed, the owner/user must not attempt to disrupt/neutralize the parking brake lock-out feature by (a) partially engaging the parking brake and/or (b) purchasing/using any device or unit designed to send necessary brake signals to the unit. Failure to follow these instructions could lead to driver distraction which could result in serious injury or death to the driver’s occupants or persons outside the vehicle and/or property damage.

When operating this unit, keep the unit’s volume level low enough so that the vehicle’s occupants can hear traffic-related sounds such as police and emergency vehicles. Failure to follow this instruction could lead to driver distraction which could result in serious injury or death to the vehicle’s occupants or persons outside the vehicle and/or property damage.

DVD Operation

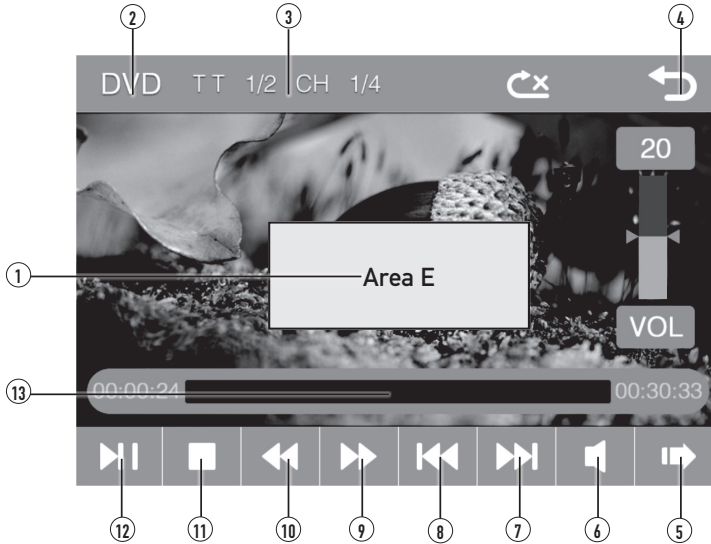

Inserting a Disc

Insert disc into the slot at a slight upward angle and playback will begin automatically. Sub-menus may have to be pressed to access the DVD content. Read the directions of your specific DVD disc for other features.

Ejecting the Disc

Press to eject the disc.

Touchscreen Controls ①

During DVD playback, press **Area E** to display on-screen DVD controls.

Current Mode Indicator ②

Displays current mode of operation.

Current Chapter Indicator ③

Indicates the current chapter and total number of chapters on the DVD. Press to access numeric keyboard to select desired chapter number. Input chapter number, press **OK** and playback of selected chapter will begin.

Main Menu Access ④

Press to return to main menu screen.

Additional Options ⑤

Press to access additional DVD options.

Volume / Audio Settings ⑥

Press to display and adjust the current volume level from 0 to 39. Touch **VOL** to step through the following audio settings:

- Bass - Adjust bass level from -7 to 7.
- Treble - Adjust treble level from -7 to 7.
- Balance - Adjust balance from Left (L07) to Right (R07); "00" represents equal balance.
- Fader - Adjust fader from Front (F07) to Rear (R07); "00" represents equal fader.

DVD Operation

- Next Chapter** (7) Press to advance to the next chapter.
- Previous Chapter** (8) Press to go back to the previous chapter.
- Fast Forward** (9) Press ►► to fast forward DVD playback. Each touch changes speed from 2x to 4x to 8x to 16x to 20x then back to regular playback.
- Fast Reverse** (10) Press ◀◀ to fast reverse DVD playback. Each touch changes speed from 2x to 4x to 8x to 16x to 20x then back to regular playback.
- Stop** (11) Press ■ to temporarily stop playback. Press play to resume playback from the current position. Press ■ a second time to fully stop playback. Press play to begin playback from the beginning of the DVD.
- Play / Pause** (12) Press to pause playback. Press again to resume playback.
- Elapsed Time Indicator** (13) Shows the elapsed time of DVD playback.

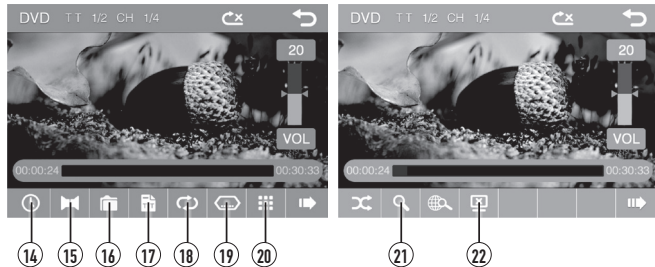

- Remaining Time** (14) Press to view the remaining time rather than the elapsed time (default).
- Language Options** (15) Press to select different language options (if available).
- Previous Folder** (16) Press to return to the previous folder on the DVD (if available).
- Title Menu** (17) Press to return to the title menu of the DVD.
- Repeat** (18) Press to step through the Repeat options: CHAPTER, TITLE, RPT ALL and OFF.
- Subtitle Language** (19) Press to select desired subtitle language (if available): English, Spanish, French or Off.
- Direct Chapter Access** (20) Press to access numeric keyboard to select desired chapter number. Input chapter number, press OK and playback of selected chapter will begin.
- Zoom** (21) Press to zoom in (2x, 3x, 4x) or out (1/2x, 1/3x, 1/4x) during DVD playback or turn the zoom feature off.
- TFT Screen** (22) Press to turn off the TFT display. Press anywhere on the touch screen to turn the display back on.

Operation of iPod

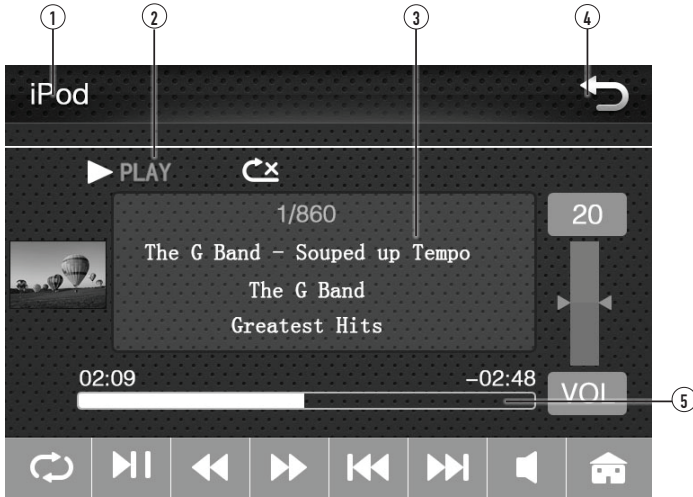

Operation of iPod

Connect an iPod device using the original iPod cable to listen to music.

Playback can be controlled by either the DV704i's on-screen controls or directly from the iPod.

This model does not support video/photo playback.

Current Mode Indicator ①

Displays current mode of operation.

Playback Information ②

Displays information about current playback functions.

Song Information ③

Displays information about the current song, including name, artist and album (if information is available).

Main Menu ④

Press to access main menu screen. During iPod playback, this button also serves as a return arrow to go up one level when navigating the music menu.

Elapsed Time Indicator ⑤

Displays both the elapsed and remaining time for playback of the current song.

Operation of iPod

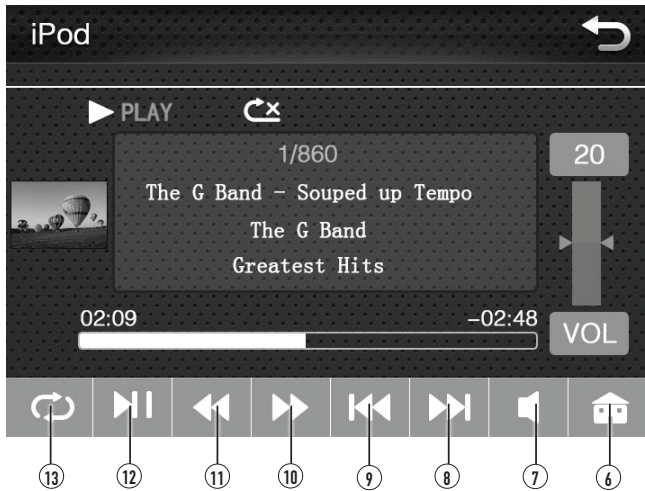

Menu ⑥ Press to return to the main menu.

Volume / Audio Settings ⑦ Press to display and adjust the current volume level from 0 to 39. Touch VOL to step through the following audio settings:

- Bass - Adjust bass level from -7 to 7.
- Treble - Adjust treble level from -7 to 7.
- Balance - Adjust balance from Left (L07) to Right (R07); "00" represents equal balance.
- Fader - Adjust fader from Front (F07) to Rear (R07); "00" represents equal fader.

Next Track ⑧ Press to advance to the next song.

Previous Track ⑨ Press to go back to the previous song.

Fast Forward ⑩ Press ►► to fast forward file playback.

Fast Reverse ⑪ Press ◀◀ to fast reverse file playback.

Play / Pause ⑫ Press to pause playback. Press again to resume playback.

Repeat ⑬ Press to step through the Repeat options: **RPT ONE** (repeats current song), **RPT Folder** (repeats all songs in current folder), **RPT ALL** (repeats all songs on device) and **OFF**.



Auxiliary Inputs - AV1 & AV2

Using AV1 Input	<p>Connect an optional audio/video source into the 3.5mm (front panel) input.</p> <p>Select AV1 from the Main Menu to listen to audio.</p> <p>Adjust volume on the external audio source as needed (if connected to the headphone output of the device).</p>
Using AV2 Input	<p>Connect an optional audio/video source to the Auxiliary Input 2 (Red/White/Yellow RCA connectors). Refer to page 6 for details.</p> <p>Select AV2 from the Main Menu to listen to audio.</p>

Rear Camera Operation - (Optional)

Using Rear Camera	<p>Connect an optional rear camera to the Camera Input (purple RCA connector). Refer to page 6 for details.</p> <p>The unit will automatically select camera mode when connected to the reverse lamp circuitry. Refer to page 6 for details.</p>
--------------------------	--

Limited One Year Warranty

This warranty gives you specific legal rights. You may also have other rights which vary from state to state.

Dual Electronics Corp. warrants this product to the original purchaser to be free from defects in material and workmanship for a period of one year from the date of the original purchase.

Dual Electronics Corp. agrees, at our option, during the warranty period, to repair any defect in material or workmanship or to furnish an equal new, renewed or comparable product (whichever is deemed necessary) in exchange without charges, subject to verification of the defect or malfunction and proof of the date of purchase. Subsequent replacement products are warranted for the balance of the original warranty period.

Who is covered? This warranty is extended to the original retail purchaser for products purchased from an authorized Dual dealer and used in the U.S.A.

What is covered? This warranty covers all defects in material and workmanship in this product. The following are not covered: software, installation/removal costs, damage resulting from accident, misuse, abuse, neglect, product modification, improper installation, incorrect line voltage, unauthorized repair or failure to follow instructions supplied with the product, or damage occurring during return shipment of the product. Specific license conditions and copyright notices for the software can be found via www.dualav.com.

What to do?

1. Before you call for service, check the troubleshooting guide in your owner's manual. A slight adjustment of any custom controls may save you a service call.
2. If you require service during the warranty period, you must carefully pack the product (preferably in the original package) and ship it by prepaid transportation with a copy of the original receipt from the retailer to an authorized service center.
3. Please describe your problem in writing and include your name, a return UPS shipping address (P.O. Box not acceptable), and a daytime phone number with your shipment.
4. For more information and for the location of the nearest authorized service center please contact us by one of the following methods:
 - Call us toll-free at 1-866-382-5476
 - E-mail us at cs@dualav.com

Exclusion of Certain Damages: This warranty is exclusive and in lieu of any and all other warranties, expressed or implied, including without limitation the implied warranties of merchantability and fitness for a particular purpose and any obligation, liability, right, claim or remedy in contract or tort, whether or not arising from the company's negligence, actual or imputed. No person or representative is authorized to assume for the company any other liability in connection with the sale of this product. In no event shall the company be liable for indirect, incidental or consequential damages.



Specifications

Disc	Frequency response: 20Hz-20kHz Channel separation @ 1kHz: >80dB D/A converter: 24 Bit
FM Tuner	Tuning range: 87.5MHz-107.9MHz Usable sensitivity: 10dBf 50dB quieting sensitivity: 20dBf Stereo separation @ 1kHz: 38dB Frequency response: 30Hz-13kHz
AM Tuner	Tuning range: 530kHz-1710kHz Usable sensitivity: 24uV Frequency response: 30Hz-2.3kHz
USB	Compatibility: High Speed USB 2.0 Output: 5VDC, 500mA USB Class: Mass storage class
SD	Compatibility: SD memory card & SDHC memory card
Monitor	Panel size: 7" diagonal measurement View angle (up/down/left/right): 50/70/70/70 Resolution: 800 (H) x 480 (V) Brightness (cd/m ²): 250 Contrast ratio: 500:1 Pixels: 1,152,000
General	Speaker output impedance: 4 ohms Line output voltage: 2 volts Line output impedance: 200 ohms Chassis dimensions: 7" x 7" x 2" (W x D x H)

Design and specifications subject to change without notice.

Troubleshooting

General		
Problem	Cause	Action
Unit will not turn on (no power)	Yellow wire not connected or incorrect voltage Red wire not connected or incorrect voltage	Check connections for proper voltage (11-16VDC)
	Black wire not connected	Check connection to ground
	Fuse blown	Replace fuse(s)
Unit has power (but no sound)	Speaker wires not connected	Check connections at speakers
	One or more speaker wires touching each other or touching chassis ground	Insulate all bare speaker wires from each other and chassis ground
Unit blows fuse(s)	Yellow or red wire touching chassis ground	Check for pinched wire
	Speaker wires touching chassis ground	Check for pinched wire
	Incorrect fuse rating	Use fuses with correct rating
Unit has audio (but no video)	Parking brake safety circuit not connected Parking brake not applied	Check connections at parking brake Apply parking brake as described on page 24
	No video display (when in reverse)	Reverse circuit not connected Vehicle is not in reverse
DVD does not start playback	Physical defect in media Wrong region	Check media for scratches Use discs labeled "Region 1" or "All" only
IR remote does not work	Dead battery	Replace battery
Excessive skipping	Unit is not mounted correctly	Check mounting sleeve
	Physical defect in media	Check media for scratches
"Wrong Region" appears on display	Region code error	Use discs labeled "Region 1" or "All" only

For Your Records

Please keep your original sales receipt and be prepared to provide this receipt in the event you require service, as your original receipt is considered the best proof of purchase and indicates the date you purchased your Dual product.

Dealer Name _____

Dealer Phone _____

Purchase Date _____

Register Your Product

Register your product online at www.dualav.com.



Dual Electronics Corp.
Toll Free: 1-866-382-5476
Monday-Friday, 9AM-5PM

www.dualav.com

©2014 Dual Electronics Corp. All rights reserved.
NSA0814-V01