

GEEMARC

CLEAR SOUND[®]

HEAR THE DIFFERENCE

CL600

MULTIFUNCTION TELEPHONE

English





Caution: This telephone product is specifically designed for people with hearing difficulties and is provided with a handset earpiece volume control for individual requirements. Due care must be taken by all users that the handset earpiece volume control is set to the lowest level acceptable by each respective user. Care should therefore be exercised to ensure that any new users are familiar with this requirement.

INDEX

DESCRIPTION

- General description 5
- LCD screen 7
- Screen display 8

INSTALLATION

- Connecting 9
- Wall mounting 11

SETTINGS

- Ringer settings 13
- Alarm and ringer settings 14
- Dialling mode (P/T) 14
- Choose the date / hour format 15
- Date and hour settings 16
- Set the language 17
- Screen contrast adjustment 18
- Auto-on hook 18
- DIM:X----->x 19
- Time break recall setting “R” function 20

USING THE PHONE

- Answer a call 21
- Make a call 24
- Use the amplifier 26
- Last number redial 26
- Recall one of the last 30 number dialled 27

INDEX

- Delete one of the last 30 numbers dialled	27
- Mute button	28
- R, * and # keys	28
- Store a telephone number in memory	29
- Dialling stored numbers	30
- Use the headset (option)	30
- Use the neckloop (option)	31
- Use the shaker (option)	33

SENDING LEVEL SETTINGS	34
-------------------------------	-----------

RECEIVING TONE AND VOLUME SETTINGS	35
---	-----------

LINE REMOTE MONITOR

- Activate the surveillance function	37
- How to change the code to hook off	38
- Using surveillance distance function	39

SOS FUNCTION

- Set SOS number	41
- Record SOS message	42
- Play SOS message	44
- Use SOS function	44
- Hands free mode setting on, for SOS function	45
- Remote control description	47
- Change the remote control battery	47

INDEX

PHONE BOOK

- Create an entry 49
- Create an entry from the incoming call list 51
- Delete a phone book entry 52
- Modify a phone book entry 52
- Make a call from a phone book entry 53

CID FEATURE

- Use the Incoming call list 54
- Recall a number from the CID list 56
- Delete a record from the CID list 57
- Delete all records from the CID list 58
- Call waiting 58
- Message waiting 60

GUARANTEE 61

RECYCLING DIRECTIVES 62



For product support and help visit our website

at www.geemarc.com

telephone 01707 384438

or fax 01707 372529

DESCRIPTION

1 – GENERAL DESCRIPTION

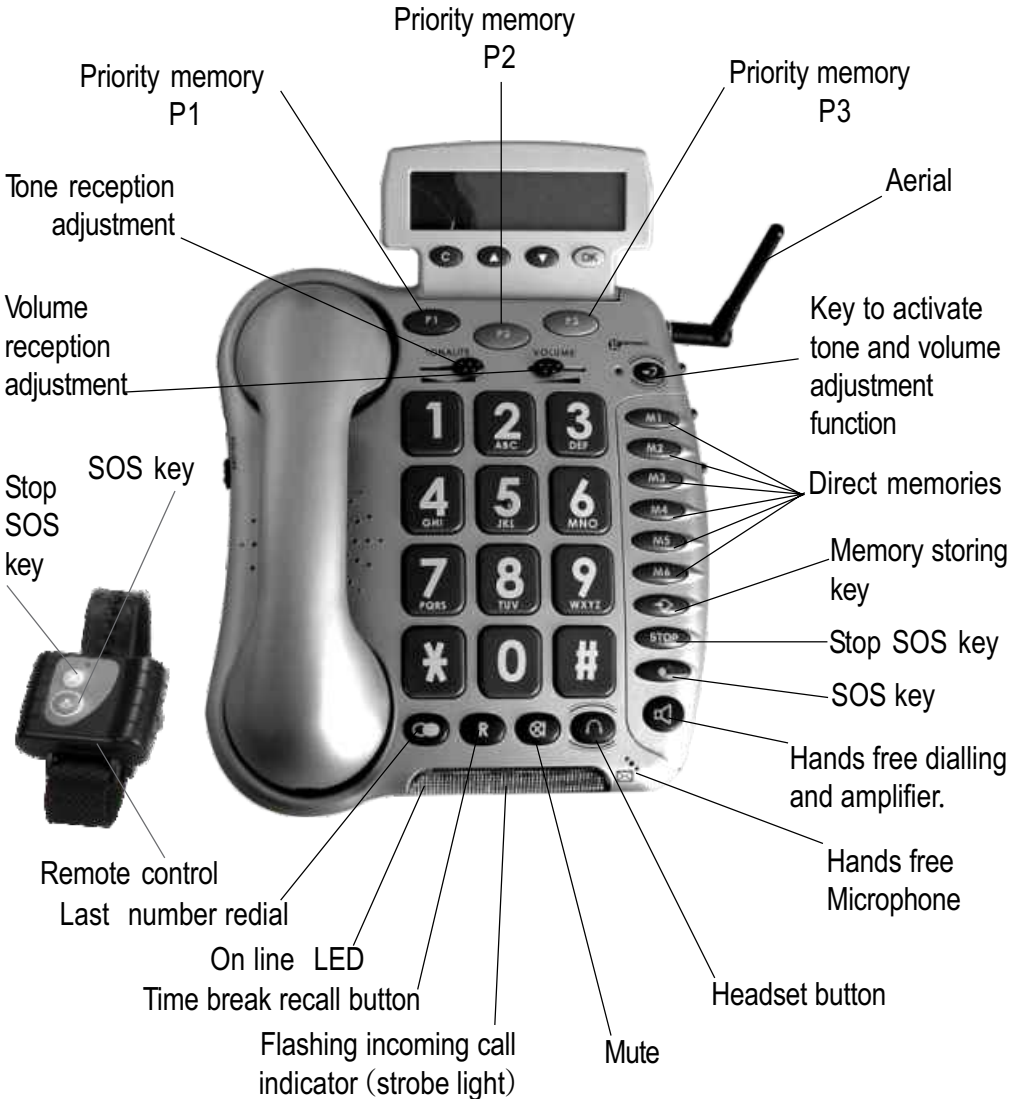

DESCRIPTION

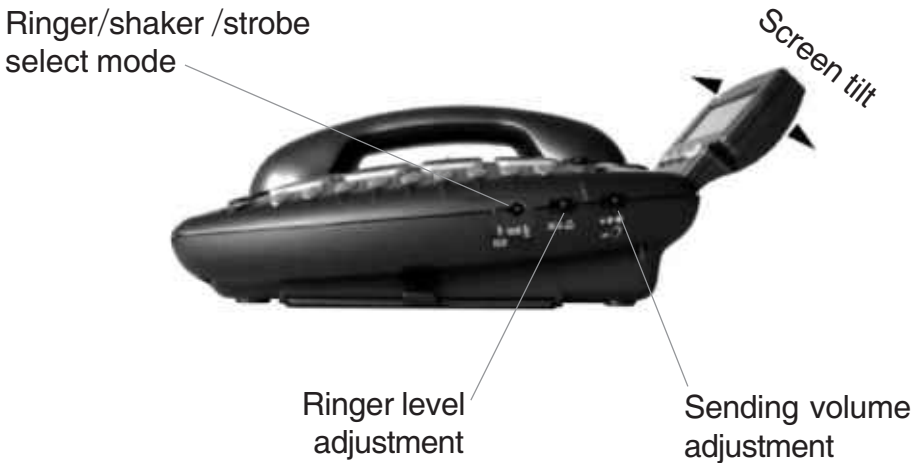

DESCRIPTION

2 – LCD SCREEN

Screen example (On hook position)

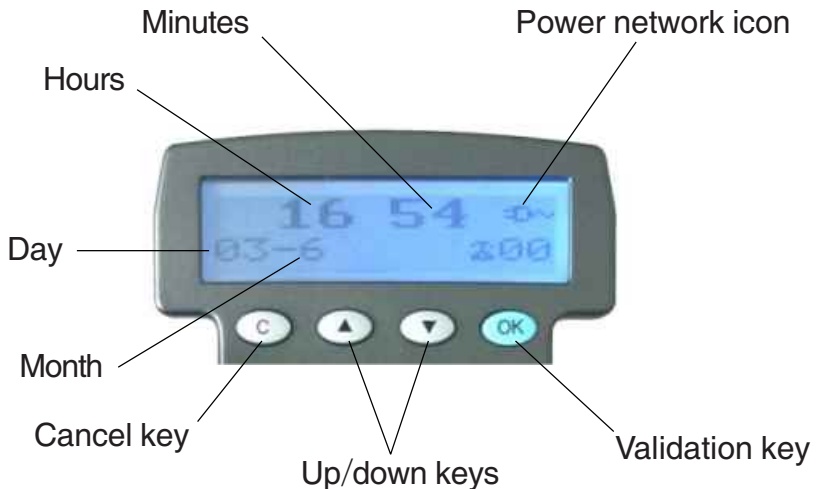

- **OK** key is used to confirm action or a choice on the screen.
- **▲ ▼** keys are used to scroll through the menu.
- In general, the **C** key is used to cancel an action/entry, it can also be used to confirm a choice (for example to cancel a stored number).

DESCRIPTION

3 – SCREEN DISPLAY

Your CL600 has a screen with different icons which help you to use the telephone.



The telephone is supplied by battery + battery indicator



The telephone is supplied by adaptor



Memory storing is required.



Screen contrast level.



“Mute” is activated.



Speaker is activated.



Precede the CID call record number.



To show new records.

INSTALLATION

1 – CONNECTING



(*) Classified TNV-3 according to EN60950 standard.

(*) Classified "hazardous voltage" according to EN60950 standard.

Important: Only Shaker, Neckloop, Headset and Adaptor with Geemarc reference can be connected to the CL600 sockets.

- Connect the handset.
- Open the battery compartment (remove the screws).
- Insert 4 alkaline batteries without mercury (AAA 1.5V type not supplied) with good polarity into the compartment located on the telephone base.

Note : Do not use a rechargeable battery, do not put the battery into the household rubbish. Pay attention to the battery regulations regarding battery disposal.

- Replace the battery cover.

INSTALLATION

– Connect the adaptor plug to the adaptor socket located on the back of the telephone then connect it to the wall socket (**). Please choose an adaptor wall socket near your line plug to enable you to unplug the adaptor quickly in case of a problem.

If you wish to change the language see page 16.

Note: The adaptor is required for the telephone to work correctly. Batteries are necessary in case of network power failure to save stored numbers in memory and are required for phone book use. If the adaptor is accidentally unplugged (or in case of power failure) and if the batteries are empty or not in place, minimal restricted phone features only will work on the phone (make a call or answer incoming call).

INSTALLATION

2 – WALL MOUNTING

To wall-mount your telephone, slide out the clip, turn around and slide back into the wall mounting position. This will ensure that the handset stays firmly in position.



Make 2 holes in the wall 80mm apart (use the wall mount template), insert the wall plugs and the wall mounting screws.

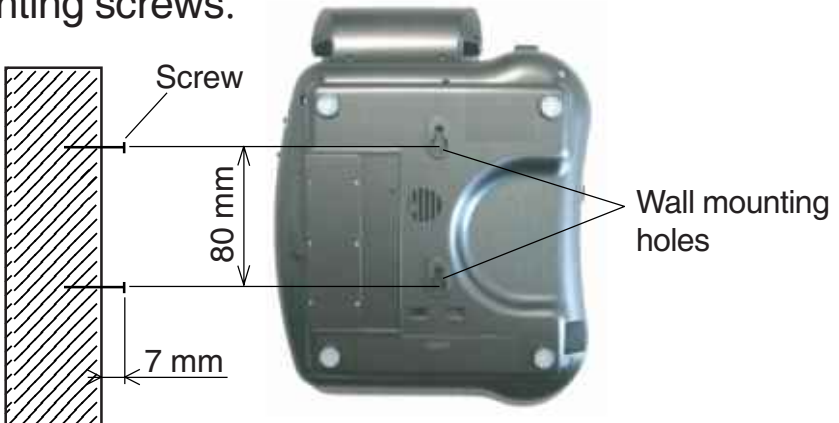

The screws should protrude from the wall by 6–7 mm. Place the phone onto the screw-heads and slide down to secure.

INSTALLATION

WALL MOUNT TEMPLATE

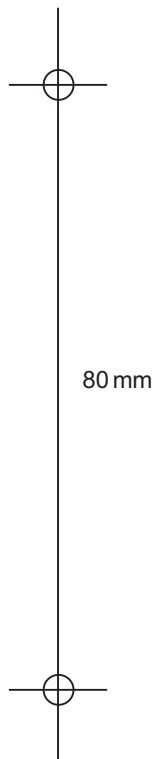

SETTINGS

1 – RINGER SETTINGS

A switch located on right side allows the ringer to be switched HI,LOW,OFF:

 : Off



 : Low

 : Hi

Your phone comes with the ringer switched to «High»

You can choose the ringer melody as follow:



In on hook position,

- Press the  key.
- Use the  or  keys to select «**SET PHONE**»
- Press the **OK** key to confirm.
- Select «**SET RING**»
- Press the **OK** key to confirm.
- Select the wanted ring.
- Press the **OK** key to confirm.
- New ring will be heard.
- Press the **C** key 3 times to exit.

SETTINGS

2 – ALARM AND RINGER SETTINGS



A 3 position switch located on the right side of the phone allows the settings below:

-  : Ringer and strobe flash are activated.
-  : Ringer and shaker are activated.
-  : Ringer, shaker and strobe flash are activated.

3 – DIALLING MODE (T/P)

The Tone/Pulse is factory pre-set to Tone(T) . In the UK, all telephone exchanges now use Tone dialling. If your phone does not dial out, it is probably being used from an older private switch-board (PBX). In this case, the Tone/Pulse setting must be moved to Pulse (P).

In on hook position,

- Press the  key.
- Use the  or  keys to select **«SET PHONE»**

SETTINGS

- Press the **OK** key to confirm.
- Select «**-tone mode or pulse mode**»
- Press the **OK** key to confirm.
- Press the **C** key 3 times to exit.



4- CHOOSE THE DATE / HOUR FORMAT

Date format

You can choose between two formats:

Day – Month or Month – Day.

In on hook position,

- Press the  key.
- Use the  or  keys to select «**SET PHONE**»
- Press the **OK** key to confirm.
- Select «**DATE FORMAT**»
- Press the **OK** key to confirm.
- Select «**DAY-MONTH**» or «**MONTH-DAY**»
- Press the **OK** key to confirm.
- Press the **C** key twice to exit.

Hour format

You can choose between two formats:

12 hours or 24 hours.

SETTINGS

In on hook position,

– Press the  key.

Use the  or  keys to select **«SET PHONE»**

– Press the **OK** key to confirm.

– Select **«HOUR FORMAT»**

– Press the **OK** key to confirm.

– Select **«12 HOUR»** or **«24 HOUR»**

– Press the **OK** key to confirm.

– Press the **C** key twice to exit.

If you choose **«12 HOUR»** hours before noon will be displayed with **«AM»** and **«PM»** for the hours after noon.



5 – DATE AND HOUR SETTING

In on hook position,

– Press the  key.

– Use the  or  keys to select **«SET TIME»**

– Press the **OK** key to confirm.

– Use the  or  keys to select the desired digit.

– Press the **OK** key to confirm and pass to the next digit.

SETTINGS

You will set the time like this:

HOURS – MINUTES – MONTH – DAY

– Press the **C** key to exit.

Note: When you receive your first call, all these parameters will be set automatically if you have the CID feature.

6 – SET THE LANGUAGE

You can choose between 16 different languages including English and French .

To change the language (ex: french to english) follow the settings as below:

In on hook position,

- Press the **⊗** key.
- Use the **▲** or **▼** keys to select **«REG TEL»**.
- Press the **OK** key to confirm.
- Select **«LANGAGE»** .
- Press the **OK** key to confirm.
- Select **«English»** (for example).
- Press the **OK** key to confirm.
- Press the **C** key twice to exit.





SETTINGS

7 – SCREEN CONTRAST ADJUSTMENT

Your screen has a backlight which automatically switches off after 15 seconds of inactivity.

Please see below to decrease or increase the contrast:

In on hook position,







- Press the  key.
- Use the  or  keys to select **«SET PHONE»**
- Press the **OK** key to confirm.
- Select **«LCD CONTRAST»**
- Press the **OK** key to confirm.
- Use the  or  keys to adjust the contrast level.
- Press the **C** or the **OK** keys to exit.

8 – AUTO- ON HOOK

This function releases the line after 8 seconds if the line is busy.

In on hook position,



SETTINGS

- Press the  key.
- Use the  or  keys to select **«SET PHONE»**
- Press the **OK** key to confirm.
- Use the  or  keys to select **«AUTO ON HOOK»**
- Press the **OK** key to confirm.
- Use the  or  keys to select **«ON»** or **«OFF»** to activate or deactivate the function.
- Press the **OK** key to confirm.
- Press the **C** key twice to exit.

10 – DIM:X----->x

If the auto-screen sizing is activated, the screen can display up to 18 digits of the number you dial, otherwise only 8 digits will be displayed on the screen.

In on hook position,

- Press the  key.
- Use the  or  keys to select **«SET PHONE»**
- Press the **OK** key to confirm.

SETTINGS

- Use the ▲ or ▼ keys to select 《DIM:X--->x》
- Press the **OK** key to confirm.
- Use the ▲ or ▼ keys to select 《**ON**》 or 《**OFF**》 to activate or deactivate the function.
- Press the **OK** key to confirm.
- Press the **C** key twice to exit.

11 – TIME BREAK RECALL SETTING “R” FUNCTION

Your phone works with a time break recall for United Kingdom (R=100ms).

If you wish to change this value, follow instructions below:

In on hook position,

- Press the ☒ key.
- Use the ▲ or ▼ keys to select 《**SET PHONE**》
- Press the **OK** key to confirm.
- Use the ▲ or ▼ keys to select 《**SET FLASH**》
- Press the **OK** key to confirm.
- Select a new setting, 300 or 600ms and press **OK** to confirm.
- Press the **C** key twice to exit.

USING THE PHONE

1 – ANSWER A CALL



When the phone rings, the Name/Number of the caller will appear on the screen, if you have subscribed to the CID service.

1st solution :

- Lift the handset and speak.
- On completion of the call, replace the handset in the cradle to release the line.

2nd solution :

You can use the «hands free» function to speak with your caller without lifting the handset.

- Press the  key to speak with your caller hands free.
- Press the  key to release the line.

3rd option:

With your remote control unit, you can answer without approaching the telephone.

- When your phone rings, press the  key on your remote control unit and the phone will be

USING THE PHONE



switched over “hands free” mode.

- On completion of the call, press  key to release the line.

2 – AUTOMATIC “HANDS FREE” FUNCTION

This function can be preset to your phone if you wish to distantly answer selected incoming calls without using your remote control unit.



To activate this function, follow the instructions below:

- In on hook position press the  key.
- Use the  or  keys to select “**SET SOS**”.
- Press the **OK** key to confirm your selection.
- Select “**Auto turn**”.
- Press the **OK** key again to confirm.
- Select “**On**” (“**Off**” to deactivate).
- Press the **OK** key to confirm.
- Press **C** key twice to exit.

USING THE PHONE

SETTING/MODIFYING CALLER PIN CODE

This function sets the speakerphone on to identify the selected number for automatic “hands free” function. The PIN code is factory preset to the **sequence 1234**. If you wish to modify it, follow the instructions below:

- In on hook position, press the  key.
- Use the  or  keys to select “**SET SOS**”.
- Press the **OK** key to confirm your selection.
- Select “**PIN CODE**”.
- Press the **OK** key again to confirm.
- Use the **C** key to delete preset digits.
- Enter your new code (max 4 digits).
- Press the **OK** key to confirm.
- Press **C** key twice to exit.

USING THE PHONE

3 – MAKE A CALL

1st solution

- Lift the handset.
- Await the dial tone and dial required number (the number is displayed on the screen).

The **C** key allows you to come back to delete a wrong digit when dialling the number.

- On completion of the call, replace the handset in the cradle to clear the line.

2nd solution (Pre-dialling)

- Dial the required number in the on hook position. The **C** key allows you to come back to delete a wrong digit when dialling the number.

– Lift the handset, the number will be automatically dialled .

- On completion of the call, replace the handset in the cradle to clear the line.



3rd solution (hands free)

You can use the « hands free » function to make a call.



- Dial the required number in the on hook position.

USING THE PHONE

The **C** key allows you to come back to delete a wrong digit when dialling the number.

- Press the  key, the number will be automatically dialled.
- When the person answers you, simply speak into the microphone located on the base. You can adjust the speaker level with the slide button located on the left side of your telephone.
- On completion of the call, simply press the  key to clear the line.

Notes: To deactivate the «hands free» function during a call, lift the handset.

The symbol  light off. The symbol  appears. To activate the «hands free» function during a call, press and hold the  key and replace the handset on the cradle at the same time.

Call time counter will be displayed a few seconds after the call is engaged.

- If you wish to stop the time counter, press the **C** key.
- If you press **C** key twice, the time counter will be reset to 0.



USING THE PHONE

4 – USE THE AMPLIFIER

During a call, if you wish to use the amplifier function with the speaker phone:



- Press the  key.
- Adjust the sound level with the **VOLUME** slide button located on the left side of your telephone.

During a call, if you wish to use the «hands free» function:

- Press and hold the  key and replace the handset on the cradle at the same time.
- Then release the  key.
- Hands free function is activated.

5 – LAST NUMBER REDIAL

With this function you can redial the last number called.

- Lift the handset or press the  or .
- Await the dial tone and press  button.
- The previously dialled number will be automatically redialled (not in use for memory numbers).
- Press **OK** to confirm.

USING THE PHONE

6 – RECALL ONE OF THE LAST 30 NUMBERS DIALLED

You can call back the last 30 numbers dialled.
To call back one of them, follow instructions below:

In on hook position,

– Press the **OK** key.

Screen will display “**DIALLED**”, the last number dialled, the total of numbers, the date and the hour of records.

– Use the ▲ or ▼ keys to move into the record menu and select the number you wish to dial.

– Lift the handset or press the , the number will be automatically dialled.

7 – DELETE ONE OF THE LAST 30 NUMBERS DIALLED

In on hook position,

– Press the **OK** key.

Screen will display “**DIALLED**”.

USING THE PHONE

- Use the ▲ or ▼ keys to move into the record menu and select the number you wish to delete.
- Press the **C** key.

The screen will display “**DEL?**”.

- Press again the **C** key to confirm.
- Press the **OK** key to exit.

8 – MUTE FUNCTION

If you wish, you can speak privately to someone else in the room without your caller overhearing. You will still be able to hear the caller but he cannot hear you during the mute operation.

- During a call press the ⊗ key.

The screen will display  X .

Your caller cannot hear you anymore.

- Press the ⊗ key to resume the conversation.

9 – R, * and # KEYS

These are used with the new services provided on digital exchanges. For details please contact your network operator.

USING THE PHONE

10 – STORE A TELEPHONE NUMBER IN MEMORY

Your phone can store 8 direct memories including 3 priority numbers (30 digits maximum for each memory).

For example, the 3 priority **P1**, **P2**, **P3** memories allow you to store the 3 numbers below:

- Local Police station,
- Your doctor
- 1471

It is recommended to store these numbers during installation



To store a number please follow instructions below:

- Lift the handset.
- Press  button.
- Dial the number.
- Press **M1**, **M2**, ..., or **M6** or one of 3 priorities numbers **P1**, **P2**, **P3** to store your number.
- The screen will display «**SAVE OK**».

Note: Numbers will be lost after a few hours if you disconnect your phone. Entering a new number in memory will automatically erase the previous number.

USING THE PHONE

11 – DIALLING STORED NUMBERS

- Lift the handset or press  or  and await the dial tone.
- Press appropriate button **M1**, **M2**, ..., or **M6** or one of the 3 priority **P1**, **P2**, **P3** numbers, the stored number will be dialled automatically. To register your stored phone numbers, use the index card located under the base. Use this table below to prepare the phone book.

Example :

	1	
	2	
	3	
	4	
	5	
	6	
	7	
	8	
	9	

Pierre	1	01 64 57 ...
--------	---	--------------

USING THE PHONE

12 – USE THE HEADSET WITH MICROPHONE (OPTION)

Headset: If you wish to answer or make a call by using a Geomarc headset ref: HEADSCL_BLK, connect the headset plug in the headset socket  located behind your phone.

- Press the  key to get the dial tone.
- Dial the number.

Note : You can adjust the reception volume and tone level with the VOLUME and TONE slide button located on the top of the phone (if function is active) and the sending level with the 3 position switch  located on the right side.

13 – USE THE NECKLOOP (OPTION)

Neckloop: If you wish to answer or make a call by using a neckloop, connect the neckloop in the neckloop plug  located behind your phone. The neckloop is now ready to be used.

USING THE PHONE

You have three possibilities to use:

1st solution:

Press the  to activate the neckloop and headset, speak into the headset microphone.

2 nd solution:

Press the  to activate the neckloop and the amplifier, speak into the microphone located on the base.

3 rd solution:

Lift the handset and speak into the handset microphone.

Note : You must connect the adaptor to use the neckloop. You can also adjust the reception level.

USING THE PHONE

14 – USE THE SHAKER (OPTION)

The shaker: If you wish to complement your phone by using a shaker ref: SHAKCL_WH connect the shaker plug in the socket (⊙) located at the back of your phone. When an incoming call is received, the shaker will be activated during ringing.

Note: This option must be set in the ALARM AND RINGER OPTIONS item (page 12) to be activated.

Important: For your security, only connect the Geemarc SHAKCL_WH model, any other shaker model can damage your telephone.

SENDING LEVEL

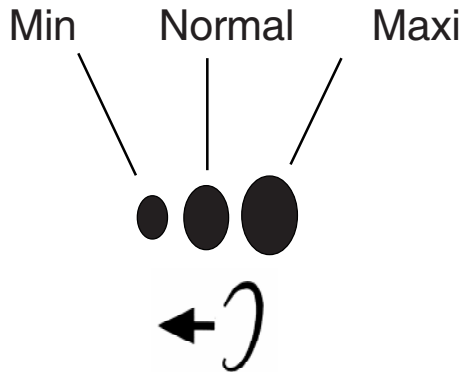

1 – SENDING LEVEL ADJUSTMENT

If your voice is quiet or called parties have difficulty hearing you, you can increase the sending level volume with the switch located on the right side. You can also decrease the sending volume if required.



RECEIVING TONE AND VOLUME

1 – VOLUME AND TONE RECEIVING ADJUSTMENT





You can increase the volume and adjust the receiving tone according to your own hearing requirements. The button  allows extra-receiving and tone functions to be activated during the conversation. When the function is activated, the red light for extra-receiving and tone function located near the button  is lit. Use the **TONE** and **VOLUME** buttons to adjust the level according to your own hearing requirements.

Note: Tone and volume adjustment (15dB to 30dB) is only activated when the button  is set to **ON**. When this button is set to **OFF** only the volume can be adjusted from 0dB to 15dB.

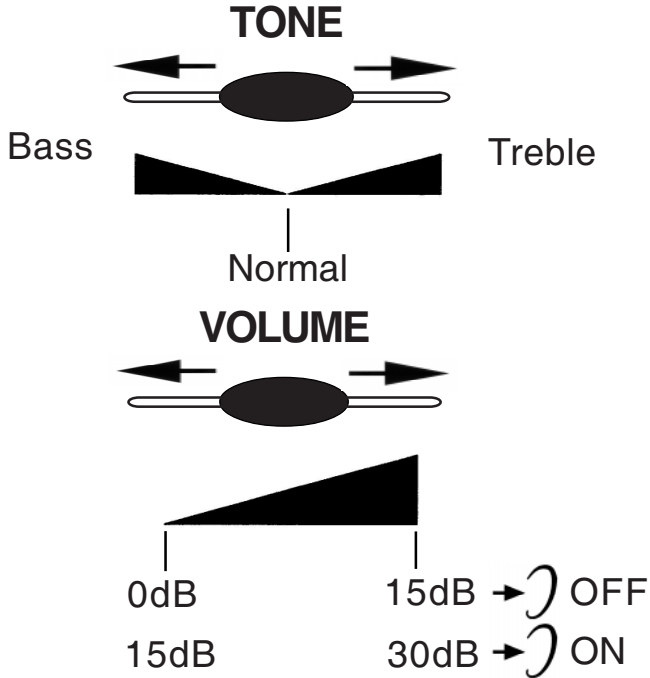
In both cases you can increase the reception volume with the switch located on the handset to 12 dB (see general description for location). While pressing this button the handset is muted.

RECEIVING TONE AND VOLUME





Note: When the tone (treble), earpiece volume and sending levels are set to the maximum, whistling may appear. If whistling occurs the sending level settings should be decreased (sending level switch  located on the right side). When the switch  located behind the phone is **ON**, the extra-receiving and tone functions are automatically activated each time you use the phone. When the switch  is switched **OFF**, you will need to activate the function by pressing the button  .

LINE REMOTE MONITOR

This function allows a caller to have a conversation with the called person using hands free mode. The called person doesn't need to pick up the handset. The phone automatically enters hands free mode.

1 - ACTIVATE THE LINE REMOTE MONITORING FUNCTION

In hook on mode

- Press key 
- Use the  or  keys to select «SET SOS»
- Press OK to confirm
- Select «AUTO TURN ON»
- Press OK to confirm
- Select «ON»
- Press OK to confirm
- Press twice «C» to exit

LINE REMOTE MONITOR

2 – HOW TO CHANGE THE CODE TO HOOK OFF

Your caller must know the code.

To start the conversation the code must be entered, once entered the hands free mode is started automatically.

Factory default setting code: **1234**

Follow the process below to modify this code

In on hook position

- Press the key ☒
- Use the ▲ or ▼ keys to select «SET SOS»
- Press OK to confirm
- Select «PIN CODE»
- Press OK to confirm
- Use «C» to delete the 4 digits
- Enter your new code (4 digits max)
- Press OK to confirm
- Press twice «C» to exit

LINE REMOTE MONITOR

3- USING SURVEILLANCE DISTANCE FUNCTION

IMPORTANT :

All answer machine systems on the same line of your CL600

must be disconnected

- Don't forget to give the code (1234 if not changed) to the people that will call you to use this function.

The feature must be set on in the installation of your CL600.

You receive a call .

After 10 ringers the person who is calling you , hears a “BIP” generated by the CL600.

Your CL600 answers automatically in hands free mode

Then the caller must enter the 4 digit code from their phone (within 10 seconds)

Now you can talk together for 2 minutes

then a new “BIP” is emitted and the caller **HAS TO PRESS A KEY (0 TO 9)** in order to keep the line connected.

LINE REMOTE MONITOR

Every 2 minutes a new «BIP» is sent
Then your caller will have to press again a key
on their phone (0-9) to keep the line connected.
Without action from your caller the CL600 will
automatically disconnect the line.

SOS FUNCTION

The SOS function allows you to ask for help conveniently when there is an emergency. To activate the function, you need to preset the SOS number and record an emergency message which will be heard by the person you contact.

Note: The adaptor must be connected . In case of power cut, the batteries are needed to assure the SOS function

1 – SET SOS NUMBER

The phone provides 6 SOS number memory locations for setting (18 digits maximum for each memory). In on hook position,

– Press the  key.

Use the  or  keys to select **«SET SOS»**

– Press the **OK** key to confirm.

– Select **«SOS NUMBER»**

– Press the **OK** key to confirm.

– Select **«SOS NUMBER 1»** or one of the others.

– Press the **OK** key to confirm.

– Dial the **SOS** number, (you can use the **C** key to delete previous digit).

SOS FUNCTION

– Press the **OK** key to confirm.

To dial the other SOS number when you are in the menu simply follow this below:

- Select «**SOS NUMBER 2**» or one of the others. and do the same as above.
- Press the **C** key three times to exit.

2 – RECORDING AN SOS MESSAGE

Your message should instruct your emergency contact that he or she should press any of 0–9 dial keys in order to be able to talk with you; otherwise your other emergency number will be automatically dialled. SOS message duration is **maximum 10 sec.**

Example of SOS message:

"Hello, (your name) is speaking. I need help. Please press any key from 0 to 9 to talk me. Thank you".

SOS FUNCTION

Notes:

1. Your emergency contact will have to press any of the 0–9 keys in succession during or immediately after hearing the SOS message. This will confirm that he or she received your emergency call and will optimize the SOS Function.

In on hook position,

– Press the  key.

Use the  or  keys to select **«SET SOS»**

– Press the **OK** key to confirm.

– Select **«SOS SOUND»**

– Press the **OK** key to confirm.

– Select **«RECORD SOUND»**

– Press the **OK** key to confirm.

– Record your **SOS** message by speaking at a correct distance from the microphone (20/30cm).

– Press the **OK** key to stop the recording.

– Press the **C** key three times to exit.

SOS FUNCTION

3 – PLAY SOS MESSAGE

In on hook position,

– Press the  key.

Use the  or  keys to select **«SET SOS»**.

– Press the **OK** key to confirm.

– Select **«SOS SOUND»**

– Press the **OK** key to confirm.

– Select **«PLAY SOUND»**

– Press the **OK** key to play the **SOS** message.

– Press the **C** key three times to exit.

4 – USE SOS FUNCTION

When your SOS numbers are set up and your SOS message is recorded, the function is ready to use whenever required.

1. Press the  key on your remote control unit or on the base unit.

2. The phone will dial the first SOS number. If there is no response within 30 seconds or the line is busy, the phone will automatically dial the second

SOS FUNCTION

SOS number. If within another 30 seconds still no response follows or the line is still busy, the phone will dial the next number (maxi twice your numbers)

3. As soon as your emergency contact lifts the handset, your SOS message will be heard (up to 5 times, if no key pressed).

4. To deactivate the SOS function on completion of the call press **X** key on your remote control unit or STOP key on the base unit.

5 – HANDS FREE MODE SETTING ON, FOR SOS FUNCTION

Activated "**ON**" by default.

In this case, the person called will have to press a key to confirm the SOS announcement has been received.

If you subscribed to an "Emergency Call Center", you may need to set to "**OFF**" mode in order the call can be accepted only when the service answers (no need to press a key).

SOS FUNCTION

Follow the steps :

- In On hook position, press ⊗.
- Use keys ▲ or ▼ to select "**SET SOS**".
- Press **OK** to confirm.
- Select "**Key Valid**".
- Press **OK** to confirm.
- Select "**OFF**".
- Press **OK** to confirm.
- Press key **C** twice to finish.

6. AUTO ON HOOK

- Enter **SET SOS** menu,
- Press **OK** key.
- Use keys ▲ or ▼ to choose **Auto on hook** menu,
- Press **OK** key to confirm.
- If you set this menu **OFF**, when you dial the EMG, the phone will send BEEP signal every 2 minutes to indicate the other party should press any key to continue the conversation.

SOS FUNCTION

7 – REMOTE CONTROL DESCRIPTION

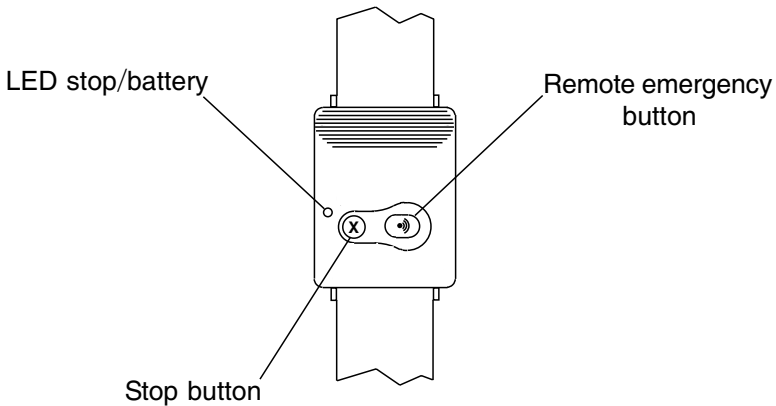

8 – CHANGE THE REMOTE CONTROL BATTERY

To replace the battery, lift the remote control band, unscrew the three little screws located on the base, lift the cover to get access to the battery. Replace the battery with correct polarity. Replace the cover.

SOS FUNCTION

Note: Do not use a rechargeable battery, do not put the battery into the household rubbish. Pay attention to the battery regulation regarding battery disposal.

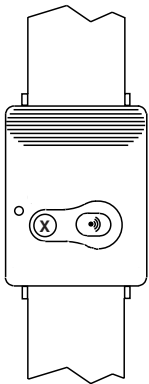

Front

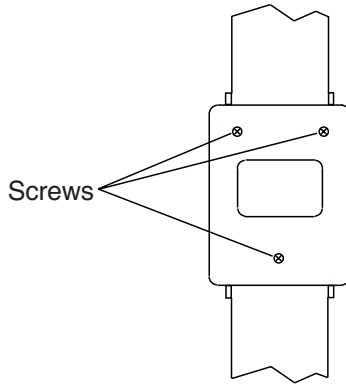

Bottom

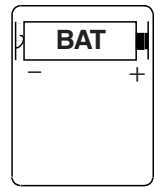



Battery location

PHONE BOOK

1 – CREATE A PHONE BOOK ENTRY

You can store 99 entries into the phone book with the name and phone numbers of your correspondent.

In on hook position,

- Press the  key.
- Use the  or  keys to select **«PHONE BOOK»**
- Press the **OK** key to confirm.
- Select **«ADD»**
- Press the **OK** key to confirm.
- Enter the number (30 digits max per memory).
- Use the **C** key to delete a wrong digit.
- When the number is correct, press the **OK** key to confirm and enter the name corresponding to entered number.
- Select the desired letter by pressing on the corresponding key.

You can use the table below or the letters printed on the keypad to help you.

PHONE BOOK

Key	Characters	Key	Characters
1	1 . , ? - " ' <	6	M N O m n o 6 Ö Ø
2	A B C a b c 2 Æ Ø	7	P Q R S p q r s 7
3	D E F d e f 3	8	T U V t u v 8 Ü
4	G H I g h i 4	9	W X Y Z w x y z 9
5	J K L j k l 5	0	0 + & @ / \$ %

- To insert a «space» press on the **OK** key twice.
- If the next character is the same as the previous character (or located on the same key), press first on the **OK** key to move and select the desired letter.
- Use the **C** key to delete a wrong letter.
- When the number is correct, press the **OK** key for 3 seconds to confirm the Number and Name storage.
- Now you can create a new entry.
- Press the **C** key to exit.

Note : If you wish to insert a pause in the stored number, press the  key whilst entering (a **P** will be displayed on the screen).

PHONE BOOK

2 – CREATE AN ENTRY FROM THE INCOMING CALL LIST

If you have subscribed to a caller identification service (CID feature), you have the possibility to create an entry from the incoming call list because each call is stored into the phone book as a CID entry.





In on hook position,

- Incoming calls will be displayed on the screen.
- Use the ▲ or ▼ keys to select the number you wish to store into the phone book.
- Press and hold the **OK** key until the last number digit flashes.
- Press the **OK** key.
- You can now modify and enter the name of the caller or press and hold for 3 seconds the **OK** key to confirm the proposed CID name.
- Press the **C** key to exit.

PHONE BOOK





3 – DELETE A PHONE BOOK ENTRY

In on hook position,

- Press the  key.
- Use the  or  keys to select **«PHONE BOOK»** then **«REVIEW»**
- Use the  or  keys to select the number you wish to delete.
- Press the **C** key, screen displays **«DEL?»**
- Press the **C** key to confirm.
- Press the **OK** key to exit.

4 – MODIFY A PHONE BOOK ENTRY

In on hook position, Press the  key.







- Use the  or  keys to select **«PHONE BOOK»** then **«REVIEW»**
- Press the **OK** key.
- Use the  or  keys to select the number you wish to modify.
- Press and hold the **OK** key until the last selected number flashes.
- Press the **C** key to modify the number and insert new number.
- Press the **OK** key.



PHONE BOOK

- You can now modify the name.
- Press the **C** key to delete a letter.
- For help see the « CREATE A PHONE BOOK ENTRY » p40 to modify the name.
- Press the **OK** key for 3 seconds to confirm the new entry.
- Press the **C** key to exit.

5 – MAKE A CALL FROM A PHONE BOOK ENTRY

In on hook position, Press the  key.

- Use the  or  keys to select « **PHONE BOOK** » then « **REVIEW** » then press the « **OK** » key.
- Use the  or  keys to select the number you wish to dial. You can also get access quickly to a phone book entry by entering the first letter of the name.
- Lift the handset or press the  or .
- Number will be dialled automatically.

Note : You can review the incoming call list during a call by pressing the OK key, then use the  &  keys to move through the phone book list.

CID FEATURES

9:52	9-09		3
OUT OF AREA			

When the same caller calls several times, only the last call will be stored into the incoming call list and the screen will display +.



9:52	9-09	N 2+
654321654321		
HELEN		

Note : During the entries review, the screen will display **N** for a new entry which has not been reviewed.

When one or several new calls have been received, the new call LED flashes and the screen displays:

9:52	9-09
28	01
TOTAL	NEW

This example shows the total number of calls in the incoming call list is 28 with a new one.

To review the new calls, use the  &  keys.

CID FEATURES

1 – USE THE INCOMING CALL LIST

Associated with the CID feature, the call list allows you to store the incoming call number. When the call list memory is full, a new number will take the place of the oldest one. Each number is stored as an entry with the date, the hour and in arrival order.

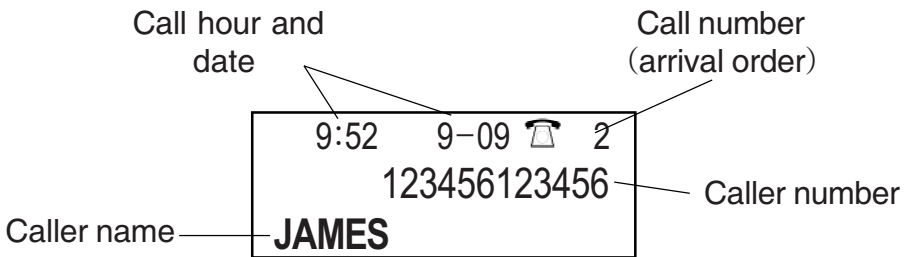

Note : If the caller does not wish to show his phone number or his name, the screen will display **PRIVATE**.



If the number is unknown from the telephone center (international incoming call for example), the screen will display **OUT OF AREA**:

CID FEATURES

16 : 53
16-6  28

When all new calls have been reviewed, the new call LED will disappear and the screen will come back to

idle state after a few seconds. The total number of incoming call entries on the incoming call list will still be displayed on the screen.

12 : 55
18-6 00

When the incoming call list is empty (if records have been deleted for example) the screen will display **00**.



2 – RECALL A NUMBER FROM THE CID LIST

You have 2 solutions :



In on hook position,

– Use the ▲ or ▼ keys to move into the list and select the required number to dial.

CID FEATURES

- Lift the handset or press the  or the  keys.
- The number will be dialled automatically.



Lift the handset,

- Use the  or  keys to move into the list and select the required number to dial.
- Press the **OK** key.
- The number will be dialled automatically.

Note : The call back function from incoming call list is not available for a number which displays **PRIVATE** or **OUT OF AREA**.

3 – DELETE A RECORD FROM THE CID LIST

In on hook position,

- Use the  &  keys to move into the list and select the required number to delete.
- Press the **C** key.
- The screen display **«DEL?»**
- Press again the **C** key to confirm.
- Press the **OK** key to exit.

CID FEATURES

4 – DELETE ALL RECORDS FROM THE CID LIST

In on hook position,

- Press the ▲ or ▼ keys to select a number.
- Press and hold the **C** key until the screen displays «**ALL DEL?**».
- Press the **C** key to confirm.

5 – CALL WAITING

With this service, you are made aware that a new call is coming through when you are in conversation. You can take this call and switch between callers. To be active, you must have subscribed to this service with your network provider.

The call waiting function is factory set to “**OFF**”
To activate this function, follow instruction below:
In on hook position,

- Press the ⊗ key.
- Use the ▲ or ▼ keys to select «**SET PHONE**»
- Press the **OK** key.

CID FEATURES

- Use the ▲ or ▼ keys to select 《**CALL WAITING**》
- Press the **OK** key.
- Use the ▲ or ▼ keys to select 《**ON**》 or 《**OFF**》
- Press the **OK** key and then **C** twice to exit.
- When you are in conversation with caller N°1. CID information will be displayed on the screen (Name and Number).

9:52	9-09		1
123456123456			
CALLER N°1			

A beep tone will be heard when a second call is incoming. Caller N° 2 CID information will be displayed on the screen (Name and Number).

9:52	9-09		1
654321654321			
CALLER N° 2			

For more information about the 《**CALL WAITING**》 service contact your network provider.

Note : If you don't answer call N°2, the call will be recorded into the incoming call list.

CID FEATURES

6 – MESSAGE WAITING

This system provides the capability of the caller to leave a message.

You will be informed of an incoming call by the incoming call list that you have a message. This call is distinguished from other calls and screen displays «**MSG WAITING**» the message waiting LED is activated, and will be cleared only after all messages be read

9:52	9-09	N 1
		3103
MSG WAITING		

Note : «**MSG WAITING**» will be displayed to indicate message not read. After review «**MSG WAITING**» will be automatically removed from the screen.



For product support and help visit our website at

www.geemarc.com

telephone 01707 384438

or fax 01707 372529

GUARANTEE

GUARANTEE

From the moment your Geemarc product is purchased, Geemarc guarantee it for the period of one year. During this time, all repairs or replacements (at our discretion) are free of charge. Should you experience a problem then contact our helpline or visit our website at www.geemarc.com. The guarantee does not cover accidents, negligence or breakages to any parts. The product must not be tampered with or taken apart by anyone who is not an authorised Geemarc representative. The Geemarc guarantee in no way limits your legal rights.

IMPORTANT: YOUR RECEIPT IS PART OF YOUR GUARANTEE AND MUST BE RETAINED AND PRODUCED IN THE EVENT OF A WARRANTY CLAIM

Please note: The guarantee applies to the United Kingdom only.

DECLARATION: Geemarc Telecom SA hereby declares that this product is in compliance with the essential requirements and other relevant provisions of the Radio and Telecommunications Terminal Equipment Directive 1999/5/EEC and in particular article 3 section 1a, 1b and section 3. The telephone does not operate if the line current is lower than 18 mA.

The declaration of conformity may be consulted at www.geemarc.com

Electrical connection : The apparatus is designed to operate from a 230V 50Hz supply only. (Classified as Hazardous voltage according to EN60950 standard). The apparatus does not incorporate an integral power on/off switch. To disconnect the power, either switch off supply at the mains power socket or unplug the AC adaptor. When installing the apparatus, ensure that the mains power socket is readily accessible.

Telephone connection : Voltages present on the telecommunication network are classified TNV-3 (Telecommunication Network Voltage) according to the EN60950 standard.



RECYCLING DIRECTIVES

The WEEE (Waste Electrical and Electronic Equipment) has been put in place for the products at the end of their useful life are recycled in the best way.

When this product is finished with, please do not put it in your domestic waste bin.

Please use one of the following disposal options:

- Deposit the product in an appropriate WEEE skip.
- Or, hand the old product to the retailer. If you purchase a new one, they should accept it.

Thus if you respect these instructions you ensure human health and environmental protection.



For product support and help visit our website

at www.geemarc.com

telephone 01707 384438

or fax 01707 372529



UGCL600_En_Ver.2.2