



Air-Conditioners

Indoor unit

PLA-RP-BA

Mr. SLIM

OPERATION MANUAL

For safe and correct use, please read this operation manual thoroughly before operating the air-conditioner unit.

FOR USER

English

Contents

| | | | |
|---|----|---|----|
| 1. Safety Precautions | 2 | 7. Other Functions | 13 |
| 2. Parts Names | 2 | 8. Function Selection | 14 |
| 3. Screen Configuration | 5 | 9. Emergency Operation for Wireless Remote-controller | 18 |
| 4. Setting the Day of the Week and Time | 5 | 10. Care and Cleaning | 18 |
| 5. Operation | 5 | 11. Trouble Shooting | 19 |
| 6. Timer | 10 | 12. Specifications | 20 |

Note (Marking for WEEE)



This symbol mark is for EU countries only.

This symbol mark is according to the directive 2002/96/EC Article 10 Information for users and Annex IV.

Your MITSUBISHI ELECTRIC product is designed and manufactured with high quality materials and components which can be recycled and reused.

This symbol means that electrical and electronic equipment, at their end-of-life, should be disposed of separately from your household waste.

Please, dispose of this equipment at your local community waste collection/recycling centre.

In the European Union there are separate collection systems for used electrical and electronic product.

Please, help us to conserve the environment we live in!

1. Safety Precautions

- ▶ Before installing the unit, make sure you read all the “Safety Precautions”.
- ▶ The “Safety Precautions” provide very important points regarding safety. Make sure you follow them.
- ▶ Please report to or take consent by the supply authority before connection to the system.

Symbols used in the text

⚠ Warning:

Describes precautions that should be observed to prevent danger of injury or death to the user.

⚠ Caution:

Describes precautions that should be observed to prevent damage to the unit.

Symbols used in the illustrations

Ⓧ : Indicates a part which must be grounded.

⚠ Warning:

- For appliances not accessible to the general public.
- The unit must not be installed by the user. Ask the dealer or an authorized company to install the unit. If the unit is installed improperly, water leakage, electric shock or fire may result.
- Do not stand on, or place any items on the unit.
- Do not splash water over the unit and do not touch the unit with wet hands. An electric shock may result.
- Do not spray combustible gas close to the unit. Fire may result.
- Do not place a gas heater or any other open-flame appliance where it will be exposed to the air discharged from the unit. Incomplete combustion may result.
- Do not remove the front panel or the fan guard from the outdoor unit when it is running.

- When you notice exceptionally abnormal noise or vibration, stop operation, turn off the power switch, and contact your dealer.
- Never insert fingers, sticks etc. into the intakes or outlets.
- If you detect odd smells, stop using the unit, turn off the power switch and consult your dealer. Otherwise, a breakdown, electric shock or fire may result.
- This air conditioner is NOT intended for use by children or infirm persons without supervision.
- Young children must be supervised to ensure that they do not play with the air conditioner.
- If the refrigeration gas blows out or leaks, stop the operation of the air conditioner, thoroughly ventilate the room, and contact your dealer.

⚠ Caution:

- Do not use any sharp object to push the buttons, as this may damage the remote controller.
- Never block or cover the indoor or outdoor unit’s intakes or outlets.

Disposing of the unit

When you need to dispose of the unit, consult your dealer.

2. Parts Names

■ Indoor Unit

| | |
|----------------------------|-----------------|
| | PLA-RP-BA |
| Fan steps | 4 steps |
| Vane | Auto with swing |
| Louver | — |
| Filter | Long-life |
| Filter cleaning indication | 2,500 hr |

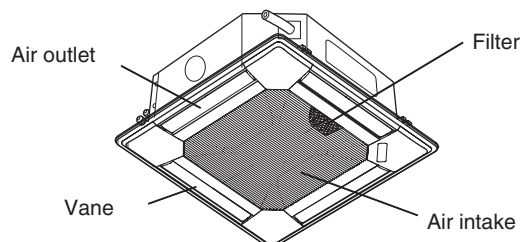

2. Parts Names

■ Wired Remote-Controller

Display Section

For purposes of this explanation, all parts of the display are shown. During actual operation, only the relevant items will be displayed.

Identifies the current operation
Shows the operating mode, etc.
* Multi language display is supported.

“Centrally Controlled” indicator
Indicates that operation of the remote controller has been prohibited by a master controller.

“Timer is Off” indicator
Indicates that the timer is off.

Temperature Setting
Shows the target temperature.

Day-of-Week
Shows the current day of the week.

Time/Timer Display
Shows the current time, unless the simple or Auto Off timer is set.
If the simple or Auto Off timer is set, shows the time remaining.

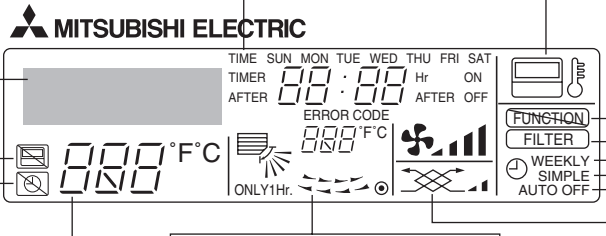

“Sensor” indication
Displayed when the remote controller sensor is used.

“Locked” indicator
Indicates that remote controller buttons have been locked.

“Clean The Filter” indicator
Comes on when it is time to clean the filter.

Timer indicators
The indicator comes on if the corresponding timer is set.

Fan Speed indicator
Shows the selected fan speed.

Ventilation indicator
Appears when the unit is running in Ventilation mode.

Up/Down Air Direction indicator
The indicator shows the direction of the outgoing airflow.

Room Temperature display
Shows the room temperature. The room temperature display range is 8–39 °C. The display blinks if the temperature is less than 8 °C or 39 °C or more.

“One Hour Only” indicator
Displayed if the airflow is set to Low and downward during COOL or DRY mode. (Operation varies according to model.)
The indicator goes off after one hour when the airflow direction also changes.

Louver display
Indicates the action of the swing louver. Does not appear if the louver is stationary.

● (Power On indicator)
Indicates that the power is on.

Operation Section

Set Temperature buttons

▽ Down

△ Up

Timer Menu button (Monitor/Set button)

Mode button (Return button)

Set Time buttons

▽ Back

△ Ahead

Timer On/Off button (Set Day button)

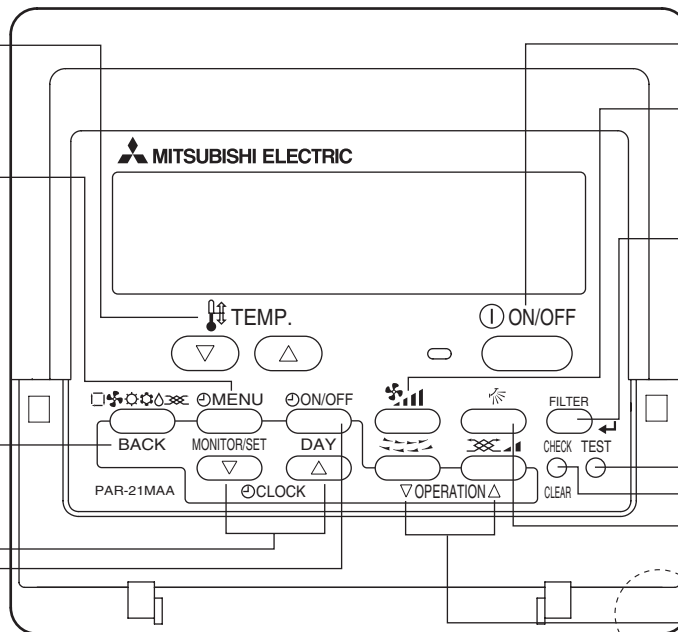
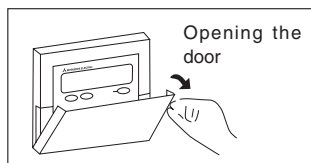

ON/OFF button

Fan Speed button

Filter button (<Enter> button)

Test Run button

Check button (Clear button)

Airflow Up/Down button

Louver button (▽ Operation button)

▽ To return operation number

Ventilation button (△ Operation button)

△ To go to next operation number

Built-in temperature sensor

Note:

- “PLEASE WAIT” message
This message is displayed for approximately 3 minutes when power is supplied to the indoor unit or when the unit is recovering from a power failure.
- “NOT AVAILABLE” message
This message is displayed if a button is pressed to operate a function that the indoor unit does not have.
If a single remote controller is used to simultaneously operate multiple indoor units that are different models, this message will not be displayed if any of the indoor units is equipped with the function.

2. Parts Names

■ Wireless Remote-Controller

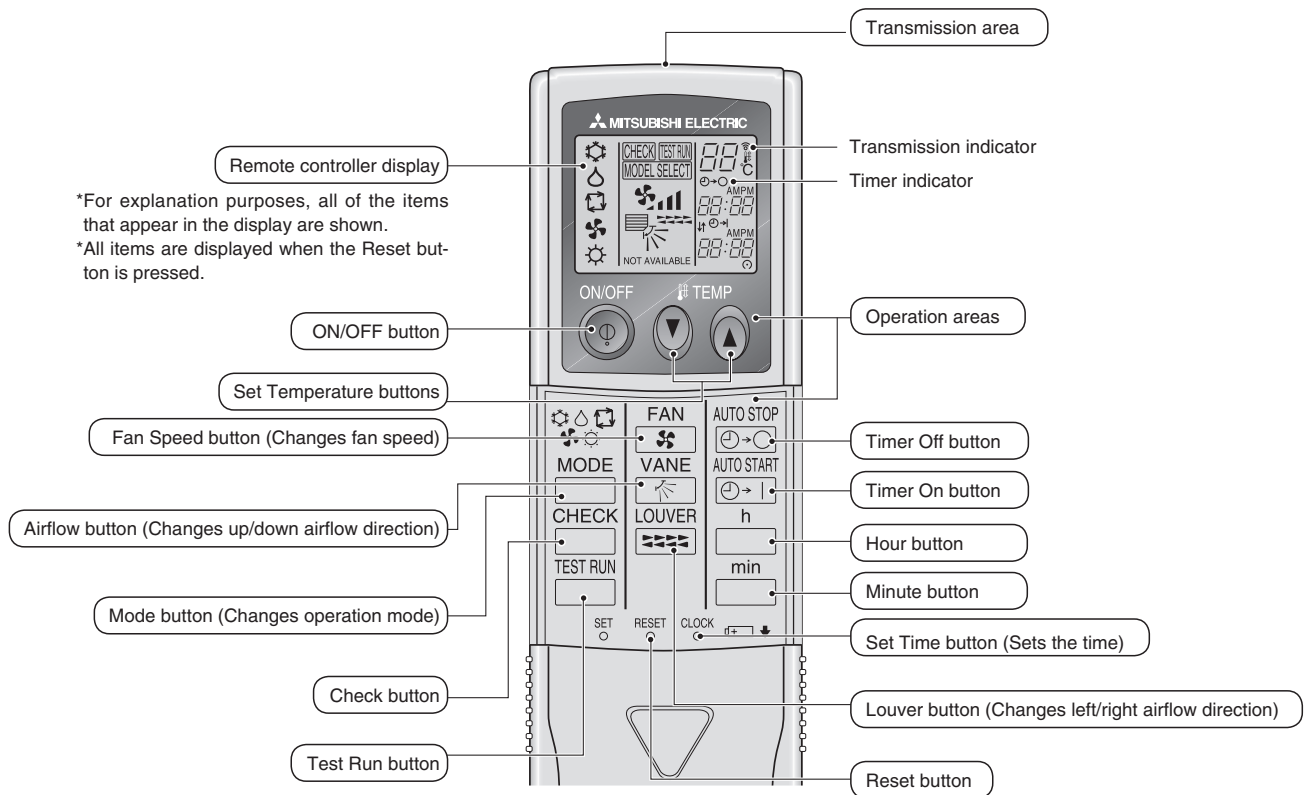

- When using the wireless remote controller, point it towards the receiver on the indoor unit.
- If the remote controller is operated within approximately two minutes after power is supplied to the indoor unit, the indoor unit may beep twice as the unit is performing the initial automatic check.
- The indoor unit beeps to confirm that the signal transmitted from the remote controller has been received. Signals can be received up to approximately 7 meters in a direct line from the indoor unit in an area 45° to the left and right of the unit. However, illumination such as fluorescent lights and strong light can affect the ability of the indoor unit to receive signals.
- If the operation lamp near the receiver on the indoor unit is blinking, the unit needs to be inspected. Consult your dealer for service.
- Handle the remote controller carefully! Do not drop the remote controller or subject it to strong shocks. In addition, do not get the remote controller wet or leave it in a location with high humidity.
- To avoid misplacing the remote controller, install the holder included with the remote controller on a wall and be sure to always place the remote controller in the holder after use.

■ Outdoor unit

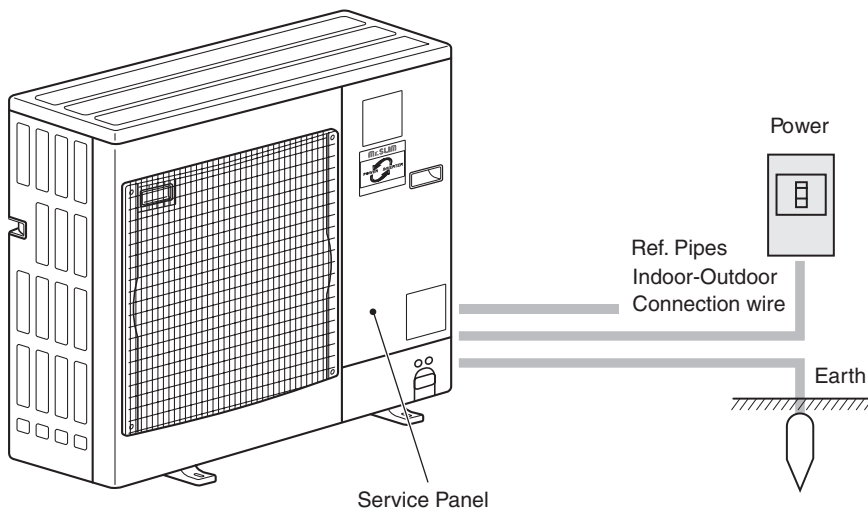

Battery installation/replacement

1. Remove the top cover, insert two AAA batteries, and then install the top cover.

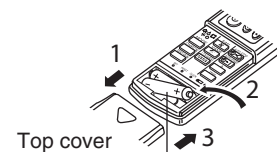

Two AAA batteries
Insert the negative (-) end of each battery first. Install the batteries in the correct directions (+, -)!

2. Press the Reset button.

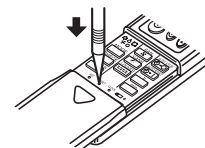

Press the Reset button with an object that has a narrow end.

3. Screen Configuration

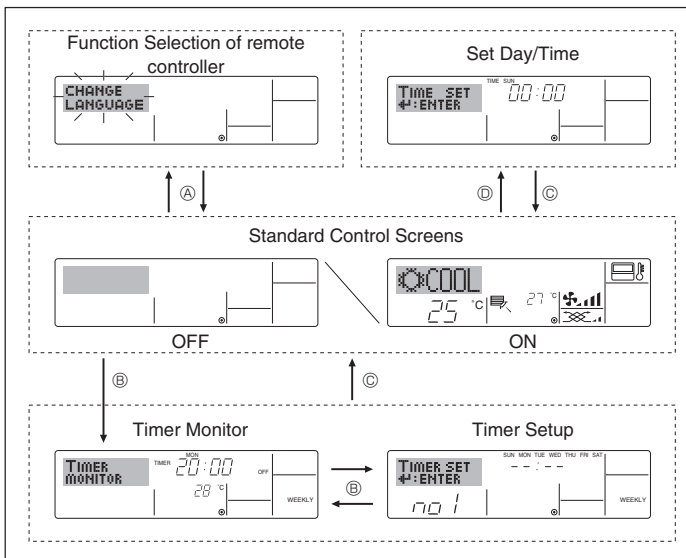

<Screen Types>

For details on setting the language for the remote controller display, refer to section 8. Function Selection.

The initial language setting is English.

● **Function Selection of remote controller:**

Set the functions and ranges available to the remote controller (timer functions, operating restrictions, etc.)

● **Set Day/Time:**

Set the current day of the week or time.

● **Standard Control Screens:**

View and set the air conditioning system's operating status

● **Timer Monitor:**

View the currently set timer (weekly timer, simple timer, or Auto Off timer)

● **Timer Setup:**

Set the operation of any of the timers (weekly timer, simple timer, or Auto Off timer).

<How to change the screen>

Ⓐ : Hold down both the Mode button and the Timer On/Off button for 2 seconds.

Ⓑ : Press the Timer Menu button.

Ⓒ : Press the Mode (Return) button.

Ⓓ : Press either of the Set Time buttons (▽ or △).

4. Setting the Day of the Week and Time

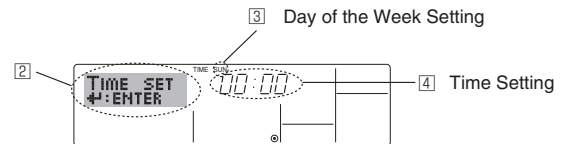
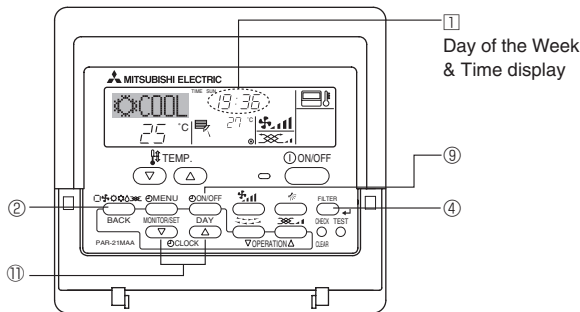

Note:

The day and time will not appear if clock use has been disabled at Function Selection of remote controller.

1. Press the ▽ or △ Set Time button ① to show display ②.

2. Press the Timer On/Off (Set Day) button ⑨ to set the day.

* Each press advances the day shown at ③ :

Sun → Mon → ... → Fri → Sat.

3. Press the appropriate Set Time button ① as necessary to set the time.

* As you hold the button down, the time (at ④) will increment first in one-minute intervals, then in ten-minute intervals, and then in one-hour intervals.

4. After making the appropriate settings at Steps 2 and 3, press the Filter ← button ④ to lock in the values.

5. Operation

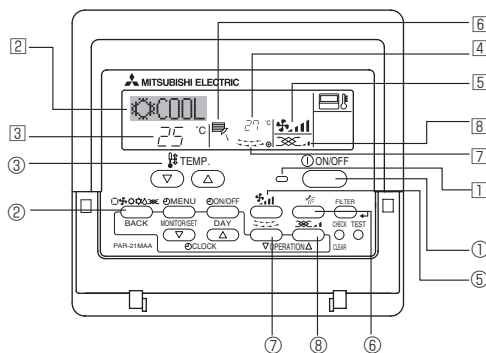

5.1. Turning ON/OFF

<To Start Operation>

■ Press the ON/OFF button ①.

- The ON lamp ② and the display area come on.

Note:

■ When the unit is restarted, initial settings are as follows.

| | Remote Controller settings |
|---------------------|----------------------------|
| Mode | Last operation mode |
| Temperature setting | Last set temperature |
| Fan speed | Last set fan speed |
| Airflow up/down | Last setting |

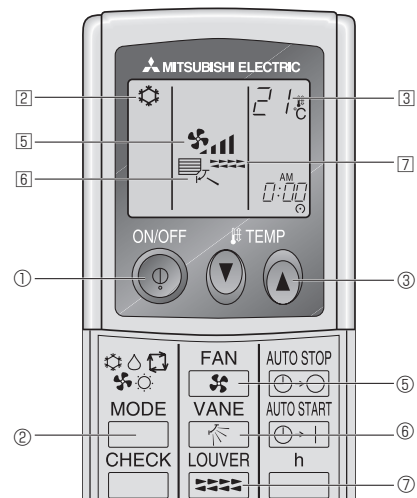

5. Operation

<To Stop Operation>

- Press the ON/OFF button ① again.
 - The ON lamp ④ and the display area go dark.

Note:

Even if you press the ON/OFF button immediately after shutting down the operation is progress, the air conditioner will not start for about three minutes. This is to prevent the internal components from being damaged.

5.2. Mode select

- Press the operation mode (□❄️🌀☀️🌬️) button ② and select the operation mode ③.

- ❄️ Cooling mode
- 🌬️ Drying mode
- 🌀 Fan mode
- ☀️ Heating mode <Only heat pump type>
- Automatic (cooling/heating) mode <Only heat pump type>
- 🌬️ Ventilation mode

Only indicated on the following condition
Wired remote controller used
LOSSNAY connected

Information for multi system air conditioner (Outdoor unit: MXZ series)

- Multi system air conditioner (Outdoor unit: MXZ series) can connect two or more indoor units with one outdoor unit. According to the capacity, two or more units can operate simultaneously.**

- When you try to operate two or more indoor units with one outdoor unit simultaneously, one for the cooling and the other for heating, the operation mode of the indoor unit that operates earlier is selected. The other indoor units that will start the operation later cannot operate, indicating an operation state in blinking. In this case, please set all the indoor units to the same operation mode.
- There might be a case that the indoor unit, which is operating in (AUTO) mode. Cannot change over to the operating mode (COOL HEAT) and becomes a state of standby.
- When indoor unit starts the operation while the defrosting of outdoor unit is being done, it takes a few minutes (max. about 15 minutes) to blow out the warm air.
- In the heating operation, though indoor unit that does not operate may get warm or the sound of refrigerant flowing may be heard, they are not malfunction. The reason is that the refrigerant continuously flows into it.

Automatic operation

- According to a set temperature, cooling operation starts if the room temperature is too hot and heating operation starts if the room temperature is too cold.
- During automatic operation, if the room temperature changes and remains 2 °C or more above the set temperature for 15 minutes, the air conditioner switches to cooling mode. In the same way, if the room temperature remains 2 °C or more below the set temperature for 15 minutes, the air conditioner switches to heating mode.

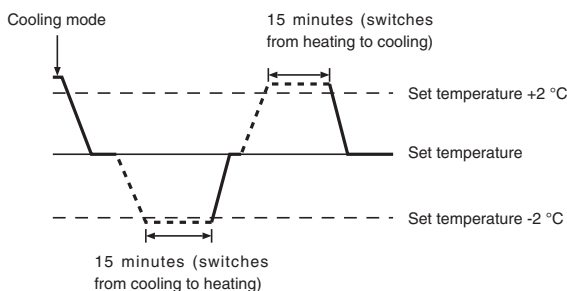

- Because the room temperature is automatically adjusted in order to maintain a fixed effective temperature, cooling operation is performed a few degrees warmer and heating operation is performed a few degrees cooler than the set room temperature once the temperature is reached (automatic energy-saving operation).

5.3. Temperature setting

▶ To decrease the room temperature:

- Press (▼) button ③ to set the desired temperature. The selected temperature is displayed ④.

▶ To increase the room temperature:

- Press (▲) button ③ to set the desired temperature. The selected temperature is displayed ④.

- Available temperature ranges are as follows:

Cooling/Drying: 19 - 30 °C
Heating: 17 - 28 °C
Automatic: 19 - 28 °C

- The display blinks either 8 °C - 39 °C to inform you if the room temperature is lower or higher than the displayed temperature. (This display does not appear on the wireless remote controller.)

5.4. Fan speed setting

- Press the Fan Speed button ⑤ as many times as necessary while the system is running.
 - Each press changes the force. The currently selected speed is shown at ⑥.
 - The change sequence, and the available settings, are as follows.

| FAN SPEED | Display |
|----------------|---------|
| 4-speed + Auto | |

Note:

- The number of available fan speeds depends on the type of unit connected.
- In the following cases, the actual fan speed generated by the unit will differ from the speed shown the remote controller display.
 - While the display is showing "STAND BY" or "DEFROST".
 - When the temperature of the heat exchanger is low in the heating mode. (e.g. immediately after heating operation starts)
 - In HEAT mode, when room temperature is higher than the temperature setting.
 - When the unit is in DRY mode.

5.5. Airflow direction setting

<To Change the Airflow's Up/Down Direction>

- With the unit running, press the Airflow Up/Down button ⑥ as necessary.
 - Each press changes the direction. The current direction is shown at ⑦.
 - The change sequence and the available settings are as follows.

| Remote controller | Display |
|-------------------|---------|
| Wired type | |
| Wireless type | |

- * Note that during swing operation, the directional indication on the screen does not change in sync with the directional vanes on the unit.

Note:

- Available directions depend on the type of unit connected.
- In the following cases, the actual air direction will differ from the direction indicated on the remote controller display.
 - While the display is showing "STAND BY" or "DEFROST".
 - Immediately after starting heater mode (while the system is waiting for the mode change to take effect).
 - In heat mode, when room temperature is higher than the temperature setting.

5. Operation

< How to set the fixed up/down air direction (Only for wired remote controller) >

Note:

● This function cannot be set depending on the outdoor unit to be connected.

- For PLA-RP-BA, only the particular outlet can be fixed to certain direction with the procedures below. Once fixed, only the set outlet is fixed every time air conditioner is turned on. (Other outlets follow UP/DOWN air direction setting of remote controller.)

Explanation of word

- "Refrigerant address No." and "Unit No." are the numbers given to each air conditioner.
- "Outlet No." is the number given to each outlet of air conditioner. (Refer to the right.)
- "Up/Down air direction" is the direction (angle) to fix.

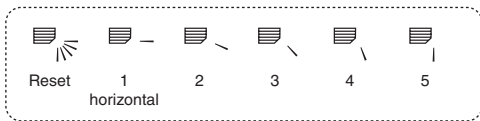

Remote controller setting

The airflow direction of this outlet is controlled by the airflow direction setting of remote controller.

Fixing

The airflow direction of this outlet is fixed in particular direction.

※ When it is cold because of direct airflow, the airflow direction can be fixed horizontally to avoid direct airflow.

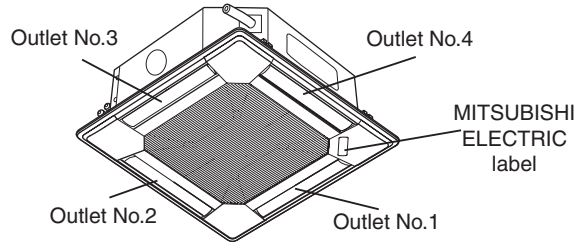

Note: "0" indicates all outlets.

Operation buttons (During the fixed airflow direction mode)

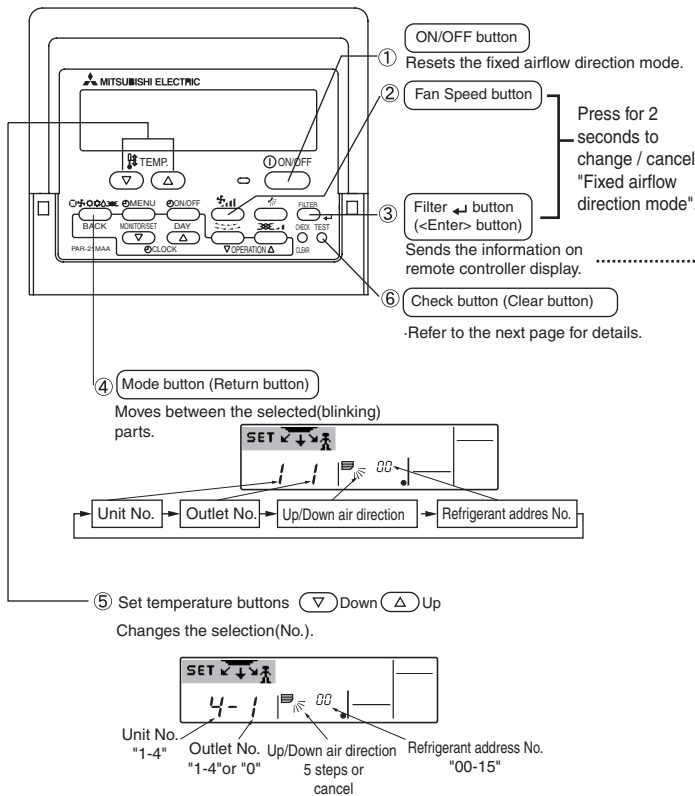

■ Pressing the button with either refrigerant address No., unit no. or outlet No. blinking, ...

Only the air conditioner with the No. on remote controller and its outlet are set to the setting 5. (Other outlets are closed.) It is used to identify the air conditioner and outlet to set.

■ Pressing the button with Up/Down air direction indicator blinking

Attention

Only the air conditioner with the No. on Remote controller and its outlet are fixed at "Up/Down air direction" blinking. This is used only to decide direction conclusively. Attention: Be careful not to set wrong air conditioner.

5. Operation

< Process for setting >

[1] To turn off air conditioner and change the remote controller to "Fixed airflow direction mode"

1. Press ON/OFF button ① to turn off the air conditioner.
2. Press Fan Speed button ② and Filter ← button ③ for more than 2 seconds simultaneously and it becomes the fixed airflow direction mode after a while.

"Fixed airflow direction mode" display

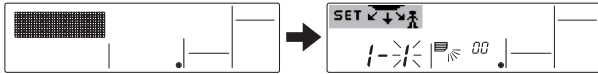

※ Air blows downward after it becomes "fixed airflow direction mode"

[2] To select and identify the outlet to set

1. Press Set Temperature button ⑤ to change number with the outlet No. blinking. Select outlet No. to set.

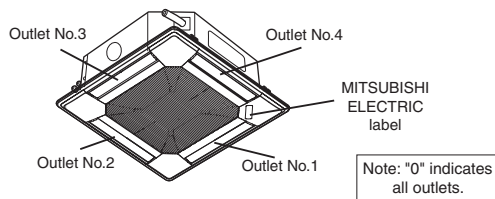
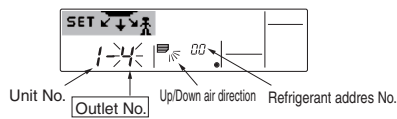

2. Press Filter ← button ③ to send the information on remote controller.
3. Wait for 15 seconds . How does the air conditioner run?
 - Only the air from the selected outlet blows downward.
 - Go to step[3].
 - Air from the wrong outlet blows downward.
 - Repeat 1 and set again.
 - All outlets are closed.
 - The numbers of the air conditioner (refrigerant address No., Unit No.) are wrong. Refer to How to find air conditioner No..

[3] To fix air direction

1. Press Mode button (Return button) ④ to blink Up/Down air direction indicator.
2. Press Set Temperature button ⑤ until the direction to set is chosen.
3. Press Filter ← button ③ to send the information on remote controller to air conditioner.
4. Wait for 15 seconds . How does the air conditioner run?
 - Airflow direction is set in the selected direction.
 - The fixed setting completed (Go to step [4].)
 - Airflow direction is set in the wrong direction.
 - Repeat 2. and set again.

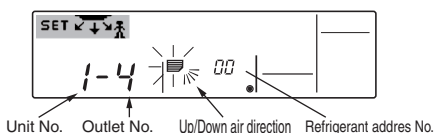

[4] To cancel "Fixed airflow direction mode"

1. Press ON/OFF button ① to cancel "Fixed airflow direction mode". It is also canceled by pressing Fan Speed button ② and Filter ← button ③ for more than 2 seconds simultaneously.
2. Do not operate remote controller for 30 seconds after the "Fixed airflow direction mode" is canceled. It does not accept even if it is operated.

5. Operation

How to find air conditioner No.

Each air conditioner has its own refrigerant address No. and unit No. (Example below). To find air conditioner No. to set, refer to the procedures below. Air conditioner No. is found by its airflow direction with the unit No. changed one after the other.

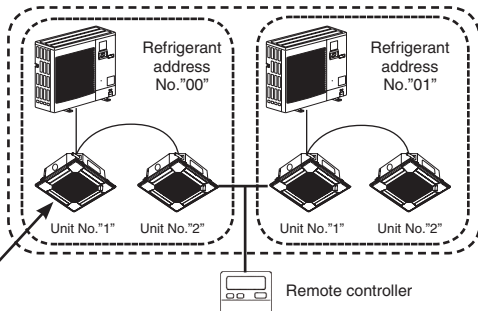

As for this air conditioner, air conditioner No. is "Unit No. 1" of refrigerant address "0".

Check from refrigerant address 00 at first.

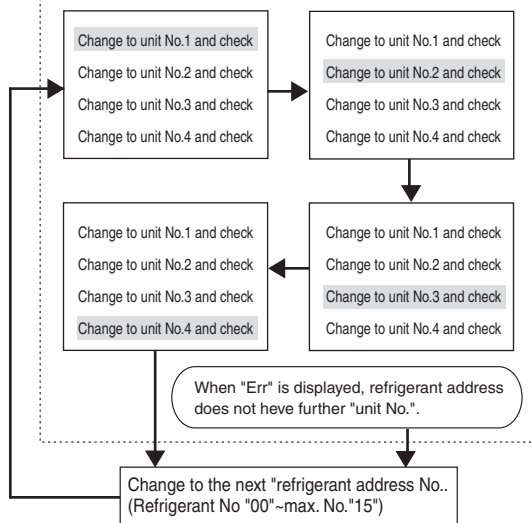

<Process to find air conditioner No.>

[1] To check refrigerant address No. and unit No.

1. Press Mode button (Return button) ④ and unit No. or refrigerant address No. blinks. Adjust refrigerant address No. to "00" and unit No. "1" with Set Temperature button ⑤.

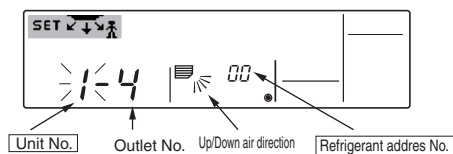

2. Press Filter button ③ to send the information on remote controller.
3. Wait for 15 seconds. How does the air conditioner run?
 - Only air from the outlet which No. displayed on remote controller blows downward.
 - Refrigerant address No. 00 and unit No. 1 are the air conditioner No..
 - All outlets are closed.
 - Go to step [2].

[2] To check by changing unit No. one after the other (Maximum unit No. is 4)

1. Press Mode button (Return button) ④ and unit No. blinks.

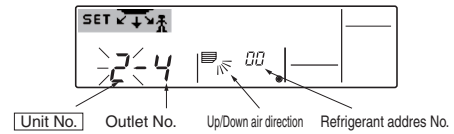

Adjust to the next unit No. with Set Temperature button ⑤. (refrigerant address No. 00 is remained.)

2. Press Filter button ③ to send the information on remote controller.
3. Wait for 15 seconds. How does the air conditioner run?
 - Only air from the outlet which No. displayed on remote controller blows downward.
 - No. displayed on remote controller is air conditioner No. (Checking completed)
 - All outlets are closed.
 - Repeat [1] and check. (If all the numbers are checked up to No. 4 and is not found, go to [3].)
 - "Err" is displayed on remote controller.
 - The refrigerant address does not have further unit No.. (Go to [3].)



[3] To check Unit No. of following refrigerant address No. (Maximum refrigerant address No. is 15)

1. Press Mode button (Return button) ④ to blink refrigerant address No.. Adjust refrigerant No. with Set Temperature button ⑤.
- * By changing refrigerant address, unit No. and outlet No. turn to initial display.
2. Go back to [2] and check Unit No. again from Unit No. 1 in order.

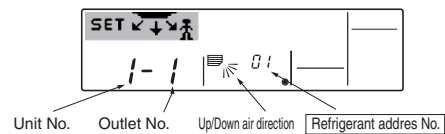

To clear fixed setting

To clear all fixed setting (reset to factory default), press check button (clear button) ⑥ for more than 3 seconds in fixed airflow direction mode. Display of remote controller blinks and the set information is cleared.

Note:

This operation clears the fixed setting information of all air conditioner connected to the remote controller.

5.6. Ventilation

► For LOSSNAY combination

5.6.1. For Wired Remote-controller

- To run the ventilator together with the indoor unit:
 - Press the ON/OFF button ①.
 - The Vent indication appears on the screen (at ⑧). The ventilator will now automatically operate whenever the indoor unit is running.
- To run the ventilator independently:
 - Press the Mode button ② until appears on the display. This will cause the ventilator to start.
- To change the ventilator force:
 - Press the Ventilation button ③ as necessary.
 - Each press toggles the setting, as shown below.

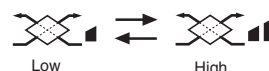

5.6.2. For Wireless Remote-controller

- The ventilator will automatically operate when the indoor unit turns on.
- No indication on the wireless remote controller.

6. Timer

6.1. For Wired Remote-controller

You can use Function Selection of remote controller to select which of three types of timer to use: ① Weekly timer, ② Simple timer, or ③ Auto Off timer.

6.1.1. Weekly Timer

■ The weekly timer can be used to set up to eight operations for each day of the week.

- Each operation may consist of any of the following: ON/OFF time together with a temperature setting, or ON/OFF time only, or temperature setting only.
- When the current time reaches a time set at this timer, the air conditioner carries out the action set by the timer.

■ Time setting resolution for this timer is one minute.

Note:

*1. Weekly Timer/Simple Timer/Auto Off Timer cannot be used at the same time.

*2. The weekly timer will not operate when any of the following conditions is in effect.

The timer feature is off; the system is in a malfunction state; a test run is in progress; the remote controller is undergoing self-check or remote controller check; the user is in the process of setting a function; the user is in the process of setting the timer; the user is in the process of setting the current day of the week or time; the system is under central control. (Specifically, the system will not carry out operations (unit on, unit off or temperature setting) that are prohibited during these conditions.)

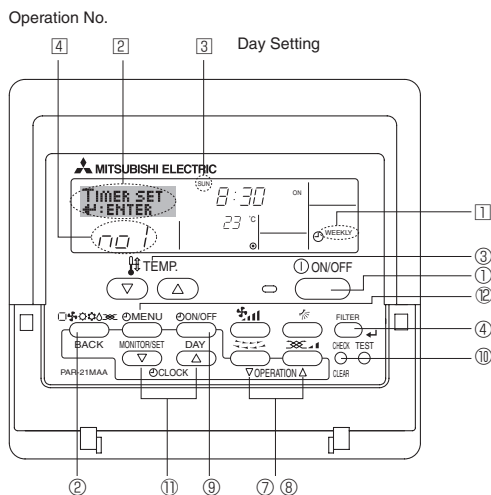

<How to Set the Weekly Timer>

- Be sure that you are at a standard control screen, and that the weekly timer indicator ① is shown in the display.
- Press the Timer Menu button ②, so that the "Set Up" appears on the screen (at ②). (Note that each press of the button toggles the display between "Set Up" and "Monitor".)
- Press the Timer On/Off (Set Day) button ③ to set the day. Each press advances the display at ③ to the next setting, in the following sequence: "Sun Mon Tues Wed Thurs Fri Sat" → "Sun" → ... → "Fri" → "Sat" → "Sun Mon Tues Wed Thurs Fri Sat"...
- Press the ∇ or ∆ Operation button (⑦ or ⑧) as necessary to select the appropriate operation number (1 to 8) ④.
 - Your inputs at Steps 3 and 4 will select one of the cells from the matrix illustrated below.
 - (The remote-controller display at left shows how the display would appear when setting Operation 1 for Sunday to the values indicated below.)

Setup Matrix

| Op No. | Sunday | Monday | ... | Saturday |
|--------|---------------------------|------------------|------------------|------------------|
| No. 1 | • 8:30 • ON • 23 °C | | | |
| No. 2 | • 10:00 • OFF | • 10:00 • OFF | • 10:00 • OFF | • 10:00 • OFF |
| ... | | | | |
| No. 8 | | | | |

<Operation 1 settings for Sunday>
Start the air conditioner at 8:30, with the temperature set to 23 °C.

<Operation 2 settings for every day>
Turn off the air conditioner at 10:00.

Note:

By setting the day to "Sun Mon Tues Wed Thurs Fri Sat", you can set the same operation to be carried out at the same time every day. (Example: Operation 2 above, which is the same for all days of the week.)

<Setting the Weekly Timer>

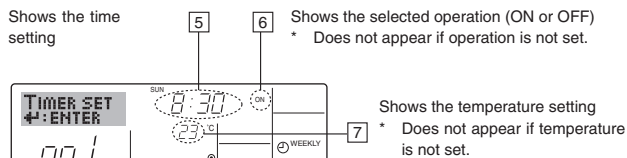

- Press the appropriate Set Time button ⑤ as necessary to set the desired time (at ⑤).
 - As you hold the button down, the time first increments in minute intervals, then in ten-minute intervals, and then in one-hour intervals.
- Press the ON/OFF button ⑥ to select the desired operation (ON or OFF), at ⑥.
 - Each press changes the next setting, in the following sequence: No display (no setting) → "ON" → "OFF"
- Press the appropriate Set Temperature button ⑦ to set the desired temperature (at ⑦).
 - Each press changes the setting, in the following sequence: No display (no setting) ↔ 24 ↔ 25 ↔ ... ↔ 29 ↔ 30 ↔ 12 ↔ ... ↔ 23 ↔ No display.
 - (Available range: The range for the setting is 12 °C to 30 °C. The actual range over which the temperature can be controlled, however, will vary according to the type of the connected unit.)
- After making the appropriate settings at Steps 5, 6 and 7, press the Filter ← button ④ to lock in the values.
 - To clear the currently set values for the selected operation, press and quickly release the Check (Clear) button ⑩ once.
 - The displayed time setting will change to "—:—", and the On/Off and temperature settings will all disappear.
 - (To clear all weekly timer settings at once, hold down the Check (Clear) button ⑩ for two seconds or more. The display will begin blinking, indicating that all settings have been cleared.)

Note:

Your new entries will be cancelled if you press the Mode (Return) button ② before pressing the Filter ← button ④.

If you have set two or more different operations for exactly the same time, only the operation with the highest Operation No. will be carried out.

- Repeat Steps 3 to 8 as necessary to fill as many of the available cells as you wish.
- Press the mode (Return) button ② to return to the standard control screen and complete the setting procedure.
- To activate the timer, press the Timer On/Off button ⑨, so that the "Timer Off" indication disappears from the screen. **Be sure that the "Timer Off" indication is no longer displayed.**
 - If there are no timer settings, the "Timer Off" indication will blink on the screen.

<How to View the Weekly Timer Settings>

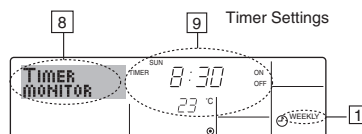

- Be sure that the weekly timer indicator is visible on the screen (at ①).
- Press the Timer Menu button ② so that "Monitor" is indicated on the screen (at ⑧).
- Press the Timer On/Off (Set Day) button ③ as necessary to select the day you wish to view.
- Press the ∇ or ∆ Operation button (⑦ or ⑧) as necessary to change the timer operation shown on the display (at ⑨).
 - Each press will advance to the next timer operation, in order of time setting.
- To close the monitor and return to the standard control screen, press the Mode (Return) button ②.

<To Turn Off the Weekly Timer>

Press the Timer On/Off button ⑨ so that "Timer Off" appears at ⑩.

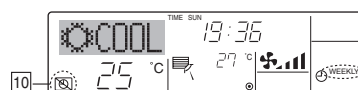

6. Timer

<To Turn On the Weekly Timer>

Press the Timer On/Off button ⑨ so that the “Timer Off” indication (at ⑩) goes dark.

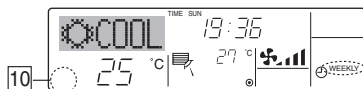

6.1.2. Simple Timer

■ You can set the simple timer in any of three ways.

- Start time only:
The air conditioner starts when the set time has elapsed.
- Stop time only:
The air conditioner stops when the set time has elapsed.
- Start & stop times:
The air conditioner starts and stops at the respective elapsed times.

■ The simple timer (start and stop) can be set only once within a 72-hour period.

The time setting is made in hour increments.

Note:

*1. Weekly Timer/Simple Timer/Auto Off Timer cannot be used at the same time.

*2. The simple timer will not operate when any of the following conditions is in effect.

The timer is off; the system is in malfunction state; a test run is in progress; the remote controller is undergoing self-check or remote controller check; the user is in the process of selecting a function; the user is in the process of setting the timer; the system is under central control. (Under these conditions, On/Off operation is prohibited.)

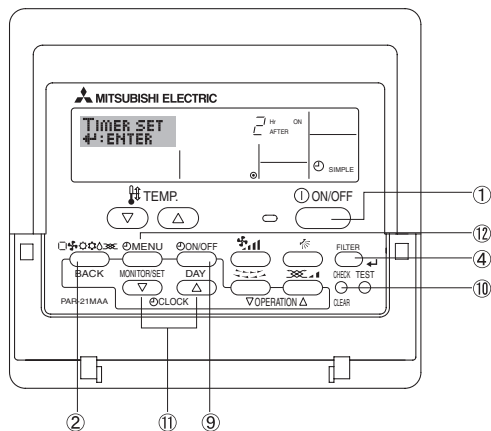

<How to Set the Simple Timer>

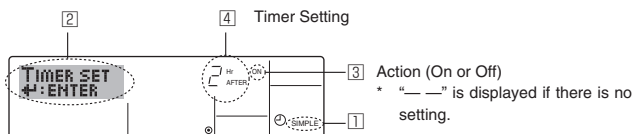

1. Be sure that you are at a standard control screen, and that the simple timer indicator is visible in the display (at ①).
When something other than the Simple Timer is displayed, set it to SIMPLE TIMER using the function selection of remote controller (see 8.[3] (3) timer function setting).
2. Press the Timer Menu button ②, so that the “Set Up” appears on the screen (at ②). (Note that each press of the button toggles the display between “Set Up” and “Monitor”.)
3. Press the ON/OFF button ① to display the current ON or OFF simple timer setting. Press the button once to display the time remaining to ON, and then again to display the time remaining to OFF. (The ON/OFF indication appears at ③).
 - “ON” timer:
The air conditioner will start operation when the specified number of hours has elapsed.
 - “OFF” timer:
The air conditioner will stop operation when the specified number of hours has elapsed.

4. With “ON” or “OFF” showing at ③: Press the appropriate Set Time button ④ as necessary to set the hours to ON (if “ON” is displayed) or the hours to OFF (if “OFF” is displayed) at ④.

- Available Range: 1 to 72 hours

5. To set both the ON and OFF times, repeat Steps 3 and 4.

* Note that ON and OFF times cannot be set to the same value.

6. To clear the current ON or OFF setting: Display the ON or OFF setting (see step 3) and then press the Check (Clear) button ⑩ so that the time setting clears to “—” at ④. (If you want to use only an ON setting or only an OFF setting, be sure that the setting you do not wish to use is shown as “—”.)

7. After completing steps 3 to 6 above, press the Filter button ④ to lock in the value.

Note:

Your new settings will be cancelled if you press the Mode (Return) button ② before pressing the Filter button ④.

8. Press the Mode (Return) button ② to return to the standard control screen.

9. Press the Timer On/Off button ⑨ to start the timer countdown. When the timer is running, the timer value is visible on the display. **Be sure that the timer value is visible and appropriate.**

<Viewing the Current Simple Timer Settings>

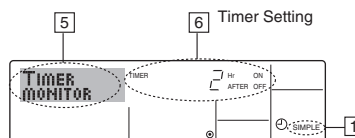

1. Be sure that the simple timer indicator is visible on the screen (at ①).

2. Press the Timer Menu button ②, so that the “Monitor” appears on the screen (at ⑤).

- If the ON or OFF simple timer is running, the current timer value will appear at ⑥.
- If ON and OFF values have both been set, the two values appear alternately.

3. Press the Mode (Return) button ② to close the monitor display and return to the standard control screen.

<To Turn Off the Simple Timer...>

Press the Timer On/Off button ⑨ so that the timer setting no longer appears on the screen (at ⑦).

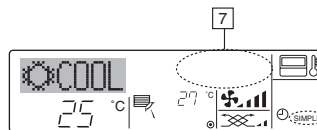

<To Turn On the Simple Timer...>

Press the Timer On/Off button ⑨ so that the timer setting becomes visible at ⑦.

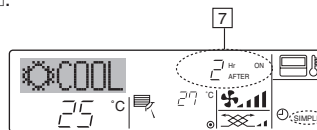

6. Timer

Examples

If ON and OFF times have both been set at the simple timer, operation and display are as indicated below.

Example 1:

Start the timer with ON time set earlier than OFF time

ON Setting: 3 hours

OFF Setting: 7 hours

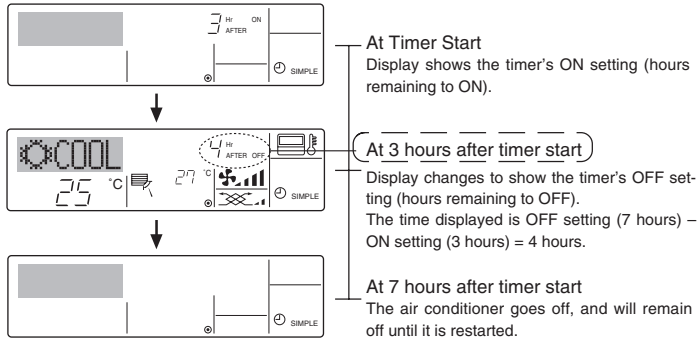

Example 2:

Start the timer with OFF time set earlier than ON time

ON Setting: 5 hours

OFF Setting: 2 hours

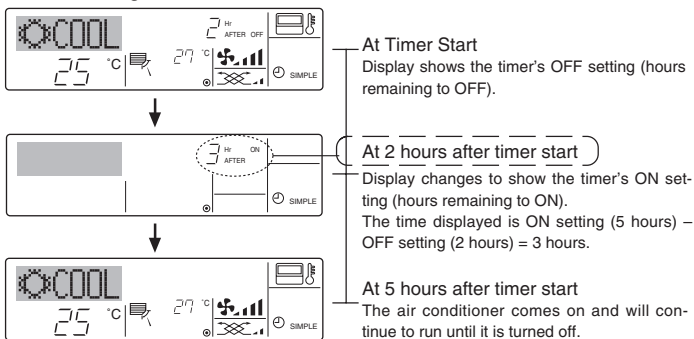

6.1.3. Auto Off Timer

■ This timer begins countdown when the air conditioner starts and shuts the air conditioner off when the set time has elapsed.

■ Available settings run from 30 minutes to 4 hours in 30-minute intervals.

Note:

- *1. Weekly Timer/Simple Timer/Auto Off Timer cannot be used at the same time.
- *2. The Auto Off timer will not operate when any of the following conditions is in effect.

The timer is off; the system is in malfunction state; a test run is in progress; the remote controller is undergoing self-check or remote controller check; the user is in the process of selecting a function; the user is in the process of setting the timer; the system is under central control. (Under these conditions, On/Off operation is prohibited.)

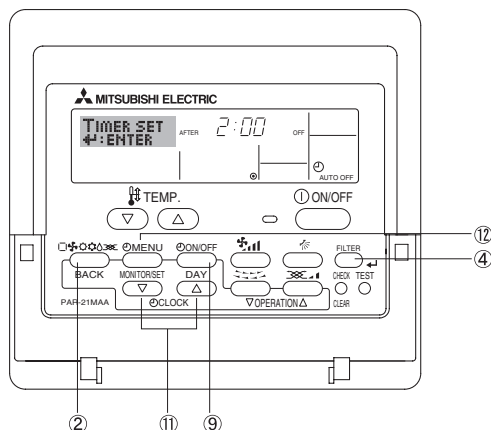

<How to Set the Auto Off Timer>

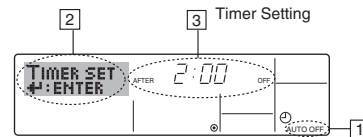

1. Be sure that you are at a standard control screen, and that the Auto Off timer indicator is visible in the display (at 1).
When something other than the Auto Off Timer is displayed, set it to AUTO OFF TIMER using the function selection of remote controller (see 8.[4]-3 (3) timer function setting).
2. Hold down the Timer Menu button 2 for 3 seconds so that the "Set Up" appears on the screen (at 2).
(Note that each press of the button toggles the display between "Set Up" and "Monitor".)
3. Press the appropriate Set Time button 1 as necessary to set the OFF time (at 3).
4. Press the Filter button 4 to lock in the setting.
Note:
Your entry will be cancelled if you press the Mode (Return) button 2 before pressing the Filter button 4.

5. Press the Mode (Return) button 2 to complete the setting procedure and return to the standard control screen.
6. If the air conditioner is already running, the timer starts countdown immediately. **Be sure to check that the timer setting appears correctly on the display.**

<Checking the Current Auto Off Timer Setting>

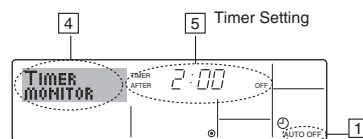

1. Be sure that the "Auto Off" is visible on the screen (at 1).
2. Hold down the Timer Menu button 4 for 3 seconds so that "Monitor" is indicated on the screen (at 4).
• The timer remaining to shutdown appears at 5.
3. To close the monitor and return to the standard control screen, press the Mode (Return) button 2.

<To Turn Off the Auto Off Timer...>

- Hold down the Timer On/Off button 9 for 3 seconds so that "Timer Off" appears (at 6) and the timer value (at 7) disappears.

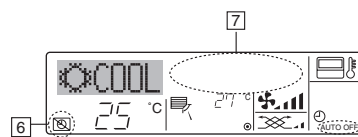

- Alternatively, turn off the air conditioner itself. The timer value (at 7) will disappear from the screen.

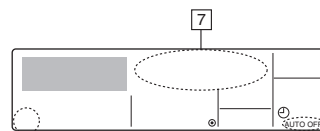

<To Turn On the Auto Off Timer...>

- Hold down the Timer On/Off button 9 for 3 seconds. The "Timer Off" indication disappears (at 6), and the timer setting comes on the display (at 7).
- Alternatively, turn on the air conditioner. The timer value will appear at 7.

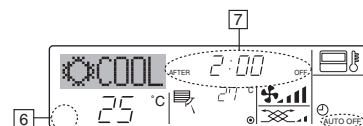

6. Timer

6.2. For Wireless Remote-controller

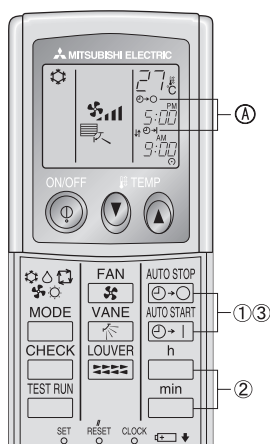

- ① Press the or button (TIMER SET).
- Time can be set while the following symbol is blinking.
OFF timer : is blinking.
ON timer : is blinking.
- ② Use the and buttons to set the desired time.
 - ③ Canceling the timer.
To cancel the OFF timer, press the button.
To cancel the ON timer, press the button.
- It is possible to combine both OFF and ON timers.
 - Pressing the ① ON/OFF button of the remote controller during timer mode to stop the unit will cancel the timers.
 - If the current time has not been set, the timer operation cannot be used.

7. Other Functions

7.1. Locking the Remote Controller Buttons (Operation function limit controller)

■ If you wish, you can lock the remote controller buttons. You can use the Function Selection of remote controller to select which type of lock to use.
(For information about selecting the lock type, see section 8, item [2] (1)). Specifically, you can use either of the following two lock types.

- ① Lock All Buttons:
Locks all of the buttons on the remote controller.
- ② Lock All Except ON/OFF:
Locks all buttons other than the ON/OFF button.

Note:
The “Locked” indicator appears on the screen to indicate that buttons are currently locked.

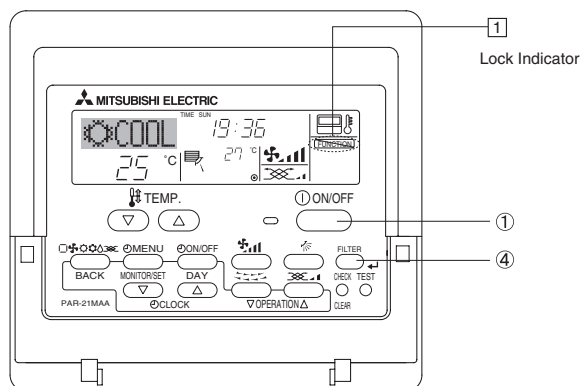

<How to Lock the Buttons>

1. While holding down the Filter button ④, press and hold down the ON/OFF button ① for 2 seconds. The “Locked” indication appears on the screen (at ①), indicating that the lock is now engaged.
- * If locking has been disabled in Function Selection of remote controller, the screen will display the “Not Available” message when you press the buttons as described above.

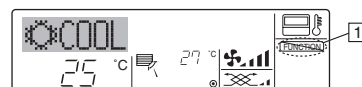

- If you press a locked button, the “Locked” indication (at ①) will blink on the display.

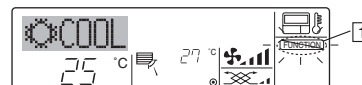

<How to Unlock the Buttons>

1. While holding down the Filter button ④, press and hold down the ON/OFF button ① for 2 seconds—so that the “Locked” indication disappears from the screen (at ①).

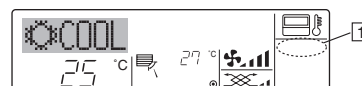

7. Other Functions

7.2. Error Codes indication

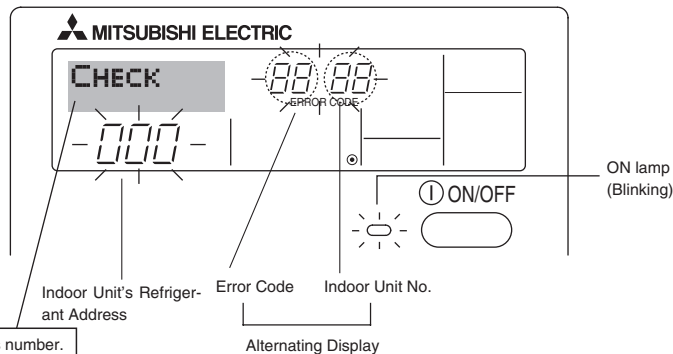

If you have entered contact number to be called in the event of a problem, the screen displays this number. (You can set this up under Function Selection of remote controller. For information, refer to section 8.)

- If the ON lamp and error code are both blinking: This means that the air conditioner is out of order and operation has been stopped (and cannot resume). Take note of the indicated unit number and error code, then switch off the power to the air conditioner and call your dealer or servicer.

When the Check button is pressed:

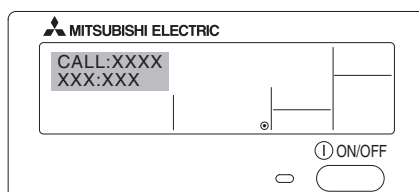
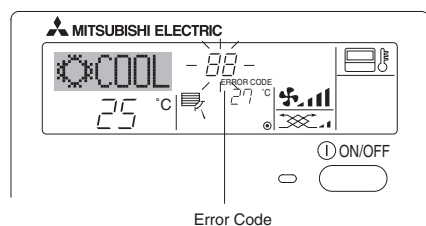

- If only the error code is blinking (while the ON lamp remains lit): Operation is continuing, but there may be a problem with the system. In this case, you should note down the error code and then call your dealer or servicer for advice.
- * If you have entered contact number to be called in the event of a problem, push the Check button to display it on the screen. (You can set this up under Function Selection of remote controller. For information, refer to section 8.)

8. Function Selection

Function selection of remote controller

The setting of the following remote controller functions can be changed using the remote controller function selection mode. Change the setting when needed.

| Item 1 | Item 2 | Item 3 (Setting content) |
|--|--|---|
| 1. Change Language ("CHANGE LANGUAGE") | Language setting to display | <ul style="list-style-type: none"> • Display in multiple languages is possible |
| 2. Function limit ("FUNCTION SELECTION") | (1) Operation function limit setting (operation lock) ("LOCKING FUNCTION") | <ul style="list-style-type: none"> • Setting the range of operation limit (operation lock) |
| | (2) Use of automatic mode setting ("SELECT AUTO MODE") | <ul style="list-style-type: none"> • Setting the use or non-use of "automatic" operation mode |
| | (3) Temperature range limit setting ("LIMIT TEMP FUNCTION") | <ul style="list-style-type: none"> • Setting the temperature adjustable range (maximum, minimum) |
| 3. Mode selection ("MODE SELECTION") | (1) Remote controller main/sub setting ("CONTROLLER MAIN/SUB") | <ul style="list-style-type: none"> • Selecting main or sub remote controller * When two remote controllers are connected to one group, one controller must be set to sub. |
| | (2) Use of clock setting ("CLOCK") | <ul style="list-style-type: none"> • Setting the use or non-use of clock function |
| | (3) Timer function setting ("WEEKLY TIMER") | <ul style="list-style-type: none"> • Setting the timer type |
| | (4) Contact number setting for error situation ("CALL.") | <ul style="list-style-type: none"> • Contact number display in case of error • Setting the telephone number |
| 4. Display change ("DISP MODE SETTING") | (1) Temperature display °C/°F setting ("TEMP MODE °C/°F") | <ul style="list-style-type: none"> • Setting the temperature unit (°C or °F) to display |
| | (2) Room air temperature display setting ("ROOM TEMP DISP SELECT") | <ul style="list-style-type: none"> • Setting the use or non-use of the display of indoor (suction) air temperature |
| | (3) Automatic cooling/heating display setting ("AUTO MODE DISP C/H") | <ul style="list-style-type: none"> • Setting the use or non-use of the display of "Cooling" or "Heating" display during operation with automatic mode |

8. Function Selection

[Function selection flowchart]
Setting language (English)

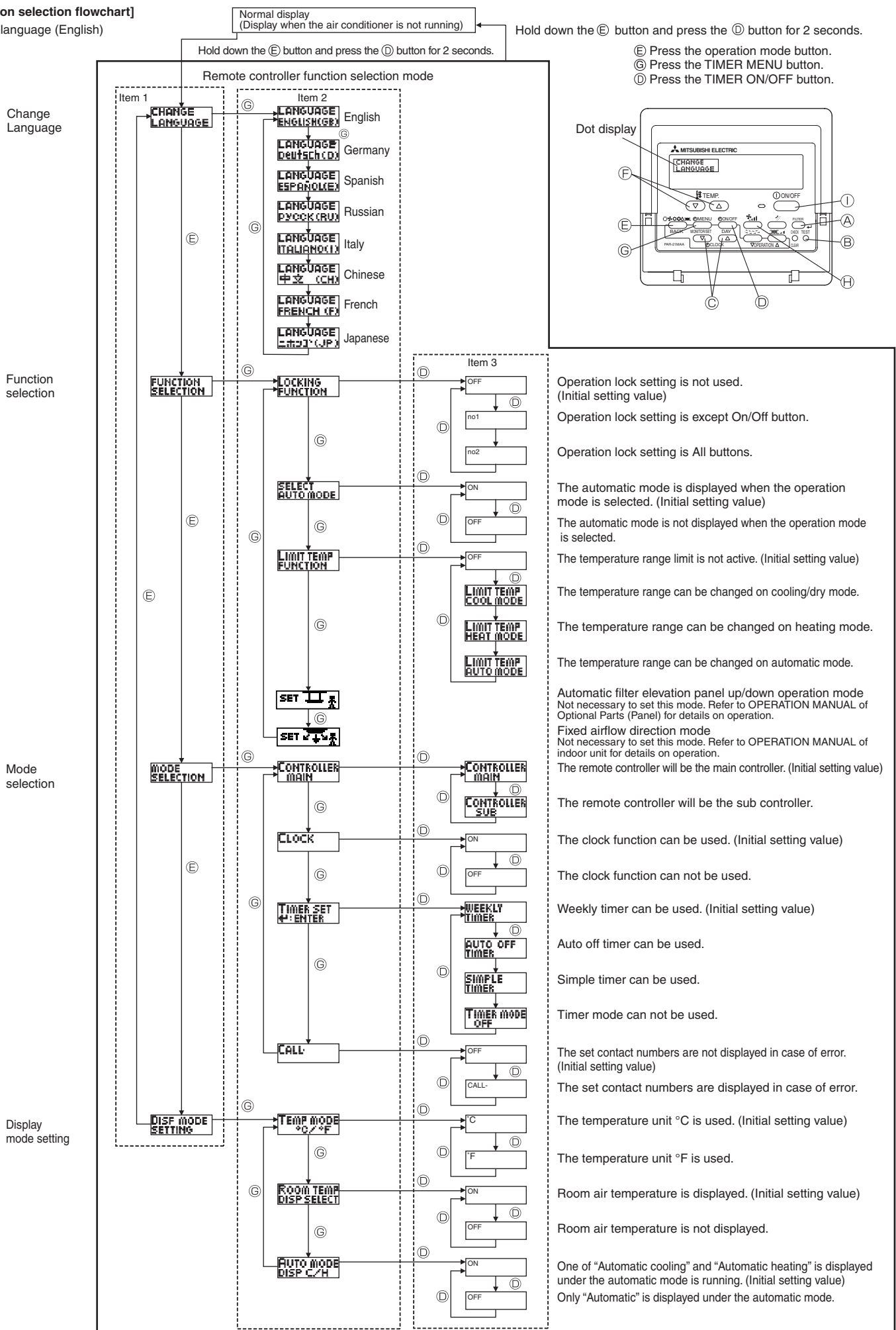

8. Function Selection

[Detailed setting]

[4]-1 CHANGE LANGUAGE setting

The language that appears on the dot display can be selected.

- Press the [⊖ MENU] button ⑥ to change the language.
 - ① English (GB), ② German (D), ③ Spanish (E), ④ Russian (RU),
 - ⑤ Italian (I), ⑥ Chinese (CH), ⑦ French (F), ⑧ Japanese (JP)

Refer to the dot display table.

[4]-2 Function limit

(1) Operation function limit setting (operation lock)

- To switch the setting, press the [⊖ ON/OFF] button ⑥.
 - ① no1: Operation lock setting is made on all buttons other than the [⊖ ON/OFF] button.
 - ② no2: Operation lock setting is made on all buttons.
 - ③ OFF (Initial setting value): Operation lock setting is not made.
- * To make the operation lock setting valid on the normal screen, it is necessary to press buttons (Press and hold down the [FILTER] and [⊖ ON/OFF] buttons at the same time for two seconds.) on the normal screen after the above setting is made.

(2) Use of automatic mode setting

When the remote controller is connected to the unit that has automatic operation mode, the following settings can be made.

- To switch the setting, press the [⊖ ON/OFF] button ⑥.
 - ① ON (Initial setting value):
The automatic mode is displayed when the operation mode is selected.
 - ② OFF:
The automatic mode is not displayed when the operation mode is selected.

(3) Temperature range limit setting

After this setting is made, the temperature can be changed within the set range.

- To switch the setting, press the [⊖ ON/OFF] button ⑥.
 - ① LIMIT TEMP COOL MODE:
The temperature range can be changed on cooling/dry mode.
 - ② LIMIT TEMP HEAT MODE:
The temperature range can be changed on heating mode.
 - ③ LIMIT TEMP AUTO MODE:
The temperature range can be changed on automatic mode.
 - ④ OFF (initial setting): The temperature range limit is not active.
- * When the setting other than OFF is made, the temperature range limit setting on cooling, heating and automatic mode is made at the same time. However, the range cannot be limited when the set temperature range has not changed.

- To increase or decrease the temperature, press the [⬇️ TEMP. (▽) or (△)] button ⑤.
- To switch the upper limit setting and the lower limit setting, press the [⚙️,all] button ④. The selected setting will blink and the temperature can be set.

- Settable range

Cooling/Dry mode:

Lower limit:19°C ~ 30°C Upper limit:30°C ~ 19°C

Heating mode:

Lower limit:17°C ~ 28°C Upper limit:28°C ~ 17°C

Automatic mode:

Lower limit:19°C ~ 28°C Upper limit:28°C ~ 19°C

[4]-3 Mode selection setting

(1) Remote controller main/sub setting

- To switch the setting, press the [⊖ ON/OFF] button ⑥.
 - ① Main: The controller will be the main controller.
 - ② Sub: The controller will be the sub controller.

(2) Use of clock setting

- To switch the setting, press the [⊖ ON/OFF] button ⑥.
 - ① ON: The clock function can be used.
 - ② OFF: The clock function cannot be used.

(3) Timer function setting

- To switch the setting, press the [⊖ ON/OFF] button ⑥ (Choose one of the followings.).
 - ① WEEKLY TIMER (initial setting value):
The weekly timer can be used.
 - ② AUTO OFF TIMER:
The auto off timer can be used.
 - ③ SIMPLE TIMER:
The simple timer can be used.
 - ④ TIMER MODE OFF:
The timer mode cannot be used.
- * When the use of clock setting is OFF, the "WEEKLY TIMER" cannot be used.

(4) Contact number setting for error situation

- To switch the setting, press the [⊖ ON/OFF] button ⑥.
 - ① CALL OFF:
The set contact numbers are not displayed in case of error.
 - ② CALL **** *
The set contact numbers are displayed in case of error.
CALL :
The contact number can be set when the display is as shown above.
- Setting the contact numbers
To set the contact numbers, follow the following procedures.
Move the blinking cursor to set numbers. Press the [⬇️ TEMP. (▽) and (△)] button ⑤ to move the cursor to the right (left).
Press the [⊖ CLOCK (▽) and (△)] button ⑥ to set the numbers.

[4]-4 Display change setting

(1) Temperature display °C/°F setting

- To switch the setting, press the [⊖ ON/OFF] button ⑥.
 - ① °C: The temperature unit °C is used.
 - ② °F: The temperature unit °F is used.

(2) Room air temperature display setting

- To switch the setting, press the [⊖ ON/OFF] button ⑥.
 - ① ON: The room air temperature is displayed.
 - ② OFF: The room air temperature is not displayed.

(3) Automatic cooling/heating display setting

- To switch the setting, press the [⊖ ON/OFF] button ⑥.
 - ① ON:
One of "Automatic cooling" and "Automatic heating" is displayed under the automatic mode is running.
 - ② OFF:
Only "Automatic" is displayed under the automatic mode.

8. Function Selection

[Dot display table]

| Selecting language | English | Germany | Spanish | Russian | Italy | Chinese | French | Japanese | |
|-------------------------|------------------------|-----------------------|----------------------|----------------------|---------------------------|--------------|------------------------|---------------|-----|
| Waiting for start-up | PLEASE WAIT | ← | ← | ← | ← | ← | ← | ← | |
| Operation mode | Cool | COOL | Kühlen | FRÍO | Холод | COOL | 制冷 | FROID | 冷房 |
| | Dry | DRY | Trocknen | DESHUMIDIFICACION | Сушка | DRY | 除湿 | DESHU | ドライ |
| | Heat | HEAT | Heizen | CALOR | Тепло | HEAT | 制热 | CHAUD | 暖房 |
| | Auto | AUTO | AUTO | AUTO-MÁTICO | АВТО | AUTO | 自动 | AUTO | 自動 |
| | Auto(Cool) | COOL | Kühlen | FRÍO | Холод | COOL | 制冷 | FROID | 冷房 |
| | Auto(Heat) | HEAT | Heizen | CALOR | Тепло | HEAT | 制热 | CHAUD | 暖房 |
| | Fan | FAN | Lüfter | VENTILACION | ВЕНТ | VENTILAZIONE | 送风 | VENTILATION | 送風 |
| | Ventilation | VENTILATION | Gebäuselüftung | VENTILACION | ВЕНТИЛЯЦИЯ | ARIA ESTERNA | 换气 | VENTILATION | 換気 |
| | Stand by (Hot adjust) | STAND BY | STAND BY | CALENTANDO | ОБОГРЕВ: ПАУЗА | STAND BY | 准备中 | PRE CHAUFFAGE | 準備中 |
| Defrost | DEFROST | Abtauen | DESCONGELACION | ОТТАИВАНИЕ | SBRINAMENTO | 除霜中 | DEGIVRAGE | 霜取中 | |
| Set temperature | SET TEMP | TEMP einstellen | TEMP. CONSIGNA | ЦЕЛЕВАЯ ТЕМПЕРАТУРА | IMPOSTAZIONE TEMPERATURA | 设定温度 | REGLAGE TEMPERATURE | 設定温度 | |
| Fan speed | FAN SPEED | Lüftergeschwindigkeit | VELOCIDAD VENTILADOR | СКОРОСТЬ ВЕНТИЛЯТОРА | VELOCITA' VENTILATORE | 风速 | VITESSE DE VENTILATION | 風速 | |
| Not use button | NOT AVAILABLE | nicht verfügbar | NO DISPONIBLE | НЕ ДОСТУПНО | NON DISPONIBILE | 无效按钮 | NON DISPONIBLE | 無効ボタン | |
| Check (Error) | CHECK | Prüfen | COMPROBAR | ПРОВЕРКА | CHECK | 检查 | CONTROLE | 点検 | |
| Test run | TEST RUN | Testbetrieb | TEST FUNCIONAMIENTO | ТЕСТОВЫЙ ЗАПУСК | TEST RUN | 试运行 | TEST | 试运行 | |
| Self check | SELF CHECK | Selbst-diagnose | AUTO REVISION | САМОДИАГНОСТИКА | SELF CHECK | 自我诊断 | AUTO CONTROLE | 自己診断 | |
| Unit function selection | FUNCTION SELECTION | Funktion auswählen | SELECCIÓN DE FUNCIÓN | ВЫБОР ФУНКЦИИ | SELEZIONE FUNZIONI | 功能选择 | SELECTION FONCTIONS | メニュー選択 | |
| Setting of ventilation | SETTING OF VENTILATION | Lüfterstufen wählen | CONFIG. VENTILACION | НАСТРОЙКА ВЕНТУСТАНА | IMPOSTAZIONE ARIA ESTERNA | 换气设定 | SELECTION VENTILATION | 換気設定 | |

| Selecting language | English | Germany | Spanish | Russian | Italy | Chinese | French | Japanese |
|---|-----------------------|----------------------------|--------------------------|---------------------------|---------------------------|-------------|-------------------------|------------------|
| CHANGE LANGUAGE | CHANGE LANGUAGE | ← | ← | ← | ← | ← | ← | ← |
| Function selection | FUNCTION SELECTION | Funktion auswählen | SELECCIÓN DE FUNCIONES | ВЫБОР ФУНКЦИИ | SELEZIONE FUNZIONI | 功能限制 | SELECTION FONCTIONS | メニュー制限 |
| Operation function limit setting | LOCKING FUNCTION | Sperre - Funktion | FUNCIÓN BLOQUEADA | ФУНКЦИЯ БЛОКИРОВКИ | BLOCCO FUNZIONI | 操作限制 | BLOCCAGE FONCTIONS | 操作モード |
| Use of automatic mode setting | SELECT AUTO MODE | Auswahl Auto Betrieb | SELECCIÓN MODO AUTO | ВЫБОР РЕЖИМА АВТО | SELEZIONE MODO AUTO | 自动模式 | SELECTION DU MODO AUTO | 自動モード |
| Temperature range limit setting | LIMIT TEMP FUNCTION | Limit Temp Funktion | LIMIT TEMP CONSIGNA | ОГРАНИЧЕННЕ УСТ.ТЕМПЕРАТ | LIMITAZIONE TEMPERATURA | 温度限制 | LIMITATION TEMPERATURE | 温度制限 |
| Limit temperature cooling/day mode | LIMIT TEMP COOL MODE | Limit Kühl Temp | LIMIT TEMP MODO FRIO | ОГРАНИЧЕНО ОХЛАЖДЕНИЕ | LIMITAZIONE MODO COOL | 制冷范围 | LIMITE TEMP MODO FROID | 制冷冷房 |
| Limit temperature heating mode | LIMIT TEMP HEAT MODE | Limit Heiz Temp | LIMIT TEMP MODO CALOR | ОГРАНИЧЕН ОБОГРЕВ | LIMITAZIONE MODO HEAT | 制热范围 | LIMITE TEMP MODO CHAUD | 制热暖房 |
| Limit temperature auto mode | LIMIT TEMP AUTO MODE | Limit Auto Temp | LIMIT TEMP MODO AUTO | ОГРАНИЧЕН РЕЖИМ АВТО | LIMITAZIONE MODO AUTO | 自动范围 | LIMITE TEMP MODO AUTO | 制热自动 |
| Mode selection | MODE SELECTION | Betriebsart wählen | SELECCIÓN DE MODO | ВЫБОР РЕЖИМА | SELEZIONE MODO | 基本模式 | SELECTION DU MODO | 基本メニュー |
| Remote controller setting MAIN | CONTROLLER MAIN | Haupt Controller | CONTROL PRINCIPAL | ОСНОВНОЙ ПУЛЬТ | CONTROLLO MAIN | 遥控主 | TELCOMMANDE MAITRE | 遥控器主 |
| Remote controller setting SUB | CONTROLLER SUB | Neben Controller | CONTROL SECUNDARIO | ДОПОЛНИТЕЛЬНЫЙ ПУЛЬТ | CONTROLLO SUB | 遥控辅 | TELCOMMANDE ESCLAVE | 遥控器主副 |
| Use of clock setting | CLOCK | Uhr | RELOJ | ЧАСЫ | OROLOGIO | 时钟 | AFFICHAGE HORLOGE | 時計 3000 |
| Setting the day of the week and time | TIME SET +:ENTER | Uhr stellen +:einstellen | CONFIG RELOJ +:CONFIG | ЧАСЫ:УСТ. +:ВВОД | OROLOGIO +:ENTER | 时间 +:ENTER | HORLOGE +:ENTRER | トクイセッテイ +: カクタイ |
| Timer set | TIMER SET +:ENTER | Zeitschaltuhr +:einstellen | TEMPORIZA - DOR +:CONFIG | ТАЙМЕР:УСТ. +:ВВОД | TIMER +:ENTER | 定时器 +:ENTER | PROG HORAIRE +:ENTRER | タイマーセッテイ +: カクタイ |
| Timer monitor | TIMER MONITOR | Uhrzeit Anzeige | VISUALIZAR TEMPORIZAD. | ПРОСМОТР ТАЙМЕРА | VISUALIZ TIMER | 定时器状态 | AFFICHAGE PROG HORAIRE | タイマーモニター |
| Weekly timer | WEEKLY TIMER | Wochenzeit schalt Uhr | TEMPORIZA - DOR SEMANAL | НЕДЕЛЬНЫЙ ТАЙМЕР | TIMER SETTIMANALE | 每周定时器 | PROG HEBDO MADAIRE | タイマー週間 |
| Timer mode off | TIMER MODE OFF | Zeitschaltuhr AUS | TEMPORIZA - DOR APAGADO | ТАЙМЕР ВЫКЛ. | TIMER OFF | 定时器无效 | PROG HORAIRE INACTIF | タイマー無効 |
| Auto off timer | AUTO OFF TIMER | Auto Zeit funktion AUS | APAGADO AUTOMÁTICO | ДЕТОНТИРОВАНИЕ ПО ТАЙМЕРУ | AUTO OFF TIMER | 解除定时 | PROG HORAIRE ARRET AUTO | タイマーキャンセルホウジ |
| Simple timer | SIMPLE TIMER | Einfache Zeitfunktion | TEMPORIZA - DOR SIMPLE | ПРОСТОЙ ТАЙМЕР | TIMER SEMPLIFICATO | 简易定时器 | PROG HORAIRE SIMPLIFIE | タイマーカンイ |
| Contact number setting of error situation | CALL | ← | ← | ← | ← | ← | ← | ← |
| Display change | DISP MODE SETTING | Anzeige Betriebsart | MOSTRAR MODO | НАСТРОЙКА НАД РЕЖИМ | IMPOSTAZIONE MODO DISPLAY | 转换表示 | AFFICHAGE SOUS MENU | 表示切替 |
| Temperature display °C/°F setting | TEMP MODE °C/°F | Wechsel °C/°F | TEMP GRADOS °C/°F | ЕДИН.ТЕМП. °C/°F | TEMPERATURA °C/°F | 温度 °C/°F | TEMPERATURE °C/°F | 温度 °C/°F |
| Room air temperature display setting | ROOM TEMP DISP SELECT | Raum Temp gewährit | MOSTRAR TEMP | ПОКАЗЫВАТЬ ТЕМП.В КОМН. | TEMPERATURA AMBIENTE | 吸入温度 | TEMPERATURE AMBIANTE | スィコホド 3000 |
| Automatic cooling/heating display setting | AUTO MODE DISP C/H | Auto Betrieb C/H | MOSTRAR F/C EN AUTO | НАД.Т/Х В РЕЖИМЕ АВТО | AUTO C/H | 自动表示 | AFFICHAGE AUTO F/C | 自動表示 3000 |

9. Emergency Operation for Wireless Remote-controller

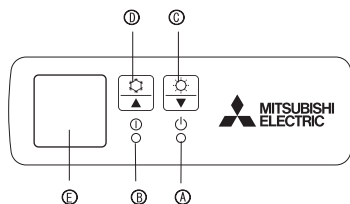

When the remote controller cannot be used

When the batteries of the remote controller run out or the remote controller malfunctions, the emergency operation can be done using the emergency buttons on the grille.

- Ⓐ DEFROST/STAND BY lamp
- Ⓑ Operation lamp
- Ⓒ Emergency operation switch (heating)
- Ⓓ Emergency operation switch (cooling)
- Ⓔ Receiver

Starting operation

- To operate the cooling mode, press the Ⓓ button for more than 2 seconds.
- To operate the heating mode, press the Ⓒ button for more than 2 seconds.

* Lighting of the Operation lamp Ⓑ means the start of operation.

Note:

- Details of emergency mode are as shown below.

Details of EMERGENCY MODE are as shown below.

| Operation mode | COOL | HEAT |
|-------------------|------------|------------|
| Set temperature | 24°C | 24°C |
| Fan speed | High | High |
| Airflow direction | Horizontal | Downward 5 |

Stopping operation

- To stop operation, press the Ⓓ button or the Ⓒ button.

10. Care and Cleaning

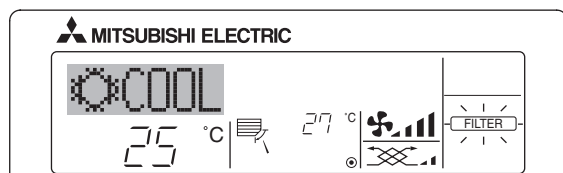

- Indicates that the filter needs cleaning.

Ask authorized people to clean the filter.

- When resetting "FILTER" display

When the [FILTER] button is pressed two times successively after cleaning the filter, the display goes off and is reset.

Note:

- When two or more different types of indoor unit are controlled, the cleaning period differs with the type of filter. When the master unit cleaning period arrives, "FILTER" is displayed. When the filter display goes off, the cumulative time is reset.
- "FILTER" indicates the cleaning period when the air conditioner was used under general indoor air conditions by criteria time. Since the degree of dirtiness depends on the environmental conditions, clean the filter accordingly.
- The filter cleaning period cumulative time differs with the model.
- This indication is not available for wireless remote controller.

▶ Cleaning the filters

- Clean the filters using a vacuum cleaner. If you do not have a vacuum cleaner, tap the filters against a solid object to knock off dirt and dust.
- If the filters are especially dirty, wash them in lukewarm water. Take care to rinse off any detergent thoroughly and allow the filters to dry completely before putting them back into the unit.

⚠ Caution:

- Do not dry the filters in direct sunlight or by using a heat source, such as an electric heater: this may warp them.
- Do not wash the filters in hot water (above 50°C), as this may warp them.
- Make sure that the air filters are always installed. Operating the unit without air filters can cause malfunction.

⚠ Caution:

- Before you start cleaning, stop operation and turn OFF the power supply.
- Indoor units are equipped with filters to remove the dust of sucked-in air. Clean the filters using the methods shown in the following sketches.

▶ Filter removal

⚠ Caution:



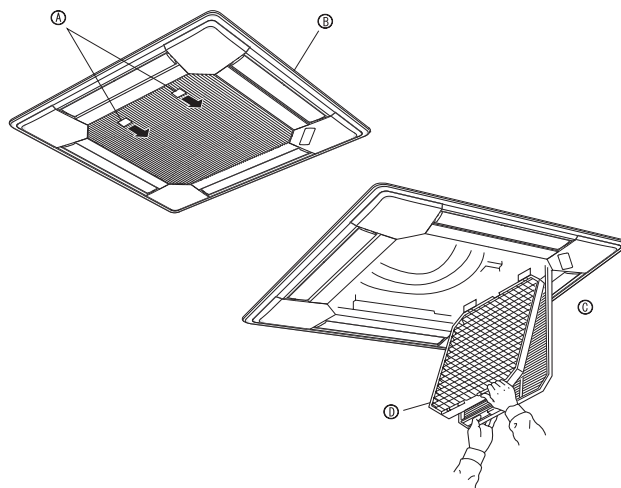

- In removing the filter, precautions must be taken to protect your eyes from dust. Also, if you have to climb up on a stool to do the job, be careful not to fall.
- When the filter is removed, do not touch the metallic parts inside the indoor unit, otherwise injury may result.

■ PLA-RP-BA



- ① Pull the knob on the intake grille in the direction indicated by the arrow and it should open.
 - ② Open the intake grille.
 - ③ Release the knob on the center edge of the intake grille and pull the filter forward to remove the filter.
- Ⓐ Knob Ⓑ Grille Ⓒ Intake grille Ⓓ Filter

11. Trouble Shooting

| Having trouble? | Here is the solution. (Unit is operating normally.) |
|---|---|
| Air conditioner does not heat or cool well. | <ul style="list-style-type: none"> ■ Clean the filter. (Airflow is reduced when the filter is dirty or clogged.) ■ Check the temperature adjustment and adjust the set temperature. ■ Make sure that there is plenty of space around the outdoor unit. Is the indoor unit air intake or outlet blocked? ■ Has a door or window been left open? |
| When heating operation starts, warm air does not blow from the indoor unit soon. | <ul style="list-style-type: none"> ■ Warm air does not blow until the indoor unit has sufficiently warmed up. |
| During heating mode, the air conditioner stops before the set room temperature is reached. | <ul style="list-style-type: none"> ■ When the outdoor temperature is low and the humidity is high, frost may form on the outdoor unit. If this occurs, the outdoor unit performs a defrosting operation. Normal operation should begin after approximately 10 minutes. |
| Airflow direction changes during operation or airflow direction cannot be set. | <ul style="list-style-type: none"> ■ During cooling mode, the vanes automatically move to the horizontal (down) position after 1 hour when the down (horizontal) airflow direction is selected. This is to prevent water from forming and dripping from the vanes. ■ During heating mode, the vanes automatically move to the horizontal airflow direction when the airflow temperature is low or during defrosting mode. |
| When the airflow direction is changed, the vanes always move up and down past the set position before finally stopping at the position. | <ul style="list-style-type: none"> ■ When the airflow direction is changed, the vanes move to the set position after detecting the base position. |
| A flowing water sound or occasional hissing sound is heard. | <ul style="list-style-type: none"> ■ These sounds can be heard when refrigerant is flowing in the air conditioner or when the refrigerant flow is changing. |
| A cracking or creaking sound is heard. | <ul style="list-style-type: none"> ■ These sounds can be heard when parts rub against each due to expansion and contraction from temperature changes. |
| The room has an unpleasant odor. | <ul style="list-style-type: none"> ■ The indoor unit draws in air that contains gases produced from the walls, carpeting, and furniture as well as odors trapped in clothing, and then blows this air back into the room. |
| A white mist or vapor is emitted from the indoor unit. | <ul style="list-style-type: none"> ■ If the indoor temperature and the humidity are high, this condition may occur when operation starts. ■ During defrosting mode, cool airflow may blow down and appear like a mist. |
| Water or vapor is emitted from the outdoor unit. | <ul style="list-style-type: none"> ■ During cooling mode, water may form and drip from the cool pipes and joints. ■ During heating mode, water may form and drip from the heat exchanger. ■ During defrosting mode, water on the heat exchanger evaporates and water vapor may be emitted. |
| The operation indicator does not appear in the remote controller display. | <ul style="list-style-type: none"> ■ Turn on the power switch. "●" will appear in the remote controller display. |
| "  appears in the remote controller display. | <ul style="list-style-type: none"> ■ During central control, "" appears in the remote controller display and air conditioner operation cannot be started or stopped using the remote controller. |
| When restarting the air conditioner soon after stopping it, it does not operate even though the ON/OFF button is pressed. | <ul style="list-style-type: none"> ■ Wait approximately three minutes. (Operation has stopped to protect the air conditioner.) |
| Air conditioner operates without the ON/OFF button being pressed. | <ul style="list-style-type: none"> ■ Is the on timer set? Press the ON/OFF button to stop operation. ■ Is the air conditioner connected to a central remote controller? Consult the concerned people who control the air conditioner. ■ Does " appear in the remote controller display? Consult the concerned people who control the air conditioner. ■ Has the auto recovery feature from power failures been set? Press the ON/OFF button to stop operation. |
| Air conditioner stops without the ON/OFF button being pressed. | <ul style="list-style-type: none"> ■ Is the off timer set? Press the ON/OFF button to restart operation. ■ Is the air conditioner connected to a central remote controller? Consult the concerned people who control the air conditioner. ■ Does " appear in the remote controller display? Consult the concerned people who control the air conditioner. |
| Remote controller timer operation cannot be set. | <ul style="list-style-type: none"> ■ Are timer settings invalid? If the timer can be set, WEEKLY , SIMPLE , or AUTO OFF appears in the remote controller display. |
| "PLEASE WAIT" appears in the remote controller display. | <ul style="list-style-type: none"> ■ The initial settings are being performed. Wait approximately 3 minutes. |
| An error code appears in the remote controller display. | <ul style="list-style-type: none"> ■ The protection devices have operated to protect the air conditioner. ■ Do not attempt to repair this equipment by yourself. Turn off the power switch immediately and consult your dealer. Be sure to provide the dealer with the model name and information that appeared in the remote controller display. |
| Draining water or motor rotation sound is heard. | <ul style="list-style-type: none"> ■ When cooling operation stops, the drain pump operates and then stops. Wait approximately 3 minutes. |

11. Trouble Shooting

| Having trouble? | Here is the solution. (Unit is operating normally.) | | | | | | | | | | | | |
|--|---|-----------------------------------|----------------------------|--------------|---------------------------|-------------------|---------------------------------------|-----------------------------------|--------------------|--------------|-----------|------------|------------|
| Noise is louder than specifications. | <p>■ The indoor operation sound level is affected by the acoustics of the particular room as shown in the following table and will be higher than the noise specification, which was measured in anechoic room.</p> <table border="1"> <thead> <tr> <th></th> <th>High sound absorbing rooms</th> <th>Normal rooms</th> <th>Low sound absorbing rooms</th> </tr> </thead> <tbody> <tr> <td>Location examples</td> <td>Broadcasting studio, music room, etc.</td> <td>Reception room, hotel lobby, etc.</td> <td>Office, hotel room</td> </tr> <tr> <td>Noise levels</td> <td>3 to 7 dB</td> <td>6 to 10 dB</td> <td>9 to 13 dB</td> </tr> </tbody> </table> | | High sound absorbing rooms | Normal rooms | Low sound absorbing rooms | Location examples | Broadcasting studio, music room, etc. | Reception room, hotel lobby, etc. | Office, hotel room | Noise levels | 3 to 7 dB | 6 to 10 dB | 9 to 13 dB |
| | High sound absorbing rooms | Normal rooms | Low sound absorbing rooms | | | | | | | | | | |
| Location examples | Broadcasting studio, music room, etc. | Reception room, hotel lobby, etc. | Office, hotel room | | | | | | | | | | |
| Noise levels | 3 to 7 dB | 6 to 10 dB | 9 to 13 dB | | | | | | | | | | |
| Nothing appears in the wireless remote controller display, the display is faint, or signals are not received by the indoor unit unless the remote controller is close. | <p>■ The batteries are low. Replace the batteries and press the Reset button.</p> <p>■ If nothing appears even after the batteries are replaced, make sure that the batteries are installed in the correct directions (+, -).</p> | | | | | | | | | | | | |
| The operation lamp near the receiver for the wireless remote controller on the indoor unit is blinking. | <p>■ The self diagnosis function has operated to protect the air conditioner.</p> <p>■ Do not attempt to repair this equipment by yourself. Turn off the power switch immediately and consult your dealer. Be sure to provide the dealer with the model name.</p> | | | | | | | | | | | | |

12. Specifications

| Model | PLA-RP35BA | PLA-RP50BA | PLA-RP60BA | PLA-RP71BA | PLA-RP100BA | PLA-RP125BA | PLA-RP140BA |
|--|-------------|-------------|-------------|-------------|-------------|-------------|-------------|
| Power source(voltage <V>/Frequency<Hz>) | ~/N 230/50 | | | | | | |
| Rated Input(Indoor Only) <kW> | 0.03 | 0.05 | 0.05 | 0.07 | 0.14 | 0.15 | 0.16 |
| Rated Current(Indoor only) <A> | 0.22 | 0.36 | 0.36 | 0.51 | 0.94 | 1.00 | 1.07 |
| HEATER <kW> | - | - | - | - | - | - | - |
| Dimension(Height) <mm> | 258(35) | | | 298(35) | | | |
| Dimension(Width) <mm> | 840(950) | | | | | | |
| Dimension(Depth) <mm> | 840(950) | | | | | | |
| Fan airflow rate(Low-Middle2-Middle1-High) <m ³ /min> | 11-12-13-15 | 12-14-16-18 | 12-14-16-18 | 14-16-18-21 | 20-23-26-30 | 22-25-28-31 | 24-26-29-32 |
| Noise level(Low -Middle2-Middle1-High) <dB> | 27-28-29-31 | 28-29-31-32 | 28-29-31-32 | 28-30-32-34 | 32-34-37-40 | 34-36-39-41 | 36-39-42-44 |
| Net weight <kg> | 22(6) | | 23(6) | | 25(6) | | 27(6) |

*1 The figure in () indicates GRILL`s.

This product is designed and intended for use in the residential,
commercial and light-industrial environment.

The product at hand is
based on the following
EU regulations:

- Low Voltage Directive 2006/95/EC
- Electromagnetic Compatibility Directive 89/
336/ EEC

Please be sure to put the contact address/telephone number on
this manual before handing it to the customer.