

CD Radio Cassette Recorder

AZ 1145

AZ 1146

AZ 1147

AZ 1148



Let's make things better.



PHILIPS

Important notes for users in the U.K.

Mains plug

This apparatus is fitted with an approved moulded 13 Amp plug. To change a fuse in this type of plug proceed as follows:

- Remove fuse cover and fuse.
- Fix new fuse which should be a BS1362 5 Amp, A.S.T.A. or BSI approved type.
- Refit the fuse cover.

If the fitted plug is not suitable for your socket outlets, it should be cut off and an appropriate plug fitted in its place.

If the mains plug contains a fuse, this should have a value of 5 Amp. If a plug without a fuse is used, the fuse at the distribution board should not be greater than 5 Amp.

Note: The severed plug must be disposed to avoid a possible shock hazard should it be inserted into a 13 Amp socket elsewhere.

How to connect a plug

The wires in the mains lead are coloured with the following code: blue = neutral (N), brown = live (L). As these colours may not correspond with the colour markings identifying the terminals in your plug, proceed as follows:

- Connect the blue wire to the terminal marked N or coloured black.
- Connect the brown wire to the terminal marked L or coloured red.
- Do not connect either wire to the earth terminal in the plug, marked E (or $\frac{1}{2}$) or coloured green (or green and yellow).

Before replacing the plug cover, make certain that the cord grip is clamped over the sheath of the lead - not simply over the two wires. Copyright in the U.K.: Recording and playback of material may require consent. See Copyright Act 1956 and The Performer's Protection Acts 1958 to 1972.

N Norge

Advarsel: For å redusere faren for brann eller elektrisk støt; skal apparatet ikke utsettes for regn eller fuktighet.

Typeskilt finnes på apparatens underside.

Observer: Nettbryteren er sekundert innkopleet. Den innebygde nettdelen er derfor ikke frakopleet nettet så lenge apparatet er tilsluttet nettkontakten

I Italia

DICHIARAZIONE DI CONFORMITA'

Si dichiara che l'apparecchio AZ 1145 Philips risponde alle prescrizioni dell'art. 2 comma 1 del D. M. 28 Agosto 1995 n. 548.

Philips Consumer Electronics
Philips, Glaslaan 2,
5616 JB Eindhoven, The Netherlands

English 4

English

Français 14

Français

Español 24

Español

Deutsch 34

Deutsch

Nederlands 44

Nederlands

Italiano 54

Italiano

Português 64

Português

Dansk 74

Dansk

Svenska 84

Svenska

Suomi 94

Suomi

Ελληνικά 104

Ελληνικά

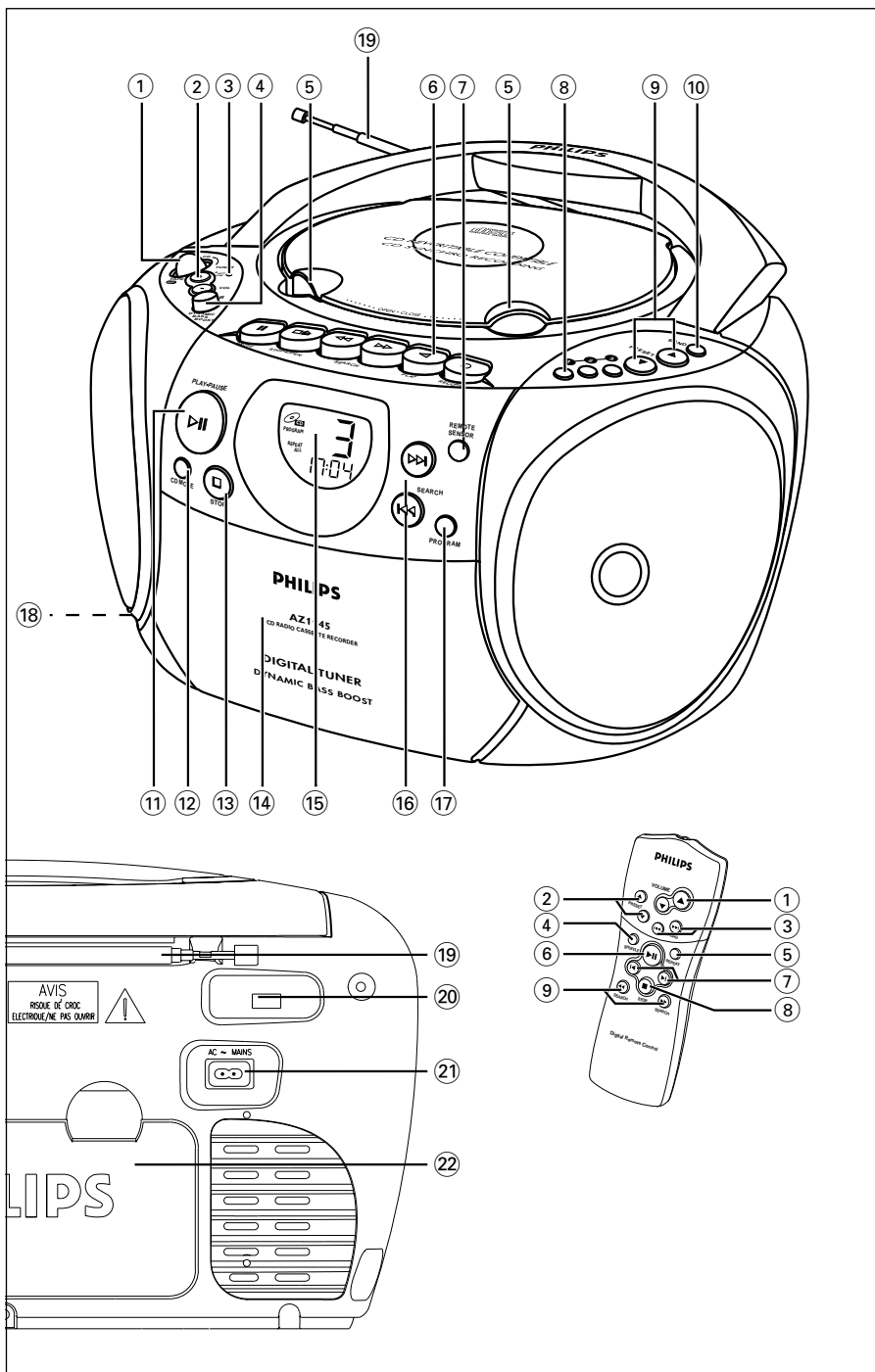

CONTROLS

TOP AND FRONT PANELS

- ① **POWER slider** - selects the sound source for CD/ TUNER/ TAPE OFF and also switches the set off
- ② **VOL +, -** - adjusts the volume level
- ③ **BATT LOW** - indicates when battery power is running low
- ④ **DBB (Dynamic Bass Boost)** - enhances the bass
- ⑤ **OPEN • CLOSE** - opens/ closes the CD door
- ⑥ **CASSETTE RECORDER keys**
 - RECORD ●** - starts recording
 - PLAY ◀** - starts playback
 - SEARCH ◀◀/▶▶** - fast winds/rewinds the tape
 - STOP • OPEN ■▲** - stops the tape;
- opens the cassette compartment
 - PAUSE ■■** - interrupts recording or playback
- ⑦ **REMOTE SENSOR** - infrared sensor for the remote control
- ⑧ **1-3** - programmes and selects your favourite three radio stations
- ⑨ **PRESET ▲, ▼** - (down, up) selects preset tuner stations
- ⑩ **BAND** - selects waveband
- ⑪ **PLAY PAUSE ▶■** - starts /pauses CD playback
- ⑫ **CD MODE** - selects a different play mode e.g. SHUFFLE/ REPEAT CD tracks or programme in random /repeated order
- ⑬ **STOP ■** - stops CD playback or erase a CD programme;
activates/ deactivates display demo mode.
- ⑭ **Cassette door**
- ⑮ **Display** - shows the status of the set

- ⑮ **SEARCH ◀◀/▶▶**
 - Tuner:** (down, up) tunes radio stations.
 - CD:** - searches back and forward within a track;
- skips to the beginning of a current track/ previous/ later track
- ⑯ **PROGRAM -**
 - Tuner** - programmes preset radio stations;
 - CD** - programmes tracks and reviews the programme

BACK PANEL

- ⑱ **🎧** - 3.5 mm stereo headphone socket
- ⑲ **Telescopic antenna** - improves FM reception
- ⑳ **BEAT CUT switch** - eliminates possible whistle tones during MW/LW recordings
- ㉑ **AC MAINS** - inlet for power cord
- ㉒ **Battery compartment** - for six batteries, type **R-14, UM-2** or **C-cells**

REMOTE CONTROL

- ① **VOLUME ▲, ▼** – adjusts volume level
- ② **PRESET ▲, ▼** (up, down) – selects a preset radio station
- ③ **TUNING ◀◀, ▶▶** (down, up) – tunes to radio stations
- ④ **SHUFFLE** – to play CD tracks in random order
- ⑤ **REPEAT** – repeats a track/ CD programme/ entire CD
- ⑥ **▶■** – starts and pauses CD playback/ interrupts CD playback
- ⑦ **◀, ▶** – skips to the beginning of a current track/ previous/ later track
- ⑧ **STOP ■** – stops CD playback or erases a CD programme
- ⑨ **SEARCH ◀◀, ▶▶** – searches backwards or forwards within a track/CD

CAUTION

Use of controls or adjustments or performance of procedures other than herein may result in hazardous radiation exposure or other unsafe operation.

Whenever convenient, use the mains supply if you want to conserve battery life. Make sure you remove the plug from the set and wall socket before inserting batteries.

BATTERIES (OPTIONAL)

1. Open the battery compartment and insert six batteries, type **R-14**, **UM-2** or **C-cells**, (preferably alkaline) with the correct polarity as indicated by the "+" and "-" symbols inside the compartment.

Remote control (supplied)

Open the battery compartment and insert two batteries, type **AAA**, **R03** or **UM4** (preferably alkaline).

2. Replace the compartment door, making sure the batteries are firmly and correctly in place. The set is now ready to operate.
 – If **BATT LOW** lights up, battery power is running low.
 – The **BATT LOW** indicator eventually goes out if the batteries are too weak.

Incorrect use of batteries can cause electrolyte leakage and will corrode the compartment or cause the batteries to burst.

Therefore:

- *Do not mix battery types:* e.g. alkaline with carbon zinc. Only use batteries of the same type for the set.
- When inserting new batteries, do not try to mix old batteries with the new ones.
- Remove the batteries if the set is not to be used for a long time.
- **Batteries contain chemical substances, so they should be disposed of properly.**

For users in the U.K.: please follow the instructions on page 2.

Using AC MAINS

1. Check if the mains voltage **as shown on the type plate on the base of the set**, corresponds to your local mains supply. If it does not, consult your dealer or service centre.
2. If your set is equipped with a voltage selector, adjust the selector so that it matches with the local mains supply.
3. Connect the mains lead to the wall socket and the set is now ready for use.
4. To disconnect the set from the mains supply completely, remove the plug from the wall socket.

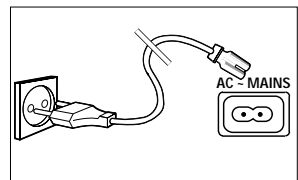
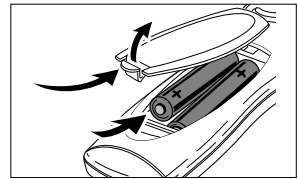
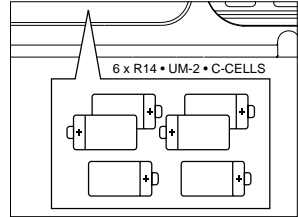

Switching on and off

- Adjust the **POWER** slider to the desired sound source: **CD**, **TUNER** or **TAPE/off**.
 - The set is switched off when the **POWER** slider is in the **TAPE/OFF** position and the keys on the tape deck are released.
- The volume and tuner presets will be retained in the set's memory.



Adjusting volume and sound

1. Press the **VOL +, -** controls to increase or decrease volume (or press **▲** or **▼** on the remote control).
2. Adjust the **DBB** control to select dynamic bass boost on or off.

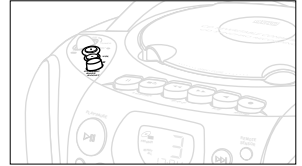

PHILIPS demo mode

1. On the set, press the **CD STOP** **■** button for 5 seconds.
→ **PH..IL ..IPS** scrolls across the display continuously.
2. To return to the current display you can either:
 - press any function button on the front panel. This interrupts the demo mode for 30 seconds;
 - press the **CD STOP** **■** button for 5 seconds. **PH..IL ..IPS** scrolls once before the demo mode is cancelled.

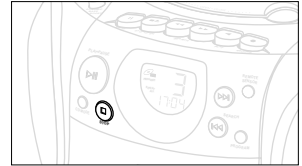

GENERAL INFORMATION

General maintenance

- Do not expose the set, batteries, CDs or cassettes to humidity, rain, sand or excessive heat caused by heating equipment or direct sunlight.
- To clean the set, use a soft, slightly dampened chamois leather. Do not use any cleaning agents containing alcohol, ammonia, benzene or abrasives as these may harm the housing.



Safety information

- Place the set on a hard and flat surface so that the system does not tilt. Make sure there is adequate ventilation to prevent the system from overheating.
- The mechanical parts of the set contain self-lubricating bearings and must not be oiled or lubricated.

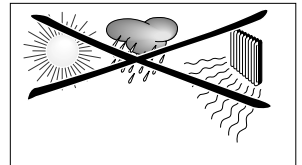

TUNING TO RADIO STATIONS

1. Select **TUNER** source.
→ **FM** is displayed briefly and then the radio station frequency is shown.
2. Press **BAND** once or more to select your waveband.
3. Press **◀** or **▶** on the set or on the remote control and release when the frequency in the display starts running.
→ The tuner automatically tunes to a station of sufficient reception. Display shows **Search** during automatic tuning.
→ If a FM station is received in stereo, **STEREO** is shown.
4. Repeat **step 3** if necessary until you find the desired station.
 - To tune to a weak station, press **◀** or **▶** briefly and repeatedly until you have found optimal reception.
5. Adjust the power slider to **TAPE/OFF** position to switch off the set.

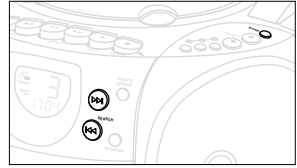

To improve radio reception

- For **FM**, pull out the telescopic aerial. Incline and turn the aerial. Reduce its length if the signal is too strong (very close to a transmitter).
- For **MW/LW**, the set is provided with a built-in aerial so the telescopic aerial is not needed. Direct the aerial by turning the whole set.

Favourite station selection

For your favourite 3 tuner stations, you can use the easy one-touch programming and selection **1**, **2** or **3** buttons.

1. Tune to your desired station (see **Tuning to radio stations**).
2. To store your station, press **1**, **2** or **3** for 2 seconds or more.
→ Display: shows **PROGRAM** briefly, your favourite preset station number and the tuner frequency.

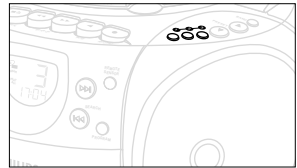

Programming radio stations

You can store up to a total of 30 radio stations in the memory.

1. Tune to your desired station (see **Tuning to radio stations**).
2. Press **PROGRAM** to activate programming.
– Display: **PROGRAM** flashes.
3. Press **PRESET ▼** or **▲** once or more to allocate a number from 1 to 30 to this station.
4. Press **PROGRAM** again to confirm the setting.
– Display: **PROGRAM** disappears, the preset number and the frequency of the preset station are shown.
5. Repeat the above four steps to store other stations.
– You can overwrite a preset station by storing another frequency in its place.

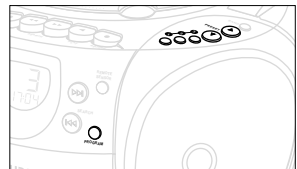

Tuning to preset stations

Press **1**, **2**, **3** or **PRESET ▼** or **▲** until the desired preset station is displayed.

CD PLAYER

Playing a CD

1. Select **CD** source.

→  is displayed briefly.

2. Lift the CD door open.

→ Display:  when you open the CD door.

3. Insert a CD or CD-R(W) with the printed side facing up and close the CD door.

→ Display:  flashes as the CD player scans the contents of a CD. The total number of tracks and playing time are then shown.

Display:  is shown if the CD-R(W) is blank or not finalised.

4. Press **PLAY•PAUSE ►||** (on the remote control ►||) to start playback.

→ Display: Current track number and elapsed playing time of the track during CD playback.

5. To pause playback press **PLAY•PAUSE ►||**.

Press **PLAY•PAUSE ►||** again to resume play.

→ The display freezes and the elapsed playing time flashes when playback is paused.

6. To stop CD playback, press **STOP ■**.

Note: CD play will also stop when:

- the CD door is opened;
- the CD has reached the end
(unless you have selected **REPEAT** or **REPEAT ALL**);
- you select another source: **TAPE / TUNER**.

Selecting a different track

• Press **SEARCH ◀◀** or **▶▶** (on the remote control ◀◀ or ▶▶) once or repeatedly until the desired track number appears in the display.

• If you have selected a track number shortly after loading a CD or in the PAUSE position, you will need to press **PLAY•PAUSE ►||** to start playback.

Finding a passage within a track

1. Press and hold down **SEARCH ◀◀** or **▶▶** (on the remote control ◀◀ or ▶▶).

→ The CD is played at high speed and low volume.

2. When you recognize the passage you want, release **SEARCH ◀◀** or **▶▶**.

– Normal playback continues.

Note: During a CD programme or if **SHUFFLE/ REPEAT** active, searching is only possible within a track.

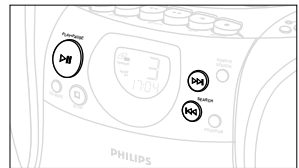
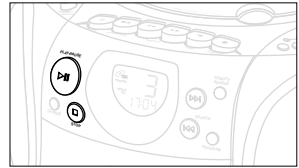
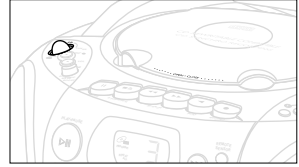

Different play modes: SHUFFLE and REPEAT

You can select and change the various play modes before or during playback. The play modes can also be combined with PROGRAM.

SHUFFLE - tracks of the entire CD/ programme are played in random order

SHUFFLE and REPEAT ALL - to repeat the entire CD/ programme continuously in random order

REPEAT ALL - to repeat the entire CD/ programme

REPEAT - to play the current track continuously

1. To select your play mode, press the **CD MODE** key (or **SHUFFLE** or **REPEAT** on the remote control) before or during playback until the display shows the desired function.
2. Press **PLAY•PAUSE** ►|| (on the remote control ►||) to start playback if in the STOP position.
3. To return to normal playback, press the **CD MODE** key or the respective **SHUFFLE** or **REPEAT** key until the various SHUFFLE / REPEAT modes are no longer displayed.
– You can also press **STOP** ■ to cancel your play mode.

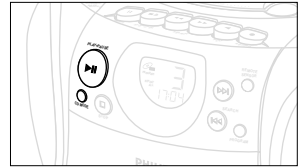

Programming track numbers

Programme in the STOP position to select and store your CD tracks in the desired sequence. If you like, store any track more than once. Up to 20 tracks can be stored in the memory.

1. Use the **SEARCH** ◀◀ or ▶▶ on the set (on the remote control ◀ or ▶) to select your desired track number.
2. Press **PROGRAM**.
→ Display: **PROGRAM** and the selected track number. P r o g appears briefly.
→ If you attempt to programme without first selecting a track number, **SEL** is shown.
3. Repeat steps 1-2 to select and store all desired tracks.
→ **FULL** is displayed if you attempt to programme more than 20 tracks.
4. To start playback of your CD programme, press **PLAY•PAUSE** ►||.

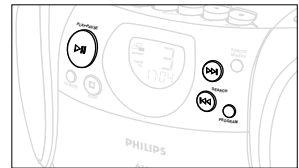

Reviewing the programme

In the STOP position, press and hold down **PROGRAM** for a while until the display shows all your stored track numbers in sequence.

Erasing a programme

You can erase the programme by:

- pressing **STOP** ■ once in the STOP position or twice during playback. The display shows ' **NO prog** ' briefly.
- pressing the CD door open;
- switching to TUNER/TAPE source.

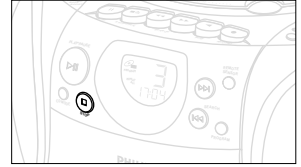

CD player and CD handling

- If the CD player cannot read CDs correctly, use a commonly available cleaning CD to clean the lens before taking the set to repair. Other cleaning methods may destroy the lens.
- The lens of the CD player should *never be touched!*
- Sudden changes in the surrounding temperature can cause condensation to cloud over on the lens of your CD player. Playing a CD is then not possible. Do not attempt to clean the lens but leave the set in a warm environment until the moisture evaporates.
- Always keep the CD compartment closed to avoid dust on the lens.
- To take a CD out of its box, press the centre spindle while lifting the CD. Always pick up the CD by the edge and return the CD to its box after use to avoid scratching and dust.
- To clean the CD, wipe in a straight line from the centre towards the edge using a soft, lint-free cloth. Do not use cleaning agents as they may damage the disc.
- *Never* write on a CD or attach any stickers to it.

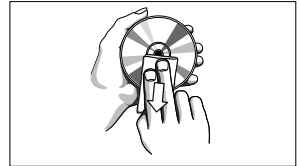
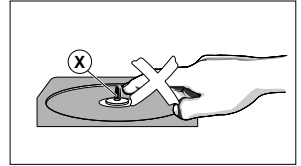

PLAYING A CASSETTE

1. Select **TAPE** source.
→ The display shows **TAPE** throughout tape operation.
2. Press **STOP•OPEN** ■▲ to open the cassette door.
3. Insert a recorded cassette and close the cassette door.
4. Press **PLAY** ◀ to start playback.
5. To interrupt playback, press **PAUSE** ■. To resume, press the key again.
6. By pressing **SEARCH** ◀◀ or ▶▶ on the set, fast winding of the tape is possible in both directions.
7. To stop the tape, press **STOP•OPEN** ■▲.
 - *The keys are automatically released at the end of the tape and the TAPE indication goes out, except if PAUSE ■ has been activated.*

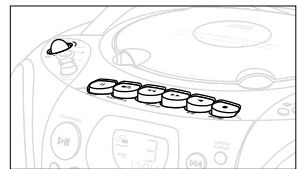

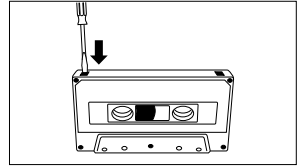

GENERAL INFORMATION ON RECORDING

- Recording is permissible insofar as copyright or other rights of third parties are not infringed.
- This deck is not suitable for recording on CHROME (IEC II) or METAL (IEC IV) type cassettes. For recording, use NORMAL type cassettes (IEC I) on which the tabs have not been broken.
- *The best recording level is set automatically.* Altering the **VOL** and **DBB** controls will not affect the recording in progress.
- At the very beginning and end of the tape, no recording will take place during the 7 seconds, when the leader tape passes the recorder heads.
- To protect a tape from accidental erasure, have the tape in front of you and break out the left tab.
Recording on this side is no longer possible. To record over this side again, cover the tabs with a piece of adhesive tape.







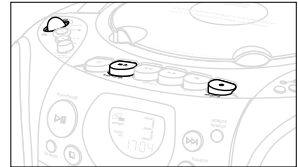





SYNCHRO START CD RECORDING

1. Select **CD** source.
2. Insert a CD and if desired, programme track numbers.
3. Press **STOP•OPEN**  to open the cassette door.
4. Insert a suitable cassette into the cassette deck and close the cassette door.
5. Press **RECORD**  to start recording.
 - Playing of the CD programme starts automatically from the beginning of the programme. *It is not necessary to start the CD player separately.*





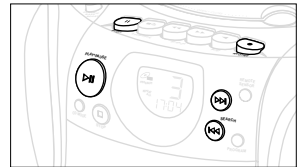

To select and record a particular passage within a track

- Press and hold down **SEARCH**  or  (or on the remote control  or ).
 - When you recognize the passage you want, release **SEARCH**  or  (or on the remote control  or .
 - To pause CD playback press **PLAY/PAUSE** .
 - Recording will begin from this exact point in the track when you press **RECORD** .
6. For brief interruptions during recording press **PAUSE II**. To resume recording, press **PAUSE II** again.
 7. To stop recording, press **STOP•OPEN** .



Recording from the radio

1. Tune to the desired radio station (See **TUNING TO RADIO STATIONS**).
2. Press **STOP•OPEN**  to open the cassette door.
3. Insert a suitable cassette into the cassette deck and close the cassette door.
4. Press **RECORD**  to start recording.
 - If you are recording from MW/LW stations, adjust the **BEAT CUT** switch to eliminate possible whistle tones during recording.
5. For brief interruptions, press **PAUSE** . To resume recording, press **PAUSE**  again.
6. To stop recording, press **STOP•OPEN** .

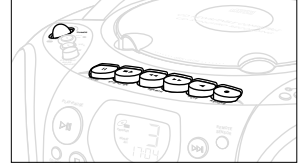

MAINTENANCE

Tape deck maintenance

To ensure quality recording and playback of the tape deck, clean parts (A), (B) and (C) shown in the diagram below, after approx. 50 hours of operation, or on average once a month. Use a cotton bud slightly moistened with alcohol or a special head cleaning fluid to clean the deck.

1. Open the cassette door by pressing **STOP•OPEN** .
2. Press **PLAY**  and clean the rubber pressure rollers (C).
3. Press **PAUSE**  and clean the magnetic heads (A) and also the capstan (B).
4. After cleaning, press **STOP•OPEN** .

Note: *Cleaning of the heads can also be done by playing a cleaning cassette through once.*

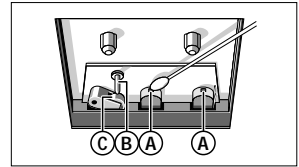

Environmental information

All unnecessary packaging material has been omitted. We have done our utmost to make the packaging easy to separate into three mono-materials: cardboard (box), expandable polystyrene (buffer), polyethylene (bags, protective foam).

Your set consists of materials which can be recycled if disassembled by a specialized company. Please observe the local regulations regarding the disposal of packing materials, exhausted batteries and old equipment.

TROUBLESHOOTING

If a fault occurs, first check the points listed below before taking the set for repair.
If you are unable to remedy a problem by following these hints, consult your dealer or service centre.

WARNING: *Do not open the set as there is a risk of electric shock. Under no circumstances should you try to repair the set yourself, as this would invalidate the guarantee.*

PROBLEM

– POSSIBLE CAUSE

- REMEDY

No sound/power

– VOLUME not adjusted

- Adjust the VOLUME

– Headphones connected

- Disconnect headphones

– Mains lead not securely connected

- Connect the mains lead properly

Severe radio hum or noise

– Electrical interference: set too close to TV, VCR or computer

- Increase the distance

Poor radio reception

– Weak radio signal

- FM: Direct the FM telescopic aerial for optimum reception

- MW/LW: Turn the set for optimum reception

or indication

– No CD inserted

- Insert a CD

– CD badly scratched or dirty

- Replace/ clean CD, see CD player and CD handling

– Laser lens steamed up

- Wait until lens has cleared

indication

– CD-R(W) is blank or the disc is not finalised

- Use a finalised CD-R(W)

– CD badly scratched or dirty

- Replace/ clean CD, see CD player and CD handling

The CD skips tracks

– CD is damaged or dirty

- Replace or clean the CD

– SHUFFLE or a programme is active

- Switch off SHUFFLE/PROGRAM

Poor cassette sound quality

– Dust and dirt on the heads, etc.

- Clean deck parts etc., see Maintenance

– Use of incompatible cassette types (METAL or CHROME)

- Only use NORMAL (IEC I) for recording

Recording does not work

– Cassette tab(s) may be broken

- Apply a piece of adhesive tape over the missing tab space

Remote control does not function properly

– Batteries dead/ incorrectly inserted

- Insert (fresh) batteries correctly

– Distance/ angle between the set too large

- Reduce the distance/ angle

*This product complies with the radio interference requirements of the European Union.
The type plate is located on the bottom of the set.*