

Magellan® RoadMate™

Reference Manual



Instructions for Operating the Magellan RoadMate 360

*** IMPORTANT SAFETY WARNINGS ***

The Magellan RoadMate 360 is a vehicle-navigation aid designed to assist you in arriving at your selected destinations. When using the Magellan RoadMate, these safety rules must be followed to prevent accidents that can result in injury or death to yourself or others:

- When driving, the need to view the display is minimal. Voice prompts will guide you to your destination. The driver should enter data or program the unit only when the vehicle is stopped. Only a vehicle passenger should enter data or program the unit while the vehicle is moving.
- It is your responsibility to comply with all traffic laws.
- While every attempt is made to ensure that the database is accurate, roadways, points of interest, and business and service locations may change over time. The database does not include, analyze, process, consider, or reflect any of the following: legal restrictions (such as vehicular type, weight, height, width, load and speed restrictions); road slope or grade; bridge height, width, weight, or other limits; population density; neighborhood quality or safety; availability or proximity of law enforcement, emergency rescue, medical, or other assistance; construction work zones or hazards; road or lane closures; road, traffic, or traffic facilities' safety or condition; weather conditions; pavement characteristics or conditions; special events; traffic congestion. It is your responsibility to disregard any unsafe, hazardous, or illegal route suggestions.
- Keep the Magellan RoadMate safe from extreme temperature conditions. For example, do not leave it exposed to direct sunlight for an extended period of time.
- Laws in some states prohibit wearing stereo headphones while operating a motor vehicle. Please contact your state's Department of Motor Vehicles for information.
- Take care when mounting the unit in your vehicle, whether using the windshield mount or other mount or accessories, that it does not obstruct the driver's view of the road, interfere with the operation of the vehicle's safety devices such as air bags, or present a hazard to occupants of the vehicle should the unit be dislodged while driving. You assume the risks associated with damage to your vehicle or vehicle occupants as the result of your choices in mounting the unit.
- Please refer to the Read Me First document supplied with your Magellan RoadMate for installation instructions.

© 2005 Thales Navigation, Inc. All rights reserved. The Magellan Logo, Magellan, RoadMate, Turn it on and go, TrueView, TrueFix, and QuickSpell are trademarks of Thales Navigation. No part of this user manual may be reproduced or transmitted in any form or by any means, electronic or mechanical, including photocopying and recording, for any purpose other than the purchaser's personal use, without the prior written permission of Thales Navigation.

Contact Information

If you need support for your Magellan RoadMate and you wish to contact Thales, please use the following information to direct your questions/comments to the proper person.

Technical Support

If you need technical assistance or “how-to” help, or if you have a technical question about the functionality of your Magellan product, please contact us on the Internet at www.magellangps.com or reach us by fax or by phone.

Our Technical Support phone representatives are available Monday through Friday, 6:00 a.m. to 5:00 p.m. PST/PDT. After hours, you may leave a detailed voice mail message that will be returned within the next business day.

Telephone: **(866) 868-2259** or **(909) 394-5000** (Outside North America)

You may also reach Technical Support by Fax: **(909) 394-7050** [Attn: Tech. Support]; or E-Mail: magellansupport@thalesnavigation.com

Warranty Service

To obtain warranty service on your unit, you must contact us for a return authorization before you ship the product. Packages arriving at our dock without an RA will be refused.

To obtain an RMA, simply contact our Technical Support group at: Telephone: **(866) 868-2259** or **(909) 394-5000**; Fax: **(909) 394-7050** [Attn: Tech. Support]; or E-Mail: magellansupport@thalesnavigation.com

Customer Service

If you need to order accessories, you can call our Customer Service Department Monday through Friday, 6:00 a.m. to 5:00 p.m. PST/PDT, or visit our Web site at www.magellangps.com.

Telephone: **(866) 339-0488** or **(909) 394-5000** (Outside North America); Fax: **(909) 394-7078**.

Table of Contents

Information	1
Technical Support	2
Warranty Service	2
Customer Service	2
About Satellite Navigation	1
How Satellite Navigation Works	1
Line of Sight	1
Precision	1
Placement of Your GPS Receiver for Optimal Satellite Reception	2
A Word on the Safe Usage of GPS Maps	2
From Source to Destination	2
GPS Maps and Your Safety	3
Care and Use of the Pre-Installed Secure Digital (SD) Card	3
To Insert the SD Card:	4
To remove the SD card:	4
Magellan RoadMate	5
Front View	5
Rear View	5
Left- and Right-Side Views	6
Bottom View	6
Installation	7
Installing the Windshield Mount	7
Installing the External Antenna	8
Basic Operation	10
Turning the Magellan RoadMate On	10
Inputting Text Characters	11
Additional Characters (More)	12
Numerical Characters (123)	12
Using QuickSpell® and AutoFill™	12
Help with Street Names	13
Selecting Destinations	14
Choosing the Route Method	15
Changing the Route Method	16
Cancelling a Planned Route	17
Detouring from the Planned Route	18
Excluding a Maneuver in a Planned Route	18
Accessing Regions	19
Selecting a Destination Using “Select Address”	21
Selecting a Destination Using “Address Book”	23
Previous Destinations	23
Routing to A Previous Destination	23
Saving a Previous Destination to your Address Book	24
List Addresses	25
List All	25
Route	26
Edit	26
Delete	27
List Favorites	27
Route	28
Edit	28
Delete	29

Table of Contents

Search Address Book	29
Route	30
Edit	31
Delete	31
Create New Entry	31
Select on Map	31
Select Address	33
Dining, ATM, Gas... ..	35
Search POI by Name	35
Search Nearest POI	38
Intersection	41
Trip Planner	43
New	43
Edit	45
Delete, Rename	46
Delete	47
Rename	47
Selecting a Destination Using “Dining, ATM, Gas...”	49
Search POI by Name	49
Nearby Current Position	49
Nearby City Center	50
Search Nearest POI	51
Current Position	52
By City Center	53
By Airport	54
Selecting a POI on the Map	55
Selecting a Destination Using “Intersection”	57
Traveling	59
Guidance Information Screens	59
Map Screen	60
Changing the Map Zoom Levels	60
Maneuver List Screen	61
TrueView Screen	61
Current Location	62
Displaying Information About Your Current Location	62
Save Location	62
User Options	63
User Option Menu	63
Trip Computer	64
Stopping or Starting the Trip Computer	64
Saving the Current Trip Report	64
Resetting the Trip Computer	65
Viewing a Saved Trip Report	65
Deleting a Trip Report	66
Track Recorder	67
Start Track Recorder	67
Stop Track Recorder	67
Save Track Record	68
View Track	69
Delete, Rename Track	70
Configuration	72
Brightness	72
Volume	72

Table of Contents

Auto Power Off	73
Language	73
User Settings	74
POI Selection	74
Map Options	75
Map Orientation	75
Units of Measure	75
Map Guidance Option	75
Select Map Color	75
Route Preferences	76
Split TrueView	76
Menu Colors	77
Tone Options	77
Diagnostics	78
Video Test	78
Touch Screen Test	78
Keypad Test	78
Audio Test	78
Headphone Test	79
Product Information	81
Simulator Mode	81
System Messages	82
User - Edit Name	82
Password Settings	83
Appendix	84
GPS Status Screen	84
GPS STATUS Screen Structure-first page	84
Bad fix code	84
GPS STATUS Screen Structure - second page	85
Typical GPS STATUS Screen Display	86
POI Categories	87
Specifications	89

Information

About Satellite Navigation

Global satellite navigation is an exciting technology, providing enhanced productivity and accuracy in a vast number of industries. It adds a new level of enjoyment and safety to a wide range of navigation, sports, and recreational activities.

A Global Navigation Satellite System (GNSS) is a network of satellites that transmit high-frequency radio signals containing time and distance data that can be picked up by a receiver, allowing users to pinpoint their precise locations anywhere around the globe.

There are two Global Navigation Satellite Systems in operation: the U.S. Global Positioning System (GPS) and the Russian GLObal NAVigation Satellite System (GLONASS). These systems are constantly being upgraded to meet higher standards of reliability. A third GNSS named GALILEO, after the Italian astronomer of the early 1600s, is being developed in Europe specifically to provide a higher standard of integrity and reliability, required to ensure the safety of lives during transport by air, land and sea, without the use of additional augmentation systems.

While the GPS and GLONASS satellite networks are being developed to achieve maximum performance, Satellite-Based Augmentation Systems (SBAS) have been established to provide improved accuracy. SBAS provides differential signal corrections for GPS and GLONASS transmissions with the use of ground stations and geostationary satellites in specific regions. This is GNSS-1, the first phase in establishing the required integrity for high-precision satellite navigation.

GNSS-2 requires the launching of new satellites into orbit and a complete upgrade of the existing satellite systems. This second phase is already well underway. GALILEO, scheduled to begin service in 2008, is being developed to meet the standards of GNSS-2 for rapid and reliable, certified precision positioning.

How Satellite Navigation Works

Global navigation satellites continuously transmit time and distance information as they orbit the earth in a precise formation. Navigation satellite receivers use this information to calculate an exact location through triangulation. Every point on Earth is identified by two sets of numbers called coordinates. These coordinates represent the exact point where a horizontal line, known as latitude, crosses a vertical line, known as longitude. The receiver locks on to at least three satellites and uses the information received to determine the coordinates of the receiving device.

By comparing the time the signals were transmitted from the satellites and the time they were recorded, the receiver calculates how far away each satellite is. The distance of the receiver from three or more satellites reveals its position on the surface of the planet. With these distance measurements, the receiver might also calculate speed, bearing, trip time, distance to destination, altitude, and more.

The satellite-navigation device may display its position as longitude/latitude, Universal Transverse Mercator (UTM), Military Grid (MG), or simply as a point on an electronic map. Many Thales Navigation receivers provide comprehensive mapping data, making satellite navigation an easy tool to enhance your recreational and industrial activities.

Line of Sight

Satellite-navigation receivers operate by line of sight with global-positioning satellites. This means that at least three satellites must be in "view" of a receiver in order to calculate longitude and latitude. A fourth satellite must also be within line of sight to calculate altitude. On average, eight satellites are continuously within line of sight of every position on Earth; the more satellites in view, the more accurate the positioning.

Though the radio signals of navigation satellites will pass through clouds, glass, plastic, and other lightweight materials, satellite-navigation receivers will not work underground or in other enclosed spaces.

Precision

On average, a satellite-navigation receiver is accurate to within 15 meters. Thales Navigation employs several technologies to increase the accuracy of their professional and Magellan®-branded receivers. An accuracy of 3 meters or better is achieved using correction signals from satellite navigation-augmentation systems. In the U.S., an accuracy of 3 meters is achieved using signal corrections from a network of ground stations and fixed-position satellites known as WAAS (Wide-Area Augmentation System). Throughout Europe a similar system, EGNOS (European Geostationary Navigation Overlay System), provides the same accuracy. In Asia, satellite navigation-signal correction is provided by MSAS (Multifunctional Transport Satellite-based Augmentation System). Other ways to

Information

increase the accuracy of satellite navigation include the use of DGPS (Differential Global-Positioning System); ground relay stations, set at known positions, transmit corrected satellite-navigation signals. Various methods and applications of DGPS can increase satellite navigation accuracy from a few meters to within a few millimeters. Using DGPS requires a differential-beacon receiver and antennae in addition to a satellite-navigation device. Accuracy can also be increased using an RTK (Real-Time Kinematic) satellite-navigation system. This is a receiver capable of transmitting a phase-corrected signal from a known position to one or more rover receivers.

A number of positioning errors can occur, limiting accuracy to within 15 to 25 meters. These errors are monitored and compensated for in a number of ways:

Orbiting errors -- Occasionally a satellite's reported position does not match its actual trajectory. In the U.S., the Department of Defense continuously monitors each satellite, making orbital corrections with onboard booster rockets.

Poor geometry -- If all of the satellites within line of sight of a receiver are clustered closely together, or lined up relative to the position of the receiver, the geometric calculations necessary for triangulating a position become difficult and less reliable. The use of differential-correction signals from satellite-based augmentation systems or DGPS can compensate for both orbital errors and poor geometry.

Multipath signals -- Signals may be reflected off tall buildings or other obstructions before reaching the receiver, increasing the distance a signal travels and reducing accuracy.

Thales Navigation receivers make a number of complex mathematical calculations to effectively compensate for other potential errors in positioning:

Atmospheric delay -- Satellite-navigation signals slow as they pass through the Earth's atmosphere. Thales Navigation receivers calculate the average delay in nanoseconds to compensate.

Clock errors -- The clock built into a receiver is not as accurate as the atomic clock on a navigation satellite, which is accurate to one second every million years. Each Thales Navigation receiver compensates for time differentials by comparing the time signals of several satellites and adjusting its calculations and its clock to match.

Placement of Your GPS Receiver for Optimal Satellite Reception

Firstly, before considering signal reception, it is important to understand that your GPS receiver is a sensitive piece of equipment. You should never place it in an area of your vehicle where it may be struck by other items, or where vibration may cause it to strike other items or parts of the vehicle. The windshield mount included in the box allows you to place the receiver in such a way that the antenna can receive the satellite signal through the windshield without being obstructed by other parts of the vehicle. However, tinted windows or other reflective coatings may interfere with reception. In this case, it may be required to attach an external antenna (optional). The external antenna mounts to the outside of your vehicle and is therefore not hampered by tinted windows. Other mounting solutions are available but may require an external antenna.

External conditions also affect GPS signal reception. Although weather conditions do not affect the signal, tall buildings and trees, driving through canyons, wooded areas, or tunnels, and sitting in a garage or covered parking area will affect the GPS signal. The GPS receiver constantly monitors and updates the GPS signal status and will reacquire the signal once it is clear of any obstructions.

A Word on the Safe Usage of GPS Maps

Just like paper maps, maps on GPS devices vary greatly in terms of information included and visual presentation. Whether topographical maps, roadmaps or marine charts, each map and the data it presents is designed for a specific purpose. For example, marine charts will often present only a minimal representation of roadways and are not a substitute for street maps. Topographic maps usually provide minimal detail about bodies of water, and do not contain marine navigational markers.

Maps also vary widely in scale: the smaller the scale, the more detailed the map. Therefore, when using GPS maps (just as with paper maps) it is important to consider what type of map you are using in your explorations and to use common sense.

From Source to Destination

Thales Navigation, maker of Magellan GPS products, is not a cartography company. We do not create the maps that are used on our GPS devices. We seek to acquire map data from the best public and private sources available at the

Information

time of publication. Thales Navigation licenses* topographical maps, roadmaps, marine charts and points of interest data from commercial and governmental cartographic sources that provide raw map data. Thales Navigation processes and compresses the raw data into a format that makes it presentable and manageable to work on our GPS devices. And to ensure that our map data is as robust as possible, data from multiple sources are often combined to provide a better user experience for our customers. This processing does not alter the landforms, coordinates or other spatial data that comes in the raw data. The accuracy of the maps is fundamentally dependent on the source data used to create them. Map data changes frequently due to both natural and man-made causes. As a result, governmental and commercial cartography companies must continuously review correct and improve upon their map data. We release new versions of our maps on a regular basis to reflect these changes.

After processing the data, we test the compatibility of the map with our GPS devices to ensure that the products we release work properly on our GPS devices. We also beta test our products to get customer feedback prior to release.

GPS Maps and Your Safety

Remember, your GPS device is an aid to navigation. It must be used with common sense and it is important that users interpret GPS map data with a critical eye. Landscapes and roads change or may be impassable, trees and tall buildings can obscure GPS signals and your GPS device may not always reflect the complete picture. When using GPS, you must combine the information provided by your GPS map with your relevant local knowledge, road signage, buoys, depth soundings and changing local conditions to generate a complete understanding of your situation.

It is your responsibility to ensure compliance to all traffic laws, including pedestrian observance of crosswalks, and to use good judgment while operating the Magellan GPS receiver. Safety must be your primary concern. The Magellan GPS receiver must not be used while engaged in any activity requiring the user's full attention to the environment. For instance, the Magellan GPS receiver should be operated only by vehicle passengers or by the driver when the vehicle has come to a complete stop. The driver must not attempt to view the display while driving. A climber must not attempt to view the display while negotiating treacherous terrain. Disregard any unsafe, hazardous or illegal route suggestions.

Magellan maps do not include, analyze, process, consider or reflect any of the following: legal restrictions (such as weight, height, width, load and speed restrictions); road slope or grade; bridge height, width, weight or other limits; population density; neighborhood quality or safety; availability or proximity of law enforcement, emergency rescue, medical or other assistance; construction work zones or hazards; road, sidewalk or waterway closures or conditions; weather conditions; pavement characteristics or conditions; special events; traffic congestion; time of day.

*Thales Navigation licenses map data from governmental sources such as, but not limited to, US Geological Survey (USGS), the National Oceanic and Atmospheric Administration (NOAA-NOS) and the Canadian Hydrographic Service (CHS). Thales Navigation licenses map data from commercial cartography companies such as Navigation Technologies, Navionics, DMTI and C-Map.

Care and Use of the Pre-Installed Secure Digital (SD) Card

The Magellan RoadMate 360 comes with an SD card that is pre-installed in the unit. The SD card is a small, lightweight flash memory device that allows increased data storage for your Magellan RoadMate. The compact size is ideal for storing large amounts of data and not taking a lot of physical space. This card contains map data that covers the entire United States and Canada and should never need to be removed. However, in the event that the SD Card should be removed from the unit, reinstalling it is simple and fast.

The SD card slot on your Magellan RoadMate employs what is called a “push-push” method of locking and releasing. In other words, when you insert the card you must push it to lock it in, and to release it you must push it also. **It is important to remember to never remove or insert the SD card when the unit is on.** Always make sure to turn the power off when removing or inserting the SD card. Failure to do so may cause the unit or the data on the SD card to become corrupt or unusable.

Information

To Insert the SD Card:

Peel back the rubber gasket to expose the SD card slot. Do not completely remove the rubber gasket.

The SD card can only be inserted in one direction. Do not force the card into the slot.

Insert the SD card into the slot with the metal contacts going in first and the beveled edge to the left.

Push the SD card until you hear a click.

Close the rubber gasket.

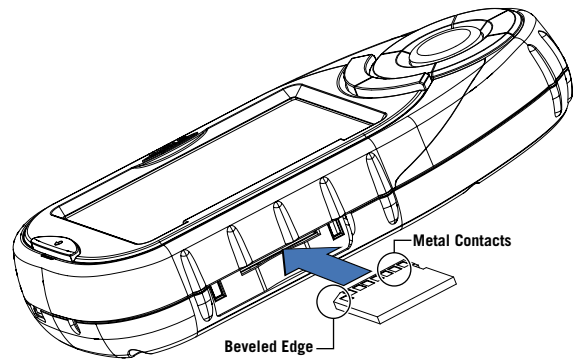

To remove the SD card:

Peel back the rubber gasket to expose the SD card slot. Do not completely remove the rubber gasket.

Push the SD card until you hear a click. Do not attempt to pull the card out of the slot

Remove the SD card from the slot.

Close the rubber gasket.

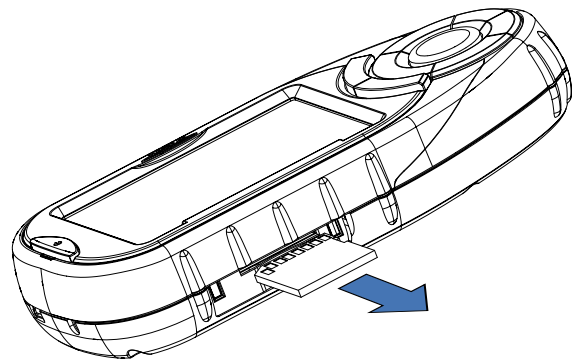

Magellan RoadMate

Front View

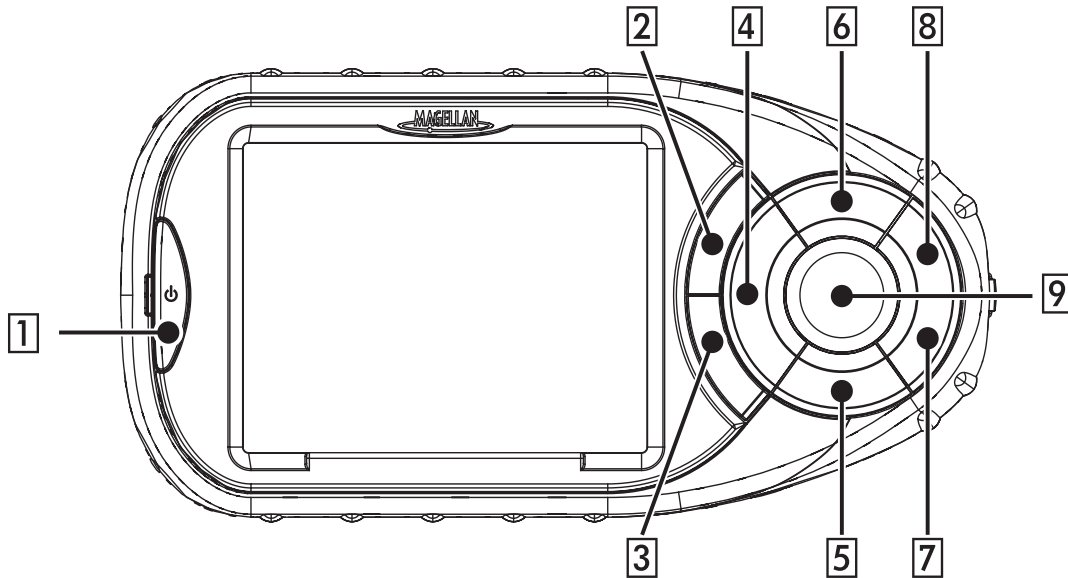

1	Power	Press to turn the Magellan RoadMate on or off.
2	Zoom In	While viewing the map, press to enlarge the map view
3	Zoom Out	While viewing the map, press to shrink the map view
4	View	Switch between Map, Maneuver List, and TrueView
5	Locate	Show details of your current location and save it to your address book
6	Option	Access customizable features
7	Cancel	Cancel changes and selections
8	Enter	Confirm menu selections and text input, repeats last voice prompt during routing while on the Map Screen
9	Navigation Key	Select menu options, characters, and pan map

Rear View

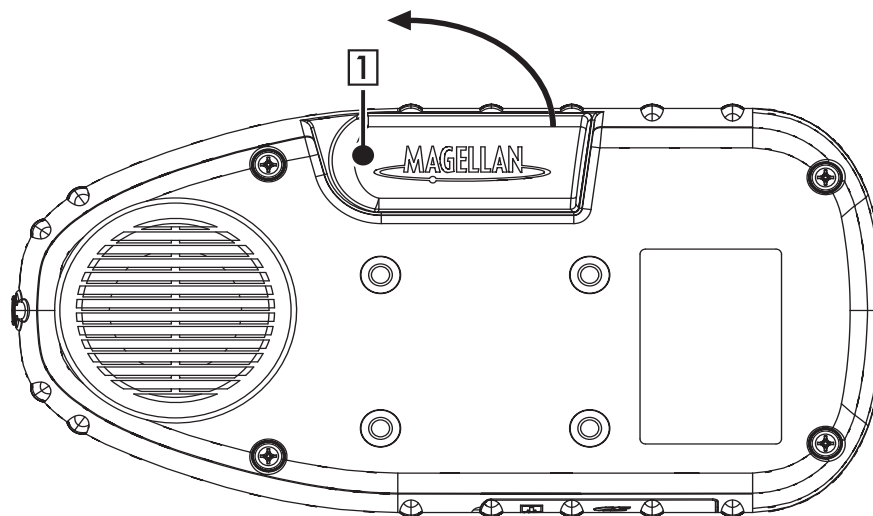

1	Antenna	Rotate up when in use to receive signals from the GPS satellite network
---	---------	---

Magellan RoadMate

Left- and Right-Side Views

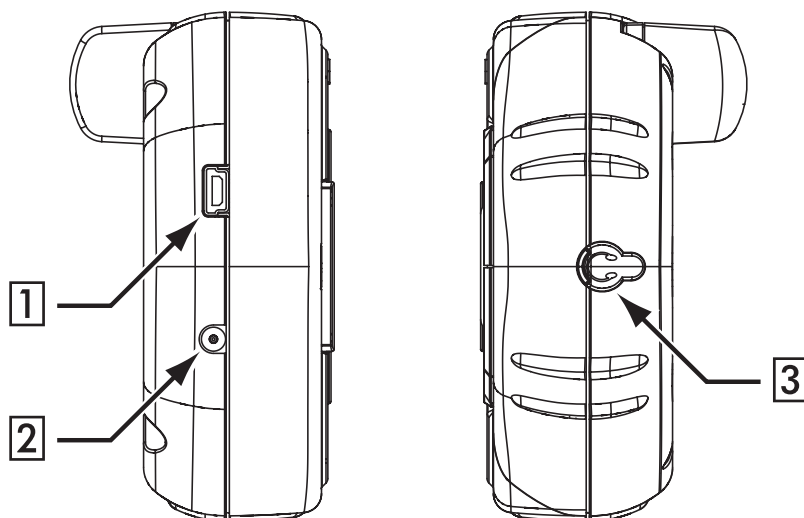

1	USB Connection	Connect to your PC to upload map data or software updates
2	Power Connection	Plug into your vehicle or at home
3	Headset Connection	Plug in an earpiece for noisy areas

Bottom View

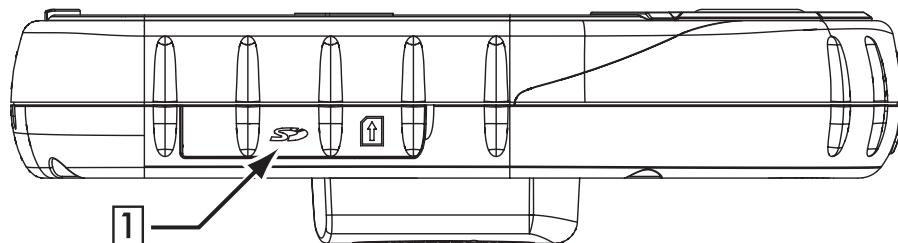

1	SD Card Slot	Secured Digital (SD) Card slot
---	--------------	--------------------------------

Installation

Take care when mounting the Magellan RoadMate in your vehicle, whether using the windshield mount or another mount, that it does not obstruct the driver's view of the road. Make sure that the placement of the Magellan RoadMate and cable does not interfere with the operation of vehicle safety devices, such as air bags. You assume the risks associated with damage to your vehicle or your vehicle's occupants as a result of how you choose to mount the Magellan RoadMate.

Installing the Windshield Mount

Slide the mount assembly onto the windshield mount bracket attached to the back of the unit.



Press the windshield mount to the glass and rotate the locking lever toward the glass until it locks into place.



Plug the power cable into the unit.



Plug the cigarette lighter connector into an appropriate 12V receptacle in your car.



Installation

Rotate the antenna upward.



Installation is complete. You are ready to turn the Magellan RoadMate on and go.

Installing the External Antenna

The external antenna (not included) provides faster satellite fix times and greater signal strength. Because it is mounted outside of the vehicle, it is not affected by reflective coatings on windows and has an unobstructed line of sight to the satellites.

Remove the standard antenna by rotating it completely upward.



Hold the antenna at the pivot point and pull straight off the back of the unit.



Attach the antenna to a flat, horizontal portion of the roof of your vehicle. The antenna is magnetic. **Do not use any adhesives to attach the antenna to your vehicle.**



Installation

Route the antenna cable along the weatherstripping of the door and through the vehicle interior so it such a way that it does not interfere with the operation of the vehicle.



Plug the end of the external antenna into the socket on the back of the unit.

Replace the unit onto the mount in your vehicle. There is no special settings to make to the unit in order to use the external antenna. Turn the unit on and operate normally.



Basic Operation

Turning the Magellan RoadMate On

Press the **Power** button. The Power button is located on the left side of the unit. See “Front View” on page 5 for button locations.

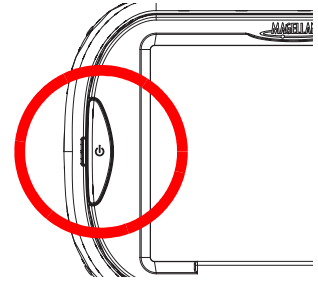

If power is properly connected, a logo screen is displayed.



Next, you will need to select the language you wish to use for your Magellan RoadMate. The language selection will be used for menu text and audible voice prompts.



The Warning screen will appear. At the bottom of the screen, select your preferred user. The Magellan RoadMate can be personalized for three different users.

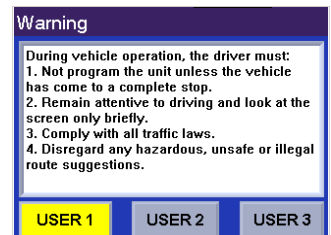

The Magellan RoadMate will display a series of help screens to guide you through the selection of map regions. Select **OK** to proceed to the next screen or, Select **Don't Show Again** to proceed to the next screen and not show the Help sequence at start-up next time.



Next you will need to decide on which regions you travel within most often. Select **OK** to proceed to the next screen or, select **Back** to view the previous screen.

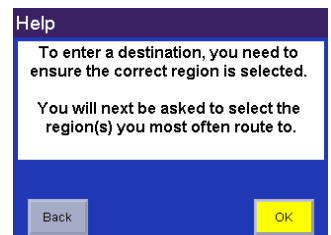

Basic Operation

Selecting only one region will greatly speed up the time it takes to search for addresses and POIs. Select **OK** to proceed to the next screen or, select **Back** to view the previous screen. If you do not wish to view this screen each time you select a map region, select **Don't Show Again**.

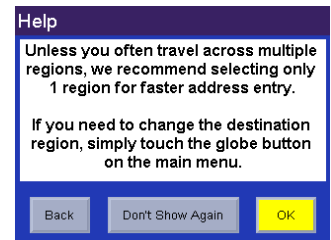

Select the geographical area you most often travel within.

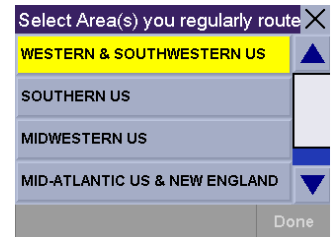

Next, to narrow down further, select the regions you most often travel within. If you often travel between states that are not contained within one region, you may want to select both regions. Select **Mark All** to choose all available regions, select **Clear All** to deselect all regions. When you have selected at least one region, select **Save**.

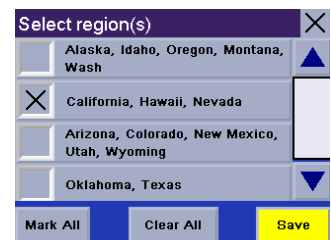

The region is active and the Select Destination screen will appear.

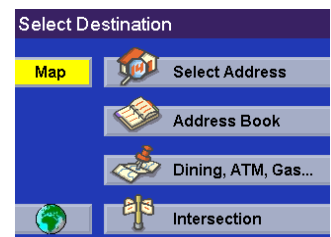

Inputting Text Characters

Whenever you need to input names, street addresses, etc., the Magellan RoadMate will display a key pad. Touch the screen or use the navigation key to input text.

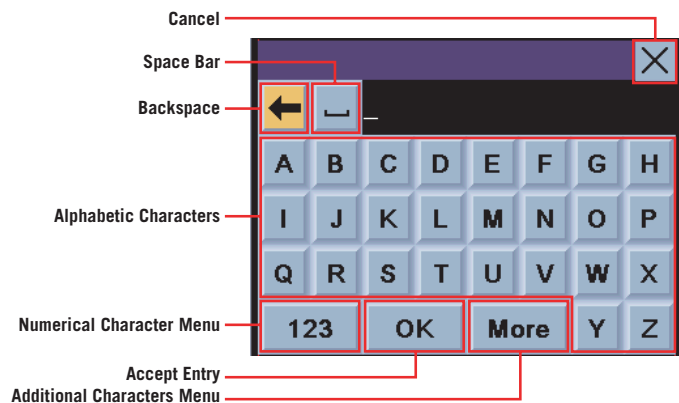

Basic Operation

Additional Characters (More)

When you are entering information, you may need to add punctuation or other special characters. When available, select **More** to bring up the additional characters.



Numerical Characters (123)

You may also need to add numbers to your text. When available, select **123** to bring up the numeric keypad.



Using QuickSpell® and AutoFill™

The Magellan RoadMate uses QuickSpell technology to provide you with the fastest method possible to enter characters. QuickSpell eliminates the possibility of a misspelled word or looking for a city or street that is not in the database. As you begin entering characters, the QuickSpell feature of the Magellan RoadMate dims out those characters that are not available, thereby speeding up the process of entering data.

With AutoFill, as you enter characters the next name in the database matching the characters entered is displayed in the speller.

Suppose that you need to input the name of a city, in this case, San Francisco.

Select "S". Also as you enter characters, the next city in the database matching the characters inputted will show in the speller.



Continue to enter characters. When you have entered enough characters to match the desired city, it will show in the speller. **OK**.

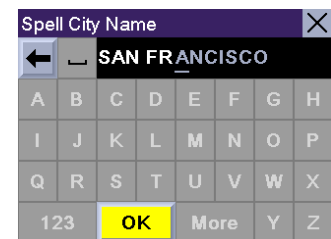

Basic Operation

However, because the city search lists all cities in the database matching the characters inputted, it is possible to select a city that does not contain the street selected previously.

In this case, you can either select **Street** to re-enter the street name; select **City** to choose only from cities that contain the desired street; or choose **Back** to continue spelling the city name. For this example select **City**.

Enter the name of the desired city. Notice this time you enter fewer characters to match the desired city in the speller.

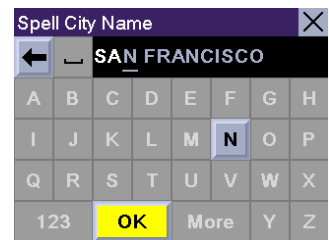
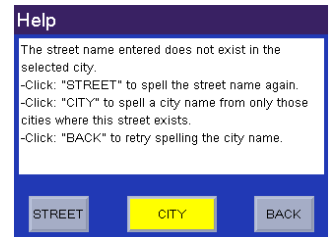

Help with Street Names

When entering names of streets, it is important to follow a few simple guidelines. Press the Help button on the Spell Street screen.

First, only enter the street name, do not enter any prefixes or suffixes such as "North" or "N", "South" or "S". Do not enter the street type such as "St" or "Ave". For example, if the street you are looking for is "N. Foothill Blvd.", you would simply enter "Foothill".

Second, when entering numbered streets, use the numeric keypad to enter the street followed by entering the identifier using the alpha keypad. Do not spell the street name. For example, if the street you are looking for is "4th Street", use the numeric keypad to enter the number "4", then, switch back to the alpha keypad to enter "th". Do not spell "Fourth" unless the name of the street starts with the word "Fourth" such as "Fourth Army Rd."

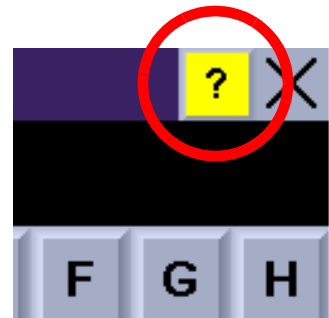

Selecting Destinations



Select Address



Select Region†

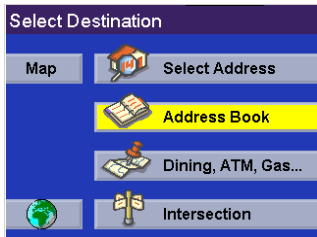

Address Book



Previous Destinations

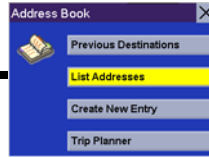

List Addresses

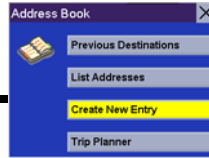

Create New Entry

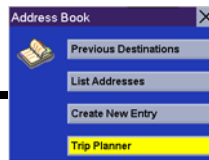

Trip Planner

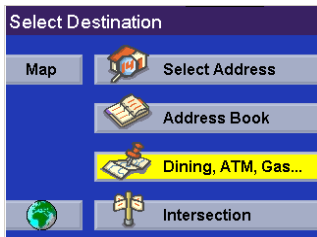

Dining, ATM, Gas...



Search POI by Name



Search Nearest POI



Select Region†

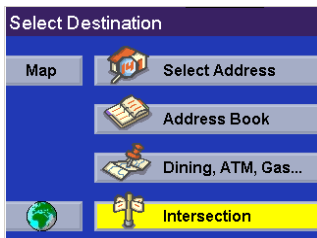

Intersection



Select Region†

† If more than one region is active, you will be asked to select the region from which to search.

Selecting Destinations

Choosing the Route Method

Every route is calculated based on the Route Method criteria selected. Every time a new destination is selected, the Magellan RoadMate prompts you for the method that will be used to calculate the route.

Shortest Time: This selection calculates a route that should take the least amount of time using known speed limits, streets, and other information in the database. Other factors such as traffic conditions, road closures, and emergency activity are not factors in the calculation of shortest time.

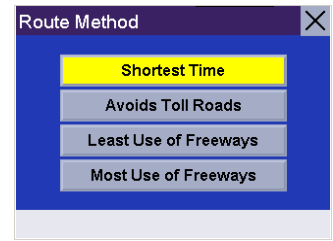

Avoid Toll Roads: This option calculates the route by excluding known toll roads from the calculation whenever possible. This option may not reflect the shortest time.

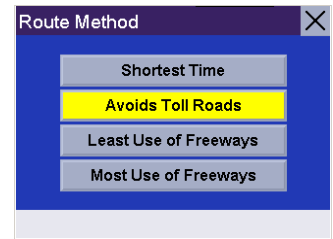

Least Use of Freeways: This selection calculates the route by avoiding freeways whenever possible.

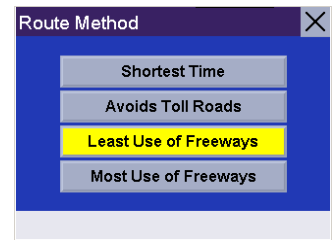

Most Use of Freeways: This selection calculates the route by using freeways as much as possible.

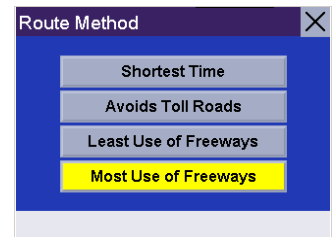

Selecting Destinations

Changing the Route Method

While viewing the Map screen, the Maneuver List screen, or the TrueView 3D screen, press the **Cancel** button.

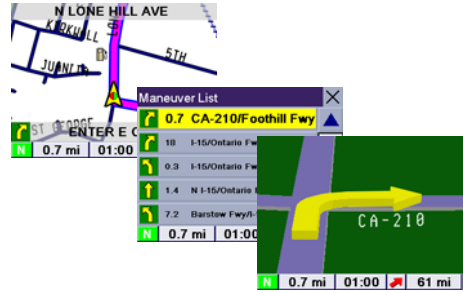

Select **Route**.

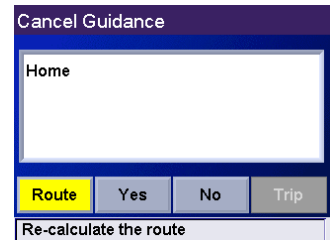

Select the new Route Method.

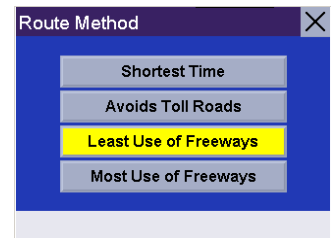

The route will be re-calculated using the new Route Method chosen and the Map screen will be displayed. Press the **View** button to see the Maneuver List with the new route.



Selecting Destinations

Cancelling a Planned Route

While viewing the Map screen, the Maneuver List screen, or the TrueView 3D screen, press the **Cancel** button.

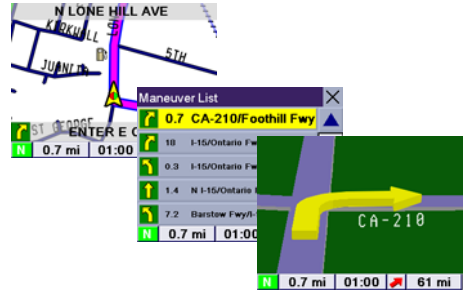

Select **Yes** to cancel the route and display the Select Destination screen.

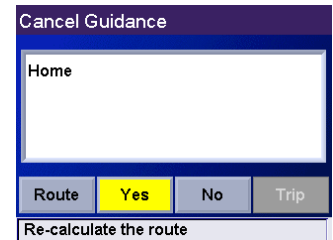

Select **No** returns the display to the last viewed screen.

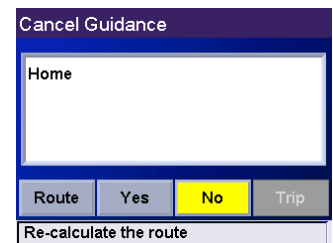

Selecting Destinations

Detouring from the Planned Route

If you detour from the calculated route, the Magellan RoadMate will get you back on course in one of two ways:

1. If you detour from the calculated route to stop at a gas station or a convenience store, and the unit shuts off as you turn off the car, or you turn off the unit manually, when you return to your vehicle and the unit is turned back on, you are presented with a screen asking if you want to resume your route. Selecting "Resume" causes the Magellan RoadMate to recalculate the route using the same destination as before, selecting "Cancel" clears the route and displays the Select Destination screen.
2. If you detoured from the calculated route due to a traffic jam or construction, the Magellan RoadMate will automatically recalculate the route to your destination based on your new location.

By default, the Magellan RoadMate will continue to recalculate the route as long as you choose to keep it active.

Excluding a Maneuver in a Planned Route

While traveling or setting up your destination, you may find it necessary to exclude one of the maneuvers in the Maneuver List. This could be due to an accident or street maintenance you want to avoid. The Magellan RoadMate provides you with tools to select a specific maneuver, exclude it from the planned route, and recalculate the route when possible.

Within an active planned route and while viewing the Guidance screen, press View.



Select the maneuver instruction to be excluded.



The details for the maneuver are displayed. Select **Exclude**.

The trip will be re-calculated, excluding the maneuver selected. This calculation is done using the same Route Method that was chosen when the destination was selected. After the route is recalculated, the Map screen is displayed.

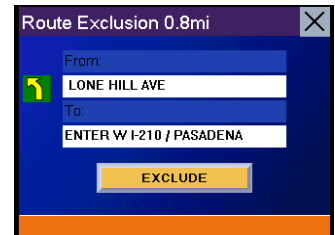

Selecting Destinations

Accessing Regions

When you first start-up your Magellan RoadMate, you were asked to select a default region. This region is one you travel within most often. By having only one region active, the time it takes to search for an address is greatly decreased. If you have selected more than one active region, when you search for an address, you will be asked to narrow down the search by selecting which active region the address is in. If the address you are searching for is not within any active region, you can select the Globe button to activate the region you wish to search from.

Select the **Globe**.



A dialog box will appear with the active region status. Select **Yes**.

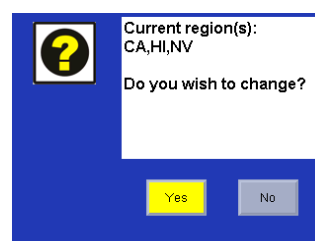

Next you will need to decide on which regions you travel within most often. Select **OK** to proceed to the next screen.

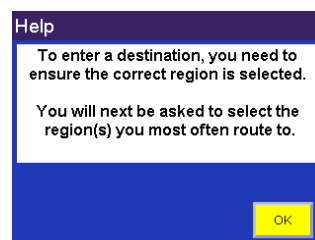

Selecting only one region will greatly speed up the time it takes to search for addresses and POIs. Select **OK** to proceed to the next screen or, select **Back** to view the previous screen. If you do not wish to view this screen each time you select a map region, select **Don't Show Again**.

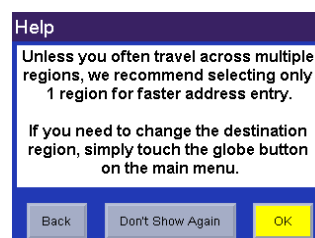

Select the geographical area.

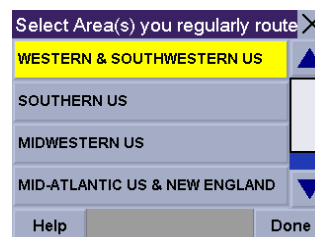

Selecting Destinations

Select the region you wish to activate. Select **Mark All** to choose all available regions, select **Clear All** to deselect all regions. When you have selected at least one region, select **Save**.

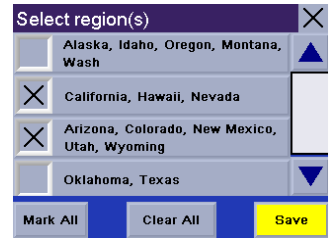

If you select more than one region to activate, you will be prompted to select the region when searching for an address. Select **OK**.

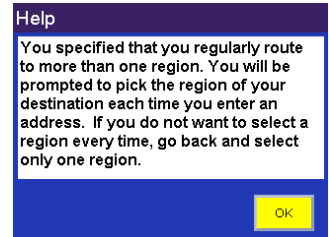

Select **OK**.

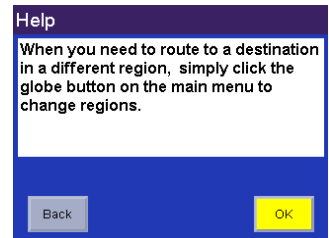

If you select only one region to make active, all address and POI searches will be from this region.

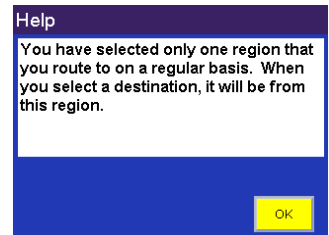

Select **OK**.

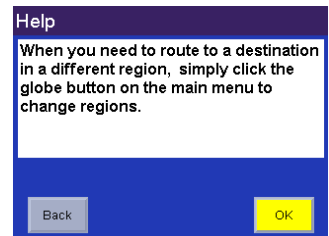

The region is active and the Select Destination screen will appear.

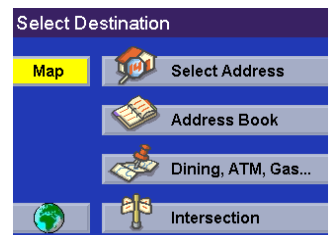

Selecting Destinations

Selecting a Destination Using “Select Address”

A destination can be created by entering the street address that you want to go to. This address is not automatically added to your Address Book but is saved to your Previous Destination list (which is part of the address book menu) if you have routed to it.

From the Select Destination screen, select **Select Address**.



If more than one region is active, you will be asked to select the region from which to search.

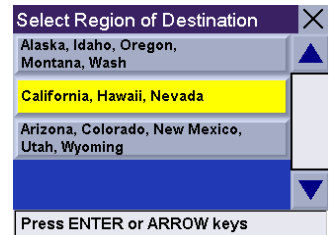

Enter the base name for the street. For example, if you are searching for “Overland Court” you would enter “OVERLAND”. As you type, the AutoFill will show the next possible match from the database. Select **OK**. For additional help with entering street names, see “Help with Street Names” on page 13.



Next, if the street you are looking for is within two to five cities, select the desired city from the list. If the desired street is within more than six cities, you will need to narrow down your search further by entering the city name. Again, as you type, AutoFill will display the next possible match. Select **OK**.

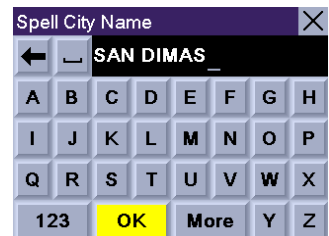

Enter the street address. The acceptable range of numbers is displayed at the top of the screen. If you do not know the exact address, just select **Done** and the Magellan RoadMate will route you to the lowest number in the range. When an acceptable street address has been entered, select **Done** to continue.

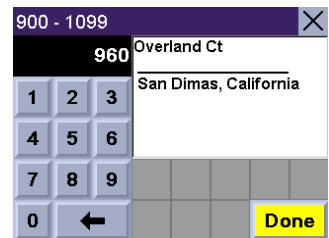

Selecting Destinations

Select the desired Route Method.

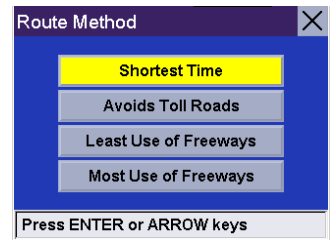

The Magellan RoadMate will calculate the route. When the calculations are complete, the Map screen will be displayed

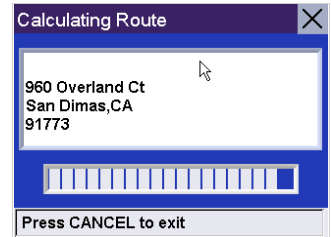

Selecting Destinations

Selecting a Destination Using “Address Book”

The Address Book can store up to 200 addresses for each of the three users. When you select “Address Book” you are given four options. Selecting “Previous Destinations” lets you select from a list of the last 50 destinations you have routed to with the option of saving them to your address book. “List Addresses” displays a list of all the addresses you have stored in your Address Book. “Create New Entry” lets you create a new address and store it in your address book. “Trip Planner” lets you select two or more addresses from your Address Book to route to in sequence.

Previous Destinations

Routing to A Previous Destination

From the Select Destination screen, select **Address Book**.

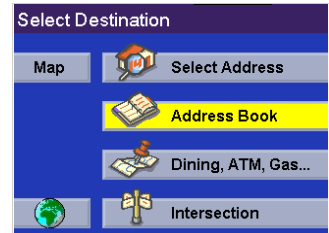

Select **Previous Destinations**.

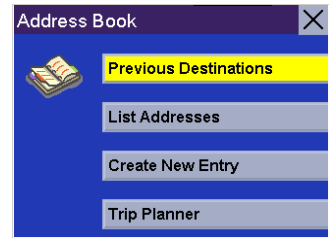

Select from the list of previous destinations.



Select **Route** to be routed to the selected city.

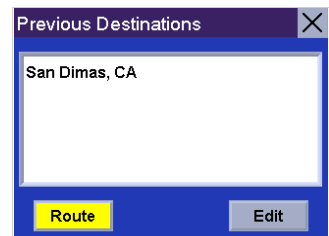

Select the desired Route Method.

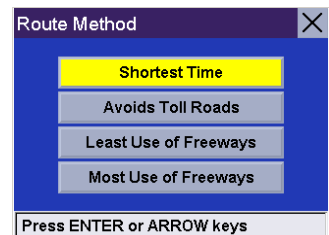

Selecting Destinations

The Magellan RoadMate will calculate the route. When the calculations are complete, the Map screen will be displayed

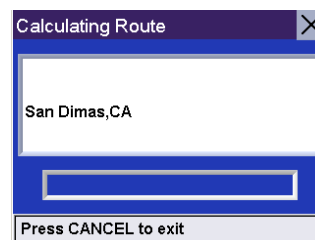

Saving a Previous Destination to your Address Book

From the Select Destination screen, select **Address Book**.

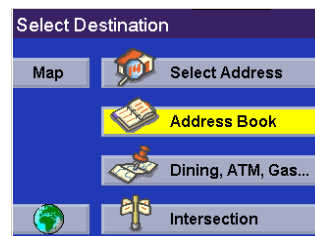

Select **Previous Destinations**.



Select the address that you wish to save.



To save this destination to the Address Book, select **Edit**.

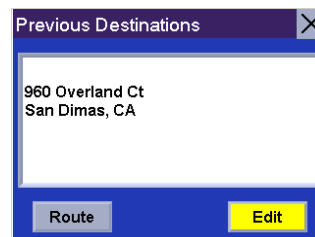

The top line (Name) and the bottom line (Information) can be edited. The address cannot be changed. Select the line you want to modify.

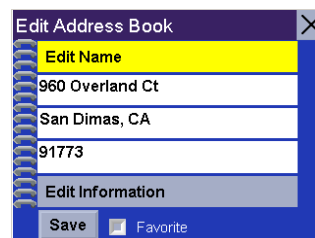

Selecting Destinations

Enter the desired text. Select **OK**.

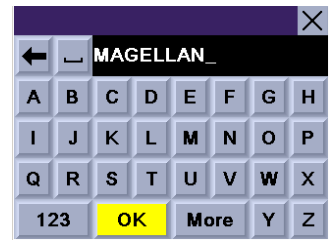

You can also add this address to your Favorites list. Select **Favorites**.

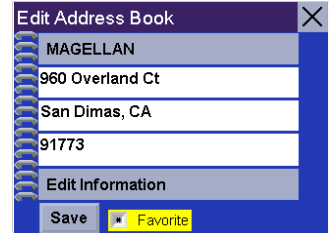

When you are satisfied with the information, select **Save**.

The address is saved to the Address Book. Press **Cancel** to return to the Previous Destinations screen.

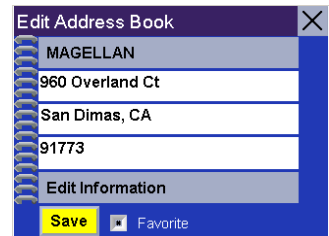

List Addresses

List All

From the Select Destination screen, select **Address Book**.

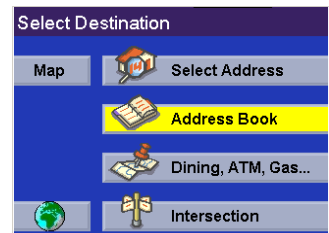

Select **List Addresses**.

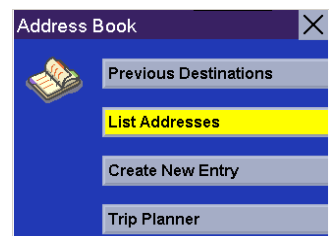

Select **List All**.

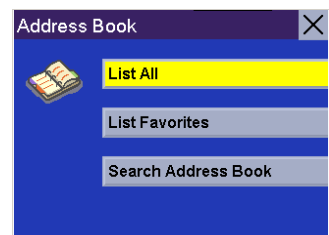

Selecting Destinations

Select the destination from the list of addresses in the Address Book and press **Enter**. You will then have the option of routing to, editing, or deleting this address.

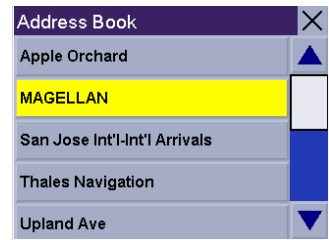

Route - Select **Route**.

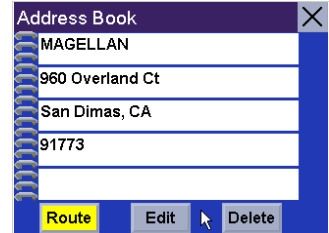

Select the desired Route Method.

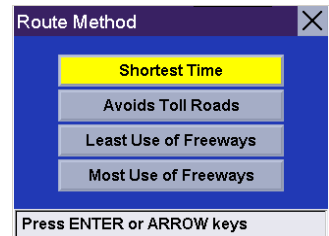

The Magellan RoadMate will calculate the route. When the calculations are complete, the Map screen will be displayed.

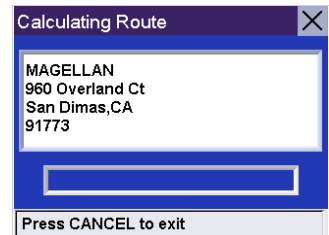

Edit - Select **Edit**.

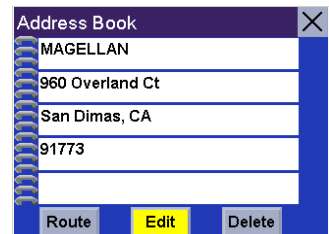

Click on either the top line (name) or the bottom line (information) and enter the desired text.

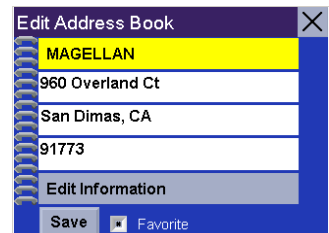

Selecting Destinations

Select **Save** to save the changes and return to the Address Book screen.

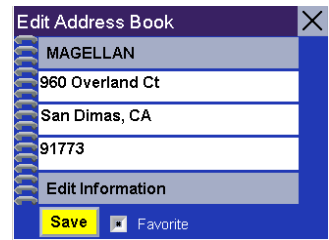

Delete - Select **Delete**.

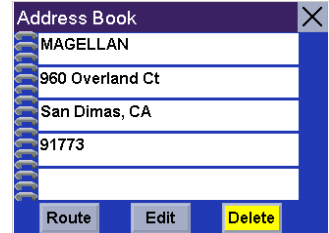

A dialog box will appear prompting you to confirm the deletion. Select **Yes**.

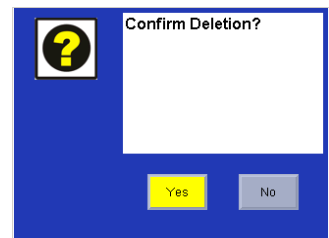

The address has been deleted from your address book and you are returned to the Select Destination screen.

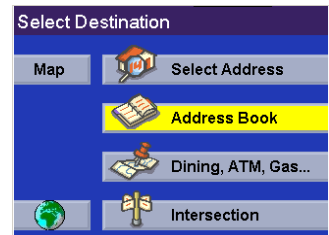

List Favorites

From the Select Destination screen, select **Address Book**.

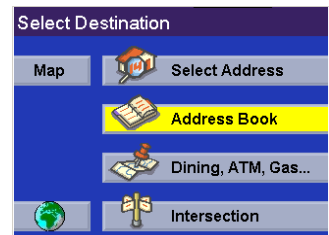

Select **List Addresses**.

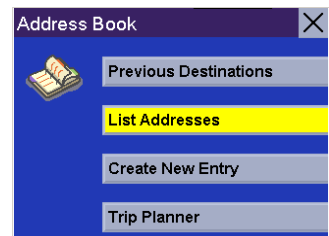

Selecting Destinations

Select **List Favorites**.

All of the addresses marked as favorites will be displayed.

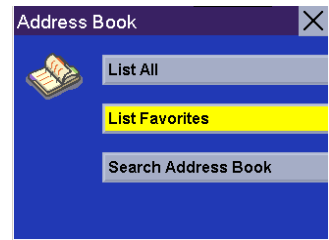

Route - Select **Route**.

Select the desired Route Method.

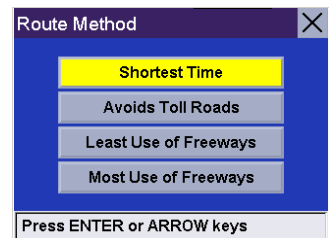
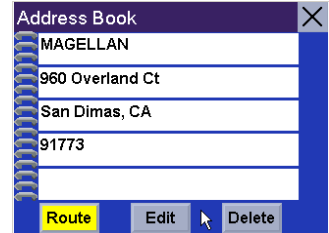

The Magellan RoadMate will calculate the route. When the calculations are complete, the Map screen will be displayed.

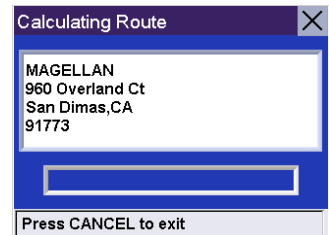

Edit - Select **Edit**.

Click on either the top line (name) or the bottom line (information) and the desired text.

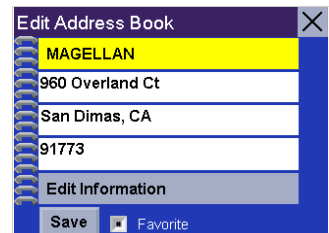
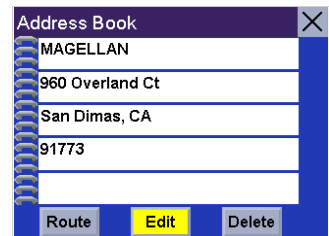

Selecting Destinations

Select **Save** to save the changes and return to the address screen.

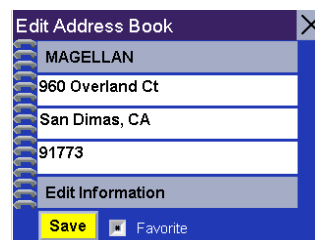

Delete - Select **Delete**.

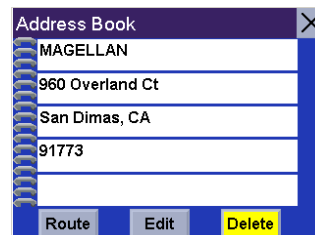

A dialog box will appear prompting you to confirm the deletion. Select **Yes**.

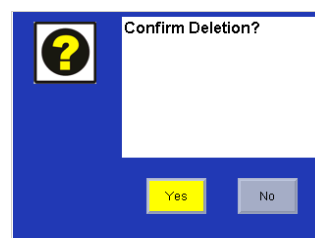

The address has been deleted from your address book and you are returned to the Select Destination screen.

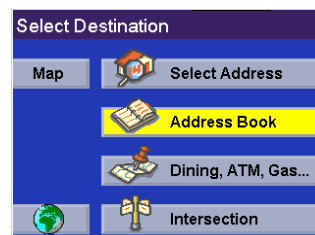

Search Address Book

From the Select Destination screen, select **Address Book**.

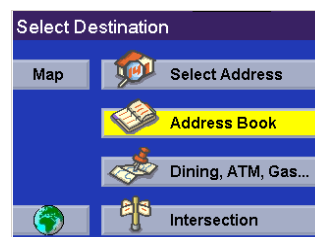

Select **List Addresses**.

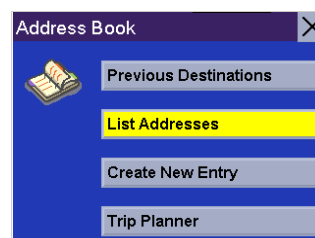

Selecting Destinations

Select **Search Address Book**.

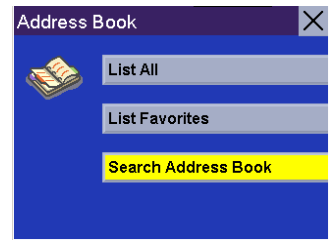

Enter the characters that may be part of the name you are searching for in your address book. When you have finished, select **OK**



A list of addresses matching your criteria is shown. Select the address you wish to use. You will then have the option of routing to, editing, or deleting this address.

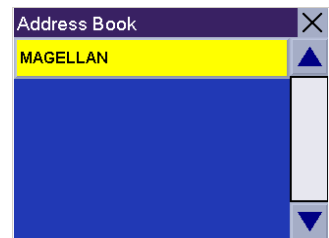

Route - Select **Route**.

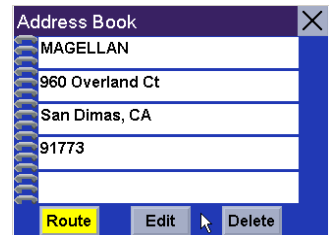

Select the desired Route Method.

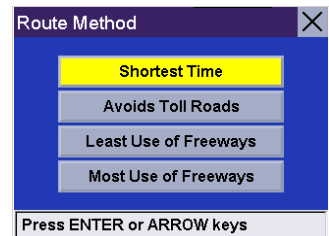

The Magellan RoadMate will calculate the route. When the calculations are complete, the Map screen will be displayed.

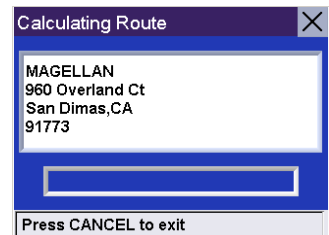

Selecting Destinations

Edit - Select **Edit**.

Click on either the top line (name) or the bottom line (information) and the desired text.

Select **Save** to save the changes and return to the address screen.

Delete - Select **Delete**.

A dialog box will appear prompting you to confirm the deletion. Select **Yes**. The address has been deleted and you are returned to the Address Book screen.

Create New Entry

Select on Map

From the Select Destination screen, select **Address Book**.

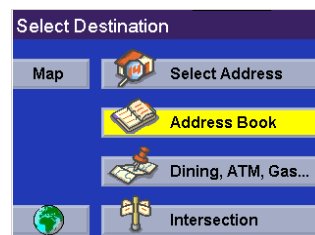
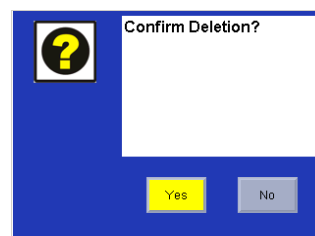
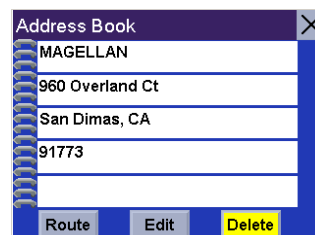
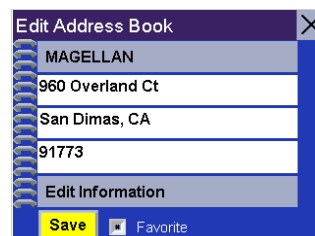
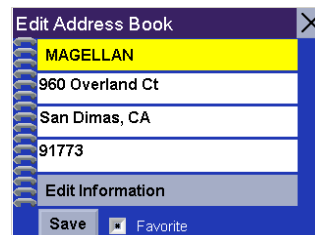
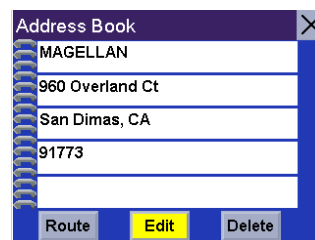

Selecting Destinations

Select **Create New Entry**.

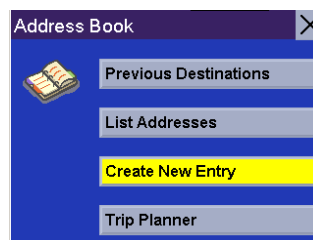

Select **Select on Map**.

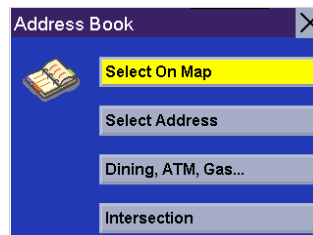

Touch the screen and drag the map to a point near to the desired address. Press the **Enter** key.

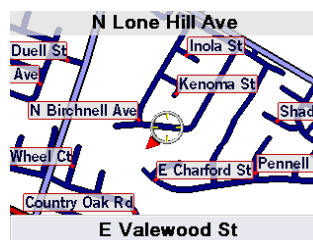

A dialog box will appear prompting you to edit the information. Select **Edit Name**.

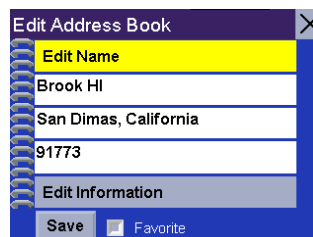

Enter a name for the address. When you are finished, select **OK**.

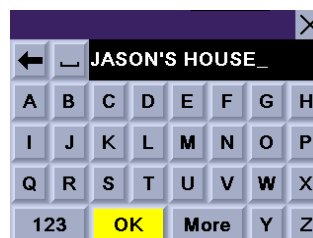

Select **Save**.

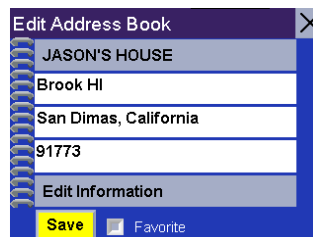

Selecting Destinations

The location is saved to your address book and you are returned to the map screen.

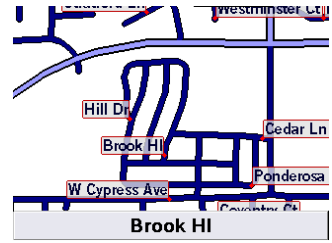

Press **Cancel** to resume normal routing.

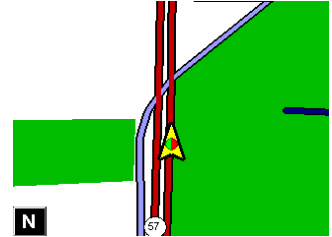

Select Address

From the Select Destination screen, select **Address Book**.

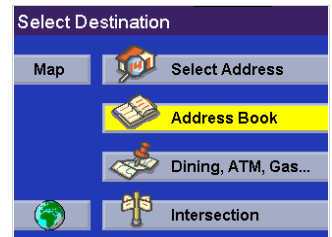

Select **Create New Entry**

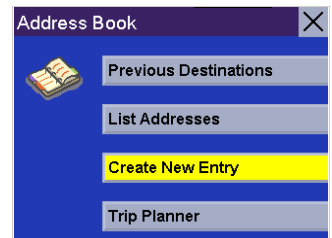

Select **Select Address**.

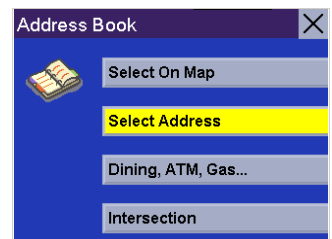

If more than one region is active, you will be asked to select the region from which to search.

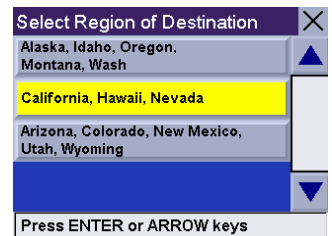

Selecting Destinations

Enter the base name for the street. For example, if you are searching for “Overland Court” you would enter “OVERLAND”. As you type, the AutoFill will show the next possible match from the database. Select **OK**. For additional help with entering street names, see “Help with Street Names” on page 13.



Next, if the street you are looking for is within two to five cities, select the desired city from the list. If the desired street is within more than six cities, you will need to narrow down your search further by entering the city name. Again, as you type, AutoFill will display the next possible match. Select **OK**.

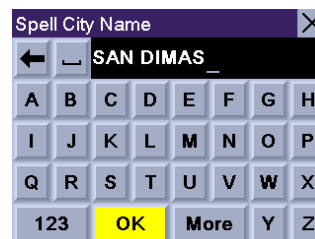

Enter the street address. The acceptable range of numbers is displayed at the top of the screen. If you do not know the exact address, just select **Done** and the Magellan RoadMate will route you to the lowest number in the range. When an acceptable street address has been entered, select **Done** to continue

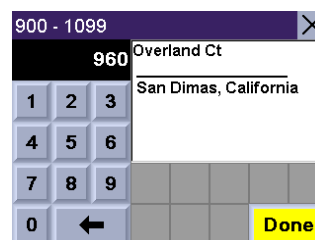

A dialog box will appear prompting you to edit the information. Select **Edit Name**.

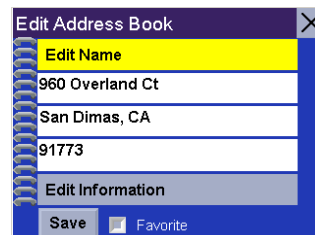

Enter a name for the address. When you are finished, select **OK**.



If you wish, you can select **Favorite** to add this address to your Favorites list. Select **Save**.

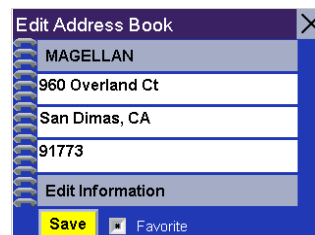

Selecting Destinations

You are returned to the Address Book screen.

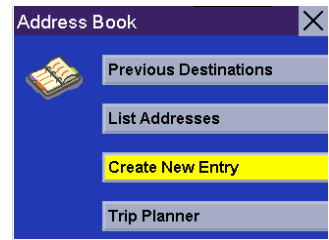

Dining, ATM, Gas...

From the Select Destination screen, select **Address Book**.

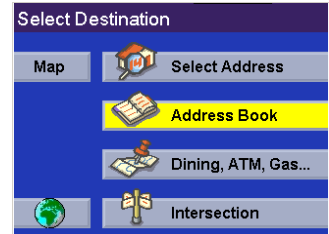

Select **Create New Entry**

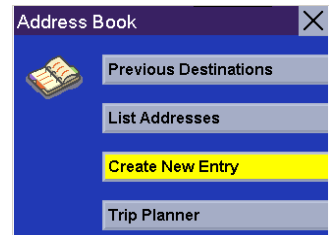

Select **Dining, ATM, Gas....**

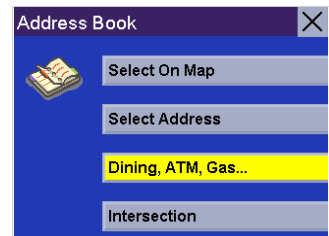

Search POI by Name - This function allows you to search for a specific point of interest and save it to your address book. Select **Search POI by Name**.

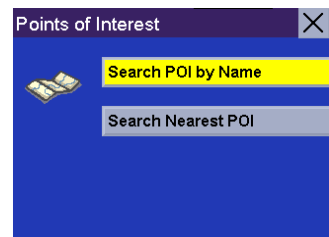

If more than one region is active, you will be asked to select the region from which to search.

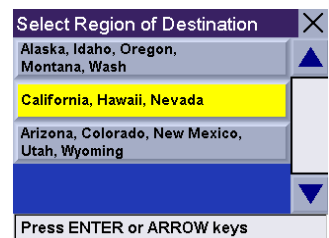

Selecting Destinations

Nearby Current Position. This function allows you to search for the named POI nearest to your present position starting with the closest. Select **Nearby Current Position**.

Select the POI category.

Enter the first few characters for the POI name. After you have selected the characters, select **OK**.

Use the navigation key to scroll the list up or down and select the desired POI.

A dialog box will appear prompting you to edit the information. You can choose to keep the default name. If you wish, you can select **Favorite** to add this address to your Favorites list. Select **Save**.

You are returned to the Address Book screen.

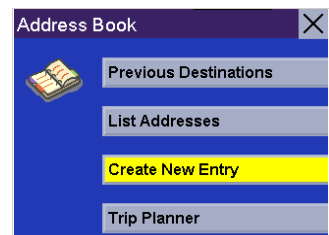
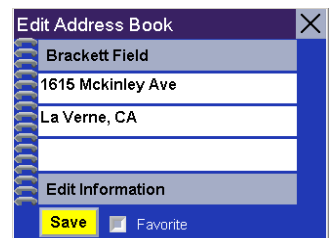
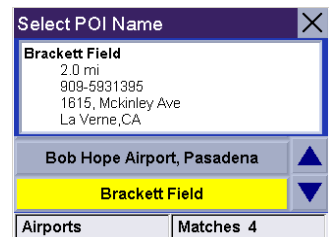
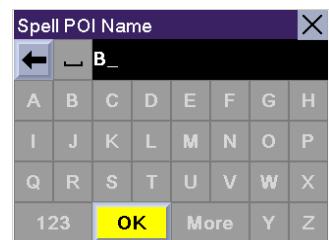
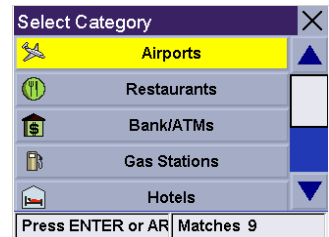
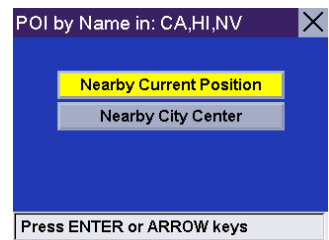

Selecting Destinations

Nearby City Center. This function allows you to search for the named POI closest to the geographical center of a city. Select **Nearby City Center**.

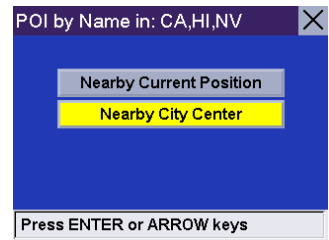

Enter the first few characters for the city name. After you have selected the characters, select **OK**.

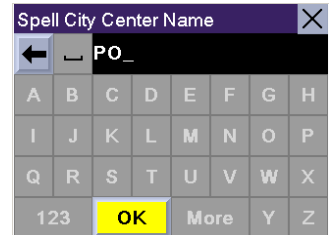

Select the POI category.

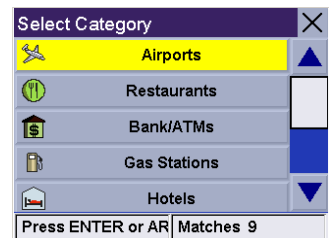

Enter the first few characters for the POI name. After you have selected the characters, select **OK**.

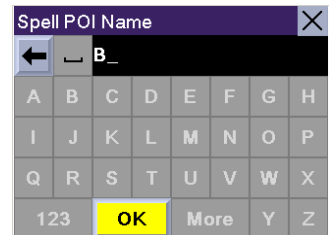

Use the navigation key to scroll the list up or down and select the desired POI.

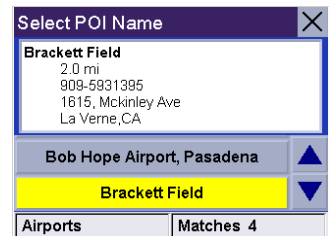

A dialog box will appear prompting you to edit the information. You can choose to keep the default name. If you wish, you can select **Favorite** to add this address to your Favorites list. Select **Save**.

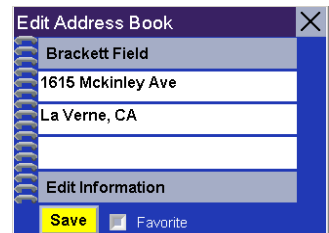

Selecting Destinations

You are returned to the Address Book screen.

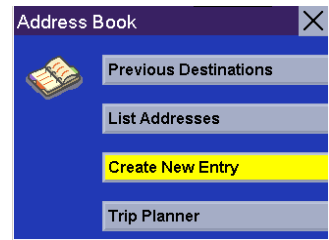

Search Nearest POI - This function lets you search for a point of interest from three criteria and save it to your address book: Current Position, By City Center, and By Airport. Select **Search Nearest POI**.

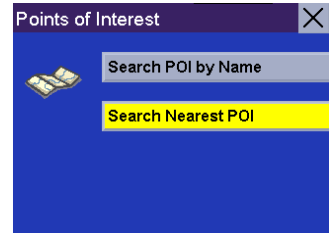

If more than one region is active, you will be asked to select the region from which to search.

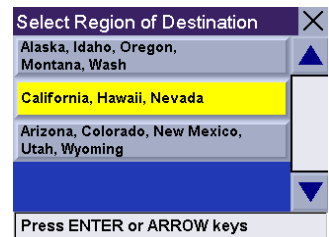

Current Position. This option lets you find a specific point of interest based on where you are at the time. Select **Current Position**.

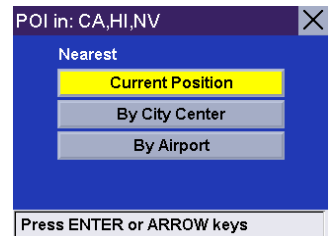

Select the POI category (if available, select the sub-category).

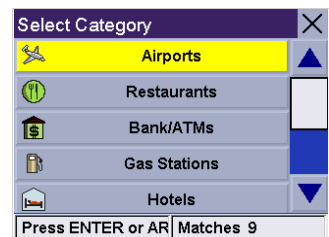

Use the navigation key to scroll the list up or down and select the desired POI.

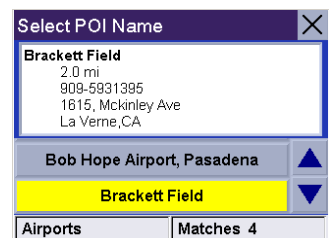

Selecting Destinations

A dialog box will appear prompting you to edit the information. You can choose to keep the default name. If you wish, you can select **Favorite** to add this address to your Favorites list. Select **Save**.

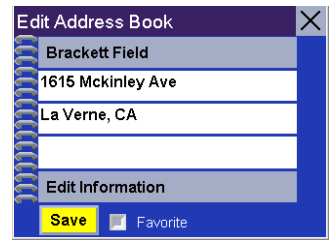

You are returned to the Address Book screen.

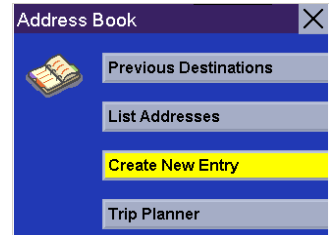

By City Center. This option lets you find a specific point of interest closest to a chosen city center. Select **By City Center**.

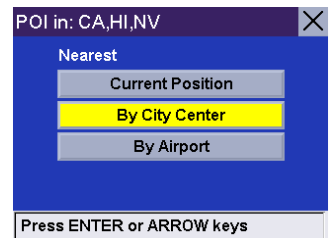

Enter the first few characters for the city name. After you have selected the characters, select **OK**.

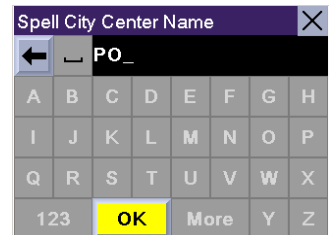

Use the navigation key to scroll the list up or down and select the desired city.

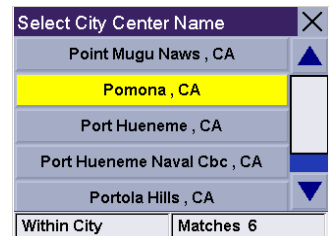

Select the POI category (if available, select the sub-category).

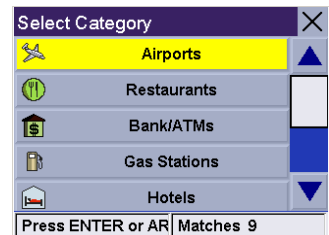

Selecting Destinations

Use the navigation key to scroll the list up or down and select the desired POI.

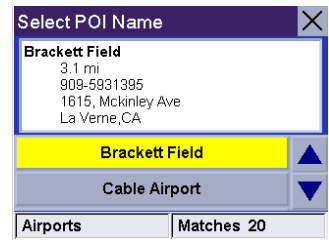

A dialog box will appear prompting you to edit the information. You can choose to keep the default name. If you wish, you can select **Favorite** to add this address to your Favorites list. Select **Save**.

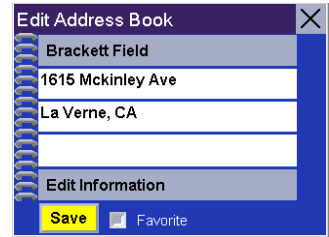

You are returned to the Address Book screen.

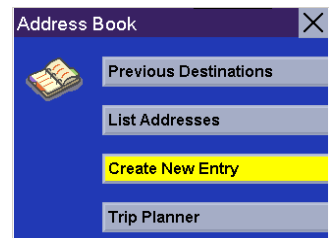

By Airport. This option lets you find a specific point of interest closest to a chosen airport. Select **By Airport**.

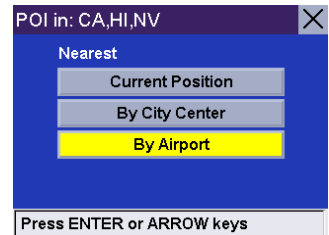

Enter the first few characters for the Airport name. After you have selected the characters, select **OK**.

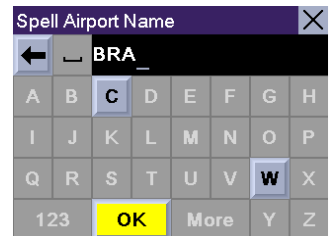

Use the navigation key to scroll the list up or down and select the desired Airport.

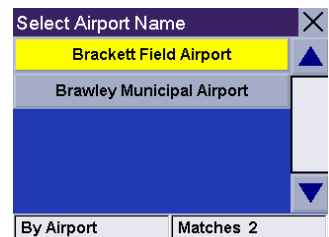

Selecting Destinations

Select the POI category (if available, select the sub-category).

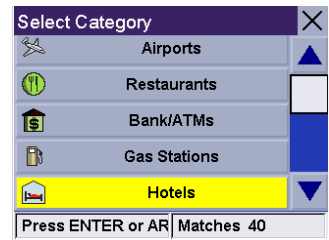

A list of available POIs that match your criteria is shown. Use the navigation key to scroll the list up or down and select the desired POI.



A dialog box will appear prompting you to edit the information. You can choose to keep the default name. If you wish, you can select **Favorite** to add this address to your Favorites list. Select **Save**.

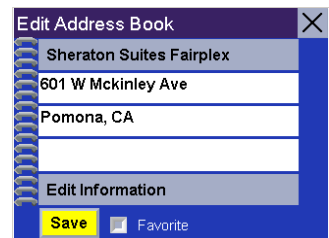

You are returned to the Address Book screen.

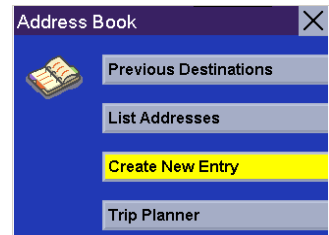

Intersection

From the Select Destination screen, select **Address Book**.

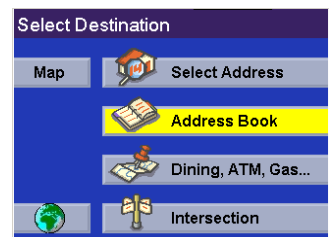

Select **Create New Entry**

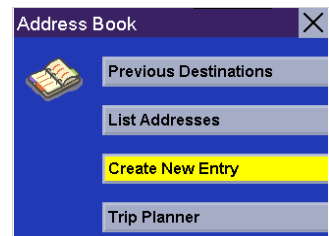

Selecting Destinations

Select **Intersection**.

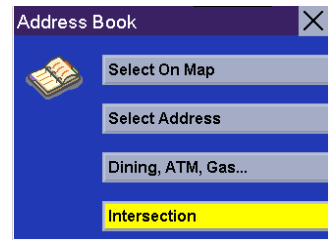

If more than one region is active, you will be asked to select the region from which to search.

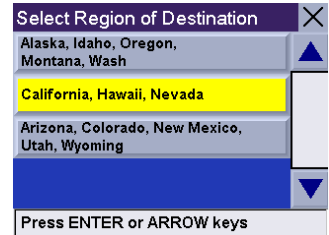

Enter the first few characters for the first street. After you have selected the characters, select **OK**.



Use the navigation key to scroll the list up or down and select the desired street.

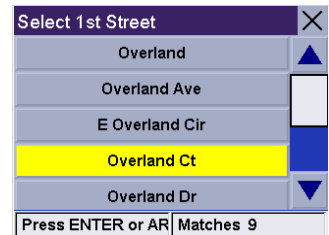

Select the city that the street is in. If the selected street is located in only one city, this screen will not appear.

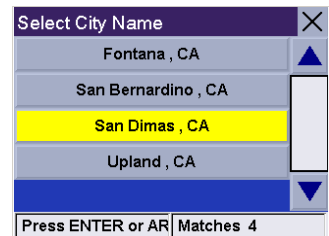

Enter the first few characters for the second street. After you have selected the characters, select **OK**.

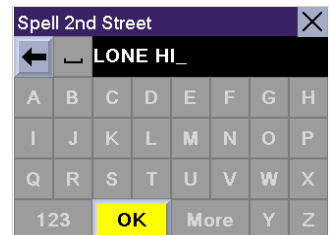

Selecting Destinations

Use the navigation key to scroll the list up or down and select the desired street. It is possible to select a non-intersecting street. In that case, a warning screen will appear. Press **Cancel** to go back and re-enter the street name.

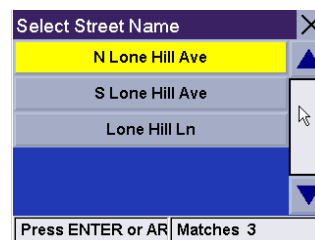

Click on either the top line (name) or the bottom line (information) and enter the desired text.

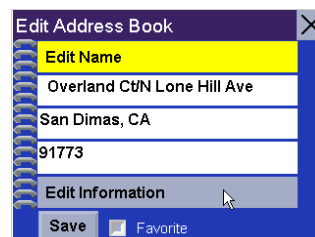

Select Save to save the changes and return to the Address Book screen.

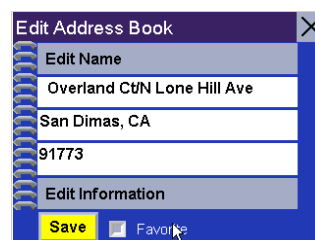

Trip Planner

The Trip Planner enables you to plot multiple destinations and save them as a trip. This feature is useful when planning a vacation, making deliveries, or running errands. Each user can define up to 20 trips with 20 destinations each. Each different destination will be saved in the address book. Note however, that only 200 addresses can be saved per user.

New

You can create trips from addresses stored in your address book.

From the Select Destination screen, select **Address Book**.

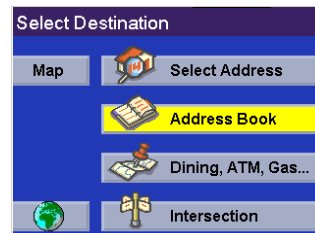

Select **Trip Planner**

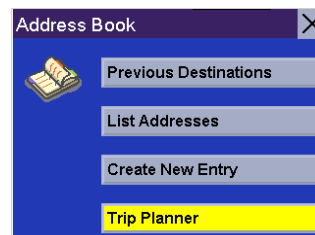

Selecting Destinations

Select **New**.

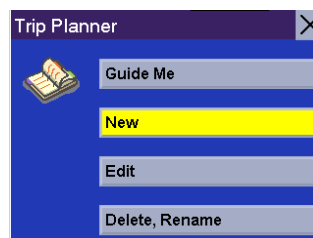

Enter a name for the trip and select **OK**



Your trip name will be displayed, followed by your address list.



Select the addresses you wish to use in your trip in the order you wish them to be listed. When you have finished, select **Done: [trip name]**.



You will be taken back to the Trip Planner screen. At this point you can choose to route to your new trip.



Press **Guide Me**.



Selecting Destinations

Select the trip you created.

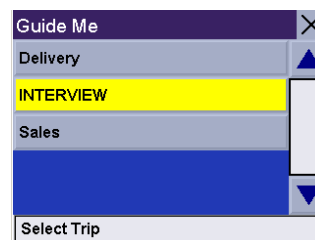

Select the first point of the trip you wish to route to.

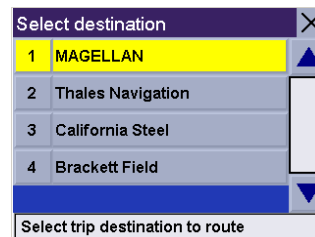

Select the desired Route Method.

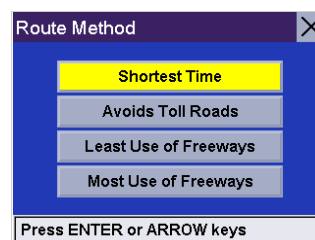

The Magellan RoadMate will calculate the route. When the calculations are complete, the Map screen will be displayed. When you arrive at your first point the Magellan RoadMate will notify you. Selecting **Cancel** or, if you turn off your car and turn it back on, the Magellan RoadMate will ask you to resume trip guidance. Select **Resume** to be routed to the next address in your trip. Select **Cancel** to stop trip guidance.

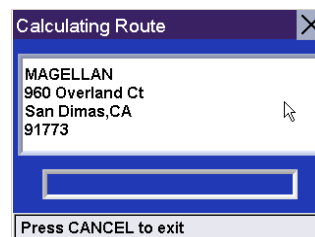

Edit

Editing your trip allows you to add, delete, or change the order of the points in your trip.

From the Select Destination screen, select **Address Book**.

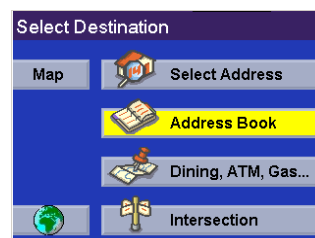

Select **Trip Planner**

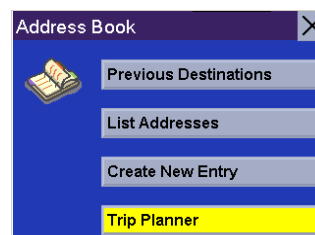

Selecting Destinations

Select **Edit**.

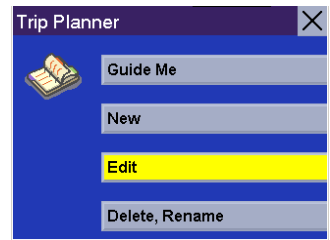

Select the Trip you wish to edit.

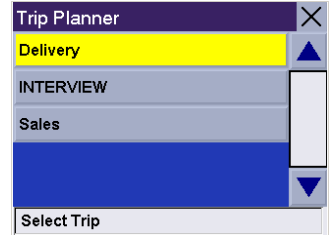

Select any of the points of the trip. A submenu will appear giving you the option of adding another point to your trip, moving the selected point up or down, or deleting the selected point.

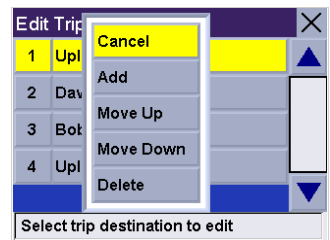

When you are finished making changes, press the **Cancel** button to return to the Trip Planner screen.

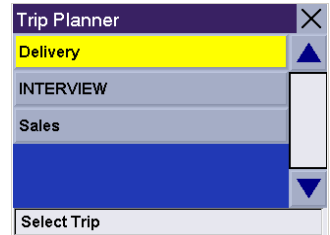

Delete, Rename

From the Select Destination screen, select **Address Book**.

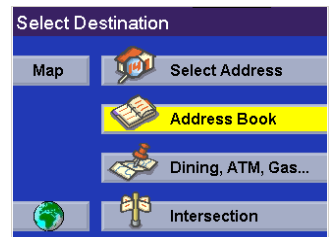

Select **Trip Planner**.

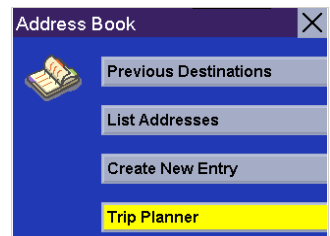

Selecting Destinations

Select **Delete**, **Rename**.

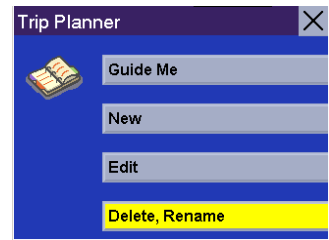

Delete - Select **Delete**.

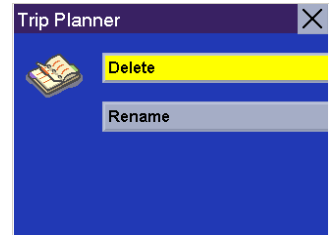

Select the trip you wish to delete.

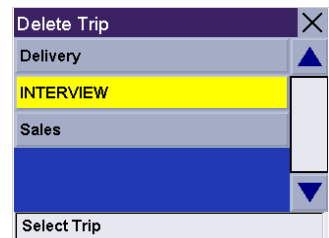

A dialog box will appear prompting you to confirm your selection. Select **Yes**.

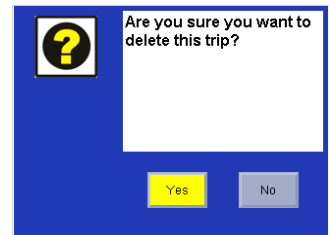

The trip has been deleted.

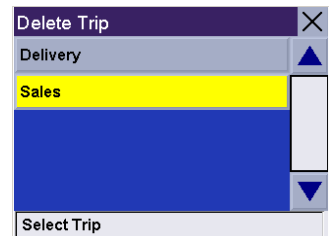

Rename - Select **Rename**.

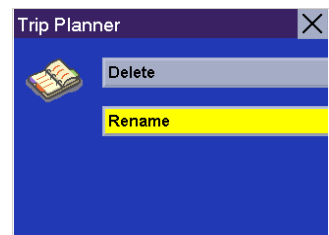

Selecting Destinations

Select the trip you wish to rename.

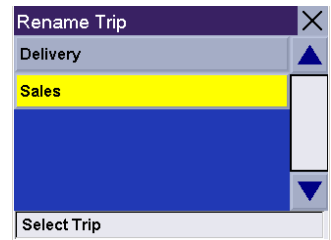

Use the backspace key to erase the name, then enter the new name. When you are finished, select **OK**.

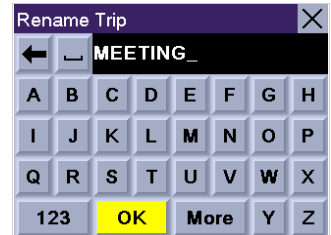

The trip has been renamed.

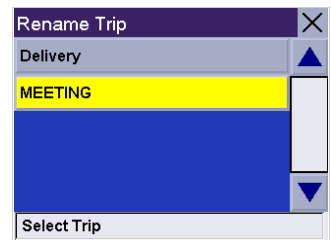

Selecting Destinations

Selecting a Destination Using “Dining, ATM, Gas...”

Points of Interest (commonly referred to as POIs), include businesses, recreation areas, landmarks, or other services. These range from restaurants, parks, and gas stations, to hotels and city centers. The purpose of the POI database (accessed through the “Dining, ATM, Gas...” menu option) is to provide you a list of popular destinations that you might be interested in going to, without having to add them to your address book manually. These POIs are very useful while traveling in an unfamiliar city.

Search POI by Name

From the Select Destination screen, select **Dining, ATM, Gas....**



Select **Search POI by Name**.

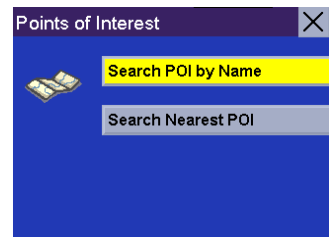

If more than one region is active, you will be asked to select the region from which to search.

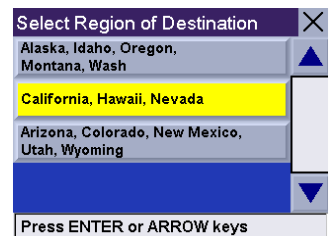

Nearby Current Position

This function allows you to search for the named POI nearest to your present position starting with the closest. Select **Nearby Current Position**.

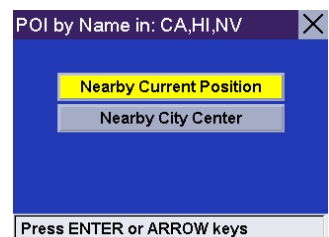

Select the POI category.

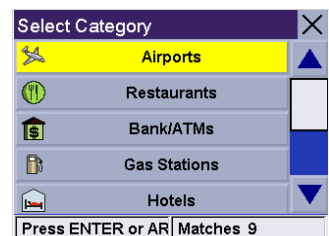

Selecting Destinations

Enter the first few characters for the POI name. After you have selected the characters, select **OK**.

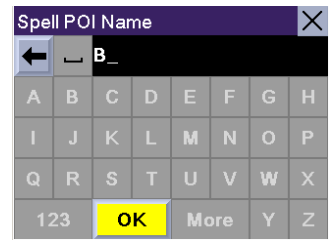

Use the navigation key to scroll the list up or down and select the desired POI.

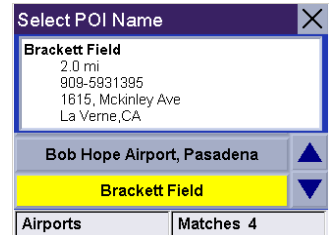

Select the desired Route Method.

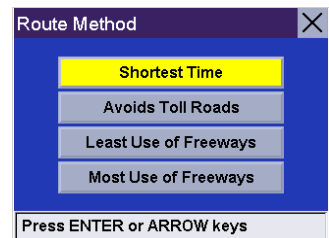

The Magellan RoadMate will calculate the route. When the calculations are complete, the Map screen will be displayed

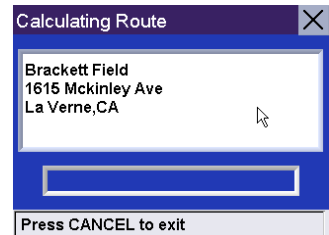

Nearby City Center

This function allows you to search for the named POI closest to the geographical center of a city. Select **Nearby City Center**.

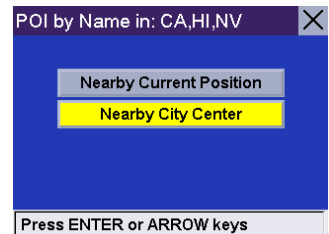

Enter the first few characters for the city name. After you have selected the characters, select **OK**.

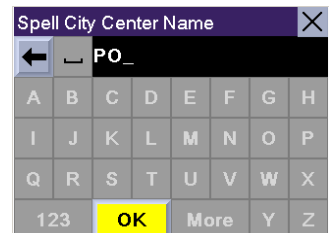

Selecting Destinations

Select the POI category.

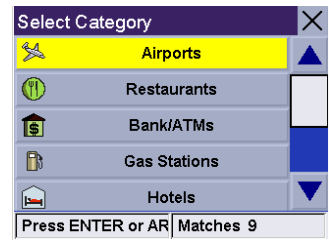

Enter the first few characters for the POI name. After you have selected the characters, select **OK**.

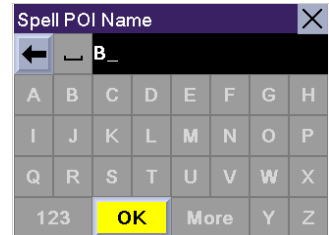

Use the navigation key to scroll the list up or down and select the desired POI.

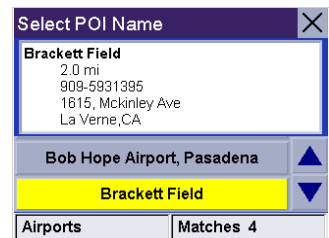

Select the desired Route Method.

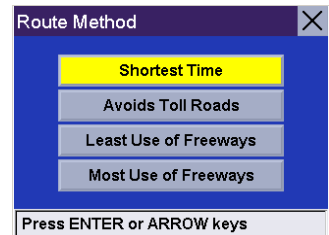

The Magellan RoadMate will calculate the route. When the calculations are complete, the Map screen will be displayed

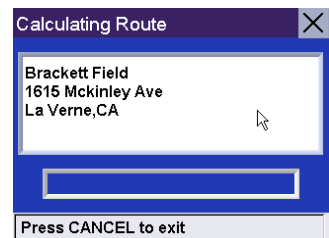

Search Nearest POI

Select **Dining, ATM, Gas....**

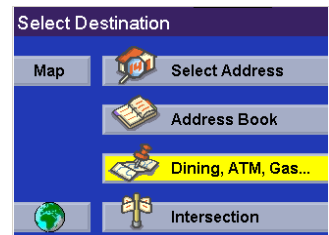

Selecting Destinations

Select **Search Nearest POI**.

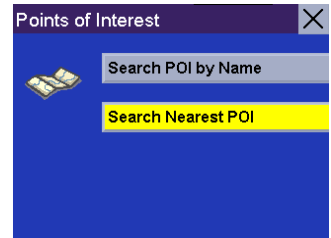

If more than one region is active, you will be asked to select the region from which to search.

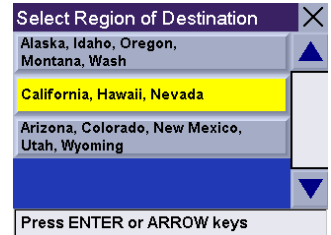

Current Position

This option lets you route to a specific point of interest based on where you are at the time. From the Select **Current Position**.

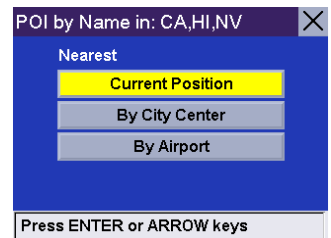

Select the POI category (if available, select the sub-category).

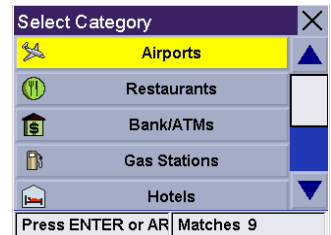

Use the navigation key to scroll the list up or down and select the desired POI.

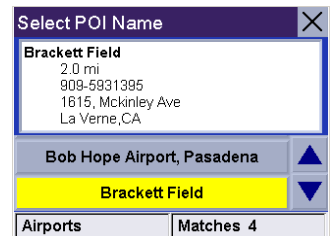

Select the desired Route Method.

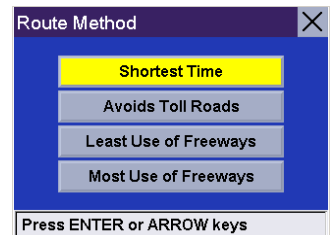

Selecting Destinations

The Magellan RoadMate will calculate the route. When the calculations are complete, the Map screen will be displayed

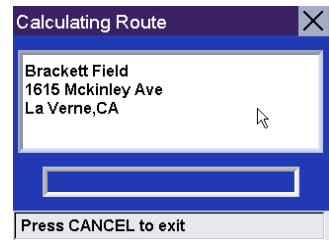

By City Center

This option lets you route to a specific point of interest closest to a chosen city center. Select **By City Center**.

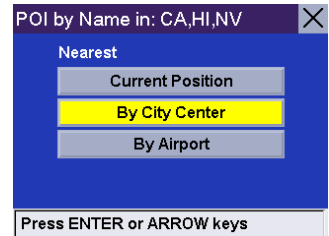

Enter the first few characters for the city name. After you have selected the characters, select **OK**. If you wish, you may enter the entire city name.

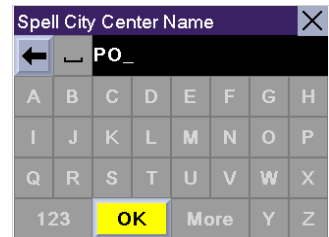

Use the navigation key to scroll the list up or down and select the desired city.

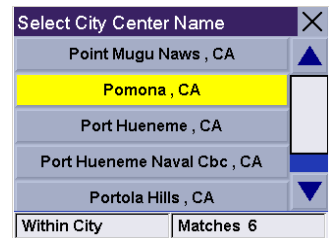

Select the POI category (if available, select the sub-category).

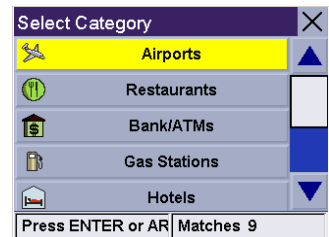

Use the navigation key to scroll the list up or down and select the desired POI.

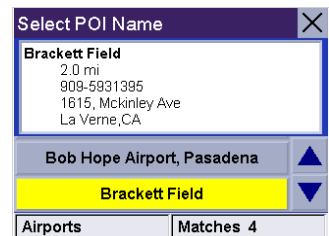

Selecting Destinations

Select the desired Route Method.

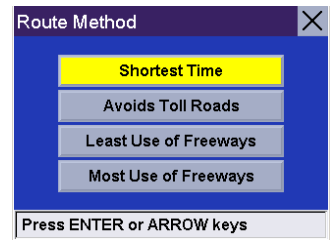

The Magellan RoadMate will calculate the route. When the calculations are complete, the Map screen will be displayed

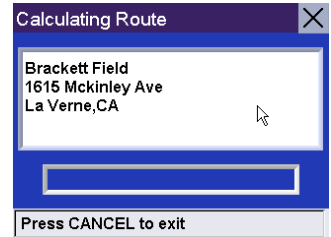

By Airport

This option lets you route to a specific point of interest closest to a chosen airport. From the Select **By Airport**.

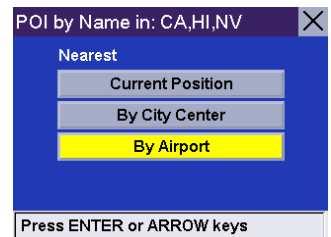

Enter the first few characters for the Airport name. After you have selected the characters, select **OK**. If you wish, you may enter the entire Airport name.



Use the navigation key to scroll the list up or down and select the desired Airport.

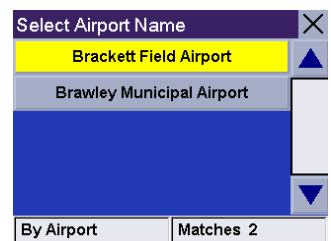

Select the POI category (if available, select the sub-category).

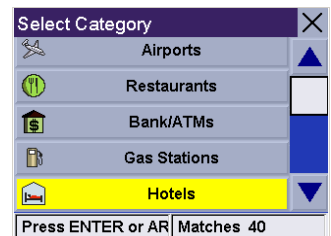

Selecting Destinations

A list of available POIs that match your criteria is shown. Use the navigation key to scroll the list up or down and select the desired POI.

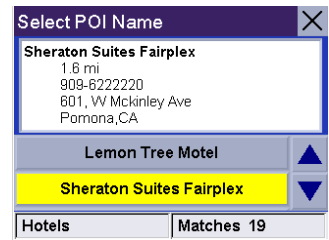

Select the desired Route Method.

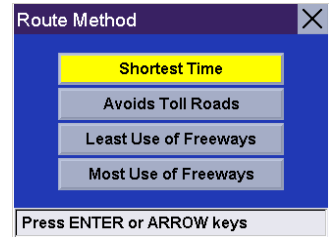

The Magellan RoadMate will calculate the route. When the calculations are complete, the Map screen will be displayed

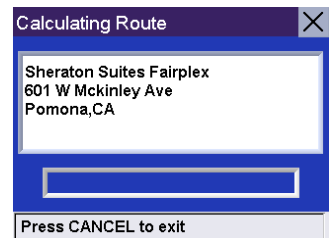

Selecting a POI on the Map

While viewing the Map screen, you can select a POI icon and be routed to it, or save it to you address book.

Touch the POI on the screen.



A dialog box will appear giving you information on the POI. Select **Route**.

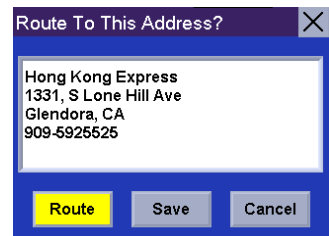

Select the desired Route Method.

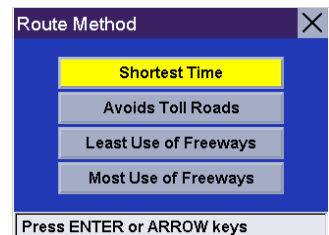

Selecting Destinations

The Magellan RoadMate will calculate the route. When the calculations are complete, the Map screen will be displayed

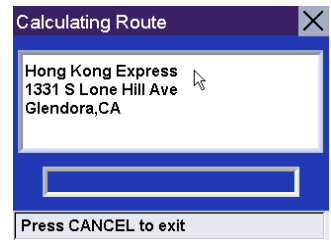

Selecting Destinations

Selecting a Destination Using “Intersection”

Intersections are very common markers for routing when you don't know the actual address. The Magellan RoadMate can route you to an intersection of two streets contained within the active detailed map.

From the Select Destination screen, select **Intersection**.



If more than one region is active, you will be asked to select the region from which to search.

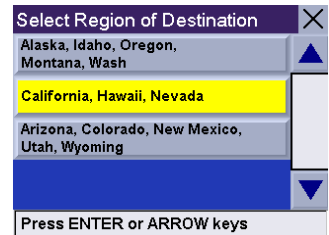

Enter the first few characters for the first street. After you have selected the characters, select **OK**.



Use the navigation key to scroll the list up or down and select the desired street.

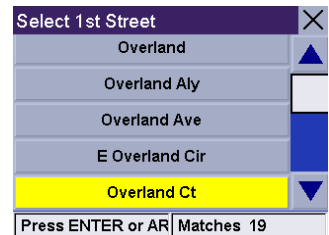

Select the city that the street is in. If the street is in only one city, this screen will not appear.

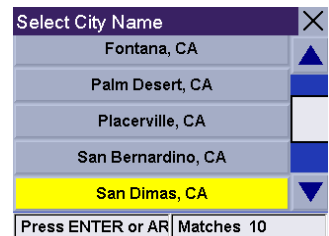

Enter the first few characters for the second street. After you have selected the characters, select **OK**. It is possible to enter a non-intersecting street. In that case, a warning screen will appear. Press the **Cancel** key to go back and re-enter the street name.

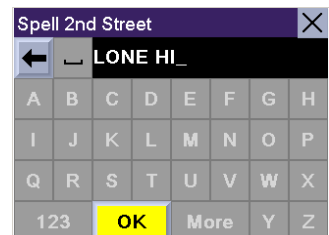

Selecting Destinations

Use the navigation key to scroll the list up or down and select the desired street.

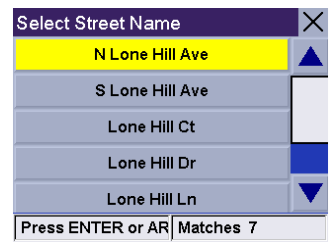

Select the desired Route Method.

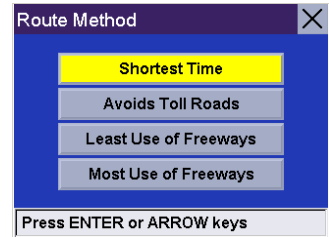

The Magellan RoadMate will calculate the route. When the calculations are complete, the Map screen will be displayed

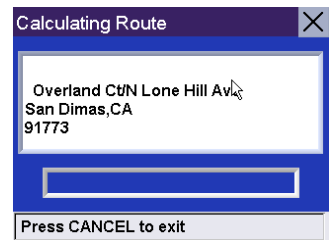

Traveling

Guidance Information Screens

The Magellan RoadMate has three screens you can use to assist you in traveling to your destination: the Map screen, the Maneuver List screen, and the TrueView (or Split TrueView) screen.

The Map Screen — This screen displays a map of your surrounding area, along with the planned route (if calculated) and information about the route. This screen also displays your direction of travel. This screen can be accessed when you have no route by selecting the Map button on the Select Destination screen or by pressing the View or Cancel key while viewing the Select Destination screen.

The Maneuver List Screen — This screen is available only when a route has been calculated. This screen displays a list of each maneuver along the calculated route to your destination. To access the Maneuver List screen, press the View button while viewing the Map screen.

The TrueView/Split TrueView Screen — This screen is available only when a route has been calculated. This screen displays the next maneuver as a graphic. In Split TrueView mode (see page 76), the TrueView maneuver is displayed on the left side of the screen with the map displayed on the right. To access the TrueView screen, press the **View** button while viewing the Maneuver List.

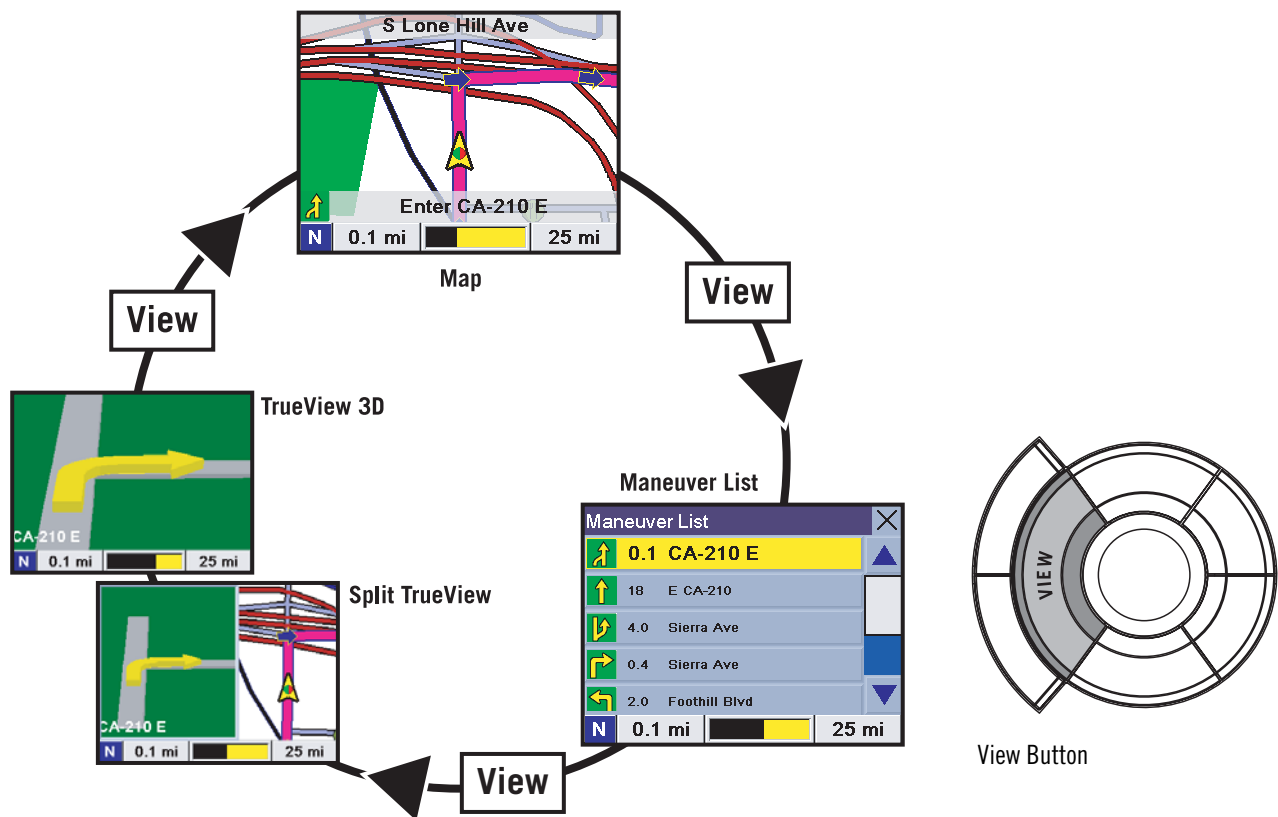

Traveling

Map Screen

The Map screen is the most commonly used screen in the Magellan RoadMate. It provides you with detailed information about where you are and where you are going.

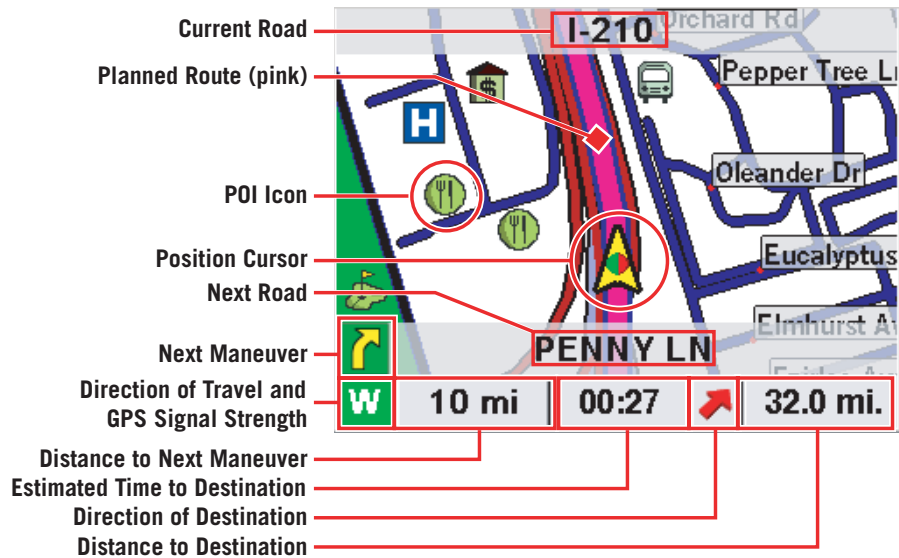

As you travel, the Map screen constantly updates your location. It provides you with not only a map but also a visual indication of where you are on the map.

If the Magellan RoadMate loses the satellite signal for more than 15 seconds and is unable to compute your location, the display will automatically switch to the Maneuver List screen. This will give you the information needed for your next maneuver. While viewing the map screen, touching a POI icon will give you the option of routing to that point. See "Selecting a POI on the Map" on page 55.

Changing the Map Zoom Levels

While in the Map screen, you can zoom in on (enlarge) the map or zoom out from (shrink) the map. The zoom levels range from 130 ft. to 1665 mi.

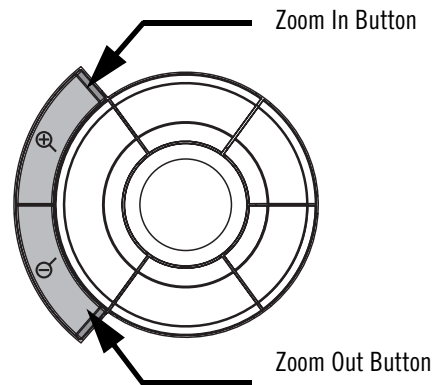

Traveling

Maneuver List Screen

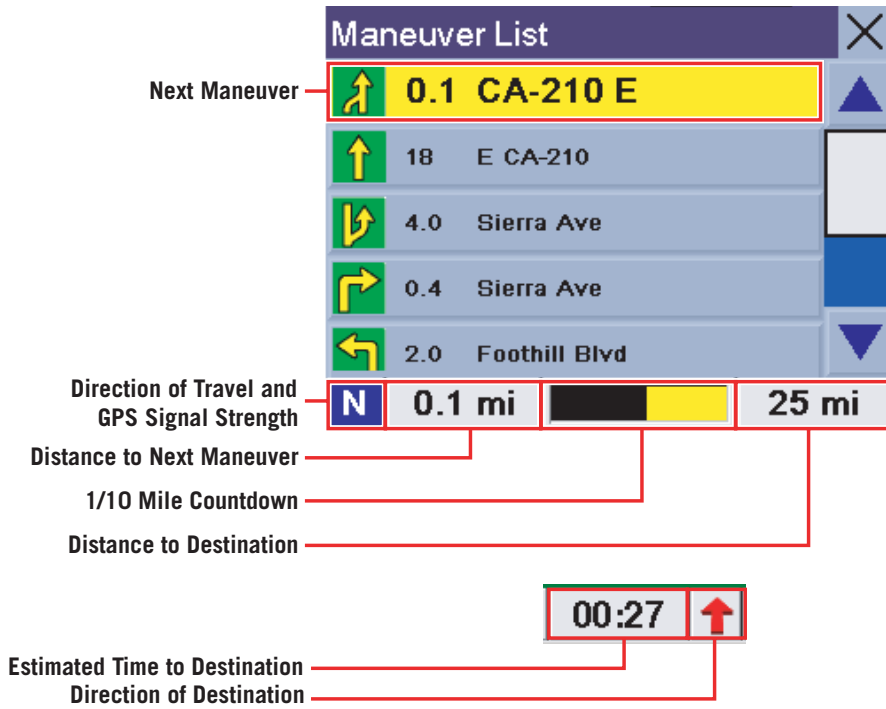

TrueView Screen

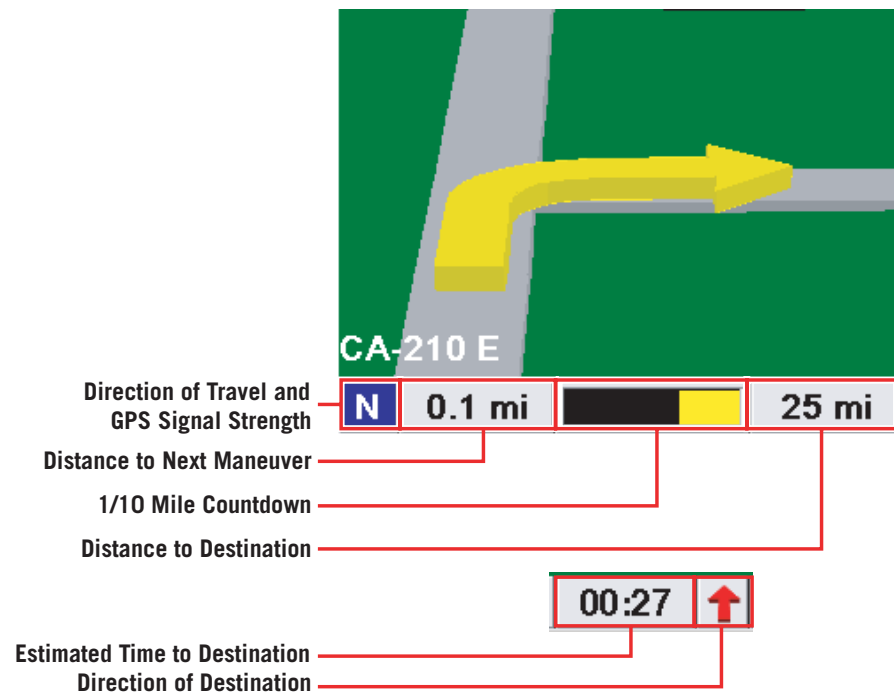

Traveling

Current Location

Displaying Information About Your Current Location

Whenever you want to view information about your present location you can press the **Locate** button.

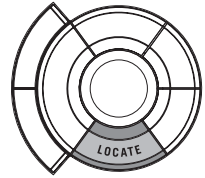

This screen displays the name of the street you are currently traveling on, the city and state, your current heading, speed and latitude and longitude coordinates. It also displays the distance to and name of the next street, and the distance from and name of the previous street.

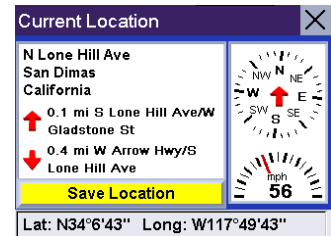

Save Location

If you are traveling and you wish to save a location that is not in the database, say a photo spot or a fishing spot, you can save it to your address book. Press the **Locate** button.

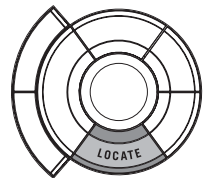

Select **Save Location**.

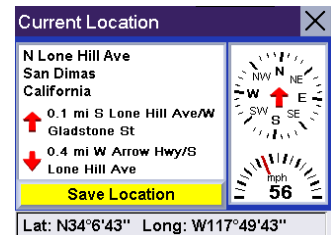

Select **Edit Name**.

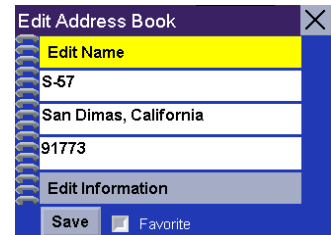

Edit the name of the location. Select **OK**.

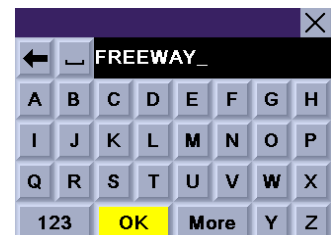

Select **Save**. The address is saved to your address book and you are returned to the last viewed screen.

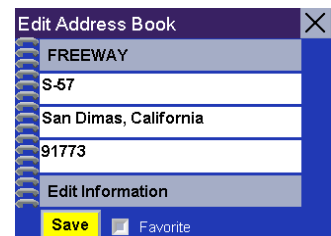

User Options

User Option Menu

User Options enable you to customize the Magellan RoadMate and take advantage of its data recording capabilities. User Options can be accessed from any screen by pressing the **Option** button.

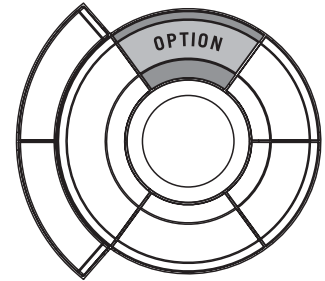

The User Options section of Magellan RoadMate provides you with four options:

Trip Computer – Displays useful information about your trip such as mileage, that can be saved for future reference. Ideal for the business traveler who needs to record mileage and time spent on the road.

Track Recorder – Records a graphical representation of where you've been that you can save and view on the Magellan RoadMate screen.

Configuration – Lets you change the audio, video, language, and power option settings of the Magellan RoadMate.

User Settings – Lets you further customize the Magellan RoadMate.

User Options

Trip Computer

The Trip Computer is a valuable tool for recording the mileage and time spent driving while on vacation or on a business trip. The information for the trip can be saved to the Magellan RoadMate as a report and viewed at any time, giving you easy access to previous and current trip information.

When you begin a new trip and you need to record the information, access the Trip Computer. There, you can save the information displayed for the current trip (if needed) and reset the Trip Computer to zero in preparation for your new trip.

Press the **Option** button and select **Trip Computer**.

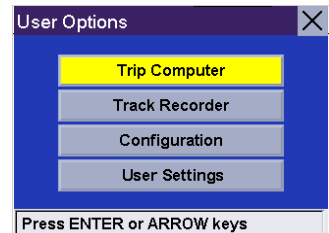

Select **Current**.

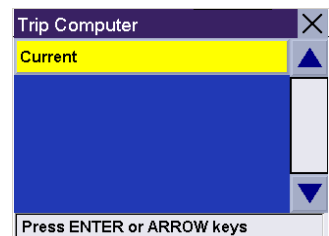

The data for the current trip is displayed. By default, the trip will be running and recording data from the first time it is turned on. From this screen, the Trip Computer can be restarted, stopped, reset or saved.

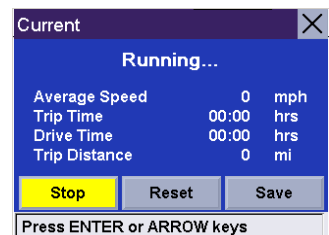

Stopping or Starting the Trip Computer

Select **Stop** to stop the current trip.

Select **Start** to resume the current trip.

The top of the display will show "Running..." or "Stopped," depending on the current status of the Trip Computer.

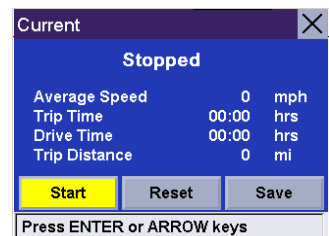

Saving the Current Trip Report

Select **Save**.

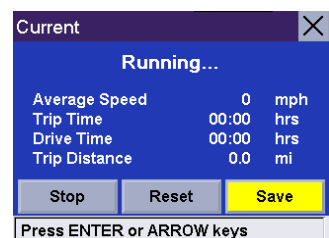

User Options

Use the keypad to enter a name for the saved Trip Report and select **OK**.



Your trip is saved and you are returned to the current trip screen.

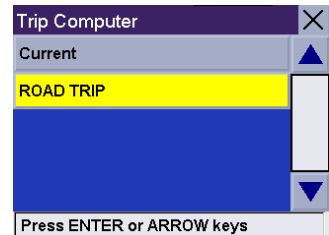

Resetting the Trip Computer

Select **Reset**. The values for the Trip Computer will be set to zero. Resetting the Trip Computer will also set the status of the computer to “Running...” if it had been stopped previously.

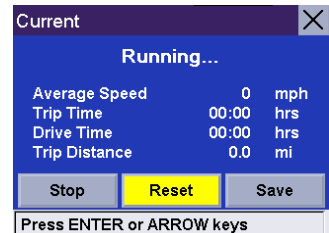

Viewing a Saved Trip Report

From any screen, press the **Option** button. Select **Trip Computer**.

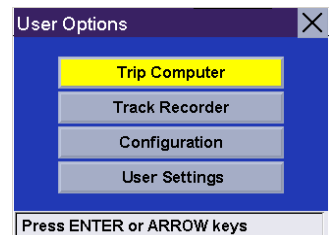

Select the Trip Report to be viewed.

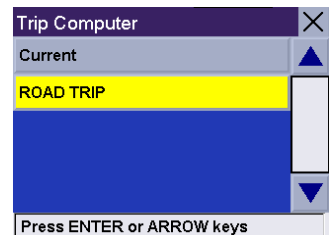

The saved Trip Report is displayed. When you are done viewing the saved Trip Report, you can press **Cancel** twice to be returned to the User Options screen.

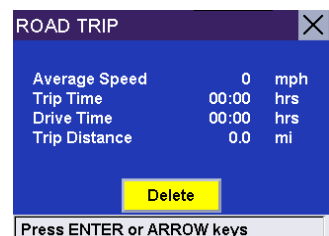

User Options

Deleting a Trip Report

From any screen, press the **Option** button. Select **Trip Computer**.

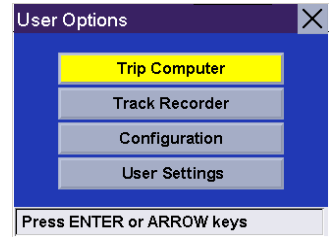

Select the Trip Report to be deleted.

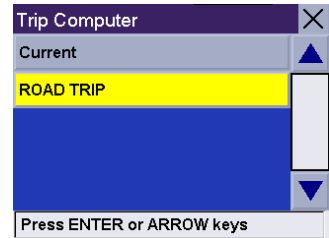

The details of the Trip Report are displayed. Select **Delete**.

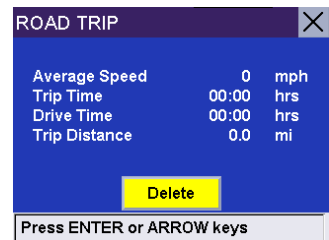

Select **Yes** to confirm.

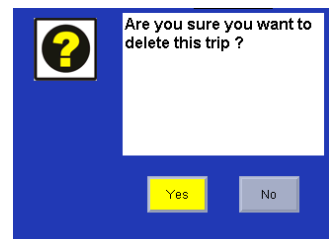

The Trip Report is deleted, and you are returned to the Trip Computer screen.

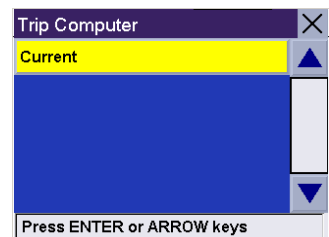

User Options

Track Recorder

The Track Recorder is useful if you wish to keep a record of a route you have taken to a particular place. You can record up to 30 tracks on your unit with 2,000 track points each.

Start Track Recorder

From any screen, press the **Option** button and select **Track Recorder**.

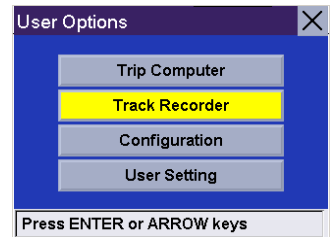

Select **Start** to begin recording a new track.

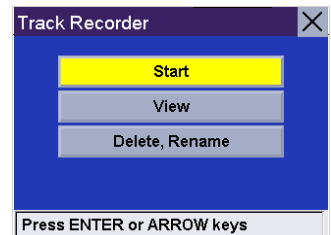

The Magellan RoadMate will begin recording. At this point you can return to the Map screen by pressing the **Cancel** button and continue driving normally.

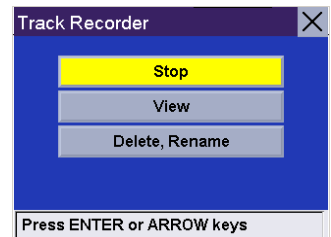

Stop Track Recorder

From any screen press the **Option** button and select **Track Recorder**.

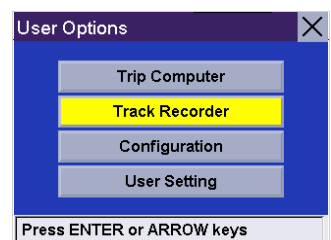

Select **Stop**.

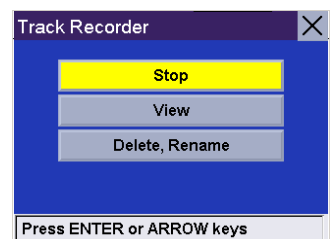

User Options

A dialog box will appear asking you if you wish to stop the track and save it, stop the track and not save it, or resume recording the track. Select **No**.

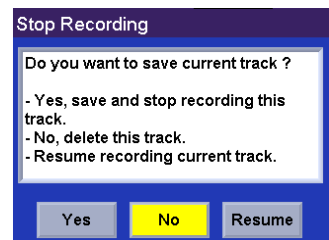

The track recorder is stopped and you are returned to the Track Recorder screen.

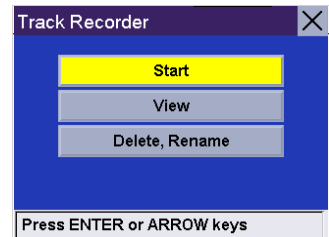

Save Track Record

From any screen press the **Option** button and select **Track Recorder**.

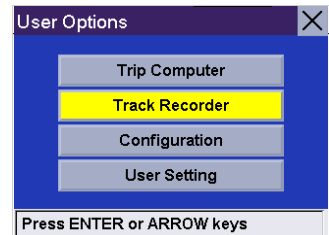

Select **Stop**.

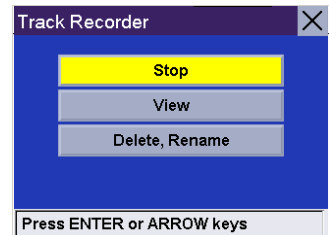

A dialog box will appear asking you if you wish to stop the track and save it, stop the track and not save it, or resume recording the track. Select **Yes**.

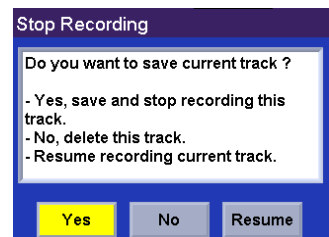

You will be prompted to enter a name for your track. When you are finished, select **OK**.



User Options

You are returned to the Track Recorder screen.

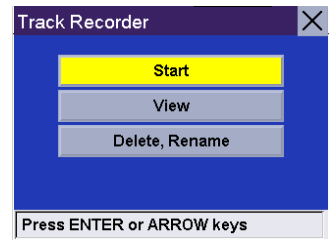

View Track

From any screen press the **Option** button and select **Track Recorder**.

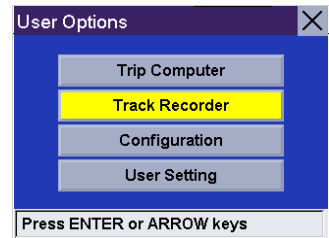

Select **View**.

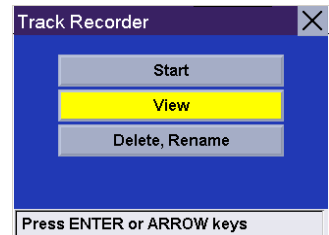

Select the track you wish to view from the list.

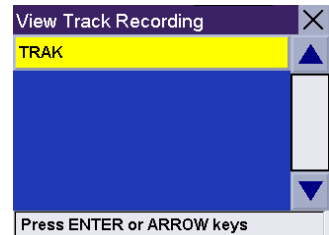

The track will be displayed. When you are finished viewing the track, press the **Cancel** button.

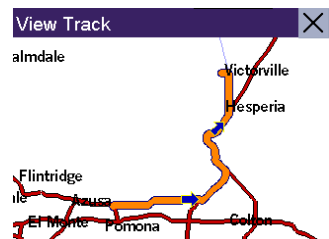

You are returned to the Track Recorder screen.

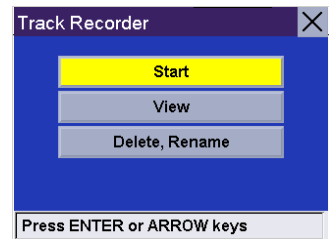

User Options

Delete, Rename Track

From any screen press the **Option** button and select **Track Recorder**.

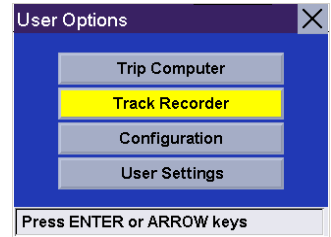

Select **Delete, Rename**.

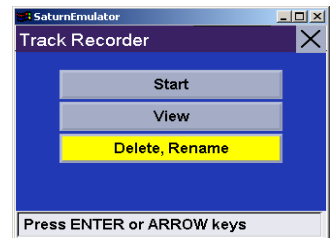

Delete

Select **Delete**.

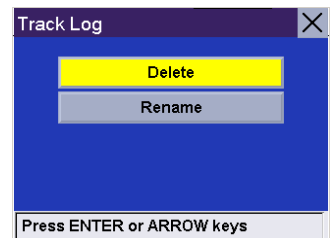

Select the track you wish to delete.

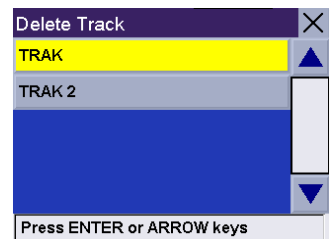

A dialog box will appear asking you to confirm your request. Select **Yes**.



The track is deleted.

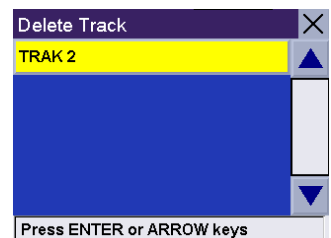

User Options

Rename

Select **Rename**.

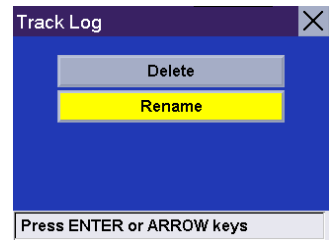

Select the name of the track you wish to rename.

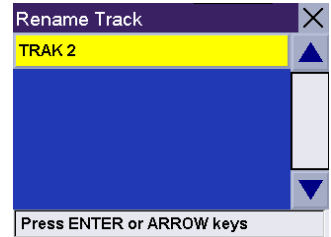

Use the backspace key to erase the old name and enter the new name. Select **OK**.

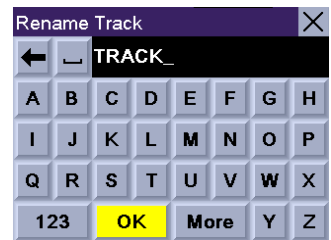

The track has been renamed.

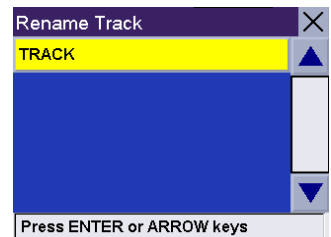

User Options

Configuration

The Configuration menu lets you adjust the visual and audio settings of the Magellan RoadMate.

From any screen, press the **Option** button. Select **Configuration**.

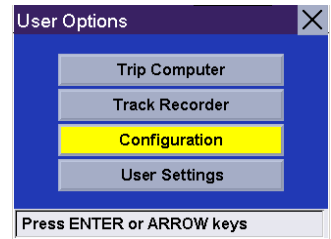

Brightness

Select "Brightness".

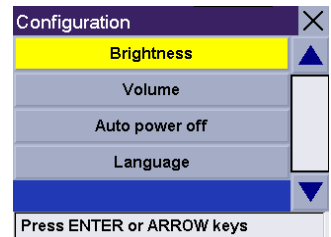

Press right arrow to increase the brightness, press the left arrow to decrease the brightness. When you are finished, select **Save**.

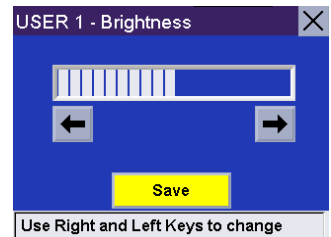

Volume

Select **Volume**.

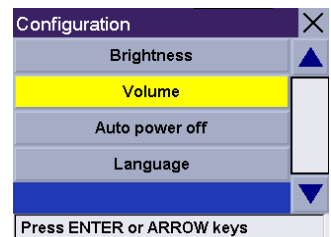

Press the right arrow to increase the volume, press the left arrow to decrease the volume. When you are finished, select **Save**.

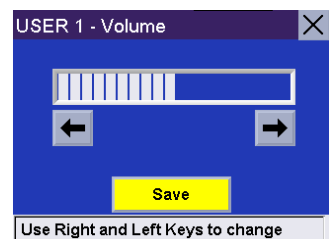

User Options

Auto Power Off

The Magellan RoadMate can be set to automatically shut itself off after 20 minutes of inactivity. Select **Auto power off**.

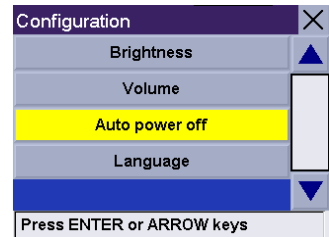

Select **Auto Power Off**. The box is checked indicating that the feature is active. Select **Save**.

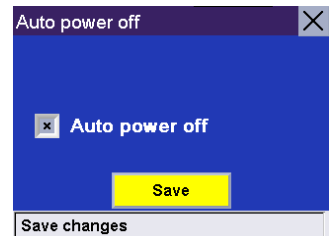

If after 20 minutes it has not received any input or changed location, an audible alert will sound and a screen will appear notifying you that the unit will shut down in 60 seconds. Pressing any key will disable this warning.

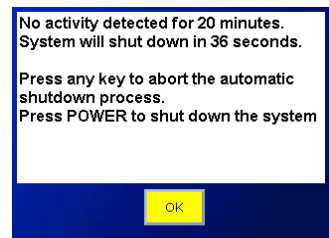

Language

The first time you use your Magellan RoadMate you will be asked to select a language. This language will be used for menu text and voice prompts. If you wish to change the language, press the **Option** button and select **Configuration**,

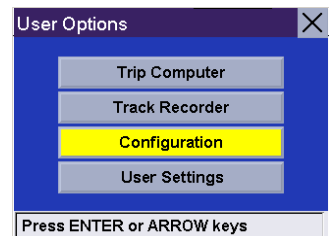

Select **Language**.

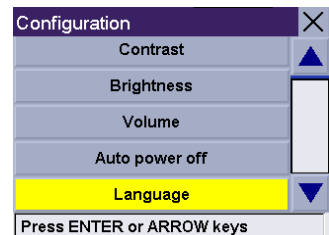

Select your preferred language. A dialog box will appear asking you to confirm your selection. Select **Yes** and the new language will be applied to menu selections and voice prompts.



User Options

User Settings

The Magellan RoadMate can be further configured to each user's preferences. From any screen, press the **Option** button. Select **User Settings**.

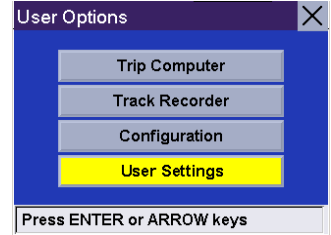

POI Selection

You can customize the Map screen to display all, none, or individual POIs. Select **POI Selection**.

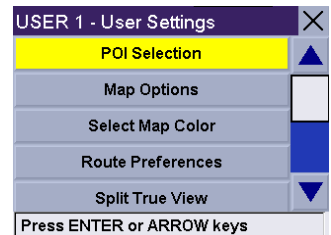

Select **Mark All** to show all available POI icons on the Map screen. Because of the size of the POI database, selecting to view all POIs on the screen can clutter the screen and make selecting individual POIs difficult.

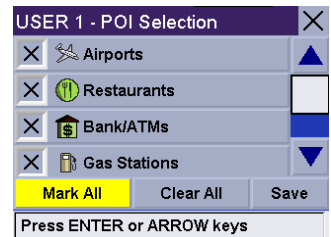

Select **Clear All** to remove all POI icons from the Map screen.

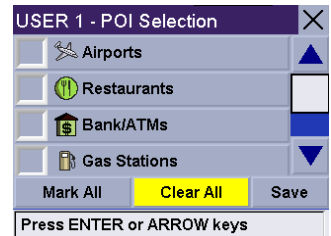

Or, you can individually select which icons to remove or show on the map screen. When you have finished selecting which icons you want to display, select **Save**.

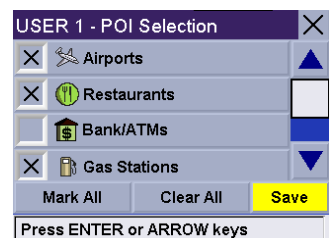

User Options

Map Options

You can customize how the data is displayed on the Map screen. Select **Map Options**.

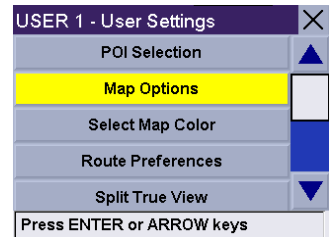

Select the options you wish to change. When you are finished, select **Save**.

Map Orientation. Heading Up sets the map display so that the direction of travel is always at the top of the screen. North Up sets the map so that the top of the screen always displays North.

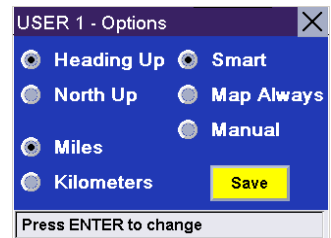

Units of Measure. Select miles or kilometers as the unit of measure for distance.

Map Guidance Option. Map Smart automatically changes the display from the Map screen to the TrueView screen before the maneuver. Map Always shows only the Map screen and the highlighted route. Map Manual allows the TrueView screen to be displayed only when the View button is pressed.

Select Map Color

You can change the color scheme of the map. Select **Select Map Color**.

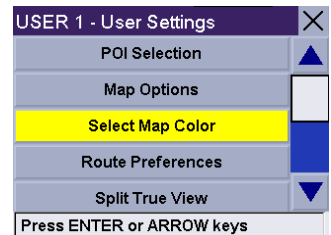

Select the desired color scheme. When you are finished, select **Save**.

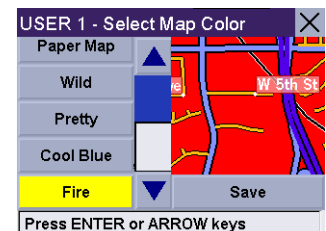
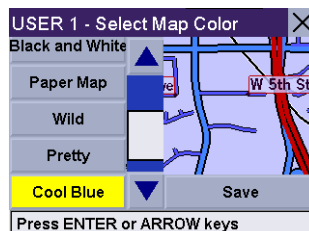
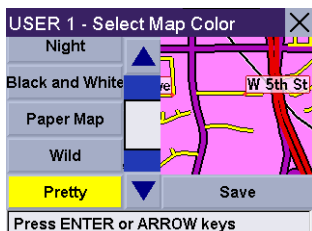
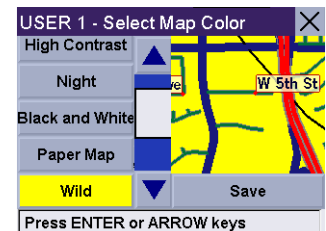
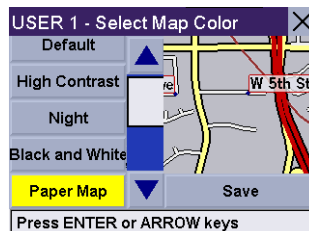
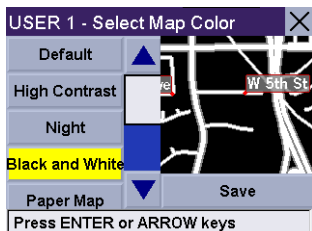
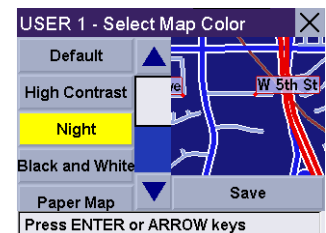
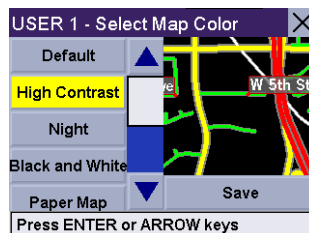
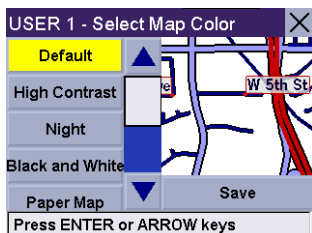

User Options

Route Preferences

Route preferences is where you activate or deactivate Automatic Re-Route. Automatic Re-Route enables the Magellan RoadMate to automatically re-calculate the route to the destination when it has detected that the vehicle is not on the previously calculated route. Select **Route Preferences**.

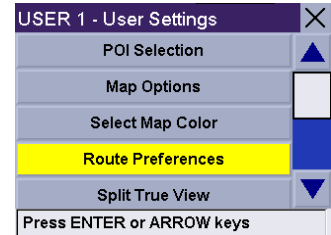

Select **Automatic Re-Route**. The box is checked indicating that the feature is active. Select **Save**.

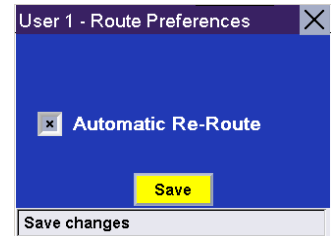

Split TrueView

With Split TrueView active, the normal TrueView screen is shown simultaneously with the map screen. Select **Split TrueView**.

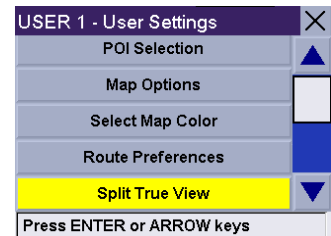

Select **Split TrueView**. The box is checked indicating that the feature is active. Select **Save**.

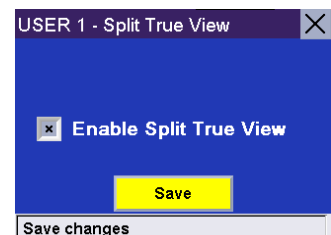

The TrueView screen is now split with one half showing TrueView, and the other half showing the map.

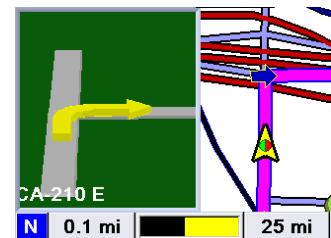

User Options

Menu Colors

Select **Menu Colors**.

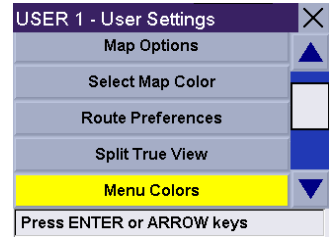

Select the preferred color scheme and select **Save**.

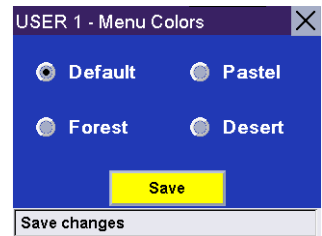

Default



Pastel

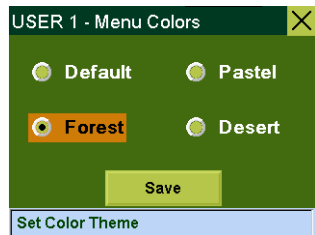

Forest



Desert

Tone Options

You can have the Magellan RoadMate alert you by one of three tones. Select **Tone Options**.

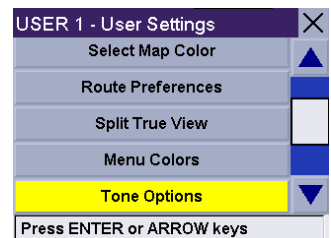

User Options

Select the desired sound you want the Magellan RoadMate to alert you with. When you are finished, select **Save**.



Diagnostics

The Magellan RoadMate has a number of diagnostic features that enable you to check the condition of the unit. Select **Diagnostics**.

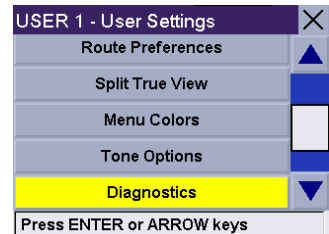

Video Test

Displays random colors to ensure that your display is working properly.

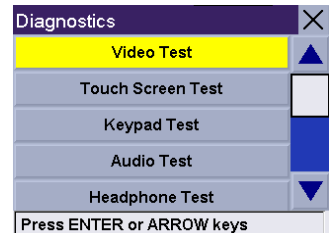

Touch Screen Test

Checks that the touch screen is calibrated and accurate.

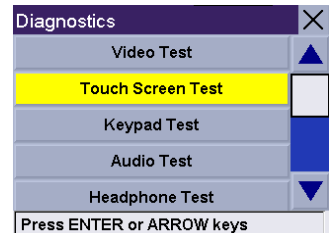

Keypad Test

Verifies proper operation of the keypad.

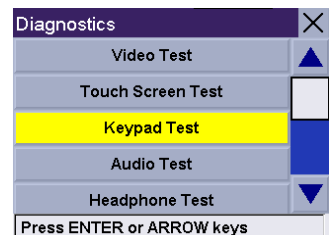

Audio Test

Checks that the speaker is working correctly.

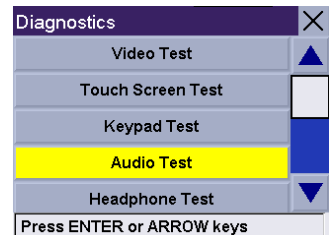

User Options

Headphone Test

Checks that sound is transmitted to the headphone jack correctly.

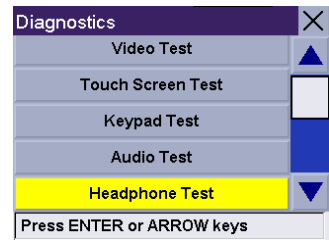

GPS Status

Monitors the satellite signal.

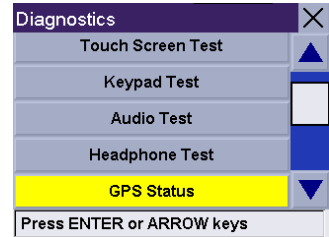

Initialize GPS

Resets the unit and reacquires the satellite signal. Note: Previously saved satellite data will be reset and reacquiring the satellite signal may take 15 minutes or more.

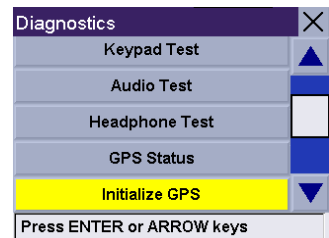

Set GPS Position

Enables you to manually set the location of the current position icon. If you have traveled a long distance with the unit off, it may take some time for the unit to reacquire a satellite signal. By manually setting the position of the unit you are telling the unit where you are and will speed up the satellite signal acquisition. There are two options for setting the GPS position:

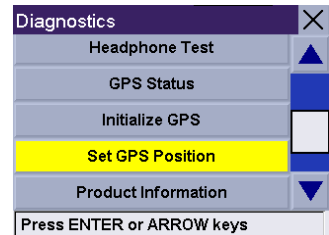

Search by Street enables you enter a specific address by which to set the GPS position. Select **Search by Street**.

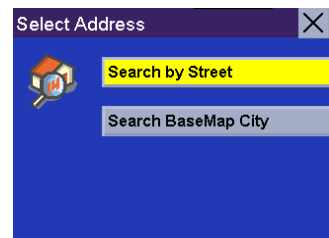

Select the detailed region the street is located in.

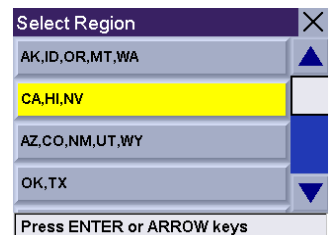

User Options

Enter the base name for the street. For example, if you are searching for “Overland Court” you would enter “OVERLAND”. As you type, the AutoFill will show the next possible match from the database. Select **OK**. For additional help with entering street names, see “Help with Street Names” on page 13.



Next, if the street you are looking for is within two to five cities, select the desired city from the list. If the desired street is within more than six cities, you will need to narrow down your search further by entering the city name. Again, as you type, AutoFill will display the next possible match. Select **OK**.

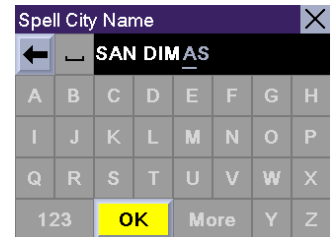

Enter the street address. The acceptable range of numbers is displayed at the top of the screen. If you do not know the exact address, just select Done and the Magellan RoadMate will route you to the lowest number in the range. Select **Done** to continue. You will be returned to the Diagnostics Screen.

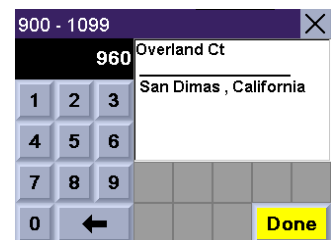

Go to the Map Screen. Your current position is now set to the address you entered.

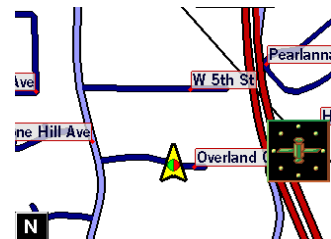

Search BaseMap City enables you enter a city center by which to set the GPS position if you don't know the exact address for your location. Select **Search BaseMap City**.

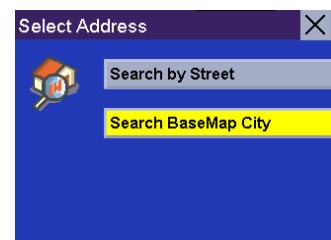

Enter the first few characters for the city. After you have selected the characters, select **OK**.

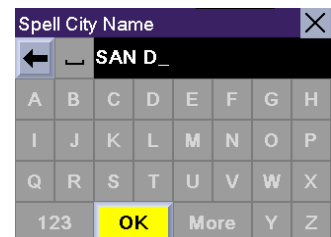

User Options

Use the navigation key to scroll the list up or down and select the desired city. You are returned to the Diagnostics Screen.

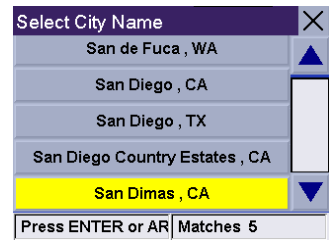

Product Information

Gives you detail about the hardware and software that is currently being used by the Magellan RoadMate. This feature is useful when receiving software updates.

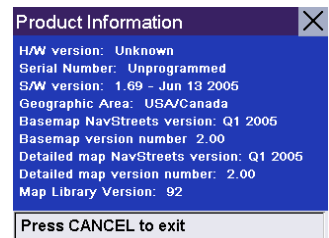
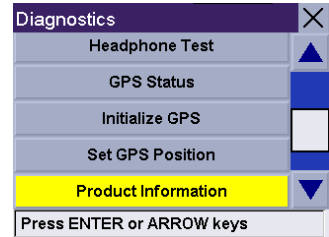

Simulator Mode

In Simulator Mode, you can demonstrate the capabilities of the Magellan RoadMate without actually driving. In order for the simulation to work, you must set a route first. Select **Simulator Mode**.

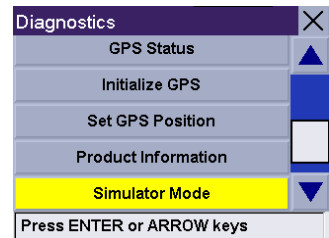

The **Propose simulator when calculating route** option will ask you if you want to activate the simulator after you select a location to route to.

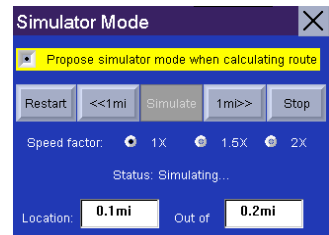

After you select your destination and select Route, a dialog box will appear asking you if you would like to simulate driving the route. Select **Yes**. The simulation will begin.

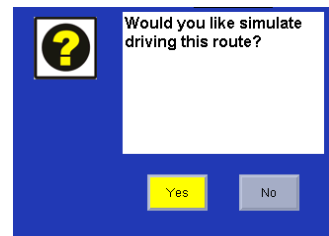

User Options

You can control the playback of the simulation by selecting **Restart** to start the simulation again, **Step Back** to go back along the route a distance of one mile, **Step Forward** to advance along the route a distance of one mile, or **Stop** to stop the simulation.

You can also control the speed coefficient at which the simulator runs. Where 1X is typical speed for the current road, 1.5X is one and one half times typical speed, and 2X is twice the typical speed.

Press **Cancel** to return to the map screen to view your route in progress.

System Messages

Gives you information on errors that you can relay to Technical Support.

User - Edit Name

You can change the default user name. Select **User - Edit Name**.

Use the backspace key to erase the default name and enter the name you wish to use for that user. When you have finished, select **OK**.

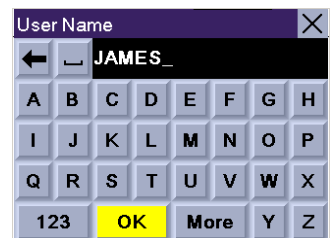
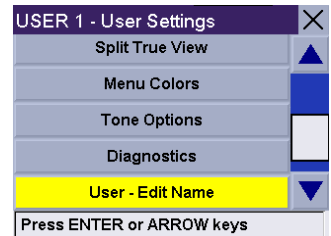
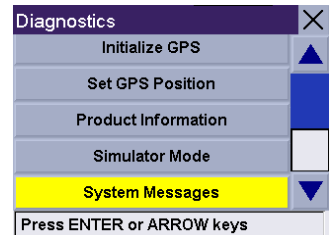
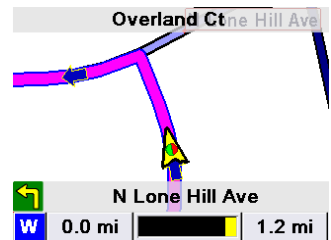
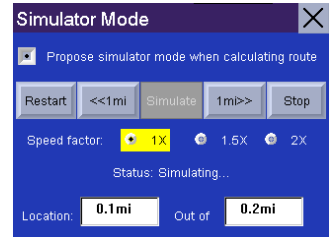
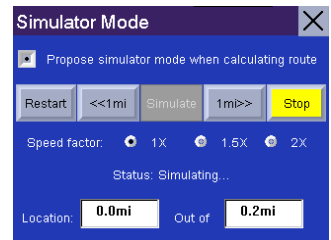

User Options

The user name is enabled.

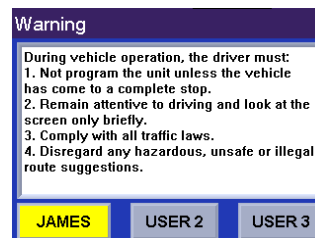

Password Settings

You can set a password for your user profile to protect your settings and to prevent unauthorized usage. Select **Password Settings**.

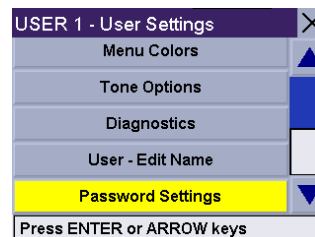

Select **Set Password**.

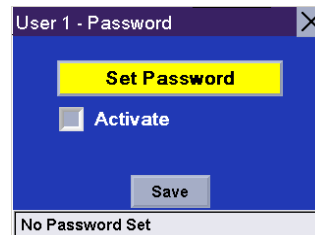

Enter the password you wish to use for your profile and select **OK**.

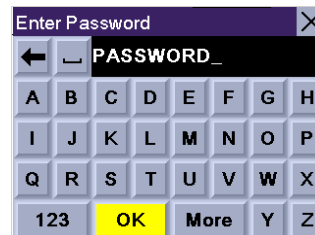

Select **Activate**. The box is checked indicating that the feature is active. Select **Save**.

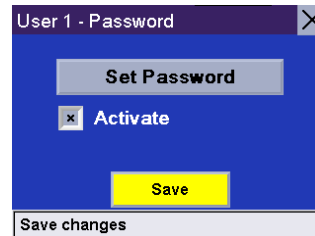

Confirm password protection activation by selecting **Yes**.

Password protection is now active. When you select your User profile at startup, you will be asked for your password in order to continue.

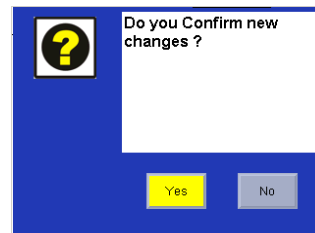

Appendix A

GPS Status Screen

GPS STATUS Screen Structure-first page

CH	PRN	AZ	EL	SNR	FRQ	U/N		
01	d1	d2	d3	d4	d5	c1	c2	d6
02	d1	d2	d3	d4	d5	c1	c2	d7
03	d1	d2	d3	d4	d5	c1	c2	
04	d1	d2	d3	d4	d5	c1	c2	
05	d1	d2	d3	d4	d5	c1	c2	
06	d1	d2	d3	d4	d5	c1	c2	
07	d1	d2	d3	d4	d5	c1	c2	
08	d1	d2	d3	d4	d5	c1	c2	
09	d1	d2	d3	d4	d5	c1	c2	
10	d1	d2	d3	d4	d5	c1	c2	
11	d1	d2	d3	d4	d5	c1	c2	
12	d1	d2	d3	d4	d5	c1	c2	
13	d1	d2	d3	d4	d5	c1	c2	
14	d1	d2	d3	d4	d5	c1	c2	

It is ordered by the channel number from 1 to 12.

Where:

- d1: Satellite PRN number, with “e” or “E” to the right means got ephemeris data, “v” or “V” to the right means got verified ephemeris data (double check). “E” or “V” also means got satellite time for this channel.
- d2: Azimuth, in degrees
- d3: Elevation angle, in degrees
- d4: SNR (signal to noise ratio), it is ratio-Hz, not dB unit
- d5: Searching Frequency Offset (Hz)
- c1: U – Used for position fix, U – Not used for position fix
- c2: Mode of the channel: I- Idle, S-searching, B – Bit sync, R- Reacquisition, T- Tracking, D-tracking and collecting data
- d6: Last Bad fix code. 0 means getting fixes. A non-zero value is either waiting for a fix or has a bad fix
- d7: Clock Offset (Hz).

Bad fix code

- 0 PVT_OK :good fix
- 2 ILLEGAL_ALT: illegal altitude < -10km or > 17.5km
- 4 POSITION_JUMP: too big position jump between two epoch (300 miles)
- 5 ILLEGAL_VELOCITY_OR_ALT: max velocity 951mile
- 7 TOO_BIG_ACCELERATION max 15m around 1.5g
- 8 TOO_SMALL_ALTITUDE -10000 m
- 9 TOO_BIG_ALTITUDE 17,500 m
- 10 TOO_BIG_PDOP max PDOP 50
- 11 SATS_BELOW_MASK_ANGLE satellite elevation angle is below mask angle
- 16 ILL_DEFINED_3D_MATRIX 3X3 matrix can not be inverted in 3D fix

Appendix A

17 ILL_DEFINED_2D_MATRIX 2X2 matrix can not be inverted in 2D fix
20 NO_SAT_TIME no satellite time
23 NOT_ENOUGH_SATS no enough satellite for 2D or 3D fix
24 CANNOT_SELECT_FIX_TYPE
30 VELOCITY_2D_ONLY 2 satellite fix only for velocity, no position fix
31 BAD_VELOCITY_PDOP 50 too big pdop for velocity
32 TOO_MANY_SATS_FOR_2D_VEL there are 4 or more satellites, but 2D fix provided
51 WRONG_NUMSAT number of satellite for fix > 12 or less 2
56 LOOP_3D_NOT_CONVERGING 3D initial fix is not convergent
57 MILLISECOND_ERROR millisecond jump happened
58 LOOP_2D_NOT_CONVERGING 2D initial fix is not convergent
59 BAD_RANGE_CHITEST; range post-fix residuals chi-test failed
60 BAD_DOPPLER_CHITEST doppler post-fix residuals chi-test failed
61 OSC_DRIFT_ERR too much clock drift 60HZ for XO, 7.5HZ for TCXO
62 BAD_DOPPLER_ERR too big Doppler errors 4m/s
63 BIG_RANGE_RESID 110m/40m depend on virtual ttag/ DGPS factors
64 BIG_DOPPLER_RESID 0.7m/s
65 HUGE_RANGE_RESID 10km normal for postfit residuals for range
66 HUGE_DOPPLER_RESID 100m/s normal for postfit residuals for doppler
Usually, Bad code is 20 and 23. If fix is good, it would be 0.

GPS STATUS Screen Structure - second page

Heading XXX (degree) Speeding XX.X (meter per second)
Current Lat: DDD.DDDDD W/E (current latitude, degree)
Current Long: DDD.DDDDD N/S (current longitude, degree)
Current altitude XXXX (altitude in mean sea level meter) TTFF XXXXs (Time-To-First-Fix in second)
#Satellite (U/T) XX/XX (the number of satellite used and tracked)
PDOP XX.X (Position Dilution Of Precision)
VDOP XX.X (Vertical Dilution of Precision)
TDOP XX.X (Time Dilution of Precision)
HDOP XX.X (Horizontal Dilution of Precision)
FOMS P/V/H (Figures Of Merits for position, velocity and heading in map matching)
UTC TIME MM/DD/YY HH:MM:SS(UTC time without local zone)

Appendix A

Typical GPS STATUS Screen Display

First Page

CH	PRN	AZ	EL	SNR	FRQ	U/N		
01	27V	311	54	334	1712	U	D	0
02	03E	078	29	135	-702	U	D	941
03	13e	079	81	204	-704	U	D	
04	20e	175	06	90	-1952	N	S	
05	31v	119	34	179	1525	U	D	
06	01V	120	53	316	-1954	U	D	
07	28V	220	13	152	3677	U	D	
08	08V	282	29	182	2848	U	D	
09	02V	046	27	173	2120	N	D	
10	84	255	12	0	934	N	S	
11	10	325	06	47	2257	N	S	
12	72	105	13	34	934	N	S	
13	134	255	12	50	171	N	S	
14	122	105	13	63	169	N	S	

Second Page

Heading 0 Speeding 0.0 m/s

Current Lat: 34.10939 N

Current Long: 117.82599 W

Current altitude 255 TTFF 116s

#Satellite (U/T) 11/12

PDOP 2.3

VDOP 1.7

TDOP 0.0

HDOP 1.3

FOMS P/V/H 2

UTC TIME 08/16/2004 22:56:53

















Appendix B

POI Categories

The Magellan RoadMate POI database has 41 different categories. The icons will appear on the Map screen (if enabled):

	Airport	International and Municipal airports
	Restaurant	Fast food, diners, and food marts
	Bank/ATM	Most financial services
	Gas Station	Most fuel services
	Hotel or Motel	Most overnight stay locations
	Car Rental	Car rental companies
	City Center	The geographical center of a selected city
	Vehicle Services	Repair shops, tire stores, and oil changes
	Amusement Park	Family fun spots
	Border Crossing	Border patrol stations along the US/Canada border
	Businesses	Business office locations
	Bus Station	Bus station locations
	Commuter Rail Station	Light Rail stations
	Court House	City, County, and State courts
	Entertainment	Movie theaters, live performance venues
	Exhibition Center	Major Convention Centers
	Ferry Terminal	River and lake crossings
	Golf Course	Private and public courses
	Grocery Store	Major chains and local markets
	Higher Education	Schools, Colleges, and other learning institutions
	Historical Monument	Places of public interest
	Hospital/Polyclinic	Most medical services
	Library	Local libraries

Appendix B

	Marina	Docks and harbors
	Museum	Local and county museums
	Parking Garage	Covered parking structures
	Parking Lot	Open parking areas
	Parks	County, regional, and local parks
	Park and Ride	Commuter carpool and buspool locations
	Performing Arts	Theaters and stages
	Police Station	Local, county and state law enforcement
	Rest Area	Rest stops along major highways
	School	Elementary and High School locations
	Shopping	Malls and other retail stores
	Ski Resorts	Most major ski resorts
	Sports	Stadiums, parks, lakes
	Tourist Attraction	Places most visited by tourists
	Train Station	Long distance rail stations
	Winery	Vinyards and tasting locations

When selecting restaurants, you can further narrow the search by cuisine type such as French, Italian, Greek, Mexican, etc.

Appendix C

Specifications

Dimensions:	3.1" x 6.2" x 1.2" 7.9cm x 15.7cm x 3.0cm
Weight:	9 oz. 255g
Display:	3.5" TFT color touch screen display, 2.2" x 2.9"
Screen Resolution:	320x240 QVGA, 32,000 colors
Audio:	Integrated Speaker
GPS Antenna:	Integrated, detachable for optional external antenna connection