



**samlex**power®

**DC-AC Power  
Inverter**  
Pure Sine Wave

PST-1500-12  
PST-1500-24  
PST-2000-12  
PST-2000-24

Owner's  
Manual

Please read this  
manual BEFORE  
installing your  
inverter

# OWNER'S MANUAL | Index

<b>SECTION 1</b>	Safety Instructions .....	3
<b>SECTION 2</b>	General Information .....	6
<b>SECTION 3</b>	Limiting Electromagnetic Interference (EMI) .....	11
<b>SECTION 4</b>	Powering Direct / Embedded Switch Mode Power Supplies (SMPS) .....	12
<b>SECTION 5</b>	Principle of Operation .....	14
<b>SECTION 6</b>	Layout.....	15
<b>SECTION 7</b>	General Information on Batteries for Powering Inverters .....	16
<b>SECTION 8</b>	Installation .....	27
<b>SECTION 9</b>	Operation .....	36
<b>SECTION 10</b>	Protections .....	38
<b>SECTION 11</b>	Trouble Shooting Guide .....	40
<b>SECTION 12</b>	Specifications .....	42
<b>SECTION 13</b>	Warranty .....	46

## DETAILED PRODUCT INFORMATION

**For a complete user manual including specifications, application notes, installation instructions, trouble shooting and more, please visit the web page for this product on [www.samlexamerica.com](http://www.samlexamerica.com). Product page can be found using the "Search by Model" field.**

# SECTION 1 | Safety Instructions

The following safety symbols will be used in this manual to highlight safety and information:



## **WARNING!**

Indicates possibility of physical harm to the user in case of non-compliance.



## **CAUTION!**

Indicates possibility of damage to the equipment in case of non-compliance.



## **INFO**

Indicates useful supplemental information.

Please read these instructions before installing or operating the unit to prevent personal injury or damage to the unit.

## **SAFETY INSTRUCTIONS - GENERAL**

### **Installation and wiring compliance**

- Installation and wiring must comply with the Local and National Electrical Codes and must be done by a certified electrician.

### **Preventing electrical shock**

- Always connect the grounding connection on the unit to the appropriate grounding system.
- Disassembly / repair should be carried out by qualified personnel only.
- Disconnect all AC and DC side connections before working on any circuits associated with the unit. Turning the ON/OFF switch on the unit to OFF position may not entirely remove dangerous voltages.
- Be careful when touching bare terminals of capacitors. The capacitors may retain high lethal voltages even after the power has been removed. Discharge the capacitors before working on the circuits.

### **Installation environment**

- The inverter should be installed indoor only in a well ventilated, cool, dry environment
- Do not expose to moisture, rain, snow or liquids of any type.
- To reduce the risk of overheating and fire, do not obstruct the suction and discharge openings of the cooling fans.
- To ensure proper ventilation, do not install in a low clearance compartment.

## SECTION 1 | Safety Instructions

### Preventing fire and explosion hazards

- Working with the unit may produce arcs or sparks. Thus, the unit should not be used in areas where there are flammable materials or gases requiring ignition protected equipment. These areas may include spaces containing gasoline-powered machinery, fuel tanks, and battery compartments.

### Precautions when working with batteries

- Batteries contain very corrosive diluted sulphuric acid as electrolyte. Precautions should be taken to prevent contact with skin, eyes or clothing.
- Batteries generate Hydrogen and Oxygen during charging resulting in evolution of explosive gas mixture. Care should be taken to ventilate the battery area and follow the battery manufacturer's recommendations.
- Never smoke or allow a spark or flame near the batteries.
- Use caution to reduce the risk of dropping a metal tool on the battery. It could spark or short circuit the battery or other electrical parts and could cause an explosion.
- Remove metal items like rings, bracelets and watches when working with batteries. The batteries can produce a short circuit current high enough to weld a ring or the like to metal and thus cause a severe burn.
- If you need to remove a battery, always remove the ground terminal from the battery first. Make sure that all the accessories are off so that you do not cause a spark.

## SAFETY INSTRUCTIONS - INVERTER RELATED

### Preventing Paralleling of the AC Output

The AC output of the unit should never be connected directly to an Electrical Breaker Panel / Load Centre which is also fed from the utility power / generator. Such a direct connection may result in parallel operation of the different power sources and AC power from the utility / generator will be fed back into the unit which will instantly damage the output section of the unit and may also pose a fire and safety hazard. If an Electrical Breaker Panel / Load Center is fed from this unit and this panel is also required to be fed from additional alternate AC sources, the AC power from all the AC sources (like the utility / generator / this inverter) should first be fed to an Automatic / Manual Selector Switch and the output of the Selector Switch should be connected to the Electrical Breaker Panel / Load Center.



### CAUTION!

To prevent possibility of paralleling and severe damage to the unit, never use a simple jumper cable with a male plug on both ends to connect the AC output of the unit to a handy wall receptacle in the home / RV.

### Preventing DC Input Over Voltage

It is to be ensured that the DC input voltage of this unit does not exceed 16.5 VDC for

# SECTION 1 | Safety Instructions

the 12V battery version and 33.0 VDC for the 24V battery version to prevent permanent damage to the unit. Please observe the following precautions:

- Ensure that the maximum charging voltage of the external battery charger / alternator / solar charge controller does not exceed 16.5 VDC for the 12V battery version and 33.0 VDC for the 24V battery version
- Do not use unregulated solar panels to charge the battery connected to this unit. Under cold ambient temperatures, the output of the solar panel may reach > 22 VDC for 12V Battery System and > 44 VDC for the 24V Battery system. Always use a charge controller between the solar panel and the battery.
- Do not connect this unit to a battery system with a voltage higher than the rated battery input voltage of the unit (e.g. do not connect the 12V version of the unit to 24V battery system or the 24V version to the 48V Battery System)

## Preventing Reverse Polarity on the Input Side

When making battery connections on the input side, make sure that the polarity of battery connections is correct (Connect the Positive of the battery to the Positive terminal of the unit and the Negative of the battery to the Negative terminal of the unit). If the input is connected in reverse polarity, DC fuse(s) inside the inverter will blow and may also cause permanent damage to the inverter.



### CAUTION!

Damage caused by reverse polarity is not covered by warranty.

## Using Hard Wiring AC Output Connections in Vehicles



### WARNING!

#### RISK OF ELECTRIC SHOCK

When this unit is installed in vehicles and hard-wiring connection is used to feed the AC output of the inverter to the AC Distribution Panel / Load Center in the vehicle, it is to be ensured that Ground Fault Circuit Interrupter(s) [GFCI] are installed in the vehicle wiring system to protect all branch circuits.

The following GFCIs have been tested to operate satisfactorily and are acceptable. Other types may fail to operate properly when connected to this inverter:

Manufacturer of GFCI	Manufacturer's Model No.	Description
Pass & Seymour	2095 Series	NEMA5-20 Duplex, 20A
Leviton	7899 Series	NEMA5-20 Duplex, 20A
Zhejiang Trimone	TGM20 Series	NEMA5-20 Duplex, 20A

## SECTION 2 | General Information

The following definitions are used in this manual for explaining various electrical concepts, specifications and operations:

**Peak Value:** It is the maximum value of electrical parameter like voltage / current.

**RMS (Root Mean Square) Value:** It is a statistical average value of a quantity that varies in value with respect to time. For example, a pure sine wave that alternates between peak values of Positive 169.68V and Negative 169.68V has an RMS value of 120 VAC. Also, for a pure sine wave, the RMS value = Peak value  $\div$  1.414.

**Voltage (V), Volts:** It is denoted by "V" and the unit is "Volts". It is the electrical force that drives electrical current (I) when connected to a load. It can be DC (Direct Current – flow in one direction only) or AC (Alternating Current – direction of flow changes periodically). The AC value shown in the specifications is the RMS (Root Mean Square) value.

**Current (I), Amps, A:** It is denoted by "I" and the unit is Amperes – shown as "A". It is the flow of electrons through a conductor when a voltage (V) is applied across it.

**Frequency (F), Hz:** It is a measure of the number of occurrences of a repeating event per unit time. For example, cycles per second (or Hertz) in a sinusoidal voltage.

**Efficiency, ( $\eta$ ):** This is the ratio of Power Output  $\div$  Power Input.

**Phase Angle, ( $\phi$ ):** It is denoted by " $\phi$ " and specifies the angle in degrees by which the current vector leads or lags the voltage vector in a sinusoidal voltage. In a purely inductive load, the current vector lags the voltage vector by Phase Angle ( $\phi$ ) = 90°. In a purely capacitive load, the current vector leads the voltage vector by Phase Angle, ( $\phi$ ) = 90°. In a purely resistive load, the current vector is in phase with the voltage vector and hence, the Phase Angle, ( $\phi$ ) = 0°. In a load consisting of a combination of resistances, inductances and capacitances, the Phase Angle ( $\phi$ ) of the net current vector will be  $> 0^\circ < 90^\circ$  and may lag or lead the voltage vector.

**Resistance (R),  $\Omega$ :** It is the property of a conductor that opposes the flow of current when a voltage is applied across it. In a resistance, the current is in phase with the voltage. It is denoted by "R" and its unit is "Ohm" - also denoted as " $\Omega$ ".

**Inductive Reactance ( $X_L$ ), Capacitive Reactance ( $X_C$ ) and Reactance (X):** Reactance is the opposition of a circuit element to a change of electric current or voltage due to that element's inductance or capacitance. Inductive Reactance ( $X_L$ ) is the property of a coil of wire in resisting any change of electric current through the coil. It is proportional to frequency and inductance and causes the current vector to lag the voltage vector by Phase Angle ( $\phi$ ) = 90°. Capacitive reactance ( $X_C$ ) is the property of capacitive elements to oppose changes in voltage.  $X_C$  is inversely proportional to the frequency and capacitance and causes the current vector to lead the voltage vector by Phase Angle ( $\phi$ ) = 90°. The unit of both  $X_L$  and  $X_C$  is "Ohm" - also denoted as " $\Omega$ ". The effects of inductive reactance  $X_L$  to cause the current to lag the voltage by 90° and that of the capacitive reactance  $X_C$  to cause the current to lead the voltage by 90° are exactly opposite and the net

## SECTION 2 | General Information

effect is a tendency to cancel each other. Hence, in a circuit containing both inductances and capacitances, the net **Reactance (X)** will be equal to the difference between the values of the inductive and capacitive reactances. The net **Reactance (X)** will be inductive if  $X_L > X_C$  and capacitive if  $X_C > X_L$ .

**Impedance, Z:** It is the vectorial sum of Resistance and Reactance vectors in a circuit.  
**Active Power (P), Watts:** It is denoted as “P” and the unit is “Watt”. It is the power that is consumed in the resistive elements of the load. A load will require additional Reactive Power for powering the inductive and capacitive elements. The effective power required would be the Apparent Power that is a vectorial sum of the Active and Reactive Powers.

**Reactive Power (Q), VAR:** Is denoted as “Q” and the unit is VAR. Over a cycle, this power is alternatively stored and returned by the inductive and capacitive elements of the load. It is not consumed by the inductive and capacitive elements in the load but a certain value travels from the AC source to these elements in the (+) half cycle of the sinusoidal voltage (Positive value) and the same value is returned back to the AC source in the (-) half cycle of the sinusoidal voltage (Negative value). Hence, when averaged over a span of one cycle, the net value of this power is 0. However, on an instantaneous basis, this power has to be provided by the AC source. *Hence, the inverter, AC wiring and over current protection devices have to be sized based on the combined effect of the Active and Reactive Powers that is called the Apparent Power.*

**Apparent (S) Power, VA:** This power, denoted by “S”, is the vectorial sum of the Active Power in Watts and the Reactive Power in “VAR”. In magnitude, it is equal to the RMS value of voltage “V” X the RMS value of current “A”. The Unit is VA. *Please note that Apparent Power VA is more than the Active Power in Watts. Hence, the inverter, AC wiring and over current protection devices have to be sized based on the Apparent Power.*

**Power Factor, (PF):** It is denoted by “PF” and is equal to the ratio of the Active Power (P) in Watts to the Apparent Power (S) in VA. The maximum value is 1 for resistive types of loads where the Active Power (P) in Watts = the Apparent Power (S) in VA. It is 0 for purely inductive or purely capacitive loads. Practically, the loads will be a combination of resistive, inductive and capacitive elements and hence, its value will be  $> 0 < 1$ . Normally it ranges from 0.5 to 0.8.

**Load:** Electrical appliance or device to which an electrical voltage is fed.

**Linear Load:** A load that draws sinusoidal current when a sinusoidal voltage is fed to it. Examples are, incandescent lamp, heater, electric motor, etc.

**Non-Linear Load:** A load that does not draw a sinusoidal current when a sinusoidal voltage is fed to it. For example non-power factor corrected Switched Mode Power Supplies (SMPS) used in computers, audio video equipment, battery chargers, etc.

**Resistive Load:** A device or appliance that consists of pure resistance (like filament lamps, cook tops, toaster, coffee maker etc.) and draws only Active Power (Watts) from

## SECTION 2 | General Information

the inverter. The inverter can be sized based on the Active Power rating (Watts) without creating overload.

**Reactive Load:** A device or appliance that consists of a combination of resistive, inductive and capacitive elements (like motor driven tools, refrigeration compressors, microwaves, computers, audio/ video etc.). These devices require Apparent Power (VA) from the inverter to operate. The Apparent Power is a vectorial sum of Active Power (Watts) and Reactive Power (VAR). *The inverter has to be sized based on the higher Apparent Power (VA).*

### Output Voltage Waveforms

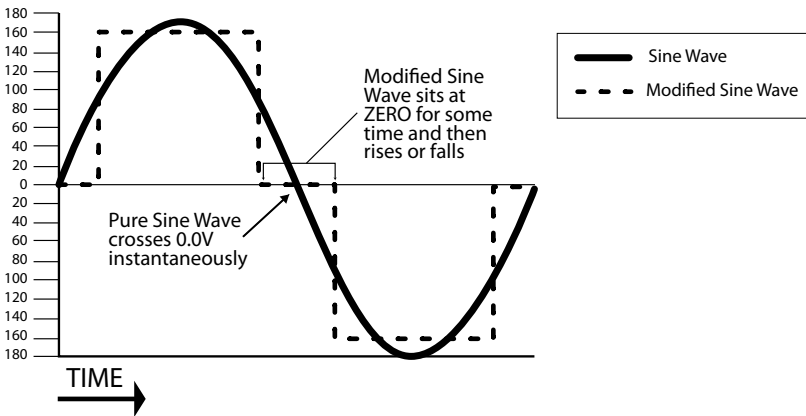

Fig. 2.1: Pure and Modified Sine Waveforms

The output waveform of the Samlex PST series inverters is a pure sine wave like the waveform of the grid power. Please see sine wave represented in the Fig. 2.1 that also shows modified waveform for comparison.

In a sine wave, the voltage rises and falls smoothly with a smoothly changing phase angle and also changes its polarity instantly when it crosses 0 Volts. In a modified sine wave, the voltage rises and falls abruptly, the phase angle also changes abruptly and it sits at 0Vs for some time before changing its polarity. Thus, any device that uses a control circuitry that senses the phase (for voltage / speed control) or instantaneous zero voltage crossing (for timing control) will not work properly from a voltage that has a modified sine waveform.

Also, as the modified sine wave is a form of square wave, it is comprised of multiple sine waves of odd harmonics (multiples) of the fundamental frequency of the modified sine wave. For example, a 60 Hz modified sine wave will consist of sine waves with odd harmonic frequencies of 3rd (180 Hz), 5th (300 Hz), 7th (420 Hz) and so on. The high



## SECTION 2 | General Information

frequency harmonic content in a modified sine wave produces enhanced radio interference, higher heating effect in inductive loads like microwaves and motor driven devices like hand tools, refrigeration / air-conditioning compressors, pumps etc. The higher frequency harmonics also produce overloading effect in low frequency capacitors due to lowering of their capacitive reactance by the higher harmonic frequencies. These capacitors are used in ballasts for fluorescent lighting for Power Factor improvement and in single-phase induction motors as start and run capacitors. Thus, modified and square wave inverters may shut down due to overload when powering these devices.

### Advantages of Pure Sine Wave Inverters

- The output waveform is a sine wave with very low harmonic distortion and cleaner power like utility supplied electricity.
- Inductive loads like microwaves, motors, transformers etc. run faster, quieter and cooler.
- More suitable for powering fluorescent lighting fixtures containing power factor improvement capacitors and single phase motors containing start and run capacitors
- Reduces audible and electrical noise in fans, fluorescent lights, audio amplifiers, TV, fax and answering machines.
- Does not contribute to the possibility of crashes in computers, weird print outs and glitches in monitors.

### Some examples of devices that may not work properly with modified sine wave and may also get damaged are given below:

- Laser printers, photocopiers, and magneto-optical hard drives.
- Built-in clocks in devices such as clock radios, alarm clocks, coffee makers, bread-makers, VCR, microwave ovens etc. may not keep time correctly.
- Output voltage control devices like dimmers, ceiling fan / motor speed control may not work properly (dimming / speed control may not function).
- Sewing machines with speed / microprocessor control.
- Transformer-less capacitive input powered devices like (i) Razors, flashlights, night-lights, smoke detectors etc. (ii) Re-chargers for battery packs used in hand power tools. *These may get damaged. Please check with the manufacturer of these types of devices for suitability.*
- Devices that use radio frequency signals carried by the AC distribution wiring.
- Some new furnaces with microprocessor control / Oil burner primary controls.
- High intensity discharge (HID) lamps like Metal Halide lamps. *These may get damaged. Please check with the manufacturer of these types of devices for suitability.*
- Some fluorescent lamps / light fixtures that have power factor correction capacitors. *The inverter may shut down indicating overload.*

## SECTION 2 | General Information

### Power Rating of the Inverters

The continuous output power rating of the inverter is specified in Active Power in Watts for resistive types of loads like heating elements, incandescent lamps etc. where Power Factor (PF) = 1. The Surge Power rating is for < 1 sec.

Non resistive / reactive loads with Power Factor < 1 like motors (PF = 0.4 to 0.8), non Power Factor corrected electronics (PF = 0.5 to 0.6) etc, will draw higher Apparent Power in Volt Amps (VA). This Apparent Power is the sum of Active Power in Watts plus Reactive Power in VAR and is = Active Power in Watts ÷ Power Factor. Thus, for such reactive loads, higher sized inverter is required based on the Apparent Power. Further, all reactive types of loads require higher inrush / starting surge power that may last for > 1 to 5 sec and subsequent lower running power. If the inverter is not sized adequately based on the type of AC load, it is likely to shut down or fail prematurely due to repeated overloading.



#### INFO

The manufacturers' specification for power rating of the appliances and devices indicates only the running power required. The surge power required by some specific types of devices as explained above has to be determined by actual testing or by checking with the manufacturer. This may not be possible in all cases and hence, can be guessed at best, based on some general rules of thumb.

Table 2.1 below lists some common loads that require high surge power on start up. A "Sizing Factor" has been recommended against each which is a multiplication factor to be applied to the rated running Watt rating of the load to arrive at the Continuous Power Rating of the inverter (Multiply the running Watts of the device/ appliance by the Sizing Factor to arrive at the size of the inverter).

<b>TABLE 2.1: INVERTER SIZING FACTOR</b> <b>Type of Device or Appliance</b>	<b>Inverter Sizing Factor*</b>
Air Conditioner / Refrigerator / Freezer (Compressor based)	5
Air Compressor	4
Sump Pump / Well Pump / Submersible Pump	3
Dishwasher / Clothes Washer	3
Microwave (where rated output power is the cooking power)	2
Furnace Fan	3
Industrial Motor	3
Portable Kerosene / Diesel Fuel Heater	3
Circular Saw / Bench Grinder	3
Incandescent / Halogen / Quartz Lamps	3

Table Continues Next Page ►

## SECTION 2 | General Information

TABLE 2.1: INVERTER SIZING FACTOR Type of Device or Appliance	Inverter Sizing Factor*
Laser Printer / Other Devices using Quartz Lamps for heating	4
Switch Mode Power Supplies (SMPS): no Power Factor correction	3
Photographic Strobe / Flash Lights	4 (Note 1)

\* *Multiply the Running Active Power Rating {Watts} of the appliance by this Factor to arrive at the Continuous Power Rating of the inverter for powering this appliance.*

### TABLE 2.1: NOTES

1. For photographic strobe / flash unit, the surge power of the inverter should be > 4 times the Watt Sec rating of photographic strobe / flash unit.

## SECTION 3 | Limiting Electro-Magnetic Interference (EMI)

These inverters contain internal switching devices that generate conducted and radiated electromagnetic interference (EMI). The EMI is unintentional and cannot be entirely eliminated. The magnitude of EMI is, however, limited by circuit design to acceptable levels as per limits laid down in North American FCC Standard FCC Part 15(B), Class B. These limits are designed to provide reasonable protection against harmful interference when the equipment is operated *in a residential environment*. These inverters can conduct and radiate radio frequency energy and, if not installed and used in accordance with the instruction manual, may cause harmful interference to radio communications. The effects of EMI will also depend upon a number of factors external to the inverter like proximity of the inverter to the EMI receptors, types and quality of connecting wires and cables etc. EMI due to factors external to the inverter may be reduced as follows:



### INFO

- Ensure that the inverter is firmly grounded to the ground system of the building or the vehicle
- Locate the inverter as far away from the EMI receptors like radio, audio and video devices as possible
- Keep the DC side wires between the battery and the inverter as short as possible.
- Do NOT keep the battery wires far apart. Keep them taped together to reduce their inductance and induced voltages. This reduces ripple in the battery wires and improves performance and efficiency.
- Shield the DC side wires with metal sheathing / copper foil / braiding:
  - Use coaxial shielded cable for all antenna inputs (instead of 300 ohm twin leads)
  - Use high quality shielded cables to attach audio and video devices to one another
- Limit operation of other high power loads when operating audio / video equipment

## SECTION 4 | Powering Direct / Embedded Switch Mode Power Supplies (SMPS)

Switch Mode Power Supplies (SMPS) are extensively used to convert the incoming AC power into various voltages like 3.3V, 5V, 12V, 24V etc. that are used to power various devices and circuits used in electronic equipment like battery chargers, computers, audio and video devices, radios etc. These power supplies use large capacitors in their input section for filtration. When the power supply is first turned on, there is a very large inrush current drawn by the power supply as the input capacitors are charged (The capacitors act almost like a short circuit at the instant the power is turned on). The inrush current at turn-on is several to tens of times larger than the rated RMS input current and lasts for a few milliseconds. An example of the input voltage versus input current waveforms is given in Fig. 4.1. It will be seen that the initial input current pulse just after turn-on is > 15 times larger than the steady state RMS current. The inrush dissipates in around 2 or 3 cycles i.e. in around 33 to 50 milliseconds for 60 Hz sine wave.

Further, due to the presence of high value of input filter capacitors, the current drawn by an SMPS (With no Power Factor correction) is not sinusoidal but non-linear as shown in Fig.4.2 above. The steady state input current of SMPS is a train of non-linear pulses instead of a sinusoidal wave. These pulses are two to four milliseconds duration each when on 50 Hz power, with a very high Crest Factor corresponding to peak values around 3 times the RMS value of the input current:

(Crest Factor = Peak value ÷ RMS value).

Many SMPS units incorporate “Inrush Current Limiting”. The most common method is the NTC (Negative Temperature Coefficient) resistor. The NTC resistor has a high resistance when cold and a low resistance when hot. The NTC resistor is placed in series with the input to the power supply. The cold resistance limits the input current as the input capacitors charge up. The input current heats up the NTC and the resistance drops during normal operation. However, if the power supply is quickly turned off and back on, the NTC resistor will be hot so its low resistance state will not prevent an inrush current event.

The inverter should, therefore, be sized adequately to withstand the high inrush current and the high Crest Factor of the current drawn by the SMPS. *Hence, it is recommended that for purposes of sizing the inverter, the continuous power of the inverter should be > 3 times the continuous rated power of the SMPS. For example, an SMPS rated at 100 Watts should be powered from an inverter that has continuous power of > 300 Watts.*

## SECTION 4 | Powering Direct / Embedded Switch Mode Power Supplies (SMPS)

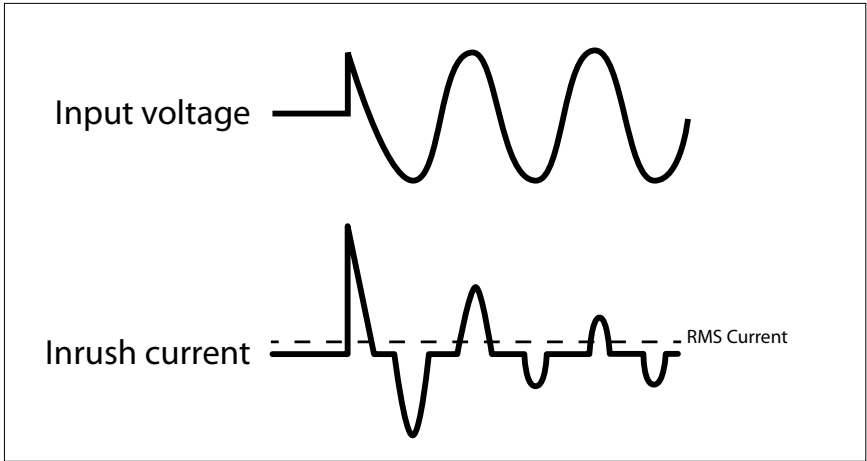

Fig 4.1: Inrush current in an SMPS

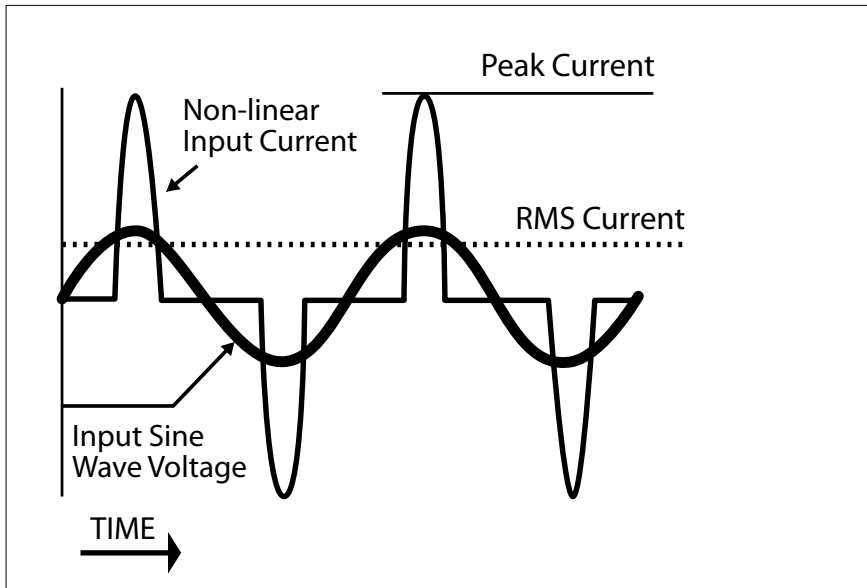

Fig. 4.2: High Crest Factor of current drawn by SMPS

## SECTION 5 | Principle of Operation

These inverters convert DC battery voltage to AC voltage with an RMS (Root Mean Square) value of 120 VAC, 60 Hz RMS.

The waveform of the AC voltage is a pure sine wave form that is same as the waveform of grid power (*Supplementary information on pure sine waveform and its advantages are discussed on pages 8 & 9*).

Fig. 5.1 below specifies the characteristics of 120 VAC, 60 Hz pure sine waveform. The instantaneous value and polarity of the voltage varies cyclically with respect to time. For example, in one cycle in a 120 VAC, 60 Hz system, it slowly rises in the positive direction from 0V to a peak positive value "V<sub>peak</sub>" = + 168.69V, slowly drops to 0V, changes the polarity to negative direction and slowly increases in the negative direction to a peak negative value "V<sub>peak</sub>" = - 168.69V and then slowly drops back to 0V. There are 60 such cycles in 1 sec. Cycles per second is called the "Frequency" and is also termed "Hertz (Hz)".

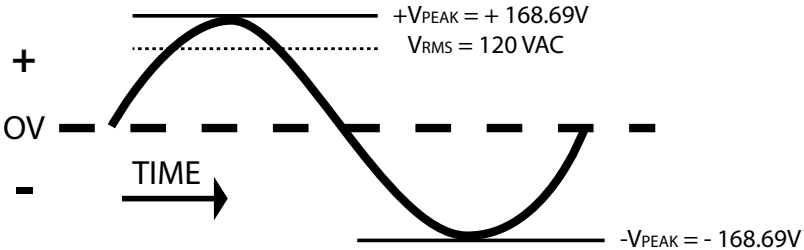
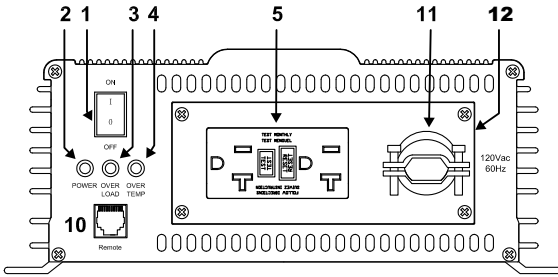

Fig. 5.1: 120 VAC, 60 Hz Pure Sine Waveform

The voltage conversion takes place in two stages. In the first stage, the DC voltage of the battery is converted to a high voltage DC using high frequency switching and Pulse Width Modulation (PWM) technique. In the second stage, the high voltage DC is converted to 120 VAC, 60 Hz sine wave AC again using PWM technique. This is done by using a special wave shaping technique where the high voltage DC is switched at a high frequency and the pulse width of this switching is modulated with respect to a reference sine wave.

# SECTION 6 | Layout



**PST-1500 & PST-2000: FRONT**

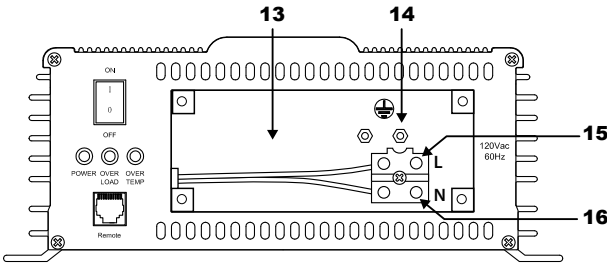

**PST-1500 & PST-2000: FRONT** - showing compartment containing AC output terminals for hardwiring.

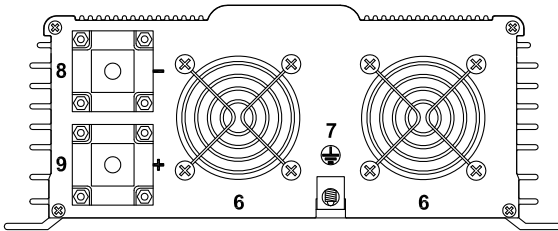

**PST-1500 & PST-2000: BACK**

## LEGEND

- |   |   |
|---|---|
| <ul style="list-style-type: none"> <li>1. Power ON/OFF Switch</li> <li>2. Green LED - Power ON</li> <li>3. Red LED - Overload</li> <li>4. Red LED - Over Temperature</li> <li>5. NEMA5-20R GFCI Duplex Outlets</li> <li>6. Cooling Fan Opening</li> <li>7. Grounding Lug</li> <li>8. Negative (-) DC Input Terminal</li> <li>9. Positive (+) DC Input Terminal</li> <li>10. Modular Jack for RC-15A Remote Control</li> </ul> | <ul style="list-style-type: none"> <li>11. Metal Strain Relief Clamp for AC Output Cable</li> <li>12. Cover Plate for Compartment Containing AC Output Terminals</li> <li>13. Compartment Containing AC Output Terminals for Hardwiring</li> <li>14. Terminal for AC Output Ground (Chassis Ground)</li> <li>15. AC Output: Line Terminal</li> <li>16. AC Output: Neutral Terminal</li> </ul> |
|---|---|

Fig. 6.1: Layout of PST-1500 and PST-2000

## SECTION 7 | General Information on Batteries for Powering Inverters

Lead-acid batteries can be categorized by the type of application:

1. Automotive service - Starting/Lighting/Ignition (SLI, a.k.a. cranking), and
2. Deep cycle service.

Deep Cycle Lead Acid Batteries of appropriate capacity are recommended for the powering of inverters.

### Deep Cycle Lead Acid Batteries

Deep cycle batteries are designed with thick-plate electrodes to serve as primary power sources, to have a constant discharge rate, to have the capability to be deeply discharged up to 80 % capacity and to repeatedly accept recharging. They are marketed for use in recreation vehicles (RV), boats and electric golf carts – so they may be referred to as RV batteries, marine batteries or golf cart batteries. Use Deep Cycle batteries for powering these inverters.

### Rated Capacity in Ampere-hour (Ah)

Battery capacity “C” is specified in Ampere-hours (Ah). An Ampere is the unit of measurement for electrical current and is defined as a Coulomb of charge passing through an electrical conductor in one second. The Capacity “C” in Ah relates to the ability of the battery to provide a constant specified value of discharge current (also called “C-Rate”) over a specified time in hours before the battery reaches a specified discharged terminal voltage (Also called “End Point Voltage”) at a specified temperature of the electrolyte. As a benchmark, the automotive battery industry rates batteries at a “Discharge Rate” C/20 Amperes corresponding to 20 Hour discharge period. The rated capacity “C” in Ah in this case will be the number of Amperes of current the battery can deliver for 20 Hours at 80°F (26.7°C) till the voltage drops to 1.75V / Cell. i.e. 10.5V for 12V battery, 21V for 24V battery and 42V for a 48V battery. For example, a 100 Ah battery will deliver 5A for 20 Hours.

### Rated Capacity in Reserve Capacity (RC)

Battery capacity may also be expressed as Reserve Capacity (RC) in minutes typically for automotive SLI (Starting, Lighting and Ignition) batteries. It is the time in minutes a vehicle can be driven after the charging system fails. This is roughly equivalent to the conditions after the alternator fails while the vehicle is being driven at night with the headlights on. The battery alone must supply current to the headlights and the computer/ignition system. The assumed battery load is a constant discharge current of 25 A. Reserve capacity is the time in minutes for which the battery can deliver 25 Amperes at 80°F (26.7°C) till the voltage drops to 1.75V / Cell i.e. 10.5V for 12V battery, 21V for 24V battery and 42V for 48V battery.

Approximate relationship between the two units is:

$$\text{Capacity "C" in Ah} = \text{Reserve Capacity in RC minutes} \times 0.6$$



## SECTION 7 | General Information on Batteries for Powering Inverters

### Typical Battery Sizes

The Table 7.1 below shows details of some popular battery sizes:

TABLE 7.1: POPULAR BATTERY SIZES		
BCI* Group	Battery Voltage, V	Battery Capacity, Ah
27 / 31	12	105
4D	12	160
8D	12	225
GC2**	6	220

\* Battery Council International; \*\* Golf Cart

### Specifying Charging / Discharging Currents: C-Rate

Electrical energy is stored in a cell / battery in the form of DC power. The value of the stored energy is related to the amount of the active materials pasted on the battery plates, the surface area of the plates and the amount of electrolyte covering the plates. As explained above, the amount of stored electrical energy is also called the Capacity of the battery and is designated by the symbol "C".

The time in Hours over which the battery is discharged to the "End Point Voltage" for purposes of specifying Ah capacity depends upon the type of application. Let us denote this discharge time in hours by "T". Let us denote the discharge current of the battery as the "C-Rate". If the battery delivers a very high discharge current, the battery will be discharged to the "End Point Voltage" in a shorter period of time. On the other hand, if the battery delivers a lower discharge current, the battery will be discharged to the "End Point Voltage" after a longer period of time. Mathematically:

#### EQUATION 1:

$$\text{Discharge current "C-Rate"} = \text{Capacity "C" in Ah} \div \text{Discharge Time "T"}$$

## SECTION 7 | General Information on Batteries for Powering Inverters

Table 7.2 below gives some examples of C-Rate specifications and applications:

TABLE 7.2: DISCHARGE CURRENT RATES - "C-RATES"				
Hours of discharge time "T" till the "End Point Voltage"	C-Rate Discharge Current in Amps			Example of C-Rate Discharge Currents for 100 Ah battery
	Fraction	Decimal	Subscript	
0.5 Hrs.	2C	2C	2C	200A
1 Hrs.	1C	1C	1C	100A
5 Hrs.	C/5	0.2C	C5	20A
8 Hrs. (UPS application)	C/8	0.125C	C8	12.5A
10 Hrs. (Telecom application)	C/10	0.1C	C10	10A
20 Hrs. (Automotive application)	C/20	0.05C	C20	5A
100 Hrs.	C/100	0.01C	C100	1A

**NOTE:** When a battery is discharged over a shorter time, its specified "C-Rate" discharge current will be higher. For example, the "C-Rate" discharge current at 5 Hour discharge period i.e. 0.2C / C5 / C/5 Amps will be 4 times higher than the "C-Rate" discharge current at 20 Hour discharge period i.e. 0.05C / C20 / C/20 Amps.

### Charging / Discharging Curves

Fig. 7.1 (page 19) shows the charging and discharging characteristics of a typical, 6 cell, 12V, Lead Acid battery at electrolyte temperature of 80°F / 26.7°C. The curves show the % State of Charge (X-axis) versus terminal voltage (Y-axis) during charging and discharging at different C-Rates. For 24V battery, multiply voltage on Y-axis by 2 for 48V battery, multiply voltage on Y-axis by 4 (Please note that X-axis shows % State of Charge. State of Discharge will be = 100% - % State of Charge). These curves will be referred to in subsequent explanations.

### Reduction in Usable Capacity at Higher Discharge Rates – Typical in Inverter Application

As stated above, the rated capacity of the battery in Ah is normally applicable at a discharge rate of 20 Hours. As the discharge rate is increased as in cases where the inverters are driving higher capacity loads, the usable capacity reduces due to "Peukert Effect". This relationship is not linear but is more or less according to the Table 7.3 (page 19).

## SECTION 7 | General Information on Batteries for Powering Inverters

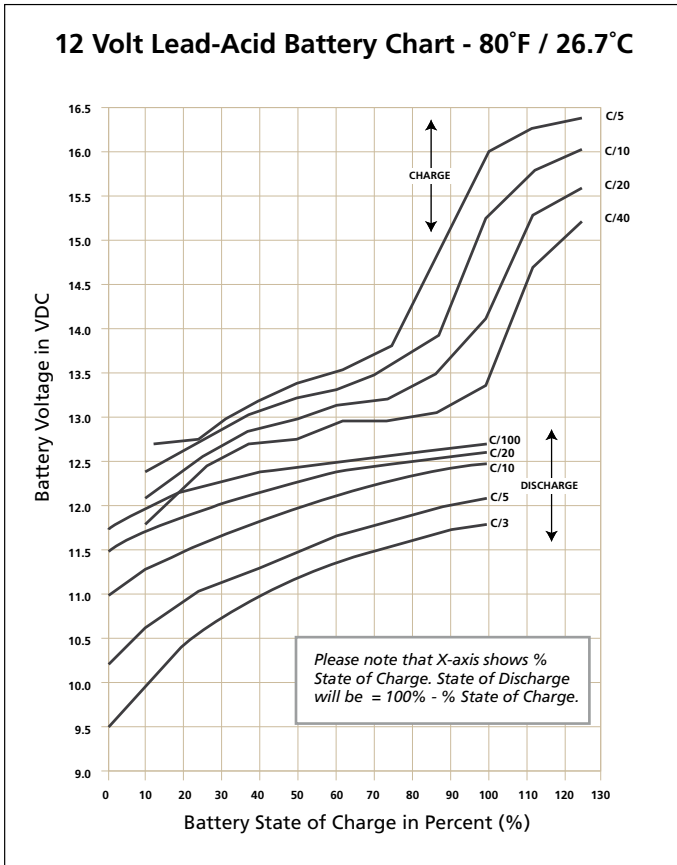

Fig. 7.1: Charging / Discharging Curves for 12V Lead Acid Battery

<b>TABLE 7.3 BATTERY CAPACITY VERSUS RATE OF DISCHARGE – C-RATE</b>	
<b>C-Rate Discharge Current</b>	<b>Usable Capacity (%)</b>
C/20	100%
C/10	87%
C/8	83%
C/6	75%
C/5	70%
C/3	60%
C/2	50%
1C	40%

## SECTION 7 | General Information on Batteries for Powering Inverters

Table 7.3 (page 19) will show that a 100 Ah capacity battery will deliver 100% (i.e. full 100 Ah) capacity if it is slowly discharged over 20 hours at the rate of 5 Amperes (50W output for a 12V inverter and 100W output for a 24V inverter). However, if it is discharged at a rate of 50 Amperes (500W output for a 12V inverter and 1000W output for a 24V inverter) then theoretically, it should provide  $100 \text{ AH} \div 50 = 2$  hours. However, the Table above shows that for 2 hours discharge rate, the capacity is reduced to 50% i.e. 50 Ah. Therefore, at 50 Ampere discharge rate (500W output for a 12V inverter and 1000W output for a 24V inverter) the battery will actually last for  $50 \text{ Ah} \div 50 \text{ Amperes} = 1$  Hour.

### State of Charge (SOC) of a Battery – Based on “Standing Voltage”

The “Standing Voltage” of a battery under open circuit conditions (no load connected to it) can approximately indicate the State of Charge (SOC) of the battery. The “Standing Voltage” is measured after disconnecting any charging device(s) and the battery load(s) and letting the battery “stand” idle for 3 to 8 hours before the voltage measurement is taken. Table 7.4 below shows the State of Charge versus Standing Voltage for a 12V battery system at 80°F (26.7°C). For 24-volt systems, multiply by 2; for 48-volt systems, multiply by 4.

Percentage of Full Charge	Standing Voltage of 6 Cell, 12V Nominal Battery	Standing Voltage of Individual Cells
100%	12.63V	2.105V
90%	12.6V	2.10V
80%	12.5V	2.08V
70%	12.3V	2.05V
60%	12.2V	2.03V
50%	12.1V	2.02V
40%	12.0V	2.00V
30%	11.8V	1.97V
20%	11.7V	1.95V
10%	11.6V	1.93V
0%	= / < 11.6V	= / < 1.93V

Check the individual cell voltages / specific gravity. If the inter cell voltage difference is more than a 0.2 V, or the specific gravity difference is 0.015 or more, the cells will require equalization. ***Please note that only the non-sealed / vented / flooded / wet cell batteries are equalized. Do not equalize sealed / VRLA type of AGM or Gel Cell Batteries.***

### State of Discharge of a loaded battery – Low Battery / DC Input Voltage Alarm and Shutdown in Inverters

Most inverter hardware estimate the State of Discharge of the loaded battery by measuring the voltage at the inverter’s DC input terminals (considering that the DC input

## SECTION 7 | General Information on Batteries for Powering Inverters

cables are thick enough to allow a negligible voltage drop between the battery and the inverter) .

Inverters are provided with a buzzer alarm to warn that the loaded battery has been deeply discharged to around 80% of the rated capacity. **Normally, the buzzer alarm is triggered when the voltage at the DC input terminals of the inverter has dropped to around 10.5V for a 12V battery or 21V for 24V battery at C-Rate discharge current of C/5 Amps and electrolyte temp. of 80°F.** The inverter is shut down if the terminal voltage at C/5 discharge current falls further to 10V for 12V battery (20V for 24V battery).

The State of Discharge of a battery is estimated based on the measured terminal voltage of the battery. The terminal voltage of the battery is dependent upon the following:

- **Temperature of the battery electrolyte:** Temperature of the electrolyte affects the electrochemical reactions inside the battery and produces a Negative Voltage Coefficient – during charging / discharging, the terminal voltage drops with rise in temperature and rises with drop in temperature
- **The amount of discharging current or “C-Rate”:** A battery has non linear internal resistance and hence, as the discharge current increases, the battery terminal voltage decreases non-linearly

The discharge curves in Fig. 7.1 (page 19) show the % State of Charge versus the terminal voltage of a 12V battery under different charge /discharge currents, i.e. “C-Rates” and fixed temperature of 80°F. (Please note that the X-Axis of the curves shows the % of State of Charge. The % of State of Discharge will be 100% - % State of Charge).

### Low DC Input Voltage Alarm in Inverters

As stated earlier, the buzzer alarm is triggered when the voltage at the DC input terminals of the inverter has dropped to around 10.5V for a 12V battery (21V for 24V battery) at C-Rate discharge current of C/5 Amps. Please note that the terminal voltage relative to a particular of State Discharge decreases with the rise in the value of the discharge current. For example, terminal voltages for a State of Discharge of 80% (State of Charge of 20%) for various discharge currents will be as follows (Refer to Fig. 7.1, page 19):

Discharge Current: C-Rate	Terminal Voltage at 80% State of Discharge (20% SOC)	Terminal Voltage When Completely Discharged (0% SOC)
C/3 A	10.45V	09.50V
C/5 A	10.90V	10.30V
C/10 A	11.95V	11.00V
C/20 A	11.85V	11.50V
C/100 A	12.15V	11.75V

## SECTION 7 | General Information on Batteries for Powering Inverters

In the example given above, the 10.5V Low Battery / DC Input Alarm would trigger at around 80% discharged state (20% SOC) when the C-Rate discharge current is C/5 Amps. However, for lower C-Rate discharge current of C/10 Amps and lower, the battery will be almost completely discharged when the alarm is sounded. **Hence, if the C-Rate discharge current is lower than C/5 Amps, the battery may have completely discharged by the time the Low DC Input Alarm is sounded.**

**Low DC Input Voltage Shut-down in Inverters:** As explained above, at around 80% State of Discharge of the battery at C-Rate discharge current of around C/5 Amps, the Low DC Input Voltage Alarm is sounded at around 10.5V for a 12V battery (at around 21V for 24V battery) to warn the user to disconnect the battery to prevent further draining of the battery. If the load is not disconnected at this stage, the batteries will be drained further to a lower voltage and to a completely discharged condition that is harmful for the battery and for the inverter.

Inverters are normally provided with a protection to shut down the output of the inverter if the DC voltage at the input terminals of the inverter drops below a threshold of around 10V for a 12V battery (20V for 24V battery). Referring to the Discharge Curves given in Fig 7.1 (page 19), the State of Discharge for various C-Rate discharge currents for battery voltage of 10V is as follows: (Please note that the X-Axis of the curves shows the % of State of Charge. The % of State of Discharge will be 100% - % State of Charge):

- 85% State of Discharge (15% State of Charge) at very high C-rate discharge current of C/3 Amps.
- 100% State of Discharge (0 % State of Charge) at high C-Rate discharge current of C/5 Amps.
- 100% discharged (0% State of charge) at lower C-rate Discharge current of C/10 Amps.

It is seen that at DC input voltage of 10V, the battery is completely discharged for C-rate discharge current of C/5 and lower.

**In view of the above, it may be seen that a fixed Low DC Input Voltage Alarm is not useful.** Temperature of the battery further complicates the situation. All the above analysis is based on battery electrolyte temperature of 80°F. The battery capacity varies with temperature. Battery capacity is also a function of age and charging history. Older batteries have lower capacity because of shedding of active materials, sulfation, corrosion, increasing number of charge / discharge cycles etc. Hence, the State of Discharge of a battery under load cannot be estimated accurately. However, the low DC input voltage alarm and shut-down function are designed to protect the inverter from excessive current drawn at the lower voltage.

### Use of External Programmable Low Voltage Disconnects

The above ambiguity can be removed by using an external, programmable Low Voltage Disconnect where more exact voltage threshold can be set to disconnect the battery based on the actual application requirements.

## SECTION 7 | General Information on Batteries for Powering Inverters

Please consider using the following Programmable Low Battery Cut-off / "Battery Guard" Models manufactured by Samlex America, Inc. [www.samlexamerica.com](http://www.samlexamerica.com)

- BG-40 (40A) – For up to 400W, 12V inverter or 800W, 24V inverter
- BG-60 (60A) - For up to 600W, 12V inverter or 1200W, 24V inverter
- BG-200 (200A) - For up to 2000W, 12V inverter or 4000W, 24V inverter

### Depth of Discharge of Battery and Battery Life

The more deeply a battery is discharged on each cycle, the shorter the battery life. Using more batteries than the minimum required will result in longer life for the battery bank. A typical cycle life chart is given in the Table 7.5 below:

Depth of Discharge % of Ah Capacity	Cycle Life of Group 27 /31	Cycle Life of Group 8D	Cycle Life of Group GC2
10	1000	1500	3800
50	320	480	1100
80	200	300	675
100	150	225	550

**NOTE:** It is recommended that the depth of discharge should be limited to 50%.

### Series and Parallel Connection of Batteries

#### Series Connection

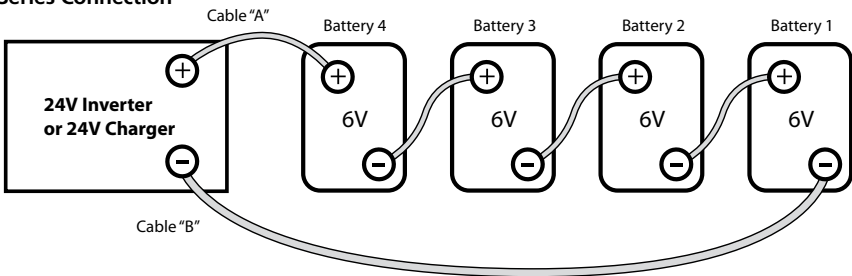

Fig 7.2: Series Connection

When two or more batteries are connected in series, their voltages add up but their Ah capacity remains the same. Fig. 7.2 above shows 4 pieces of 6V, 200 Ah batteries connected in series to form a battery bank of 24V with a capacity of 200 Ah. The Positive terminal of Battery 4 becomes the Positive terminal of the 24V bank. The Negative terminal of Battery 4 is connected to the Positive terminal of Battery 3. The Negative

## SECTION 7 | General Information on Batteries for Powering Inverters

terminal of Battery 3 is connected to the Positive terminal of Battery 2. The Negative terminal of Battery 2 is connected to the Positive terminal of Battery 1. The Negative terminal of Battery 1 becomes the Negative terminal of the 24V battery bank.

### Parallel Connection

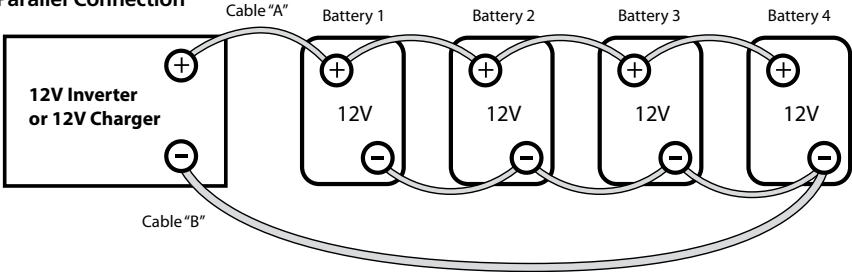

Fig 7.3: Parallel Connection

When two or more batteries are connected in parallel, their voltage remains the same but their Ah capacities add up. Fig. 7.3 above shows 4 pieces of 12V, 100 Ah batteries connected in parallel to form a battery bank of 12V with a capacity of 400 Ah. The four Positive terminals of Batteries 1 to 4 are paralleled (connected together) and this common Positive connection becomes the Positive terminal of the 12V bank. Similarly, the four Negative terminals of Batteries 1 to 4 are paralleled (connected together) and this common Negative connection becomes the Negative terminal of the 12V battery bank.

### Series – Parallel Connection

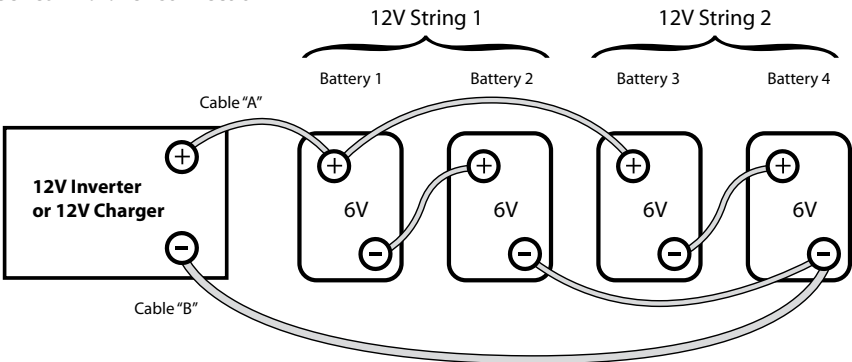

Fig. 7.4: Series-Parallel Connection

Figure 7.4 above shows a series – parallel connection consisting of four 6V, 200 AH batteries to form a 12V, 400 Ah battery bank. Two 6V, 200 Ah batteries, Batteries 1 and 2



## SECTION 7 | General Information on Batteries for Powering Inverters

are connected in series to form a 12V, 200 Ah battery (String 1). Similarly, two 6V, 200 Ah batteries, Batteries 3 and 4 are connected in series to form a 12V, 200 Ah battery (String 2). These two 12V, 200 Ah Strings 1 and 2 are connected in parallel to form a 12V, 400 Ah bank.



### CAUTION!

When 2 or more batteries / battery strings are connected in parallel and are then connected to an inverter or charger (See Figs 7.3 and 7.4 given above), attention should be paid to the manner in which the charger / inverter is connected to the battery bank. Please ensure that if the Positive output cable of the battery charger / inverter (Cable "A") is connected to the Positive battery post of the first battery (Battery 1 in Fig 7.3) or to the Positive battery post of the first battery string (Battery 1 of String 1 in Fig. 7.4), then the Negative output cable of the battery charger / inverter (Cable "B") should be connected to the Negative battery post of the last battery (Battery 4 as in Fig. 7.3) or to the Negative Post of the last battery string (Battery 4 of Battery String 2 as in Fig. 7.4). This connection ensures the following:

- The resistances of the interconnecting cables will be balanced.
- All the individual batteries / battery strings will see the same series resistance.
- All the individual batteries will charge / discharge at the same charging current and thus, will be charged to the same state at the same time.
- None of the batteries will see an overcharge condition.

### Sizing the Inverter Battery Bank

One of the most frequently asked questions is, "how long will the batteries last?" This question cannot be answered without knowing the size of the battery system and the load on the inverter. Usually this question is turned around to ask "How long do you want your load to run?", and then specific calculation can be done to determine the proper battery bank size.

There are a few basic formulae and estimation rules that are used:

1. Active Power in Watts (W) = Voltage in Volts (V) x Current in Amperes (A) x Power Factor
2. For an inverter running from a 12V battery system, the DC current required from the 12V batteries is the AC power delivered by the inverter to the load in Watts (W) divided by 10 & for an inverter running from a 24V battery system, the DC current required from the 24V batteries is the AC power delivered by the inverter to the load in Watts (W) divided by 20.
3. Energy required from the battery = DC current to be delivered (A) x time in Hours (H).

## SECTION 7 | General Information on Batteries for Powering Inverters

The first step is to estimate the total AC watts (W) of load(s) and for how long the load(s) will operate in hours (H). The AC watts are normally indicated in the electrical nameplate for each appliance or equipment. In case AC watts (W) are not indicated, Formula 1 given above may be used to calculate the AC watts. The next step is to estimate the DC current in Amperes (A) from the AC watts as per Formula 2 above. An example of this calculation for a 12V inverter is given below:

**Let us say that the total AC Watts delivered by the 12V inverter = 1000W.**

Then, using Formula 2 above, the DC current to be delivered by the 12V batteries =  $1000W \div 10 = 100$  Amperes.

**Next, the energy required by the load in Ampere Hours (Ah) is determined.**

For example, if the load is to operate for 3 hours then as per Formula 3 above, the energy to be delivered by the 12V batteries =  $100 \text{ Amperes} \times 3 \text{ Hours} = 300$  Ampere Hours (Ah).

**Now, the capacity of the batteries is determined based on the run time and the usable capacity.**

From Table 7.3 "Battery Capacity versus Rate of Discharge", the usable capacity at 3 Hour discharge rate is 60%. Hence, the actual capacity of the 12V batteries to deliver 300 Ah will be equal to:  $300 \text{ Ah} \div 0.6 = 500$  Ah.

**And finally, the actual desired rated capacity of the batteries is determined** based on the fact that normally only 80% of the capacity will be available with respect to the rated capacity due to non availability of ideal and optimum operating and charging conditions. So the final requirements will be equal to:  $500 \text{ Ah} \div 0.8 = 625$  Ah (note that the actual energy required by the load was 300 Ah).

It will be seen from the above that the final rated capacity of the batteries is almost 2 times the energy required by the load in Ah. ***Thus, as a Rule of Thumb, the Ah capacity of the batteries should be twice the energy required by the load in Ah.***

For the above example, the 12V batteries may be selected as follows:

- Use 6 Group 27/31, 12V, 105 Ah batteries in parallel to make up 630 Ah, or
- Use 3 Group 8D, 12V, 225 Ah batteries in parallel to make up 675 Ah.

## SECTION 8 | Installation



### WARNING!

1. Before commencing installation, please read the safety instructions explained in the Section titled "Safety Instructions" on page 3.
2. It is recommended that the installation should be undertaken by a qualified, licensed / certified electrician.
3. Various recommendations made in this manual on installation will be superseded by the National / Local Electrical Codes related to the location of the unit and the specific application.

### Location of Installation

Please ensure that the following requirements are met:

**Cool:** Heat is the worst enemy of electronic equipment. Hence, please ensure that the unit is installed in a cool area that is also protected against heating effects of direct exposure to the sun or to the heat generated by other adjacent heat generating devices.

**Well ventilated:** The unit is cooled by convection and by forced air-cooling by temperature controlled fans. The fans suck cool air from air intake openings on the front and bottom and expel hot air through the exhaust openings next to the fans. To avoid shut down of the inverter due to over temperature, do not cover or block these intake / exhaust openings or install the unit in an area with limited airflow. Keep a minimum clearance of 10" around the unit to provide adequate ventilation. If installed in an enclosure, openings must be provided in the enclosure, directly opposite to the air intake and exhaust openings of the inverter.

**Dry:** There should be no risk of condensation, water or any other liquid that can enter or fall on the unit.

**Clean:** The area should be free of dust and fumes. Ensure that there are no insects or rodents. They may enter the unit and block the ventilation openings or short circuit electrical circuits inside the unit.

**Protection against fire hazard:** The unit is not ignition protected and should not be located under any circumstance in an area that contains highly flammable liquids like gasoline or propane as in an engine compartment with gasoline-fueled engines. Do not keep any flammable / combustible material (i.e., paper, cloth, plastic, etc.) near the unit that may be ignited by heat, sparks or flames.

**Closeness to the battery bank:** Locate the unit as close to the battery bank as possible to prevent excessive voltage drop in the battery cables and consequent power loss and reduced efficiency. However, the unit should not be installed in the same compartment as the batteries (flooded or wet cell) or mounted where it will be exposed to corrosive acid fumes and flammable Oxygen and Hydrogen gases produced when the batteries are charged.

## SECTION 8 | Installation

The corrosive fumes will corrode and damage the unit and if the gases are not vented and allowed to collect, they could ignite and cause an explosion.

**Accessibility:** Do not block access to the front panel. Also, allow enough room to access the AC receptacles and DC wiring terminals and connections, as they will need to be checked and tightened periodically.

**Preventing Radio Frequency Interference (RFI):** The unit uses high power switching circuits that generate RFI. This RFI is limited to the required standards. Locate any electronic equipment susceptible to radio frequency and electromagnetic interference as far away from the inverter as possible. *Read Section 3, page 11 "Limiting Electromagnetic Interference (EMI)" for additional information.*

### Overall Dimensions

The overall dimensions and the location of the mounting slots are shown in Fig. 8.1.1 and 8.1.2 (page 29).

### Mounting Orientation

The unit has air intake and exhaust openings for the cooling fan(s). It has to be mounted in such a manner so that small objects should not be able to fall easily into the unit from these openings and cause electrical / mechanical damage. Also, the mounting orientation should be such that if the internal components overheat and melt / dislodge due to a catastrophic failure, the melted / hot dislodged portions should not be able to fall out of the unit on to a combustible material and cause a fire hazard. The size of openings has been limited as per the safety requirements to prevent the above possibilities when the unit is mounted in the recommended orientations. In order to meet the regulatory safety requirements, the mounting has to satisfy the following requirements:

- Mount on a non-combustible material.
- The mounting surface should be able to support the weight of the unit
- Mount horizontally on a horizontal surface - above a horizontal surface (e.g. table top or a shelf).
- Mount horizontally on a vertical surface – The unit can be mounted on a vertical surface (like a wall) with the fan axis horizontal (fan opening facing left or right).



### WARNING!

Mounting the unit vertically on a vertical surface is NOT allowed (fan opening facing up or down). As explained above, this is to prevent falling of objects into the unit through the fan opening when the fan opening faces up. If fan opening faces down, hot damaged component may fall out.

The surface of the unit is likely to be at an elevated temperature in conditions of higher load and higher ambient temperature. Hence, the unit should be installed in a manner where it is not likely to come in contact with any person.



## SECTION 8 | Installation

### DC Side Connections

#### Preventing DC Input Over Voltage

It is to be ensured that the DC input voltage of this unit does not exceed 16.5 VDC for the 12 -V battery versions and 33.0 VDC for the 24 -V battery versions to prevent permanent damage to the unit. Please observe the following precautions:

- Ensure that the maximum charging voltage of the external battery charger / alternator / solar charge controller does not exceed 16.5 VDC for the 12V battery version and 33.0 VDC for the 24 -V battery version
- Do not use unregulated solar panels to charge the battery connected to this unit. Under open circuit conditions and in cold ambient temperatures, the output of the solar panel may be > 44 VDC. Always use a charge controller between the solar panel and the battery.
- When using Diversion Charge Control Mode in a charge controller, the solar / wind / hydro source is directly connected to the battery bank. In this case, the controller will divert excess current to an external load. As the battery charges, the diversion duty cycle will increase. When the battery is fully charged, all the source energy will flow into the diversion load if there are no other loads. The charge controller will disconnect the diversion load if the current rating of the controller is exceeded. Disconnection of the diversion load may damage the battery as well as the inverter or other DC loads connected to the battery due to high voltages generated during conditions of high winds (for wind generators), high water flow rates (for hydro generators). It is, therefore, to be ensured that the diversion load is sized correctly to prevent the above over voltage conditions.
- Do not connect this unit to a battery system with a voltage higher than the rated battery input voltage of the unit (e.g. do not connect the 12V version of the unit to 24V or 48V Battery System)

#### Preventing Reverse Polarity on the Input Side



##### CAUTION!

Damage caused by reverse polarity is not covered by warranty! When making battery connections on the input side, make sure that the polarity of battery connections is correct (Connect the Positive of the battery to the Positive terminal of the unit and the Negative of the battery to the Negative terminal of the unit). If the input is connected in reverse polarity, DC fuse(s) inside the inverter will blow and may also cause permanent damage to the inverter.

#### Connection from the Batteries to the DC Input Side of the Unit – Wire and External Fuse Sizes



##### WARNING!

The input section of the inverter has large capacitors connected across the input terminals. As soon as the DC input connection loop (Battery (+) terminal ► External fuse ► Positive input terminal of the inverter ► Negative input

## SECTION 8 | Installation

terminal of the inverter ► Battery (-) terminal) is completed, these capacitors will start charging and the unit will momentarily draw very heavy current that will produce sparking on the last contact in the input loop even when the ON/OFF switch on the inverter is in the OFF position. Ensure that the external fuse is inserted only after all the connections in the loop have been completed so that the sparking is limited to the fuse area.

The flow of electric current in a conductor is opposed by the resistance of the conductor. The resistance of the conductor is directly proportional to the length of the conductor and inversely proportional to its cross-section (thickness). The resistance in the conductor produces undesirable effects of voltage drop and heating. Thus, thicker and shorter conductors are desirable.

The size (thickness / cross-section) of the conductors is designated by AWG (American Wire Gauge). Please note that a smaller AWG # denotes a thicker size of the conductor up to AWG #1. Wires thicker than AWG #1 are designated AWG 1/0, AWG 2/0, AWG 3/0 and so on. In this case, increasing AWG # denotes thicker wire.

The DC input circuit is required to handle very large DC currents and hence, the size of the wires and connectors should be selected to ensure minimum voltage drop between the battery and the inverter. Thinner wires and loose connections will result in poor inverter performance and will produce abnormal heating leading to risk of insulation melt down and fire. Normally, the thickness of the wire should be such that the voltage drop due to the current & the resistance of the length of the wire should be less than 2%. Use oil resistant, multi-stranded copper wire wires rated at 90°C minimum. Do not use aluminum wire as it has higher resistance per unit length. Wires can be bought at a marine / welding supply store.

Effects of low voltage on common electrical loads are given below:

- **Lighting circuits - Incandescent and Quartz Halogen:** A 5% voltage drop causes an approximate 10% loss in light output. This is because the bulb not only receives less power, but the cooler filament drops from white-hot towards red-hot, emitting much less visible light.
- **Lighting circuits - Fluorescent:** Voltage drop causes a nearly proportional drop in light output.
- **AC induction motors:** These are commonly found in power tools, appliances, well pumps etc. They exhibit very high surge demands when starting. Significant voltage drop in these circuits may cause failure to start and possible motor damage.
- **PV battery charging circuits:** These are critical because voltage drop can cause a disproportionate loss of charge current to charge a battery. A voltage drop greater than 5% can reduce charge current to the battery by a much greater percentage.

### Fuse Protection In Battery Circuits

A battery is an unlimited source of current. Under short circuit conditions, a battery can supply thousands of Amperes of current. If there is a short circuit along the length of

## SECTION 8 | Installation

the cables that connects the battery to the inverter, thousands of Amperes of current can flow from the battery to the point of shorting and that section of the wire will become red-hot, the insulation will melt and the cable will ultimately break. This interruption of very high current will generate a hazardous, high temperature, high-energy arc with accompanying high-pressure wave that may cause fire, damage nearby objects and cause injury. To prevent occurrence of hazardous conditions under short circuit conditions, an appropriate fuse should be used in the battery circuit that will limit the current, blow in a very short time and quench the arc in a safe manner. For this purpose, UL Class T fuse or equivalent with Ampere Interrupting Capacity (AIC) of at least 10,000A should be used (As per UL Standard 248-15). This special purpose current limiting, very fast acting fuse will blow in less than 8 ms under short circuit conditions. Appropriate capacity of the above Class T fuse should be installed within 7" / 178mm of the battery Plus (+) Terminal. The fuse will require a corresponding fuse holder.



### WARNING!

Use of an appropriately sized external fuse as described above is mandatory to provide safety against fire hazard due to accidental short circuit in the battery wires. Please note that the DC side fuse(s) inside the unit are designed to provide protection to the internal components of the inverter. These fuses will NOT blow if there is a short circuit along the length of wires connecting the battery and the inverter.

### Recommended Sizes of Wires and External Fuses

The following sizes of wires and external fuses are recommended. The distance of 3 ft. (.91 metres) / 6 ft. (1.83 metres) / 10 ft. (3.05 metres) is the distance between the battery and the inverter. The running length of routing of the wire should be considered if the wiring run is not straight but circuitous. The recommended size of wires will limit the voltage drop to 2% of the nominal battery voltage (0.24V for 12V battery and 0.48V for the 24V battery)

The length of the wire for calculating voltage drop has been taken as 2 times the distance between the inverter and the battery assuming that 2 lengths of wires (one Positive and one Negative) are used for the connection. DC resistance values are based on uncoated, stranded copper conductors at a temperature of 167°F / 75°C. This temperature is typical of operating power circuits.

Model No.	Maximum DC input current at rated output power & minimum rating of external fuse	Size of Wire			Samlex America DC Install Kit
		0.91M / 3 ft.	1.83M / 6 ft.	3.05M / 10 ft.	
PST-1500-12	200A	AWG #1/0	AWG #2/0	AWG #4/0	DC-2500-KIT
PST-1500-24	100A	AWG #4	AWG #4	AWG #2	DC-1000-KIT
PST-2000-12	240A	AWG #2/0	AWG #2/0	AWG #4/0	DC-2500-KIT
PST-2000-24	120A	AWG #4	AWG #4	AWG #2	DC-1000-KIT



## SECTION 8 | Installation

---

### \* TABLE (page 32) NOTES:

1. The ampere carrying capacity (Ampacity) of various sizes of wires is based on NEC Table 310.17 for single, insulated conductors in free air at 104°F / 40°C ambient. The size is based on the fuse rating.
2. The wire size is based on allowable ampacity or 2% voltage drop, whichever is thicker.
3. Four standard models of Samlex America, Inc. DC Installation Kits are available to cover installation requirements of 600 to 3500W inverters. Voltage drop of 2% or less will be applicable for 3 ft. (.91 metres) distance. In some cases the kits may contain thicker cables and higher rated fuses than the minimum sizes recommended. Thicker cables will produce lower voltage drop and hence, will further improve the overall efficiency. Also, voltage drop may be > 2% in some cases for distances > 3 ft. (.91 metres).

### DC Input Connection

The DC input terminals for battery connection (8 & 9 in Fig. 6.1) have nut and bolt connection - bolt size is 5/16" (18 Threads per Inch). Use ring tongue type of terminals on the wire ends to fit 5/16" bolt size.

### Reducing RF Interference

Please comply with recommendations given in Section 3 on page 11 - "Limiting Electro-magnetic Interference".

### AC SIDE CONNECTIONS



#### **WARNING! Preventing Paralleling of the AC Output**

1. The AC output of the inverter cannot be synchronized with another AC source and hence, it is not suitable for paralleling. The AC output of the inverter should never be connected directly to an electrical breaker panel / load center which is also fed from the utility power/ generator. Such a connection will result in parallel operation and AC power from the utility / generator will be fed back into the inverter which will instantly damage the output section of the inverter and may also pose a fire and safety hazard. If an electrical breaker panel / load center is being fed from the utility power / generator and the inverter is required to feed this panel as backup power source, the AC power from the utility power/ generator and the inverter should first be fed to a manual selector switch / Automatic Transfer Switch and the output of the manual selector switch / Automatic Transfer Switch should be connected to the electrical breaker panel / load center.
2. To prevent possibility of paralleling and severe damage to the inverter, never use a simple jumper cable with a male plug on both ends to connect the AC output of the inverter to a handy wall receptacle in the home / RV.

### AC Output Connection Through Ground Fault Circuit Interrupter (GFCI)

An un-intentional electric path between a source of current and a grounded surface is referred to as a "Ground Fault". Ground faults occur when current is leaking somewhere. In effect, electricity is escaping to the ground. How it leaks is very important. If

## SECTION 8 | Installation

your body provides a path to the ground for this leakage (dry human body has a low resistance of only around 1 K Ohm), you could be injured, burned, severely shocked or electrocuted. A Ground Fault Circuit Interrupter (GFCI) protects people from electric shock by detecting leakage and cutting off the AC source.

The AC output of this inverter is available through a NEMA5-20R GFCI Duplex Receptacle and also through hardwiring terminal connections located in a compartment behind the GFCI receptacle (please see Fig 6.1, Ref#13). The Neutral slot of this receptacle (longer rectangular slot) is internally bonded to the metal chassis of the inverter.

There is a Green indicator light that will be lighted when the GFCI is operating normally. The light will switch OFF if the GFCI is tripped.

The GFCI is provided with the following buttons:

- **Reset Button:** In case the GFCI is tripped, it can be reset by pressing the "Reset Button".

NOTE: For the Reset Button to operate, the inverter has to be in ON condition.

- **Test Button:** This button is used to test if the GFCI is operating normally. Test the GFCI periodically to ensure that it is operating normally.

The GFCI will trip due to the following conditions:

- Leakage or ground fault
- Neutral to Ground bonding (connection) on the load side of the GFCI



### CAUTION!

Do not feed the output from the GFCI receptacle to a Breaker Panel / Load Center where the Neutral is bonded to the Earth Ground. This will trip the GFCI. If the AC output is required to be fed to a Breaker Panel / Load Center, use hardwiring connections (please see details given below).

### AC Output Connections for Hardwiring

For connecting the AC output of the inverter to an AC Distribution Panel / Load Center, separate connections are available for hard wiring. Please refer to Fig 6.1. Compartment (13) contains terminals for AC output. The compartment is covered by Cover Plate (12) with the help of 4 screws. AC output connections are as follows:

#### Line "L" (15) and Neutral "N" (16) Terminals.

Please note that Line terminal "L" (15) of the AC Terminal Block and the Line terminal on the Line side of the GFCI are internally connected together at the PCB. Similarly, Neutral terminal "N" (16) on the AC Terminal Block and the Neutral terminal on the Line side of the GFCI are internally connected together at the PCB

- Hole diameter: 4 mm / 0.16"
- Set screw: #6 (UNF, 40 Threads per Inch) or M3.5 ( Coarse Pitch 0.6 mm)

## SECTION 8 | Installation

### AC Ground Terminal (14)

- Stud: #6 (UNC, 32 Threads Per Inch)

### Neutral to Chassis Ground Bonding

- Neutral "N" (16) is bonded to the metal chassis of the inverter through a loop of wire connecting the "N" terminal on the Line side of the GFCI to the chassis of the inverter.



#### WARNING!

RISK OF ELECTRIC SHOCK. When this unit is installed in vehicles and hard-wiring connection is used to feed the AC output of the inverter to the AC Distribution Panel / Load Center in the vehicle, it is to be ensured that Ground Fault Circuit Interrupter(s) [GFCI] are installed in the vehicle wiring system to protect all Branch Circuits.

The following GFCIs have been tested to operate satisfactorily and are acceptable. Other types may fail to operate properly when connected to this inverter:

Mfr. of GFCI	Mfr.'s Model No.	Description
Pass & Seymour	2095 Series	NEMA5-20 Duplex 20A
Leviton	7899 Series	NEMA5-20 Duplex 20A
Zhejiang Trimone	TGM20 Series	NEMA5-20 Duplex 20A

### AC Output Cable Sizing & Conductor Termination for Hard-wiring

Use 3 conductor cable with at least 90 C insulation rating. Based on the maximum output current of 12.5 A for PST-1500 and 16.7 A for PST-2000, the minimum size of each of the 3 conductors of the AC output cable should be AWG #12 for both the inverters. This is the minimum size recommended in NEC Table 310.17 for up to 20 A over current protection. For firm connection when using set screw type of terminals, use Insulated Pin Type of Terminals for termination of the Line and Neutral conductors and Non Insulated Ring Type of Terminal for the Grounding conductor. For convenience, the following terminals have been provided:

**For Line and Neutral wires:** Nylon Insulated, Cord End Terminals for AWG #12 wire 2 pieces

**For Neutral wire:** Non Insulated Ring Terminal for #6 stud 1 piece

Use proper crimping Tool to crimp the terminals to the bare ends of the wire. Make sure that the connections are tight and firm. Please ensure that the AC cable is adequately clamped by the metal Strain Relief Clamp (11).

Please use the following type designation of AC cord: "SE, SEOO, ST, STO, SJ, SJEOO, SJT, or SJTO."

### Grounding to Earth or to other designated ground

For safety, ground the metal chassis of the inverter to the Earth Ground or to the other designated ground (For example, in a mobile RV, the metal frame of the RV is normally

## SECTION 9 | Operation

designated as the negative DC ground). An equipment grounding Lug (7) has been provided for grounding the metal chassis of the inverter to the appropriate ground.

When using the inverter in a building, connect a 10 mm<sup>2</sup> or AWG #8 insulated stranded copper wire from the above equipment grounding lug to the Earth Ground connection ( a connection that connects to the Ground Rod or to the water pipe or to another connection that is solidly bonded to the Earth Ground ). The connections must be tight against bare metal. Use star washers to penetrate paint and corrosion.

When using the inverter in a mobile RV, connect a 10 mm<sup>2</sup> or AWG #8 insulated stranded copper wire from the above equipment grounding lug to the appropriate ground bus of the RV (usually the vehicle chassis or a dedicated DC ground bus). The connections must be tight against bare metal. Use star washers to penetrate paint and corrosion.

### Optional Wired Remote Control

An optional Wired Remote Control Model No. RC-200 (with 16.5 ft. / 5 metre cable), is available for switching ON and switching OFF. The remote has LCD display showing AC output V, A, Hz, W, VA and Power Factor. It also has LED indications similar to the indications on the front panel (2, 3, 4 in Fig. 61). Read Remote Control Manual for details.

### Powering On The Loads

After the inverter is switched on, it takes a finite time to become ready to deliver full power. Hence, always switch on the load(s) after a few seconds of switching on the inverter. Avoid switching on the inverter with the load already switched on. This may prematurely trigger the overload protection.

When a load is switched on, it may require initial higher power surge to start. Hence, if multiple loads are being powered, they should be switched on one by one so that the inverter is not overloaded by the higher starting surge if all the loads are switched on at once.

### Switching The Inverter ON/OFF

Before switching on the inverter, check that all the AC loads have been switched off. The ON/OFF switch (1) on the front panel of the inverter is used to switch on and switch off the inverter. This switch operates a low power control circuitry, which in turn controls all the high power circuitry. Optional Remote Control Model RC-200 may also be used for ON/OFF control.



#### CAUTION!

Please note that the ON/OFF switch is not switching the high power battery input circuit. Parts of the DC side circuit will still be alive even when the switch is in the OFF position. Hence, disconnect the DC and AC sides before working on any circuits connected to the inverter.

## SECTION 9 | Operation

When the inverter is switched ON, the GREEN "Power ON" LED (2, Fig. 6.1) will be lighted. This LED indicates that the input section of the inverter is operating normally. Under normal operating conditions, AC output voltage will now be available at the GFCI Duplex Receptacle (5). The Green indicator light on the GFCI will be lighted.

Switch on the AC load(s). The GREEN "Power ON" LED (2) and the indication light on the GFCI should remain lighted for normal operation of the load.

### Temperature Controlled Cooling Fans

Two cooling fans are thermostatically controlled. Temperature of a critical hot spot inside the inverter is monitored to activate the fans and the over temperature shut-down. When the temperature of this hot spot reaches 118.4°F / 48°C, the fans are switched ON. The fans will be automatically switched OFF once the hot spot cools down to 107.6°F / 42°C. Please note that the fans may not come on at low loads or if the ambient temperature is cooler. This is normal.

### Indications For Normal Operation

When the inverter is operating normally and supplying AC load(s), the GREEN "Power ON" LED (2) and the indication light on the GFCI will be lighted. *Please see under "Protection Against Abnormal Conditions" and "Troubleshooting Guide" for symptoms of abnormal operation.*

### No Load Draw (Idle Current)

When the ON/OFF switch is turned on, all the circuitry inside the inverter becomes alive and the AC output is made available. In this condition, even when no load is being supplied (or, if a load is connected but has been switched OFF), the inverter draws a small amount of current from the batteries to keep the circuitry alive and ready to deliver the required power on demand. This is called the "idle current" or the "no load draw". Hence, when the load is not required to be operated, turn OFF the ON/OFF switch on the inverter to prevent unnecessary current drain from the battery.



#### INFO

When the inverter is turned OFF using the optional Remote Control RC-200, some control circuitry in the inverter is still alive and will draw very low current. Therefore, to prevent any drain from the battery, switch OFF the inverter from the ON/OFF switch provided on the front panel of the inverter.

## SECTION 10 | Protections

The inverter has been provided with protections detailed below:

### Overload / Short Circuit Shut Down

The inverter can provide higher than normal instantaneous power (< 1 second) limited to the surge power rating of the inverter. Also, the inverter can provide continuous power limited to the continuous power rating of the inverter. If there is an overload beyond these specified limits, the AC output of the unit will be shut down permanently. RED LED marked "overload" will turn ON, the GREEN indication on the GFCI will be OFF and buzzer alarm will sound. The GREEN "Power ON" LED (2) will continue to be lighted. The unit will be latched in this shutdown condition and will require manual reset. To reset, switch OFF the power ON/OFF switch, wait for 3 minutes and then switch ON again. Before switching ON again, remove the cause of the shutdown.

### Warning Alarm - Low DC Input Voltage

The voltage at the DC input terminals will be lower than the voltage at the battery terminals due to voltage drop in the battery wires and connectors. The drop in the voltage at the DC input terminals of the inverter could be due to lower battery voltage or due to abnormally high drop in the battery wires if the wires are not thick enough (*Please see page 31 "Connection From the Batteries To the DC Input Side of The Unit – Wire and External Fuse Sizes"*). If the voltage at the DC input terminals falls below 10.5V for 12V versions or 21.0V for 24V versions, a buzzer alarm will be sounded. The GREEN "Power ON" LED (2) and indication light on the GFCI will continue to be lighted and the AC output voltage would continue to be available. This warning buzzer alarm indicates that the battery is running low and that the inverter will be shut down after sometime if the voltage at the inverter terminals further drops to 10 V for 12 V versions or 20V for 24V versions.

### Low DC Input Voltage Shut Down

If the voltage at the DC input terminals falls below 10V for 12V versions or 20V for 24V versions, the AC output is shut down. Buzzer alarm is sounded. The GREEN "Power ON" LED (2) will remain lighted. The GREEN indication light on the GFCI will be OFF.

The unit will reset automatically when the DC input voltage rises > 11.5V for 12V versions and > 23V for 24V versions

### High DC Input Voltage Shutdown

If the voltage at the DC input terminals exceeds 16.5V for 12V versions or 33V for 24V versions, the inverter will be shut down temporarily. Buzzer alarm will be sounded. The GREEN "Power ON" LED (2) will remain lighted. The GREEN indicator light on the GFCI will be OFF. The unit will be reset automatically when the voltage drops down to < 16.5V for 12V versions and to < 33V for 24V versions.

## SECTION 10 | Protections

### Over-Temperature Shut Down

In case of failure of the cooling fans or in the case of inadequate heat removal due to higher ambient temperatures / insufficient air exchange, the temperature inside the unit will increase. The temperature of a critical hot spot inside the inverter is monitored and at 203°F / 95°C, the AC output of the inverter is shut down temporarily. Buzzer alarm will be sounded. The GREEN "Power ON" LED (2) will remain lighted. The GREEN indication light on the GFCI will be OFF.

The unit will automatically reset after the hot spot has cooled down to 158°F / 70°C.

### Internal DC Side Fuses

The following DC side fuses have been provided for internal protection of the DC input side. The fuses are 32V, Automotive Type Blade Fuses, Type "ATC" by Cooper Bussmann or equivalent:

PST-1500-12: 5 pieces of 40A in parallel = 200A total

PST-1500-24: 5 pieces of 20A in parallel = 100A total

PST-2000-12: 6 pieces of 40A in parallel = 240A total

PST-2000-24: 6 pieces of 20A in parallel = 120A total

### Reverse Polarity at the DC Input Terminals

The Positive of the battery should be connected to the Positive DC input terminal of the inverter and the Negative of the battery should be connected to the Negative DC input terminal of the inverter. A reversal of polarity (the Positive of the battery wrongly connected to the Negative DC input terminal of the inverter and the Negative of the battery wrongly connected to the Positive DC input terminal of the inverter) will blow the external / internal DC side fuses. If the DC side fuse is blown, the inverter will be dead. The Status LED (2) and the GREEN indication light on the GFCI will be switched OFF and there will be no AC output.



#### INFO

Reverse polarity connection is likely to damage the DC input circuitry. The internal fuse(s) should be replaced with the same size of fuse(s) used in the unit. If the unit does not work after replacing the fuse(s), it has been permanently damaged and will require repair / replacement (*Please read Section 11 - "Troubleshooting Guide" for more details*).



#### CAUTION!

Damage caused by reverse polarity is not covered by warranty! When making battery connections on the input side, make sure that the polarity of battery connections is correct (Connect the Positive of the battery to the Positive terminal of the unit and the Negative of the battery to the Negative terminal of the unit). If the input is connected in reverse polarity, DC fuse(s) inside the inverter / external fuse will blow and may also cause permanent damage to the inverter.

## SECTION 11 | Trouble Shooting Guide

ISSUE	POSSIBLE CAUSE	REMEDY
<p>When switched ON, The GREEN "Power ON" LED (2) does not light. Buzzer is OFF. There is no AC output voltage. GREEN indication light on the GFCI is OFF.</p>	<p>There is no voltage at the DC input terminals / 12V power outlet in the vehicle</p>	<p>Check the continuity of the battery input circuit.</p> <p>Check that the internal/external battery fuse/ vehicle fuse for 12V power outlet is intact. Replace if blown. When powered from 12V power outlet in the vehicle, ensure that the AC load is less than 150W.</p> <p>Check that all connections in the battery input circuit are tight.</p>
	<p>Polarity of the DC input voltage has been reversed that has blown the external / internal DC side fuses (Note: Reverse polarity may cause permanent damage).</p>	<p>Check external and internal fuses. Internal fuses may be soldered and may not be easily replaceable. Replace fuses. If unit does not work, call Technical Support for repair.</p>
<p>Low AC output voltage (No buzzer alarm).</p>	<p>Low input voltage at the inverter terminals and the load is close to the maximum allowable power.</p>	<p>Check that the battery is fully charged. Re-charge, if low.</p> <p>Check that the battery cables are thick enough to carry the required current over the required length. Use thicker cables, if required.</p> <p>Tighten connections of battery input circuit.</p> <p>Reduce load.</p>
<p>Buzzer alarm is sounded when load is switched ON. Voltage at DC input terminals reads between 10 to 10.5V for 12V versions and between 20 to 21.0V for 24V versions. The GREEN "Power ON" LED (2) is lighted. Indication light on the GFCI is GREEN. AC output voltage is available.</p>	<p>DC input voltage is less than 10.5V for 12V versions and less than 21.0V for 24V versions.</p>	<p>Check that the battery is fully charged. Re-charge, if low.</p> <p>Check that the battery cables are thick enough to carry the required current over the required length. Use thicker cables, if required.</p> <p>Tighten connections of the battery input circuit.</p>
<p>Buzzer alarm is sounded when load is switched ON. Voltage at the DC input terminals reads below 10V for 12V versions and below 20V for 24V versions. The GREEN "Power ON" LED (2) is lighted. GREEN indication light on the GFCI is OFF. There is no AC output.</p>	<p>Shut-down due to low DC input voltage - Less than 10V for 12V versions and less than 20V for 24V versions.</p>	<p>Check that the battery is fully charged. Re-charge, if low.</p> <p>Check that the battery cables are thick enough to carry the required current over the required length. Use thicker cables, if required.</p> <p>Tighten connections of the battery input circuit.</p>



## SECTION 11 | Trouble Shooting Guide

ISSUE	POSSIBLE CAUSE	REMEDY
<p>There is no AC output. The GREEN "Power ON" LED (2) is lighted. Buzzer is ON. GREEN indication light on the GFCI is OFF.</p>	<p>Shut-down due to high input DC voltage – &gt; 16.5V for 12V versions and &gt; 33V for 24V versions.</p>	<p>Check that the voltage at the DC input terminals is less than 16.5V for 12V versions and less than 33V for 24V versions.</p> <p>Ensure that the maximum charging voltage of the battery charger / alternator / solar charge controller is below 16.5V for 12V versions and below 33V for 24V versions.</p> <p>Ensure that an unregulated solar panel is not used to charge a battery. Under cold ambient temperatures, the output of the solar panel may exceed 22V for 12V system or 42V for 24 V system. Ensure that a charge controller is used between the solar panel and the battery.</p>
<p>AC output shuts down completely. Red "Overload" LED (3) is lighted. Buzzer is ON. The GREEN "Power ON" LED (2) is lighted. GREEN indication light on the GFCI is OFF.</p>	<p>Permanent shut-down of the AC output due to continuous overload beyond the continuous power rating of the inverter.</p>	<p>Reduce the load.</p> <p>The load is not suitable as it requires higher power to operate. Use an inverter with higher power rating.</p> <p>If the unit goes into permanent overload again after resetting and removing the load completely, the unit has become defective. Call Technical support.</p> <p><b>NOTE:</b> The unit will be latched in this shut-down condition and will require manual reset.</p> <p>To reset, switch OFF the power ON/OFF switch, wait for 3 minutes and then switch ON again.</p> <p>Before switching on again, remove the cause of the shut-down.</p>
<p>There is no AC output. Buzzer alarm is sounded. Red "Over temperature" LED (4) is lighted. The GREEN "Power ON LED (2) is lighted. GREEN indication light on the GFCI is OFF.</p>	<p>Shut-down due to over temperature because of fan failure or inadequate cooling as a result of high ambient temperature or insufficient air exchange</p>	<p>Check that the fans are working. If not, the fan control circuit may be defective. Call Technical Support.</p> <p>If the fans are working, check that the ventilation slots on the suction side and the openings on the discharge side of the fans are not obstructed.</p> <p>If the fans are working and the openings are not obstructed, check that enough cool replacement air is available. Also check that the ambient air temperature is less than 40°C.</p> <p>Reduce the load to reduce the heating effect.</p> <p>After the cause of overheating is removed and the unit cools down sufficiently, it will reset automatically.</p>
<p>There is no AC output. GREEN indication on the GFCI is OFF. The GREEN "Power ON" LED (2) is lighted. No buzzer alarm.</p>	<p>GFCI has tripped due to leakage or due to Neutral to Ground bond on the load side.</p>	<p>Check load side circuits for leakage or Neutral to Ground bonding and correct. Press "Reset Button" on the GFCI to reset. Ensure that the inverter is ON before re-setting.</p>

## SECTION 12 | Specifications

MODEL NO.	PST-1500-12	PST-1500-24
<b>OUTPUT</b>		
OUTPUT VOLTAGE	120 VAC ± 3%	120 VAC ± 3%
MAXIMUM OUTPUT CURRENT	12.5A	12.5A
OUTPUT FREQUENCY	60 Hz ± 1%	60 Hz ± 1%
TYPE OF OUTPUT WAVEFORM	Pure Sine Wave	Pure Sine Wave
TOTAL HARMONIC DISTORTION OF OUTPUT WAVEFORM	< 3%	< 3%
CONTINUOUS OUTPUT POWER (At Power Factor = 1)	1500 Watts	1500 Watts
SURGE OUTPUT POWER (At Power Factor = 1; <1 sec)	3000 Watts	3000 Watts
PEAK EFFICIENCY (At full load)	85%	85%
AC OUTPUT CONNECTIONS	(i) NEMA5-20R GFCI Duplex Receptacle (ii) Terminal block for hardwiring: <b>Hole diameter</b> (4 mm / 0.16") & <b>Set Screw</b> (#6 x 40TPI or M3.5 x 0.6 mm Pitch)	
<b>INPUT</b>		
NOMINAL DC INPUT VOLTAGE	12V	24V
DC INPUT VOLTAGE RANGE	10.7 - 16.5 VDC	21.4 - 33 VDC
MAXIMUM INPUT CURRENT	200A	100A
DC INPUT CURRENT AT NO LOAD	1.0A	0.8A
DC INPUT CONNECTIONS	Bolt & nut: 5/16" x 18 TPI	
DC INPUT FUSES (INTERNAL)	5 X 40A = 200A (Each Type ATC, 32V, 40A)	5 x 20A = 100A (Each Type ATC, 32V, 20A)
<b>LED DISPLAY</b>		
Power, Overload, Over Temperature		
<b>PROTECTIONS</b>		
LOW DC INPUT VOLTAGE ALARM	10.7V	21.4V
LOW DC INPUT VOLTAGE SHUTDOWN	10V	20V
HIGH DC INPUT VOLTAGE SHUTDOWN	16.5V	33V
SHORT CIRCUIT SHUTDOWN	Yes	Yes
OVERLOAD SHUTDOWN	Yes	Yes
GROUND FAULT SHUTDOWN	Yes	Yes
OVER TEMPERATURE SHUTDOWN	Yes	Yes
REVERSE POLARITY ON DC INPUT SIDE	Yes	Yes
<b>WIRED REMOTE CONTROL (OPTIONAL)</b>		RC-200 (Sold separately)
<b>FORCED AIR COOLING</b>		2 Temperature Controlled Fans
<b>COMPLIANCE</b>		
SAFETY	Intertek - ETL Listed. Conforms to ANSI/UL Standard 458.	
EMI / EMC	FCC Part 15(B), Class B	
<b>ENVIRONMENT</b>		
OPERATING TEMPERATURE RANGE	32°F to 104°F / 0 to 40°C	
<b>DIMENSIONS AND WEIGHTS</b>		
(L X W X H), MM	468.2 x 263 x 105.6	468.2 x 263 x 105.6
(L X W X H), INCHES	18.43 x 10.35 x 4.16	18.43 x 10.35 x 4.16
KG	7.1	7.1
LBS	15.6	15.6

See Specification Table Cautions (page 43)

## SECTION 12 | Specifications



### CAUTION! RISK OF FIRE

Do not replace any vehicle fuse with a rating higher than recommended by the vehicle manufacturer. This product is rated to draw 200 Amperes from 12V battery vehicle outlet and 100 Amperes from 24V battery vehicle outlet. Ensure that the electrical system in your vehicle can supply this product without causing the vehicle fusing to open. This can be determined by making sure that the fuse in the vehicle, which protects the outlet, is rated higher 200 amperes (12V battery), or 100 amperes (24V battery). Information on the vehicle fuse ratings is typically found in the vehicle operator's manual. If a vehicle fuse opens repeatedly, do not keep on replacing it. The cause of the overload must be found. On no account should fuses be patched up with tin foil or wire as this may cause serious damage elsewhere in the electrical circuit or cause fire.

## SECTION 12 | Specifications

MODEL NO.	PST-2000-12	PST-2000-24
<b>OUTPUT</b>		
OUTPUT VOLTAGE	120 VAC ± 3%	120 VAC ± 3%
MAXIMUM OUTPUT CURRENT	16.7A	16.7A
OUTPUT FREQUENCY	60 Hz ± 1%	60 Hz ± 1%
TYPE OF OUTPUT WAVEFORM	Pure Sine Wave	Pure Sine Wave
TOTAL HARMONIC DISTORTION OF OUTPUT WAVEFORM	< 3%	< 3%
CONTINUOUS OUTPUT POWER (At Power Factor = 1)	2000 Watts	2000 Watts
SURGE OUTPUT POWER (At Power Factor = 1; <1 sec)	3500 Watts	3500 Watts
PEAK EFFICIENCY (At full load)	85%	85%
AC OUTPUT CONNECTIONS	(i) NEMA5-20R GFCI Duplex Receptacle (ii) Terminal block for hardwiring: <b>Hole diameter</b> (4 mm / 0.16") & <b>Set Screw</b> (#6 x 40TPI or M3.5 x 0.6 mm Pitch)	
<b>INPUT</b>		
NOMINAL DC INPUT VOLTAGE	12V	24V
DC INPUT VOLTAGE RANGE	10.7 - 16.5 VDC	21.4 - 33 VDC
MAXIMUM INPUT CURRENT	240A	120A
DC INPUT CURRENT AT NO LOAD	< 1.0A	< 0.8A
DC INPUT CONNECTIONS	Bolt & nut: 5/16" x 18 TPI	
DC INPUT FUSES (INTERNAL)	6 X 40A = 240A (Each Type ATC, 32V, 40A)	6 x 20A = 120A (Each Type ATC, 32V, 20A)
<b>LED DISPLAY</b>		Power, Overload, Over Temperature
<b>PROTECTIONS</b>		
LOW DC INPUT VOLTAGE ALARM	10.7V	21.4V
LOW DC INPUT VOLTAGE SHUTDOWN	10V	20V
HIGH DC INPUT VOLTAGE SHUTDOWN	16.5V	33V
SHORT CIRCUIT SHUTDOWN	Yes	Yes
OVERLOAD SHUTDOWN	Yes	Yes
GROUND FAULT SHUTDOWN	Yes	Yes
OVER TEMPERATURE SHUTDOWN	Yes	Yes
REVERSE POLARITY ON DC INPUT SIDE	Yes	Yes
<b>WIRED REMOTE CONTROL (OPTIONAL)</b>	RC-200 (Sold separately)	
<b>FORCED AIR COOLING</b>	2 Temperature Controlled Fans	
<b>COMPLIANCE</b>		
SAFETY	Intertek - ETL Listed. Conforms to ANSI/UL Standard 458.	
EMI / EMC	FCC Part 15(B), Class B	
<b>ENVIRONMENT</b>		
OPERATING TEMPERATURE RANGE	32°F to 104°F / 0 to 40°C	
<b>DIMENSIONS AND WEIGHTS</b>		
(L X W X H), MM	468.2 x 263 x 105.6	468.2 x 263 x 105.6
(L X W X H), INCHES	18.43 x 10.35 x 4.16	18.43 x 10.35 x 4.16
KG	7.1	7.1
LBS	15.6	15.6

See Specification Table Cautions (page 45)

## SECTION 12 | Specifications



### CAUTION! RISK OF FIRE

Do not replace any vehicle fuse with a rating higher than recommended by the vehicle manufacturer. This product is rated to draw 240 Amperes from 12V vehicle outlet and 120 Amperes from 24V battery vehicle outlet. Ensure that the electrical system in your vehicle can supply this product without causing the vehicle fusing to open. This can be determined by making sure that the fuse in the vehicle, which protects the outlet, is rated higher 240 amperes (12V battery), or 120 amperes (24V battery). Information on the vehicle fuse ratings is typically found in the vehicle operator's manual. If a vehicle fuse opens repeatedly, do not keep on replacing it. The cause of the overload must be found. On no account should fuses be patched up with tin foil or wire as this may cause serious damage elsewhere in the electrical circuit or cause fire.

## **SECTION 13 | Warranty**

### **2 YEAR LIMITED WARRANTY**

The PST-1500-12, PST-1500-24, PST-2000-12 and PST-2000-24 are manufactured by Samlex America, Inc. (the "Warrantor") is warranted to be free from defects in workmanship and materials under normal use and service. The warranty period is 2 years for the United States and Canada, and is in effect from the date of purchase by the user (the "Purchaser").

Warranty outside of the United States and Canada is limited to 6 months. For a warranty claim, the Purchaser should contact the place of purchase to obtain a Return Authorization Number.

The defective part or unit should be returned at the Purchaser's expense to the authorized location. A written statement describing the nature of the defect, the date of purchase, the place of purchase, and the Purchaser's name, address and telephone number should also be included.

If upon the Warrantor's examination, the defect proves to be the result of defective material or workmanship, the equipment will be repaired or replaced at the Warrantor's option without charge, and returned to the Purchaser at the Warrantor's expense. (Contiguous US and Canada only)

No refund of the purchase price will be granted to the Purchaser, unless the Warrantor is unable to remedy the defect after having a reasonable number of opportunities to do so. Warranty service shall be performed only by the Warrantor. Any attempt to remedy the defect by anyone other than the Warrantor shall render this warranty void. There shall be no warranty for defects or damages caused by faulty installation or hook-up, abuse or misuse of the equipment including exposure to excessive heat, salt or fresh water spray, or water immersion.

No other express warranty is hereby given and there are no warranties which extend beyond those described herein. This warranty is expressly in lieu of any other expressed or implied warranties, including any implied warranty of merchantability, fitness for the ordinary purposes for which such goods are used, or fitness for a particular purpose, or any other obligations on the part of the Warrantor or its employees and representatives.

There shall be no responsibility or liability whatsoever on the part of the Warrantor or its employees and representatives for injury to any persons, or damage to person or persons, or damage to property, or loss of income or profit, or any other consequential or resulting damage which may be claimed to have been incurred through the use or sale of the equipment, including any possible failure of malfunction of the equipment, or part thereof. The Warrantor assumes no liability for incidental or consequential damages of any kind.

**Samlex America Inc. (the "Warrantor")**  
**[www.samlexamerica.com](http://www.samlexamerica.com)**



# Contact Information

## Toll Free Numbers

Ph: 800 561 5885

Fax: 888 814 5210

## Local Numbers

Ph: 604 525 3836

Fax: 604 525 5221

## Website

[www.samlexamerica.com](http://www.samlexamerica.com)

## USA Shipping Warehouse

Kent WA

## Canadian Shipping Warehouse

Delta BC

Email purchase orders to  
[orders@samlexamerica.com](mailto:orders@samlexamerica.com)



**samlex**america®