



Car Radio | CD | USB | Bluetooth

Heidelberg 220 BT
Stuttgart 120

1 011 200 212 / 1 011 200 213

1 011 200 202 / 1 011 200 203



www.blaupunkt.com

Operating and installation instructions

 **BLAUPUNKT**

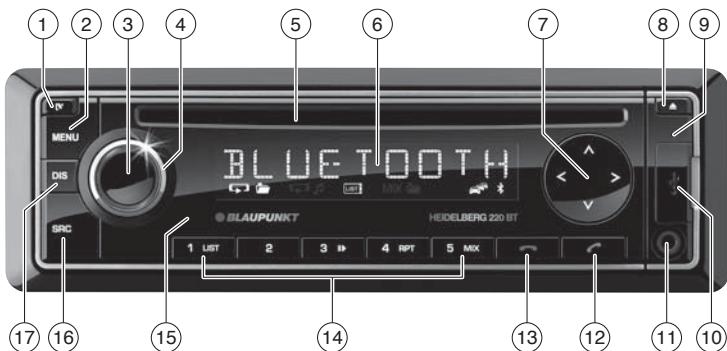

- ① **🔒** button
Unlock the detachable control panel
- ② **MENU** button
Short press: Call up/close menu
Long press: Start scan function
- ③ On/Off button
Short press: Switch on car sound system
In operation: Mute car sound system (Mute)
Long press: Switch off car sound system
- ④ Volume control
In the menu: Change settings
Fast-Browse mode: Select folder and track (Heidelberg 220 BT only)
- ⑤ CD tray
- ⑥ Display
- ⑦ **▲ / ▼** button
In the menu: Select menu item
Radio mode: Start seek tuning
MP3/WMA mode: Change to next/previous folder
</> button
In the menu: Change menu level
Radio mode: Adjust the stations
Other operating modes: Track selection
- ⑧ **▲** button (Eject)
Eject a CD
- ⑨ Microphone (Heidelberg 220 BT only)
- ⑩ USB socket
- ⑪ Front AUX-IN socket
- ⑫ **☎** button (Heidelberg 220 BT only)
Short press: Answering a call, speed dial
Long press: Activate voice dialing
- ⑬ **☎** button (Heidelberg 220 BT only)
Ending/rejecting a phone call
- ⑭ Keys **1 - 5** (Heidelberg 220 BT)
Keys **1 - 7** (Stuttgart 120)
- ⑮ Infrared receiver
- ⑯ **SRC** button
Select memory bank or audio source
- ⑰ **DIS** button
Switch display

Safety notes	4	Fast searching	11
Symbols used	4	Interrupting playback	11
Road safety	4	Scanning all tracks	11
General safety notes	4	Playing tracks in random order	12
Declaration of conformity	5	Repeatedly playing individual tracks or directories	12
Cleaning notes	5	Switching display	12
Disposal notes	5	Browse mode (Heidelberg 220 BT only)	12
Scope of delivery	5	Bluetooth® (Heidelberg 220 BT only)	13
Optional equipment (not part of the scope of delivery)	5	The Bluetooth® menu	13
Placing the device in operation	5	Pairing and connecting a device	14
Attaching/detaching the control panel	5	Telephone functions	15
Setting the reception area	6	Bluetooth® streaming mode	17
Switching on/off	6	Additional functions in the Bluetooth® menu	17
Volume	6	External audio sources	18
Switching demo mode on/off	6	Front AUX-IN socket	18
Traffic information	7	Sound settings	19
Radio mode	7	Calling and exiting the "AUDIO" menu	19
RDS	7	Making settings in the "AUDIO" menu	19
Changing to radio mode or selecting a memory bank	7	User settings	20
Tuning into a station	8	Calling the user menu and selecting a menu	20
Storing stations or calling stored stations	8	Making settings in the "TUNER" menu	20
Scanning stations	8	Making settings in the "DISPLAY" menu	21
Storing stations automatically (Travelstore)	8	Making settings in the "VOLUME" menu	22
PTY	9	Making settings in the "CLOCK" menu	22
Switching display	9	Making settings in the "VARIOUS" menu	23
CD/MP3/WMA mode	10	Factory settings	23
Basic information	10	Useful information	24
Changing to CD/MP3/WMA mode	10	Warranty	24
Inserting/ejecting a CD	10	Service	24
Connecting/removing a USB data carrier	11	Technical data	24
Selecting tracks	11	Installation instructions	25
Selecting a folder (only in MP3/WMA mode)	11		

Safety notes

The car sound system was manufactured according to the state of the art and established safety guidelines. Even so, dangers may occur if you do not observe the safety notes in these instructions.

These instructions contain important information to easily and safely install and operate the car sound system.

- Read these instructions carefully and completely before using the car sound system.
- Keep the instructions at a location so that they are always accessible to all users.
- Always pass on the car sound system to third parties together with these instructions.

In addition, observe the instructions of the devices used in conjunction with this car sound system.

Symbols used

These instructions employ the following symbols:



DANGER!

Warns about injuries



CAUTION!

Warns about damaging the CD drive



DANGER!

Warns about high volume



The CE mark confirms the compliance with EU directives.

➔ Identifies a sequencing step

- Identifies a listing

Road safety

Observe the following notes about road safety:

- **Use your device in such a way that you can always safely control your vehicle.** In case of doubt, stop at a suitable location and operate your device while the vehicle is standing.
- **Remove or attach the control panel only while the vehicle is standing.**
- **Always listen at a moderate volume** to protect your hearing and to be able to hear acoustic warning signals (e.g. police sirens). During mute phases (e.g. when changing the audio source), changing the volume is not audible. Do not increase the volume during this mute phase.

General safety notes

Observe the following notes to protect yourself against injuries:

- **Do not modify or open the device.** The device contains a Class 1 laser that can cause injuries to your eyes.
- **Do not increase the volume during mute phases**, e.g. when changing the audio source. Changing the volume is not audible during a mute phase. Do not increase the volume during mute phases, e.g. when changing the audio source.

Use as directed

This car sound system is intended for installation and operation in a vehicle with 12 V vehicle system voltage and must be installed in a DIN slot. Observe the performance limits in the technical data. Repairs and installation, if necessary, should be performed by a specialist.

Installation instructions

You may only install the car sound system yourself if you are experienced in installing car sound systems and are very familiar with the electrical system of the vehicle. For this purpose, observe the installation instructions at the end of these instructions.

Declaration of conformity

The Blaupunkt AudioVision GmbH & Co. KG declares that the car sound system Stuttgart 120 complies with the basic requirements and the other relevant regulations of the directive 2004/108/EEC and the car sound system Heidelberg 220 BT complies with the basic requirements and the other relevant regulations of the directive 1999/5/EC.

The declaration of conformity can be found on the Internet under www.blaupunkt.com.

Cleaning notes

Solvents, cleaning and scouring agents as well as dashboard spray and plastics care product may contain ingredients that will damage the surface of the car sound system.

- Use only a dry or slightly moistened cloth for cleaning the car sound system.
- If necessary, clean the contacts of the control panel regularly using a soft cloth moistened with cleaning alcohol.

Disposal notes



Do not dispose of your old unit in the household trash!

Use the return and collection systems available to dispose of the old device.

Scope of delivery

The scope of delivery includes:

- 1 Car sound system
- 1 Operating/installation instructions
- 1 Support frame
- 2 Disassembly tools

Extended scope of delivery

(only for 1 011 200 203 / 1 011 200 213):

- 1 Handheld remote control (incl. battery)
- 1 Connecting cable chamber A
- 1 Connecting cable chamber B
- 1 Antenna connection adapter

Optional equipment (not part of the scope of delivery)

Use only accessories approved by Blaupunkt. Information is available from your Blaupunkt specialised dealer or on the Internet under www.blaupunkt.com.

Placing the device in operation

Attention

Transport securing screws

Before the startup of the car sound system, ensure that the transport securing screws are removed (see the chapter "Installation instructions").

Attaching/detaching the control panel

The car sound system is equipped with a detachable control panel (release panel) to protect your equipment against theft. To start operating the radio after installation, you must first attach the control panel (see the section "Attaching the control panel" in this chapter).

Always take the control panel with you when leaving the vehicle. The car sound system is worthless to a thief without this control panel.

Caution

Damage to the control panel

Never drop the control panel.

Transport the control panel so that it is protected against impacts and the contacts cannot become dirty.

Do not expose the control panel to direct sunlight or another heat source.

Avoid direct skin contact with the control panel's electrical contacts.

Attaching the control panel

- Push the control panel into the bracket at the right edge of the device.
- Push the control panel carefully into the left bracket until it clicks into place.

Removing the control panel

- Press the **[V]** button (1) to unlock the control panel.
The left side of the control panel detaches from the device and is secured by the bracket against falling out.
- Move the control panel slightly to the left until it disengages from the right bracket.
- Carefully remove the control panel from the left bracket.

Note:

The car sound system automatically switches off as soon as the control panel is removed.

Setting the reception area

This car sound system is designed for operation in different regions with different frequency ranges and station technologies. The factory default of the reception area is "EUROPE". In addition, the reception areas "USA", "S-AMERICA" and "THAILAND" are available.

Note:

If you operate the car sound system outside of Europe, you may first have to set a suitable reception area in the user menu (see the chapter "User settings", section "Making settings in the "TUNER" menu", menu item "AREA").

Switching on/off

Switching on/off with the On/Off button

- For switch-on, press the On/Off button (3).
The car sound system switches on.
- To switch off the device, press and hold down the On/Off button (3) for longer than 2 seconds.
The car sound system switches off.

Note:

If you switch on the car sound system while the vehicle ignition is switched off, it automatically switches off after 1 hour to preserve the vehicle battery.

Switching on/off via vehicle ignition

The car sound system will switch off/on simultaneously with the ignition if the device is correctly connected to the vehicle's ignition as shown in the installation instructions and you did not switch the device off by pressing the On/Off button (3).

Volume

Adjusting the volume

You can adjust the volume in steps from 0 (off) to 50 (maximum).

- Turn the volume control (4) to change the volume.

Note (Stuttgart 120):

If a telephone is connected with the car sound system as described in the installation instructions, the car sound system is muted in case of a phone call. During muting, the display shows "TELEPHONE".

Muting the car sound system (Mute)



- Briefly press the On/Off button (3) to mute the car sound system or to reactivate the previous volume.
During muting, the display shows "MUTE".

Switching demo mode on/off

The demo mode shows the functions of the car sound system as scrolling text on the display. You can turn the demo mode on or off:

- Switch off the car sound system if it is not already turned off.
- #### Stuttgart 120
- Press and hold the buttons **<** (7) and **6** (14) at the same time and press the On/Off button (3).

Heidelberg 220 BT

- Press and hold the buttons  (7) and  (13) at the same time and press the On/Off button  (3).

The car sound system switches on. The display briefly shows "DEMO MODE" if you switched on the demo mode. By pressing any button, the demo mode is interrupted and you can operate the device.

Traffic information

In the reception area "EUROPE", an FM station can identify traffic reports by means of an RDS signal. If priority for traffic reports is switched on, a traffic report is automatically switched through, even if the car sound system is currently not in radio mode.

If priority is switched on, the display shows the traffic jam symbol . "TRAFFIC" is displayed during a switched-through traffic announcement.

The priority is activated and deactivated in the user menu (see the chapter "User settings", section "Making settings in the "TUNER" menu", menu item "TRAFFIC").

Notes:

- The volume is increased for the duration of the switched-through traffic announcement. You can adjust the minimum volume for traffic announcements (see the chapter "User settings", section "Making settings in the "VOLUME" menu", menu item "TA VOLUME").
- To cancel a switched-through traffic announcement, press the **DIS** button .

Radio mode**RDS**

Many FM stations broadcast an RDS (Radio Data System) signal in addition to their programme in the reception area "EUROPE" that allows the following additional functions:

- The station name is shown on the display.
- The car sound system recognises traffic announcements and news broadcasts and can automatically switch them through in other operating modes (e.g. in CD mode).
- Alternate frequency: If RDS is activated, the car sound system automatically selects the best receivable frequency for the station that is currently set.
- Regional: At certain times, some radio stations divide their programme into regional programmes providing different content. If the REGIONAL function is activated, the car sound system changes only to those alternate frequencies on which the same regional programme is being broadcast.

The functions RDS and REGIONAL are activated and deactivated in the user menu (see the chapter "User settings", section "Making settings in the "TUNER" menu", menu items "RDS" and "REGIONAL").

Changing to radio mode or selecting a memory bank

The following memory banks are available in the different reception areas:

Region	Memory banks
EUROPE	FM1, FM2, FMT, MW
USA	FM1, FM2, FMT, AM, AMT
S-AMERICA	FM1, FM2, FMT, AM, AMT
THAILAND	FM1, FM2, FMT, AM, AMT

- Press the **SRC** button  (16) repeatedly until the desired memory bank is displayed.

Notes:

- Up to 5 stations (Heidelberg 220 BT) or up to 7 stations (Suttgart 120) can be stored in each memory bank.
- Memory banks can be activated or deactivated via the user menu (see the chapter "User settings", section "Making settings in the "TUNER" menu", menu item "TUN BAND" (band selection)). Deactivated memory banks are skipped during the source selection with the **SRC** button (16).

Tuning into a station

There are various ways of tuning into a station:

Tuning into stations manually

- Briefly press the **</>** button (7) once or several times to change the frequency in increments, or long to quickly change the frequency.

Note:

For the reception areas "EUROPE" and "USA": In the FM waveband, the current selected programme type is displayed and can be changed if the PTY function is activated (see the chapter "PTY").

Starting station seek tuning

- Press the **∇/▲** button (7) to start station seek tuning.

The radio tunes into the next receivable station.

Notes:

- For the reception area "EUROPE": In the FM waveband, only traffic information stations are tuned into if the priority for traffic information (🚗) is switched on.
- For the reception areas "EUROPE" and "USA": In the FM waveband, the next station with the currently selected programme type is tuned into if the PTY function is activated (see the chapter "PTY").

- The sensitivity of seek tuning can be adjusted (see the chapter "User settings", section "Making settings in the "TUNER" menu", menu item "SEEK SENS").

Storing stations or calling stored stations

- Select the desired memory bank.
- If necessary, set the desired station.
- Press a station buttons (14) for approx. 2 seconds to store the current station under the button.
- or -
- Briefly press a station button (14) to call up the stored station.

Scanning stations

The scan function is used to scan every receivable station of the current waveband.

Note:

You can adjust the scan time for each station (see the chapter "User settings", section "Making settings in the "VARIOUS" menu", menu item "SCAN TIME").

- Press the **MENU** button (2) for approx. 2 seconds to start scanning.

During the scan, the display alternately displays "SCAN" and the current frequency as well as memory bank or station name.

- Briefly press the **MENU** button (2) to continue listening to the station that is currently being received.

Storing stations automatically (Travelstore)

With Travelstore, you can automatically search for and store the 5 FM stations (Heidelberg 220 BT) or the 7 FM stations (Suttgart 120) offering the strongest reception in the region in one memory bank. Any previously stored stations in this memory bank are deleted in the process.

With Travelstore, you can store 5 or 7 FM stations in the FMT memory bank in all reception areas. In the reception areas "USA", "S-AMERICA" and "THAILAND", you can also store 5 or 7 AM stations in the AMT memory bank.

- Select a memory bank of the desired waveband, e.g. FM1 or AM.
- Press the **SRC** button (16) for approx. 2 seconds.

The tuner starts the automatic station seek tuning; the display shows "FM TSTORE" or "AM TSTORE". After the storing is completed, the radio plays the station at memory location 1 of the FMT or AMT level.

Notes:

- For the reception area "EUROPE": If the priority for traffic information is switched on () , only traffic information stations are stored.
- If the FMT or AMT memory bank is deactivated (see the chapter "User settings", section "Making settings in the "TUNER" menu", menu item "TUN BAND"), it is automatically reactivated if you initiate the Travelstore function.

PTY

In the reception areas "EUROPE" and "USA", an FM station can transmit its current programme type, e.g. CULTURE, POP, JAZZ, ROCK, SPORT or SCIENCE. Hence, the PTY function allows a targeted search for broadcasts of a certain programme type, e.g. for rock or sports broadcasts. Note that PTY is not supported by all stations.

Note:

The PTY function is only available if it has been activated (see the chapter "User settings", section "Making settings in the "TUNER" menu", menu item "PTY").

Selecting a programme type

- Briefly press the **</>** button (7).

The currently selected programme type is briefly displayed, and you can select a different programme type.

- If necessary, press the **</>** button (7) repeatedly until the desired programme type is selected.

Note:

In the reception area "EUROPE", you can adjust the language in which the programme types are displayed (see the chapter "User settings", section "Making settings in the "TUNER" menu", menu item "PTY LANG").

Searching for stations

- Press the **∇ / ▲** button (7).

During the seek tuning, the currently selected programme type is shown on the display.

As soon as a station with the desired programme type is found, it remains being tuned into.

Notes:

- If no station with the selected programme type is found, "PTY NONE" is briefly displayed and 1 beep can be heard. The radio will then retune to the station that it played last.
- If the tuned radio station or another station on the broadcasting network broadcasts your selected programme type at a later point in time, the car sound system will automatically switch from the currently tuned station to the station whose programme type matches the one you selected. Note that this function is not supported by all stations.

Switching display

- Press the **DIS** button (17) to toggle between these two displays:

Display	Meaning
ABCDEF or FM1 102.90	Station name or Memory bank/frequency
FM1 18:30	Memory bank/time

CD/MP3/WMA mode

Basic information

This car sound system can be used to play audio CDs (CDDA) and CD-R/RWs with audio, MP3 or WMA files as well as MP3 or WMA files on USB data carriers.

Notes:

- To ensure proper functioning, use only CDs with the Compact-Disc logo.
- Blaupunkt cannot guarantee the flawless function of copy-protected CDs and all CD blanks and USB data carriers available on the market.

Note the following information when preparing an MP3/WMA data carrier:

- Naming of tracks and directories:
 - Max. 32 characters without the file extension ".mp3" or ".wma" (the use of more characters reduces the number of tracks and folders that the car sound system can recognise)
 - No umlauts or special characters
- CD formats: audio CD (CDDA), CD-R/RW, Ø: 12 cm
- CD data formats: ISO 9669 Level 1 and 2, Joliet
- CD burn speed: Max. 16x (recommended)
- USB format/file system: Mass storage device / FAT16/32
- File extension of audio files:
 - .MP3 for MP3 files
 - .WMA for WMA files
- WMA files only without Digital Rights Management (DRM) and created with Windows Media Player version 8 or later
- MP3 ID3 tags: Version 1 and 2
- Bitrate for creating audio files:
 - MP3: 32 to 320 kbps
 - WMA: 32 to 192 kbps
- Depending on the data structure on the USB medium, up to 20,000 entries can be managed.

Changing to CD/MP3/WMA mode

➤ Press the **SRC** button (16) repeatedly until the desired audio source is displayed:

- "CD": Inserted CD
- "USB": Connected USB data carrier
- "AUX": Connected external audio source

Notes:

- The respective audio source can be selected only if a corresponding data carrier is inserted or a corresponding device is connected.
- If the car sound system first has to read the data of a connected device or data carrier before the playback, the display shows "READING". The duration of the reading depends on the data volume and design of the device or data carrier. If the device or data carrier is defective or the transferred data cannot be played back, a corresponding message appears on the display (e.g. "USB ERROR").

Inserting/ejecting a CD

Inserting a CD



Risk of severe damage to the CD drive!

Noncircular contoured CDs (shape CDs) and CDs with a diameter of 8 cm (mini CDs) must not be used.

We accept no responsibility for any damage to the CD drive that may occur as a result of the use of unsuitable CDs.

Note:

You must not hinder or assist the drive as it automatically draws in the CD.

➤ Insert the CD with its printed side up into the CD tray (5) until you feel a slight resistance.

The drive automatically draws in the CD and checks its data. Afterwards, the playback starts in CD or MP3 mode.

Note:

If the inserted CD cannot be played back, "CD ERROR" is briefly displayed and the CD is automatically ejected after approx. 2 seconds.

Ejecting a CD**Note:**

You must not hinder or assist the drive as it ejects the CD.

- Press the ▲ button (8) to eject an inserted CD.

Notes:

- If a CD is ejected and not removed, the drive will automatically draw it back in again after approx. 10 seconds.
- You can also eject CDs while the car sound system is switched off or whilst another audio source is activated.

Connecting/removing a USB data carrier**Connecting a USB data carrier**

- Switch off the car sound system so that the data carrier will be correctly registered.
- Pull the protective cap of the USB socket (10) to the front until it moves out of the socket and fold it down.
- Connect the USB data carrier.
- Turn on the car sound system.

If the USB data carrier is initially selected as audio source, the data are read first.

Notes:

- If the connected USB data carrier cannot be seen, "USB ERROR" is briefly displayed.
- The time required for reading in the data depends on the design and size of the USB data carrier.

Removing a USB data carrier

- Switch off the car sound system so that the data carrier will be correctly unregistered.
- Disconnect the USB data carrier.
- Close the protective cap of the USB socket (10).

Selecting tracks

- Press the </> button (7) briefly to change to the previous/next track.

Note:

If the current track plays longer than 3 seconds, pressing <(7) once restarts the track.

Selecting a folder (only in MP3/WMA mode)

- Press the √/∧ button (7) briefly to change to the previous/next folder.

Fast searching

- Press and hold down the button </> (7) until the desired position has been reached.

Interrupting playback

- Press the 3▶ (14) button to interrupt the playback ("PAUSE") or to continue it.

Scanning all tracks

The scan function scans all available tracks.

- Press the MENU button (2) for approx. 2 seconds to start the scan, or briefly to continue playing the currently scanned track.

During the scan, the display alternately displays "SCAN" and the current track number or file name.

Note:

The scan time can be adjusted (see the chapter "User settings", section "Making settings in the "VARIOUS" menu", menu item "SCAN TIME").

Playing tracks in random order

- Press the **5 MIX** button  to change among the playback modes:



Operation	Display	Meaning
CD	MIX ALL	Mixing tracks
MP3/ WMA	MIX DIR	Mixing tracks of the current folder
	MIX ALL	Mixing tracks of the data carrier
Gen.	MIX OFF	Regular playback

If the MIX function is switched on, the icon **MIX** (mix all tracks) or **MIX**  (mix tracks of current folder) is shown on the display.

Repeatedly playing individual tracks or directories

- Press the **4 RPT** button  to change among the playback modes:

Operation	Display	Meaning
CD	RPT TRACK	Repeating tracks
MP3/ WMA	RPT TRACK	Repeating tracks
	RPT DIR	Repeating folders
Gen.	RPT OFF	Regular playback

If the RPT function is switched on, the icon  (repeat tracks) or  (repeat folders) is shown on the display.

Switching display

- Press the **DIS** button  once or several times to switch among these displays:

Operation	Display	Meaning
CD	T01 00:15	Track number and playing time
	T01 03:37	Track number and duration
	T01 18:30	Track number and time
MP3/ WMA	FILE	File name
	ARTIST	Artist*
	ALBUM	Album name*
	SONG	Track name*
	PLAY 00:15	Playing time
	TOTAL03:37	Track duration
	CLOCK18:30	Time



* Track name, artist and album name must be stored as ID3 tag to be able to display them.

Browse mode (Heidelberg 220 BT only)

In Browse mode, you can directly search for and select a certain track on the MP3/WMA data carrier without interrupting the current playback.

Calling the browse mode

- Press the **1 LIST** button  to call up the browse mode.

The **LIST**  icon flashes on the display. In addition, the icon  (folder) or icon  (track) appears. The first or current folder on the data carrier is being displayed.

Notes:

- The first folder is displayed only if the browse mode has been called for the first time after inserting or connecting the data carrier. Afterwards, the current folder is displayed whenever the browse mode is called.

- You can exit the browse mode at any time by pressing the **1 LIST** button (14).

➤ Press the **∇ / ▲** button (7) once or several times to select a different folder.

➤ Press the **>** button (7) to display the tracks of the selected folder.

The first track of the folder is shown on the display.

Note:

Pressing the **<** button (7) returns you to the folder list.

➤ Press the **∇ / ▲** button (7) once or several times to select a different track.

➤ Press the **>** button (7) to play the track.

The playback starts. You are exiting the browse mode.

Fast browsing

Fast browsing enables faster access to tracks. Instead of the arrow keys (7), you use the volume control (4) to select list entries:

Function	Browse mode	Fast browse mode
Selecting entries in lists	∇ / ▲ (7)	Volume control (4)
Confirming entries	> (7)	> (7)
Return to the higher level	< (7)	< (7)

Fast browsing is switched on or off in the user menu (see the chapter "User settings", section "Making settings in the "VARIOUS" menu", menu item "BROWSE").

Note:

With activated fast browsing, you cannot change the volume in browse mode. To do so, first exit the browse mode by pressing the button **1 LIST** (14) or starting the track playback.

Bluetooth® (Heidelberg 220 BT only)

You can connect the car sound system via Bluetooth® with other Bluetooth®-ready devices, such as cell phones or MP3 players. This allows you to use the car sound system with its integrated microphone as hands-free system for connected cell phones and control the audio output of other Bluetooth® devices and play them back via the loudspeakers of the car sound system (Bluetooth® streaming).

Bluetooth® technology is a wireless connection of short range. For this reason, Bluetooth® devices must be located near the car sound system (in the vehicle) to establish and maintain a connection.

To establish a Bluetooth® connection, you must first pair the car sound system and the Bluetooth® device. When you pair the devices, a Bluetooth® connection is subsequently established automatically. This connection remains in effect as long as the Bluetooth® device is within range. If the connection is interrupted, e.g. because you moved the cell phone outside the range, the connection is automatically re-established as soon as you are back within range.

You can connect only one cell phone and streaming device with the car sound system at a time. If you connect a new device with the car sound system, the connection to a currently connected device may automatically be interrupted. However, the car sound system leaves up to 5 different Bluetooth® devices paired, and you can quickly and easily connect any of these devices with the car sound system again.

The Bluetooth® menu

In the Bluetooth® menu, you find all the functions for pairing, connecting and managing Bluetooth® devices.

Calling the Bluetooth® menu

➤ Briefly press the **MENU** button (2) to open the user menu.

➤ Press the **∇ / ▲** button (7) repeatedly until the "BLUETOOTH" menu item is selected.

- Press the **>** button (7) to open the Bluetooth® menu.
- Press the **∨ / ∧** button (7) repeatedly until the desired menu item is selected.
- Perform the setting (see the following sections).
- Briefly press the **MENU** button (2) to exit the menu.

Notes:

- The Bluetooth® menu is automatically exited approx. 30 seconds after the last button activation and you are returned to the display of the current audio source.
- In the menu, you can press the button **<** (7) in each case to return to the higher menu level.
- If a Bluetooth® process is running (e.g. re-establishing the connection to the last connected device), the functions of the Bluetooth® menu are blocked. If you attempt to open the Bluetooth® menu during this time, "LINK BUSY" briefly appears on the display. If you want to cancel the Bluetooth® process and open the Bluetooth® menu, press the **⏪** button (13).

Pairing and connecting a device

Note:

You can pair up to 5 Bluetooth® devices with this car sound system. If you register a sixth one, the Bluetooth® device registered first is unregistered.

Pairing and connecting a cell phone

Note:

If a connection with a cell phone currently exists, this connection is automatically disconnected if you pair and connect another cell phone.

- In the Bluetooth® menu, select the "PAIRING" menu item.
- Press the **>** button (7) to pair a cell phone.

The display shows "PAIRING" and the Bluetooth® symbol  is flashing. The car sound system can now be recognised by a Bluetooth® cell phone for approx. 2 minutes and connected.

- Search the car sound system from your cell phone (Bluetooth® name: "BLAUPUNKT").

As soon as the car sound system is located by the cell phone and is to be connected, the display briefly shows "ENTER PIN" and the currently stored PIN (by default "1234").

- Establish the connection from your cell phone. Enter the PIN displayed by the car sound system.

The display may show "PAIRED", followed by "CONNECTED", as soon as the car sound system and the cell phone are paired and connected.

Notes:

- If no connection can be established, the display briefly shows "CONNECT FAILED".
- If the telephone connected last cannot be located after switching on the car sound system, the car sound system attempts to connect one of the other paired telephones. If none of the telephones can be located, the display briefly shows "NO DEVICE".

Pairing and connecting a Bluetooth® streaming device

Note:

If a connection with a streaming device currently exists, this connection is automatically disconnected if you pair and connect another streaming device.

- In the Bluetooth® menu, select the "PAIRING" menu item.
- Press the **>** button (7) to pair a streaming device.

The display shows the currently stored PIN (default "1234"). If required, enter the PIN of the streaming device:

- Turn the volume control (4) to select a digit for the respective position.
- Press the > or < button (7) to reach the next or previous position.
- Press the > button (7) repeatedly until you reach past the last position to confirm the PIN entered.

Note:

Not all streaming devices require the entry of a PIN on the car sound system. For some streaming devices, you have to enter the PIN of the car sound system instead. For these devices, press only the > button (7) repeatedly until you reach beyond the last position, thereby confirming the current PIN, and then enter this PIN on the streaming device.

The display shows "PAIRING" and the Bluetooth® symbol is flashing. The car sound system can now be recognised by the streaming device for approx. 2 minutes and connected.

- Search the car sound system from your streaming device (Bluetooth® name: "BLAUPUNKT") and establish the connection. Enter the PIN of the car sound system, if necessary.

The display may show "PAIRED", followed by "CONNECTED", as soon as the car sound system and the streaming device are paired and connected.

Notes:

- If no connection can be established, the display briefly shows "CONNECT FAILED".
- After switch-on, the car sound system automatically attempts to reconnect the device connected last. If the connection attempt fails, the display briefly shows "DISCONNECTED". If necessary, attempt to re-establish the connection from the streaming device.
- If the device connected last cannot be located after switching on the car sound system, the car sound system attempts to connect one of the other paired devices. If none of the devices is located, the display shows "NO DEVICE".



Telephone functions

Answering/rejecting an incoming phone call

With an incoming call, the display alternately shows "IN CALL" and the number of the caller. The current audio source is muted and a ring tone is played via the loudspeakers of the car sound system.

Note:

If the number of the caller is not being transmitted, the display shows "IN CALL" instead of the number. If the number of the caller is stored together with a name in the car sound system, the name of the entry and the number are displayed (see the section "Storing a phone number in the car sound system" in this chapter).

- Press the  button (12) to answer the call. "CALL" and the duration of the ongoing call are displayed.
- Press the  button (13) to reject the call or to end the current call.

The display shows "END CALL".

Notes:

- During the call, you can adjust the volume with the volume control (4) or mute the device with a short press of the On/Off button (3).
- You can preset the hands-free volume in the user menu (see the chapter "User settings", section "Making settings in the "VOLUME" menu", menu item "TEL VOLUME").

Making a call

- In the Bluetooth® menu, select the "DIAL NEW NUMBER" menu item.
- Press the > button (7) to open the entry menu.

You can now enter a phone number with up to 20 digits:
- Turn the volume control (4) to select a digit for the respective position.

- Press the > or < button (7) to reach the next or previous position.

Notes:

- You can also reach the next position by pressing the ON/Off button (3).
- While entering the phone number, you cannot change the volume or mute the car sound system.

- Press the  button (12) to call the number entered.

"CALLING" and the dialed number are alternately shown on the display.

As soon as your calling party answers the call, the display shows "CALL" and the time of the current phone call.

Upon ending the call, the display briefly shows "END CALL".

Making a call with voice dial

Note:

This function is only available if the connected cell phone supports voice dial.

- In the Bluetooth® menu, select the "VOICE DIAL" menu item.
- Press the > button (7) to activate voice recognition.
- or -
- Press the  button (12) for approx. 2 seconds to activate the voice recognition with the speed dial.

The car sound system is muted and the display shows "SPEAK NOW".

- Say the name of the desired calling partner.

Notes:

- If no Bluetooth® connection is established when voice recognition is activated, the display briefly shows "VOICE DIAL FAILED".
- If the spoken name is not being recognised or the time for the voice recognition has already expired, the display briefly shows "VOICE DIAL FAILED".

- You can cancel the voice recognition by pressing the  button (13).
- Please note that the duration of the voice recognition is limited and depending on the respective cell phone.

Storing a phone number in the car sound system

You can store five phone numbers in the car sound system and place calls with the speed dial (see the following section).

- Enter the phone number as described in the section "Making a call".
- Press the desired memory button 1 - 5 (14) for approx. 2 seconds to store the number.
You can now enter a name with up to 15 characters:
- Turn the volume control (4) to select a character for the respective position.
- Press the > or < button (7) to reach the next or previous position.

Note:

You can also reach the next position by pressing the ON/Off button (3).

- Press the memory button 1 - 5 (14) again for approx. 2 seconds to store the number and name.

The display briefly shows "NUMBER SAVED". Afterwards, you are returned to the Bluetooth® menu and the "DIAL NEW NUMBER" menu item.

Note:

A number previously stored on the memory button is replaced.

Speed dial for any phone number or for the number dialed last or a stored number

With speed dial, you can make a call without first having to select the corresponding function in the Bluetooth® menu.

To call the number dialed last,

- press the  button (12).

The display shows the number dialed last.

Note:

If no cell phone is currently connected, the Bluetooth® menu is opened. The "PAIRING" menu item is selected.

- Press the  button (12) to call the number. "CALLING" and the dialed number are alternately shown on the display.

To call a stored number,



- press the  button (12).
- Press a memory button 1 - 5 (14) to call the stored number.

Note:

If no number is stored under the selected memory button, the display briefly shows "NO NUMBER".

- Press the  button (12) to call the number. "CALLING" and the dialed number are alternately shown on the display.

To call any number,

- press the  button (12).
- Press the On/Off button (3) to open the entry menu and enter a number (enter the phone number as described in the section "Making a call").
- Press the  button (12) to call the number. "CALLING" and the dialed number are alternately shown on the display.

Bluetooth® streaming mode

Starting the Bluetooth® streaming mode

- Press the SRC button (16) repeatedly until "BT STREAM" appears on the display. The playback starts.

Notes:

- The Bluetooth® streaming mode can be selected only if a suitable streaming device is connected.
- If the connection to the streaming device is lost during playback, the display briefly shows "DISCONNECTED" and the car sound system changes to the previous audio source.

Selecting tracks

- Press the </> button (7) briefly to change to the previous/next track.

Interrupting playback

- Press the 3 || (14) button to interrupt the playback ("PAUSE") or to continue it.

Additional functions in the Bluetooth® menu

Changing the Bluetooth® PIN

The factory-set Bluetooth® PIN of the car sound system is "1234"; e.g. it must be entered on the cell phone when pairing a cell phone. This PIN can be changed.

- In the Bluetooth® menu, select the "PIN EDIT" menu item.
- Press the > button (7) to open the entry menu.

You can now enter the PIN:

- Turn the volume control (4) to select a digit for the respective position.
- Press the > or < button (7) to reach the next or previous position.

Note:

While entering the PIN, you cannot change the volume of the car sound system.

- Press the > button (7) repeatedly until you reach past the last position to confirm the PIN entered and return to the Bluetooth® menu.

Managing paired devices

In the Bluetooth® menu, you can manage the paired Bluetooth® devices (cell phones and streaming devices such as MP3 player).

In the device lists for cell phones and streaming devices, the Bluetooth® names or addresses of the paired devices are displayed. You can do the following:

- Disconnecting the connection to the currently connected Bluetooth® device
- Establishing a connection to one of the paired Bluetooth® devices
- Unpairing a Bluetooth® device

➤ In the Bluetooth® menu, select the menu item "PHONE LIST" or "STREAMING LIST".

➤ Press the > button (7) to open the selected list.

The first device on the list is displayed.

Note:

If no device is paired, "NO DEVICE" is briefly displayed.

➤ Press the ▼ / ▲ button (7) once or several times to select another device.

➤ Press the > button (7) to select between the following options:

To connect the selected device,

➤ press the ▼ / ▲ button (7) repeatedly until the "CONNECT DEVICE ..." menu item is selected.

➤ Press the > button (7) to connect the device. As soon as the device is connected, "CONNECTED" is briefly displayed and you are returned to the Bluetooth® menu.

Note:

If no connection can be established, the display briefly shows "CONNECT FAILED". If the device is already connected, the display briefly shows "CONNECTED".

To disconnect the connection to the selected device,

➤ press the ▼ / ▲ button (7) repeatedly until the "DISCONNECT DEVICE ..." menu item is selected.

➤ Press the > button (7) to disconnect the device.

The display briefly shows "DISCONNECTED" and you are returned to the Bluetooth® menu.

To unpair the selected device,

➤ press the ▼ / ▲ button (7) repeatedly until the "DELETE DEVICE ..." menu item is selected.

➤ Press the > button (7) to unpair the device.

The display briefly shows "DELETED" and you are returned to the Bluetooth® menu.

Unpairing all paired devices

➤ In the Bluetooth® menu, select the "DELETE ALL PAIRED DEVICES" menu item.

➤ Press the > button (7) to unpair all cell phones or streaming devices.

The display briefly shows "ALL DEVICES DELETED".

External audio sources

Front AUX-IN socket



Danger!

Increased risk of injury from connector.

In case of an accident, the protruding connector in the front AUX-IN socket may cause injuries. The use of straight plugs or adapters leads to an increased risk of injury.

For this reason, we recommend using angled jack plugs, e.g. the Blaupunkt accessories cable (7 607 001 535).

As soon as an external audio source, such as a portable MP3 player is connected to the front AUX-IN socket (11), it can be selected with the SRC button (16). "AUX" then appears on the display.

Sound settings

The following sound settings can be changed in the "AUDIO" menu:

- Adjusting bass and treble
- Setting the left/right volume distribution (Balance) or front/rear (Fader)
- Adjusting the increase of bass at low volume (X-Bass)
- Selecting a sound profile (Presets)

Calling and exiting the "AUDIO" menu

- Briefly press the **MENU** button (2) to open the user menu.
- Press the **▼ / ▲** button (7) repeatedly until the "AUDIO" menu item is selected.
- Press the **>** button (7) to open the "AUDIO" menu.
- Press the **▼ / ▲** button (7) repeatedly until the desired menu item is selected.
- Perform the setting (see the next section).
- Briefly press the **MENU** button (2) to exit the menu.

Notes:

- The menu is automatically exited approx. 16 seconds after the last button activation and you are returned to the display of the current audio source.
- In the menu, you can press the button **<** (7) in each case to return to the higher menu level.

Making settings in the "AUDIO" menu

BASS

Bass level. Settings: -7 to +7.

- Press the **>** button (7) to open the submenu.
- Turn the volume control (4) to perform the setting.

TREBLE

Treble. Settings: -7 to +7.

- Press the **>** button (7) to open the submenu.
- Turn the volume control (4) to perform the setting.

BALANCE

Left/right volume distribution. Settings: L9 (left) to R9 (right).

- Press the **>** button (7) to open the submenu.
- Turn the volume control (4) to perform the setting.

FADER

Front/rear volume distribution. Settings: R9 (rear) to F9 (front).

- Press the **>** button (7) to open the submenu.
- Turn the volume control (4) to perform the setting.

X-BASS

Increase of bass at low volume. Settings: OFF, 1, 2, 3 (highest increase).

- Press the **>** button (7) to open the submenu.
- Turn the volume control (4) to perform the setting.

PRESETS

Selecting equalizer presettings. Settings: POP, ROCK, CLASSIC, EQ OFF (no presetting).

- Press the **>** button (7) to open the submenu.
- Turn the volume control (4) to perform the setting.

User settings

Calling the user menu and selecting a menu

- Briefly press the **MENU** button (2) to open the user menu.

In the user menu, the user settings can be found in the following menus:

- TUNER
- AUDIO (see chapter "Sound settings")
- DISPLAY
- VOLUME
- CLOCK
- VARIOUS
- BLUETOOTH (Heidelberg 220 BT only, see chapter "Bluetooth®")
- Press the **∇ / ▲** button (7) repeatedly until the desired menu is selected.
- Press the **>** button (7) to open the selected menu.
- Press the **∇ / ▲** button (7) repeatedly until the desired menu item is selected.
- Perform the setting (see the following sections).
- Briefly press the **MENU** button (2) to exit the menu.

Notes:

- The menu is automatically exited approx. 16 seconds after the last button activation and you are returned to the display of the current audio source.
- In the menu, you can press the **<** button (7) in each case to return to the higher menu level.

Making settings in the "TUNER" menu

RDS

Switching the RDS function on or off. Settings: ON, OFF.

- Press the **>** button (7) to open the submenu.
- Turn the volume control (4) to change between the settings.

TRAFFIC (traffic information) (only for reception area EUROPE)

Only possible in FM radio mode: Switching priority for traffic announcements on or off. Settings: ON, OFF.

- Press the **>** button (7) to open the submenu.
- Turn the volume control (4) to change among the settings.

If priority is switched on for traffic information, the display shows the icon .

TUN BAND (band selection)

Activating or deactivating memory banks.

Memory banks that can be deactivated:

Region	Memory banks
EUROPE	FM2, FMT, MW
USA	FM2, FMT, AM, AMT
S-AMERICA	FM2, FMT, AM, AMT
THAILAND	FM2, FMT, AM, AMT

Settings in each case: ON, OFF.

- Press the **>** button (7) to open the submenu.
- Press the **∇ / ▲** button (7) repeatedly until the desired memory bank is displayed.
- Press the **>** button (7) to change the setting.
- Turn the volume control (4) to toggle between the settings ON (activate memory bank) and OFF (deactivate memory bank).

Deactivated memory banks are skipped during the source selection with the **SRC** button (16).

Notes:

- In the factory default, all AM memory banks are deactivated.
- If a memory bank is deactivated, the stations stored in this memory bank are retained.

REGIONAL (only for reception area EUROPE)

Only possible in FM radio mode: Switching REGIONAL function on or off. Settings: ON, OFF.

- Press the > button (7) to open the submenu.
- Turn the volume control (4) to change between the settings.

SEEK SENS

Setting the sensitivity of station seek tuning. Settings: LO1 (lowest) – HI6 (highest).

- Press the > button (7) to open the submenu.
- Turn the volume control (4) to change between the settings.

PTY

Switching the PTY function on or off. Settings: ON, OFF.

- Press the > button (7) to open the submenu.
- Turn the volume control (4) to change between the settings.

PTY LANG (only for reception area EUROPE)

Select the language for the display of the programme types. Settings: ENGLISH, DEUTSCH (German), FRANCAIS (French).

- Press the > button (7) to open the submenu.
- Turn the volume control (4) to select a language.

AREA (reception area)

Select the reception area for the radio reception. Settings: EUROPE, USA, S-AMERICA, THAILAND.

- Press the > button (7) to open the submenu.
- Press the V / ^ button (7) to select a reception area.
- Press the > button (7) to set the reception area.
- Press the > button (7) to confirm the selected reception area.

Making settings in the "DISPLAY" menu

DIM DAY/DIM NIGHT

Setting the display brightness for the day (DIM DAY) or the night (DIM NIGHT). Settings: 1 – 16.

- Press the > button (7) to open the submenu.
- Turn the volume control (4) to perform the setting.

If your car sound system is installed as described in the installation instructions and your vehicle features the corresponding connection, the display brightness for day and night is switched by switching the vehicle lighting on or off.

SCROLL

Select the display of scrolling text (e.g. when displaying MP3 file names) either as single display or continued display. Settings: 1X (single display), ON (continued display).

- Press the > button (7) to open the submenu.
- Turn the volume control (4) to change between the settings.

Making settings in the "VOLUME" menu

ON VOLUME

Setting the power-on volume. Settings: 1 – 50.

- Press the > button (7) to open the submenu.
- Turn the volume control (4) to set the desired power-on volume.

LAST VOL

If you select the setting LAST VOL, every time you switch on the radio, the volume level that was set the last time you switched the radio off is activated again. Settings: ON, OFF.



Danger!

High volume

The power-on volume can be unexpectedly high if the LAST VOL setting is selected and a high volume was set the last time the radio was switched off.

Always set the device to a moderate volume.

- Press the > button (7) to open the submenu.
- Turn the volume control (4) to change between the settings.

TA VOLUME

(only for reception area EUROPE)

Setting the minimum volume for traffic announcements. Settings: 1 – 50.

- Press the > button (7) to open the submenu.
- Turn the volume control (4) to perform the setting.

TEL VOLUME

(for Heidelberg 220 BT only and with connected cell phone)

Adjust hands-free volume. Settings: 1 – 40.

- Press the > button (7) to open the submenu.
- Turn the volume control (4) to perform the setting.

Note:

During the call, you can adjust the volume with the volume control (4).

BEEP

Switching the confirmation beep on or off. Settings: ON, OFF.

- Press the > button (7) to open the submenu.
- Turn the volume control (4) to perform the setting.

Making settings in the "CLOCK" menu

CLK DISP

Switch the permanent display of the time on or off. Settings: ON, OFF.

- Press the > button (7) to open the submenu.
- Turn the volume control (4) to perform the setting.

If the permanent display of the time is switched on, the time is shown on the display. The display of the respective audio source is shown only after pressing a button. Approximately 16 seconds after the button is pressed last, the time is displayed again.

HOURLY MODE

Selecting the 12 or 24-hour time. Settings: 12, 24.

- Press the > button (7) to open the submenu.
- Turn the volume control (4) to perform the setting.

CLOCK SET

Setting the time.

- Press the > button (7) to open the submenu.
- Press the </> button (7) to change between minutes and hours.
The minute or hour display flashes if it is selected.
- Turn the volume control (4) to adjust the minutes or hours.
- Briefly press the **MENU** button (2) to confirm the time entered and to exit the user menu.

Making settings in the "VARIOUS" menu

SCAN TIME

Setting the scan time in 5-second increments. Settings: 5 – 30.

- Press the > button (7) to open the submenu.
- Turn the volume control (4) to perform the setting.

BROWSE

Switching fast track selection in browse mode on or off using the volume control (4). Settings: ON, OFF.

- Press the > button (7) to open the submenu.
- Turn the volume control (4) to perform the setting.

NORMSET

Restoring the original factory settings of the car sound system.

- Press the > button (7) to open the submenu.
- Press the > button (7) to confirm restoring the factory settings.

The car sound system switches off and is reset to the factory settings.

Factory settings

Important factory settings in the user menu:

Menu item	Factory setting
AREA	EUROPE
FM1 / FM2 / FMT	ON
MW*	OFF
AM** / AMT**	OFF
RDS	ON
REGIONAL*	OFF
TRAFFIC*	OFF
SEEK SENS	HI6
PTY	OFF
ON VOLUME	20
TA VOLUME*	20
BEEP	ON
BROWSE	ON
SCAN	10 SEC
SCROLL	1X
HOURLY MODE	24
CLOCK SET	00:00

* Only in reception area "EUROPE"

** Only in reception areas "USA", "S-AMERICA" and "THAILAND"

In the user menu, you can restore the original factory settings of the car sound system (see the chapter "User settings", section "Making settings in the "VARIOUS" menu", menu item "NORMSET").

Useful information

Warranty

We provide a manufacturer's warranty for products bought within the European Union. For devices purchased outside the European Union, the warranty terms issued by our respective responsible domestic agency are valid. The warranty terms can be called up from www.blaupunkt.com.

Service

In some countries, Blaupunkt offers a repair and pick-up service.

Information about the availability of this service in your country can be found at www.blaupunkt.com.

If you want to take advantage of this service, you may request a pick-up service for your car sound system via the Internet.

Technical data

Voltage supply

Operating voltage: 10.8 – 15.6 V

Current consumption

In operation: < 10 A
 10 sec. after switch-off: < 2 mA
 (Heidelberg 220 BT)
 < 4 mA
 (Stuttgart 120)

Amplifier

Output power: 4 x 20 watts sine
 at 14.4 V at 4 ohms
 at 10 % THD.
 4 x 45 watts max. power

Tuner

Wavebands in Europe/Thailand:

FM: 87.5 – 108 MHz

AM (MW): 531 – 1,602 kHz

Wavebands in the US:

FM: 87.7 – 107.9 MHz

AM (MW): 530 – 1,710 kHz

Wavebands in South America:

FM: 87.5 – 107.9 MHz

AM (MW): 530 – 1,710 kHz

FM frequency response: 30 – 15,000 Hz

CD

Frequency range: 20 – 20,000 Hz

Pre-amp out

2 channels: 2 V at THD < 1 %

Input sensitivity

Front AUX-IN: 300 mV / 10 k Ω

Dimensions and weight

W x H x D: 178 x 51 x 158 mm

Weight: 1.475 kg

Subject to changes

Installation instructions



Safety instructions

When carrying out installation work and making connections please observe the following safety instructions:

- Disconnect the negative terminal of the battery! When doing so, please observe the vehicle manufacturer's safety instructions.
- Make sure you do not damage vehicle components when drilling any holes.
- The cross sections of the positive and negative cables must not be less than 1.5 mm².

- **Do not connect the vehicle's plug connectors to the radio!**

You can obtain the adapter cable required for your vehicle type from any BLAUPUNKT dealer.

- Depending on the model, your vehicle may differ from the description provided here. We accept no responsibility for any damages due to incorrect installation or connection or for any consequential damages.

If the information provided here is not suitable for your specific installation requirements, please contact your Blaupunkt dealer, your vehicle manufacturer or our telephone hotline.

When installing an amplifier, you must first connect the device earth connections before connecting the plugs for the line-out jacks.

Earth connection of external devices may not be connected to earth of car sound system (housing).

Supplied mounting hardware

1 011 200 202 / 1 011 200 212:

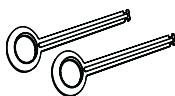
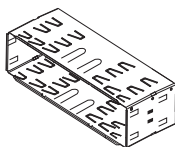

Supplied mounting hardware

1 011 200 203 / 1 011 200 213:

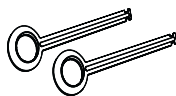
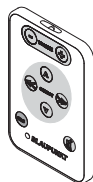
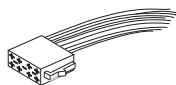
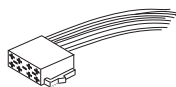
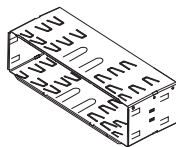

Available as an optional accessory

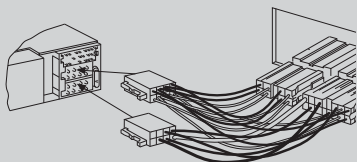

7 607 621 ...

Installation kits

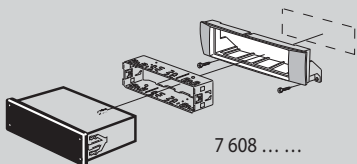

7 608

1.

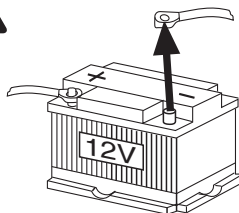

2.

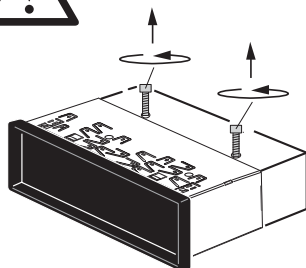

3.

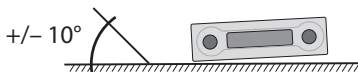
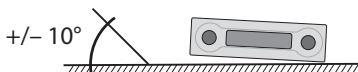
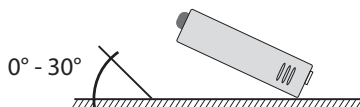

4.

1 011 200 202 / 1 011 200 212:

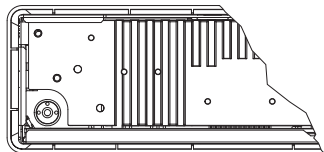

Antenna connection

1 011 200 203 / 1 011 200 213:

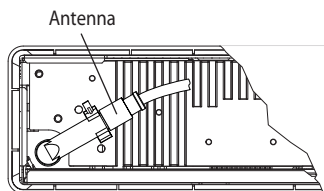

Antenna connection

5.

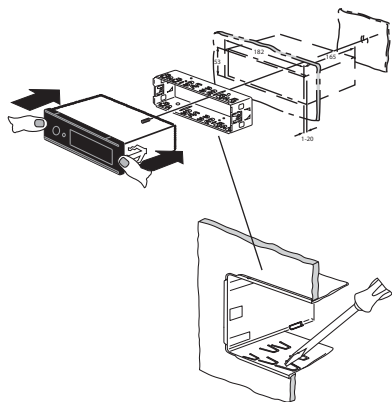

6. Removal

1.

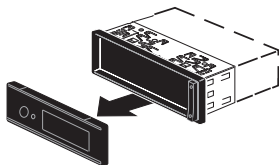

2.

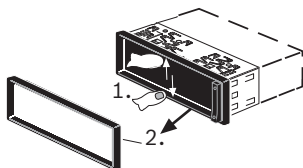

3.

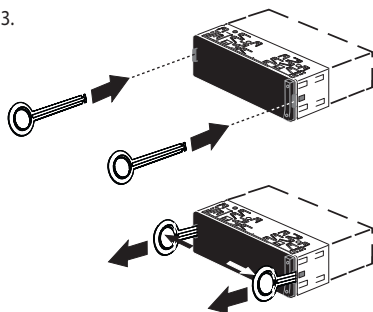

7.

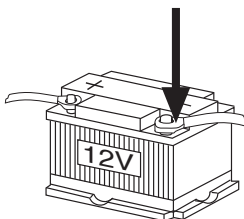

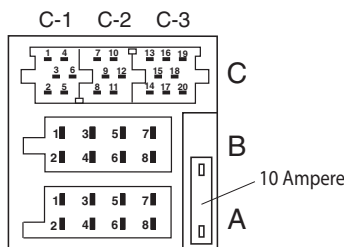

- * Aut. antenna +12V
 Amplifier +12V
 Remote Control +12V
 Switched Ext. Supply +12V
 max. 200 mA

A		B	
1	NC	1	Speaker Out RR+
2	Radio Mute	2	Speaker Out RR-
3	NC	3	Speaker Out RF+
4	Permanent +12V	4	Speaker Out RF-
5	Aut. antenna +12V *	5	Speaker Out LF+
6	Illumination	6	Speaker Out LF-
7	Kl.15/Ignition	7	Speaker Out LR+
8	Ground	8	Speaker Out LR-

C1		C2		C3	
1	NC	7	NC	13	Uart Communication RX
2	NC	8	NC	14	Uart Communication TX
3	Line Out GND	9	Radio Mute	15	Battery Connection Fused **
4	Line Out Left	10	Remote Control +12V *	16	Switched Ext. Supply +12V *
5	Line Out Right	11	Remote Control IN	17	Battery GND
6	Line Out +12V *	12	Remote Control GND	18	NC
				19	NC
				20	NC

** Battery voltage 12V

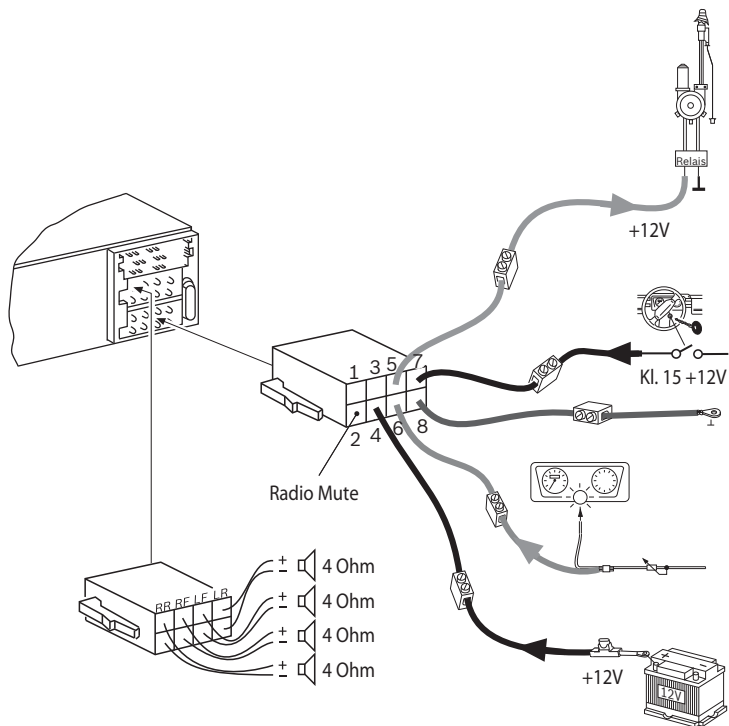

Subject to changes!

Please keep the filled-in radio pass in a safe place!

© 2012 All rights reserved by Blaupunkt. This material may be reproduced, copied or distributed for personal use only.

This product is protected by certain intellectual property rights of Microsoft. Use or distribution of such technology outside of this product is prohibited without a license from Microsoft.

Passport

Name:

Type: **1 011 200** _ _ _

Serial no.: **BP**

 **BLAUPUNKT**

Blaupunkt AudioVision GmbH & Co. KG
Robert-Bosch-Straße 200
D-31139 Hildesheim
<http://www.blaupunkt.com>