

Burner Systems:

G45-GL-16/19(P)
 G45-GL-18(P)
 G45-GL-24(P)
 G45-GL-30(P)
 G45-GL-36(P)
 G45-GL-42(P)
 G45-GL-48(P)
 G45-GL-60(P)



Design Certified

to:
 Z21.84b-2004

(16/19" - 30" models)

**FOR INSTALLATION IN
 SOLID-FUEL BURNING
 FIREPLACES***

**FOR USE WITH
 FYRE GLASS / FYRE GEMS**

G45-GL SERIES VENTED GAS BURNER SYSTEMS (UNREGULATED)

WARNING

If the information in this manual is not followed exactly, a fire or explosion may result, causing property damage, personal injury, or loss of life.

Do not store or use gasoline or other flammable vapors and liquids in the vicinity of this or any other appliance.

WHAT TO DO IF YOU SMELL GAS:

- **Open a window.**
- **Do not try to light any appliance.**
- **Do not touch any electrical switch; do not use any phone in the building.**
- **Immediately call the gas supplier from a neighbor's phone. Follow gas supplier's instructions.**
- **If you cannot reach the gas supplier, call the fire department.**

Installation and service must be performed by a qualified professional installer, service agency, or the gas supplier.

This appliance is only for use with the type of gas indicated on the rating plate.

IMPORTANT: READ THESE INSTRUCTIONS CAREFULLY BEFORE STARTING INSTALLATION OF THE SYSTEM.

The Real-Fyre gas burner system is to be installed only in a solid-fuel burning fireplace with a working flue and constructed of noncombustible material. The installation, including provisions for combustion and ventilation air must conform with the *National Fuel Gas Code, ANSI Z223.1/NFPA 54*, or the *CSA B149.1, Natural Gas and Propane Installation Code*, and applicable local building codes.

A damper clamp is included to maintain the minimum permanent vent opening and to prevent full closure of the damper blade. **The chimney damper MUST be fully opened when burning the burner system. The burner system is designed to burn with yellow flames; thus adequate ventilation is absolutely necessary.**

To comply with certification, listings, and building code acceptances, and for safe operation and proper performance of this burner system, use ONLY Peterson parts and accessories. Use of other controls, parts, and accessories that are not designed for use with Real-Fyre gas burner systems is prohibited and will void all warranties, certifications, listings, and building code approvals, and may cause property damage, personal injury, or loss of life.

***Note:** Solid-fuels shall not be burned in a fireplace where a decorative appliance is installed.



**INSTALLER:
 Leave this manual with the appliance.
CONSUMER:
 Retain this manual for future reference.**



TABLE OF CONTENTS

PARTS LIST	3
IMPORTANT INFORMATION	4
FIREPLACE REQUIREMENTS	4
GLASS/GEMS QUANTITY DETERMINATION	5
INSTALLATION	6
GLASS/GEMS PLACEMENT	8
OPERATING INSTRUCTIONS	9
CLEANING AND MAINTENANCE	10
MAINTENANCE	10
CLEANING	10
SERVICE	10
FLAME DESCRIPTION	10
PILOT BURNER ADJUSTMENT (IF EQUIPPED)	11
OPTIONAL CONTROLS FOR YOUR REAL-FYRE® BURNER SYSTEM	12
OPTIONAL PETERSON VALVES & SAFETY PILOT KITS	13
TROUBLESHOOTING	14
WARRANTY	16

Tools Recommended

The following tools and supplies may be needed to assemble, install, and test the Real-Fyre® gas burner system:

1. Adjustable open-ended wrench 8" - 10"
2. Pipe wrench 8" - 10"
3. Pliers
4. Teflon tape or pipe compound resistant to propane gas
5. Small Phillips-head screwdriver & flat-head screwdriver
6. Leak detector or soapy water solution & brush to test for gas leaks
7. Work gloves

Other tools used for plumbing or gas appliance installation may be necessary.

WARNING

Improper installation, adjustment, alteration, service, or maintenance can cause injury or property damage. Refer to this manual. For assistance or additional information, consult a qualified installer, service agency, or the gas supplier.

FOR YOUR SAFETY

Do not store or use gasoline or other flammable vapors and liquids in the vicinity of this or any other appliance.

PARTS LIST

Before installation, check that your gas burner system is complete. See the parts list below. If any parts are missing or damaged, contact your Real-Fyre® dealer. Be sure you know the model and size of your set when ordering options or replacement parts and accessories.

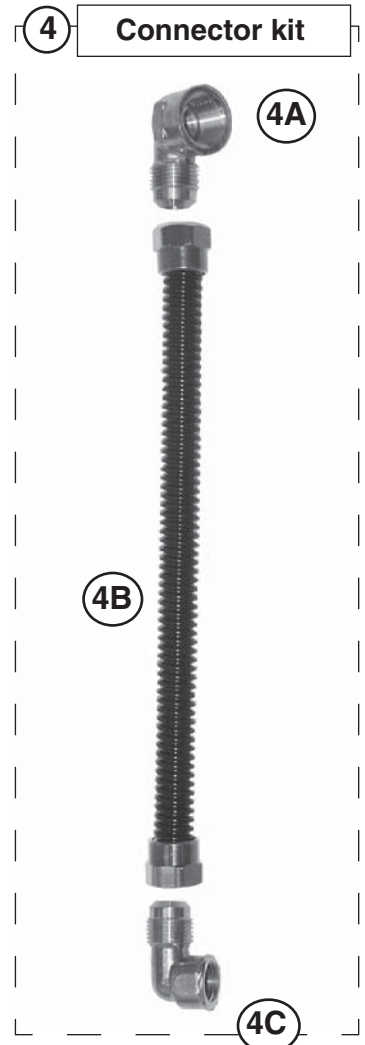
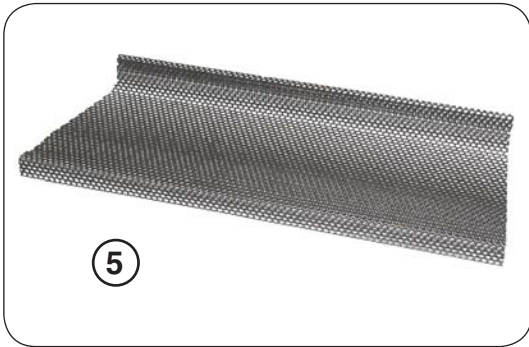

Item No.	Description	Qty.
1.	Burner pan	1
2.	Fuel injector/air mixer	1
3.	Damper clamp with bolt	1
4.	Connector kit (with adapters)	1
5.	Separator screen	1
6.	Select sand granules (nat. only) or vermiculite granules (propane only)	1

Glass / gems are purchased and packaged separately. Quantity will vary, depending on selection. Glass and gems are available in various colors; contact your dealer for further details.

Note: All drawings & photos in this manual are not to scale.

Actual parts may differ

Replacement parts can be ordered from your local Real-Fyre® dealer.

IMPORTANT INFORMATION

Important: To comply with certification, listings, and building code acceptances, and for safe operation and proper performance of this burner system, use ONLY Peterson Real-Fyre® parts and accessories. Use of other controls, parts, and accessories that are not designed for use with Real-Fyre® gas burner systems is prohibited and will void all warranties, certifications, listings, and building code approvals, and may cause property damage, personal injury, or

Check to be sure the fireplace meets venting and construction requirements for the installation of the Real-Fyre® gas burner system (see FIREPLACE REQUIREMENTS section, below).

Be sure your gas burner system is properly sized for your fireplace. Improper sizing may negatively impact the proper drafting of the fireplace. Additionally, too large a burner system will adversely affect the burn and hamper the proper operation of the control system. Too small a burner system will diminish the beauty of your hearth setting.

FIREPLACE REQUIREMENTS

This Real-Fyre® gas burner system is to be installed only in a fully vented, noncombustible fireplace with an open damper. The chimney must be free of any obstructions. The fireplace must be designed and approved to burn wood. Your Real-Fyre® burner system is designed to burn with yellow, smoky flames. For this reason, it must be adequately vented.

The fireplace must have a gas-supply line that has been installed by a qualified technician in accordance with all local codes. The gas-supply line must be ½" minimum interior diameter. If the gas line to the fireplace is longer than 20', a larger-diameter line may be necessary.

A fireplace screen must be in place when the system is burning. Provisions for adequate combustion air must be maintained. Unless other provisions for combustion air are provided, the screen shall have an opening(s) for introduction of combustion air. Combustion air is adequate when all flames curl into the fireplace and away from the screen. **When a glass fireplace enclosure (door) is used, leave the doors fully open when the system is in operation.**

Required Gas Pressure: The minimum inlet gas-supply pressure for the purpose of input adjustment is 7" of water column (w.c.) for natural gas and 11" w.c. for propane. The maximum inlet gas-supply pressure is 10.5" w.c. for natural gas and 13" for propane.

Fig. 4-1 **Fireplace Dimensions**

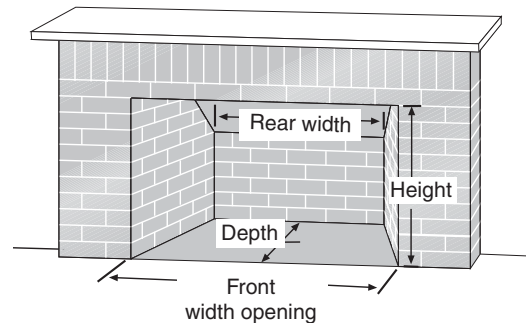

Note: It is recommended that complete firebox dimensions (front width, back wall, and height) be obtained to ensure proper sizing.

Burner size	Min. Fireplace Dimensions				BTU	
	Width		Depth	Height	NAT.	L.P.
	Front*	Rear				
16/19"	22"	20"	12"	18"	35k	28k
18"	24"	22"	12"	18"	55k	38k
24"	30"	28"	12"	18"	75k	50k
30"	36"	34"	12"	18"	75k	60k
[36"]	42"	40"	12"	18"	100k	70k
[42"]	48"	46"	12"	18"	105k	85k
[48"]	54"	52"	12"	18"	110k	80k
[60"]	66"	64"	12"	18"	120k	105k

* This required width allows for centering of the burner system. Add 4" to front width if the burner is to be installed with a pilot kit.

Note: Rear width is at corresponding depth. **Bracketed sizes indicate non-certified burner systems.**

Minimum Free Opening Area of Chimney Damper for Venting (sq. in.)								
For Factory-Built Fireplaces *								
Chimney Height	16/19"	18"	24"	30"	36"	42"	48"	60"
15' (min.)	22	38	47	47	63	66	69	75
20'	20	34	42	42	56	59	62	68
30'	18	30	38	38	50	53	55	60

* For Masonry-Built Fireplaces; add 4 sq. in. to amount shown.

GLASS/GEMS QUANTITY DETERMINATION

CAUTION: Sand granules are for use with natural gas systems only. Always use vermiculite granules for propane gas systems.

The granules that come with the burner system are pre-measured and must be used per these instructions (see GLASS/GEMS PLACEMENT section).

Decorative glass/gems (purchased separately) must be placed to cover the burner (but not on the valve or pilot, if equipped). See Table 5-1 for the minimum bag requirement depending on your burner size. Additional glass/gems may be purchased and placed around the burner if desired.

Should you wish to fill the entire fireplace floor with glass/gems; instead use Table 5-2 to determine how many bags of glass/gems to order **based on fireplace size**.

One 10-lb. bag of glass/gems fills approximately 144 cubic inches.

CAUTION: When covering the burner with glass/gems; do not exceed 1" above the top of the burner. Additional glass/gems directly on top of the burner may result in unsafe ignition.

Minimum burner coverage requirement Table 5-1	Burner size							
	16/19	18	24	30	36	42	48	60
Glass/gem 10 lb. bag(s) needed	1	1	1	1	2	2	2	3

- OR -

Fireplace complete coverage Table 5-2	Fireplace				Glass/gems 10 lb. bags needed for 2" depth
	Opening size	Center width (in.)	Front to back depth (in.)	Area (sq. in.)	
Standard Fireplace Sizes	28"	25	16	400	6
				540	8
	36"	30	23	690	10
	32" see-thru	31	23	713	10
	42"	36	30	828	12
				1085	15
	50"	46	33	1334	19

These bag quantities listed allow for an approximate 2" depth of glass in the entire fireplace floor, without a burner. (The volume of the burner will take up some space, allowing for some excess glass to be used as desired, or stored as extra for later use.)

Your fireplace area can be determined by measuring the center width of your fireplace in inches and multiplying by the depth from front to back in inches. You can then use the area column in the table above to approximate the number of bags needed.

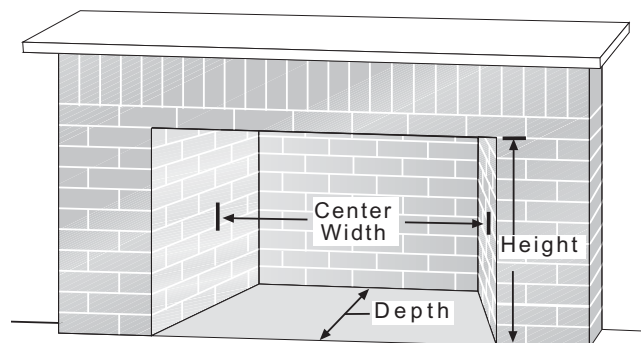

INSTALLATION

The damper clamp with hex bolt (Fig. 6-1) is provided as a means to prevent full closure of the damper blade. The clamp is easily attached to most damper blades with pliers or a wrench, and must be permanently installed. The clamp is designed to prevent accidental closure of the damper when installed as illustrated (Fig. 6-2 and Fig. 6-3). Should the clamp not fit, or fail to provide the permanent vent opening listed in the table found above, have a permanent stop installed, remove the damper blade, or have the damper cut to provide the minimum permanent opening required.

Note: These are minimum damper opening specifications. The damper must be completely opened when operating this gas appliance to achieve the best ventilation possible.

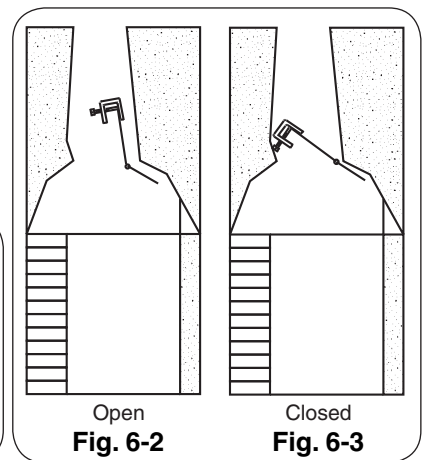
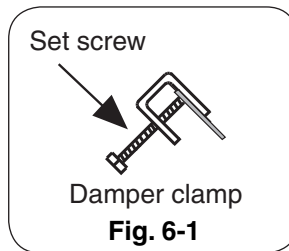

INSTALLING THE BURNER

The Real-Fyre gas burner system must be installed by a qualified professional service technician. Instructions must be followed carefully to ensure proper performance and full benefit from the gas burner system. **Check to be sure the burner system is designed and labeled for the type of gas (natural or propane gas) supplied to the fireplace. Fireplace floor must be level, clean, and smooth.**

WARNING: Failure to position the parts in accordance with these diagrams or failure to use only parts specifically approved with this appliance may result in property damage or personal injury.

REFER TO THE PARTS LIST WHEN FOLLOWING THESE INSTRUCTIONS. If your burner is to be installed with a pilot kit; carefully follow the instructions supplied with your pilot kit for specific gas connection.

The burner pan is supplied with an air mixer for propane gas or a fuel injector for natural gas. **The air mixer / fuel injector must be used in ALL installations.** The air mixer / fuel injector has a precisely sized orifice to ensure only the proper quantity of gas enters the burner. This allows maximum performance and gas conservation.

1. MAKE SURE THE FIREPLACE GAS SUPPLY IS TURNED OFF.
2. Locate the gas-supply stub inside the fireplace and remove the cap, if attached (see Fig. 6-4).

CAUTION: When removing the cap, make sure the stub does not turn, loosening the connection inside the wall.

3. Attach the small adapter (Item 4C) to the fuel injector / air mixer on the burner pan, using a pipe compound resistant to all gases. Tighten securely. **DO NOT REMOVE THE FUEL INJECTOR / AIR MIXER.** Then attach one end of the flex connector (Item 4B) to the small adapter. Tighten securely.
4. Place the burner system into the fireplace so that it is centered and the open burner pan faces outward.

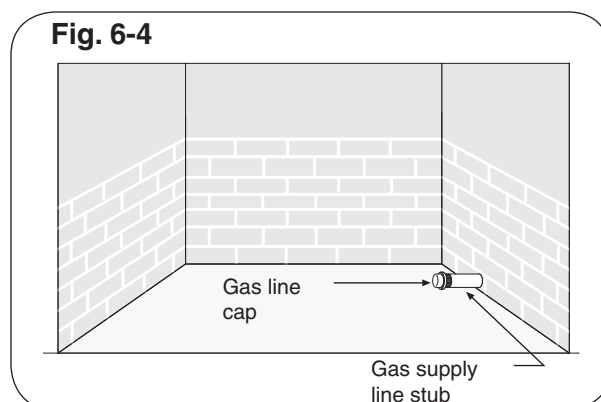

INSTALLATION (cont.)

- 5. Be sure gas to the fireplace is off.** Attach the large adapter (Item 4A) to the gas-supply stub using a pipe compound resistant to all gases. Tighten securely. Then attach the open end of the flex connector to the large adapter. Tighten securely. Ensure the pan rests level on the fireplace floor after connection. Adjust the pan if necessary.
- 6. LEAK TEST:** Use a long-necked butane lighter, or lay a lighted match next to the burner pipe, and carefully turn on the gas supply until the burner ignites. Test at all connections for leaks using the appropriate soapy water solution. If bubbles appear, a leak is present. Turn off the gas and tighten at all connections. Repeat until no leaks are present. If a leak persists, turn off the gas supply and contact the local gas company or dealer. **NEVER USE A FLAME TO CHECK FOR LEAKS.**

Turn off the gas supply prior to proceeding.

Fig. 7-1 - Fireplace valve

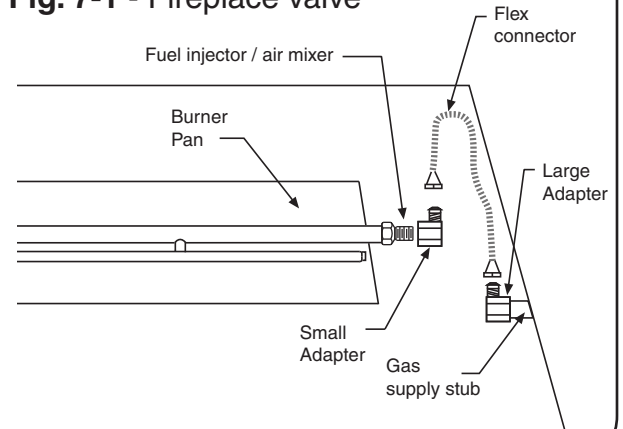

GLASS / GEMS PLACEMENT

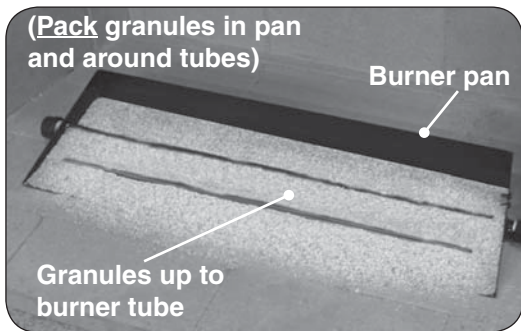

Fig. 8-1

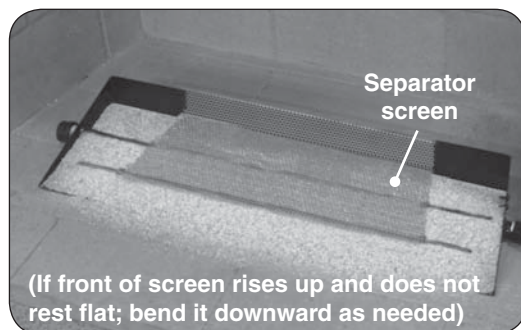

Fig. 8-2

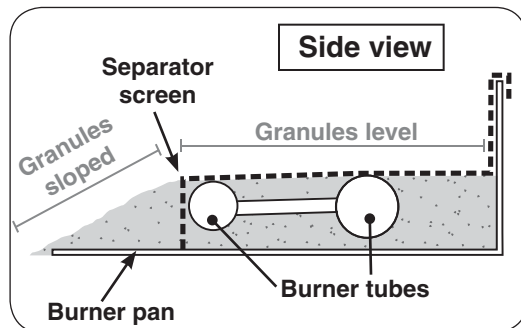

Fig. 8-3

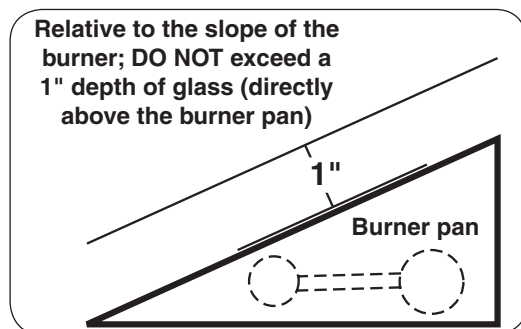

Fig. 8-4

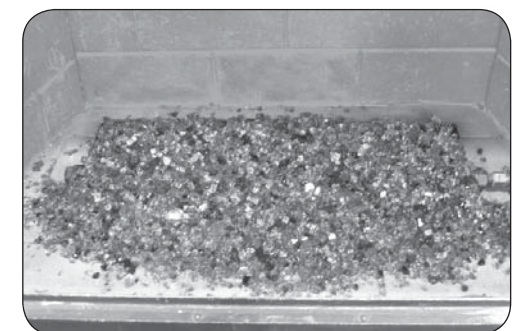

Fig. 8-5

BURNER PREPARATION

After hooking up the burner to the fireplace gas supply and placing the heat shield on the valve assembly (if applicable), the decorative media (granules and glass / gems) must be added for the burner to function as designed.

Note: Installation is the same for glass and gems. Glass shown here. These instructions show sand granules being used as a base for the glass, but only natural-gas burners use sand. For propane burners, follow these instructions using vermiculite.

WARNING

The burner and pilot (if equipped) must be **OFF** (fully extinguished), and all valve covers must be in place before pouring media onto the burner. It may also be necessary to temporarily cover the pilot assembly (if equipped) to keep media out of it during this procedure.

GRANULE PLACEMENT

1. Pour the granules into the pan until they just cover the burner tubes. Then pack the granules in the pan and around the burner tubes. Add additional granules as needed to end with the granules **level** with the top of the burner tubes. Slope the granules in the front portion of the pan. See Fig. 8-1 and Fig. 8-3.
2. Place the separator screen over the granules such that the rear of the screen hooks over the top and back of the burner pan, as shown in Fig. 8-2 and Fig. 8-3. If the front of the screen rises up from the floor of the pan, bend it downward as needed.

Note: The screen must correctly rest onto the burner pan. If it sits too high; remove some of the granules to ensure a proper fit. **DO NOT** allow for any granules to be above the screen.

GLASS / GEMS PLACEMENT

CAUTION: Glass pieces may have sharp edges. Be careful handling the glass. Use hand protection, such as gloves, if necessary.

1. Pour the glass / gems directly on top of the granules and screen so that the burner pan is covered completely and evenly. Relative to the slope of the burner; DO NOT exceed a 1" depth of glass (directly above the burner pan) as shown in Fig. 8-4.

Note: At this stage the burner will function as designed; however, more glass / gems may be added around the burner for decorative purposes. If glass / gems are desired behind the burner pan, they may be left at a lower level than the back of the pan, as shown in Fig. 8-6, or raised up to or above the level in the back of the pan.

2. Add additional glass / gems around the burner pan as desired (Fig. 8-6).

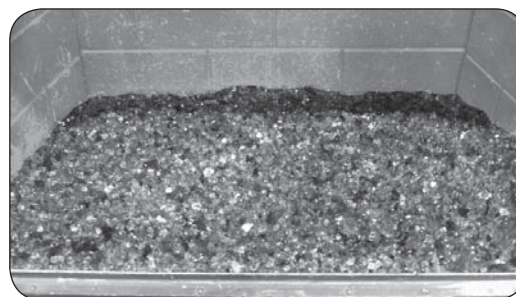

Fig. 8-6

OPERATING INSTRUCTIONS

Before operating your gas log set:

1. Be sure your fireplace is free from flammable liquids or combustible materials.
2. Be sure your damper is open.
3. Smell all around the gas log set for the odor of escaping gas. **IF YOU SMELL GAS, FOLLOW THE INSTRUCTIONS ON P. 1.**

If your gas log set is operated by the fireplace valve:

1. Lay a lighted long-stem match on the surface of the embers near the gas inlet (**do not hold the match in your hand**) or use a lighted long-necked butane lighter (Fig. 9-1).
2. Slowly turn the fireplace remote valve to the **ON** position. Your log set should light.
3. If the log set does not light before the match goes out, immediately turn the valve to the **OFF** position.
4. Wait approximately five (5) minutes to clear out any gas, and repeat steps 1-3 above.
5. If your log set fails to light again, turn the valve to the **OFF** position and contact your dealer or gas supplier.
6. **To extinguish your gas log set**, turn the valve to the **OFF** position. Be sure the valve is turned fully off to avoid any gas leakage.

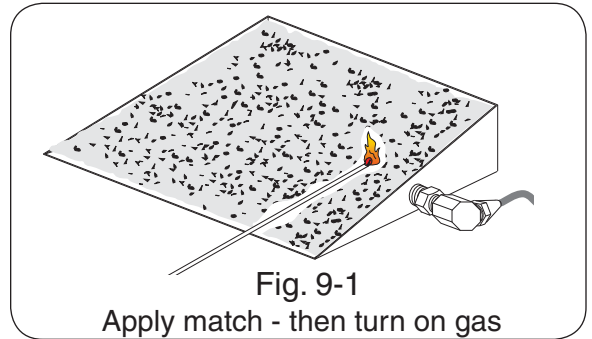

If your burner is operated by a pilot kit:

1. Carefully follow the lighting instructions supplied with your pilot kit for the steps to ignite the burner.

MAINTENANCE

Once installed and operating properly, your Real-Fyre® glass burner will require regular maintenance. You should inspect your glass burner and controls (where installed) for the following:

1. Moisture may cause the glass in your burner pan to settle. To improve the burn, follow these tips:
 - a. Settling of glass - Using a screwdriver or flat-blade knife, carefully stir the glass, loosening the material. Clear up any spills.
2. Debris around the control (if equipped)
-Inspect control and pilot to be sure they are free of dirt or debris.
3. **Insects and burner blockage** - Check the burner ports and air shutter, if present, to make sure they are free from debris. Blocked burner ports and orifices may result in a fire at the air shutter.

CLEANING

The pilot assembly (if equipped) must be kept clean and clear of debris at all times for the fireplace burner system to be safely and effectively operated. Dust, carpet fibers, paper, spider webs, pet hair, etc. in the fireplace or on the burner assembly can affect operation of burner and pilot assembly. Vacuum or use compressed air from a can or compressor to clean out pilot assembly area, air shutter holes, burner orifices, and pilot air intake openings. Blockage in this area will affect the operation of pilot assembly.

FLAME DESCRIPTION

Observe the flames. The flames should be blue at the base and a combination of blue/yellow at the body and tips. The flames should be 16" to 18" tall. (See Figure 10-1). Inspect the flames periodically. If flames appear different, contact a professional service technician or your gas supplier to correct the problem.

SERVICE

While some minor service conditions can be handled by the owner of the glass burner, a qualified professional service technician should be called to maintain and service your glass burner and any installed control systems. In addition, a periodic examination and cleaning of the solid-fuel-burning fireplace venting system should be conducted by a qualified professional service technician. The TROUBLESHOOTING section of these instructions serves as a guide for ensuring optimum performance of your glass burner.

To protect your investment in your Real-Fyre® gas fireplace burner system and keep it operating safely for years to come, maintain, clean, and inspect it regularly. We recommend following these instructions at the beginning of each fireplace season and as needed throughout the year, depending on your usage pattern and the environmental conditions in your home. More frequent cleaning and maintenance may be necessary when burning propane gas than with natural gas.

- Replace all batteries for remote transmitters and receivers if installed.
- Check and readjust the burner air shutter.
- Clean and test the ignitor and pilot (if equipped).



Figure 10-1

PILOT BURNER ADJUSTMENT (IF EQUIPPED)

The pilot burner is preset at the factory and should normally not require any adjustment. However, should adjustment be necessary, the following steps should be taken:

With the pilot burner lit and the control knob in the pilot position, remove the heatshield covers. Adjust the screw located on the control valve (see Fig. 11-1). Using a screwdriver, turn the pilot adjustment screw slowly clockwise to reduce the flame, or counterclockwise to increase the flame.

The adjustment screw can be turned so that the pilot flame is completely extinguished. The pilot flame should be a quiet soft blue flame with yellow tipping that encircles the thermocouple tip.

Replace the heatshield covers. Turn the control knob to the **ON** position to assure proper ignition of the burner system.

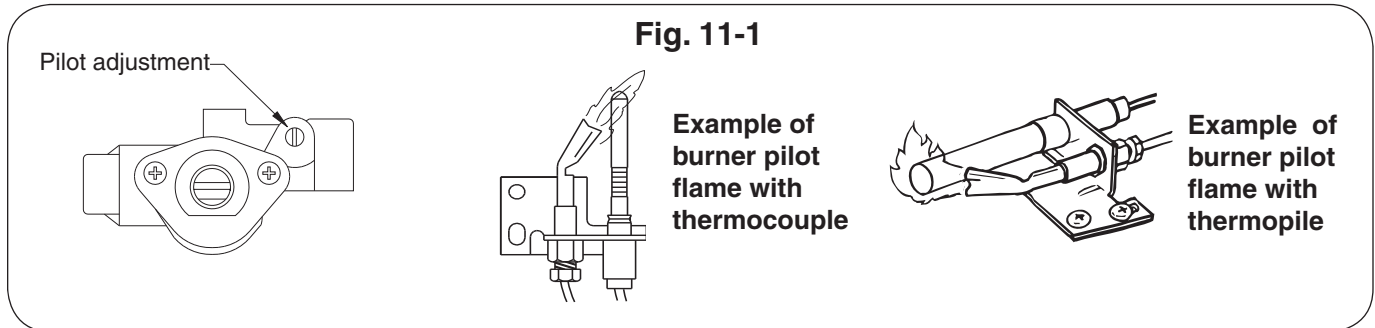

OPTIONAL CONTROLS FOR YOUR REAL-FYRE® BURNER SYSTEM

This unit may come without a valve installed.

It may be connected directly to and operated by your fireplace valve.

Alternatively, your Real-Fyre® burner may be operated using a number of optional Peterson control systems (listed below). Peterson control systems are engineered to provide convenient, safe, and reliable operation of your gas burner system.

For safe operation, proper performance, and to comply with safety standards and certifications, use only Robert H. Peterson Company control systems, parts, and accessories with your Real-Fyre® burner system.

If you have purchased a valve separately, follow the installation instructions that come with your control system.

Peterson Control System and Combinations

Primary Control Method	Order #	
Manual On/Off Systems		
Manual on/off knob (match lit, no pilot)	AV-17	
Manual on/off rod handle (match lit, no pilot)	AV-18	
Manual Safety Pilot Systems*		
Safety pilot w/knob	SPK-20	
Safety pilot w/rod handle	SPK-21	
Low-profile valve	SPK-26	
Piezo spark pilot ignition	SPK-32	
Piezo intermittent ignition pilot	SPK-33	
Remote Safety Pilot Systems*		
Toggle switch	N/A	And also requires one of: APK-11(M)(P) or APK-10(M)(P) or EPK-01
Wall switch	WS-1	
Wall timer	WS-2	
Wood chip switch	WCS-1	
RUS remote	RUS-1	
Remote	RR-1	
Deluxe remote	RR-2	
Pine cone remote receiver	PC-105	
RVF remote	RVF-1	
Wall switch (variable w/switch)	WS-3	
Variable flame-height remote	VR-1A	APK-15(P) or APK-17(P)
Deluxe variable flame-height remote	VR-2A	

*When systems are to be used with propane gas, add a "P" to the control model no. (e.g., APK11MP). Propane burner sets require a safety pilot system. Not all safety pilot systems are available for all burner set sizes.

***M" stands for remote-capable systems. (Remote not included.)

OPTIONAL PETERSON VALVES & SAFETY PILOT KITS

Note: For all valves and safety pilot kits shown on this page, carefully follow the instructions supplied with your safety pilot kit for steps to assemble and install it on the burner pan and test for leaks.

***Available from your local Real-Fyre® dealer**

APK-11

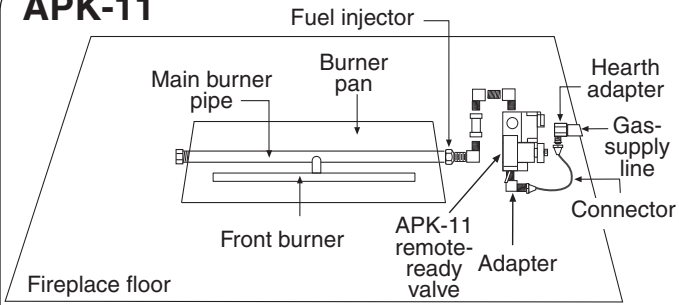

APK-11 Valve

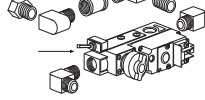
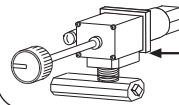
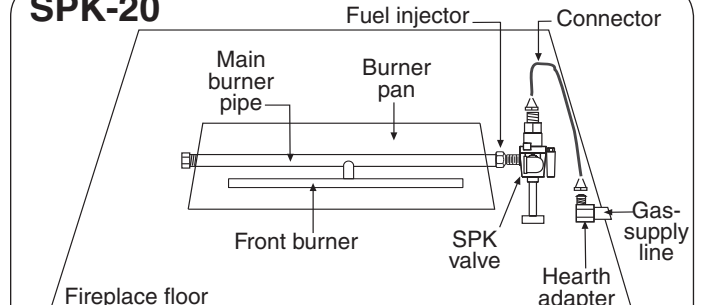

Fig. 13-1

Note: Heat shield is not shown, but must be in place when operating your glass burner.

SPK-20



SPK-20

Fig. 13-4

Note: Heat shield is not shown, but must be in place when operating your glass burner.

APK-15GL

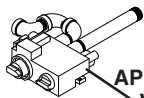
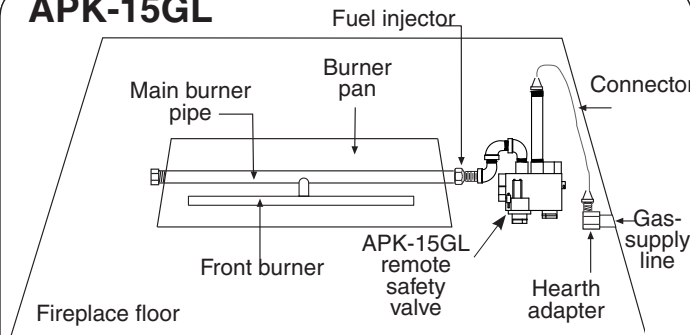

APK-15GL Valve

Fig. 13-2

Note: Heat shield is not shown, but must be in place when operating your glass burner.

SPK-26

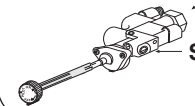
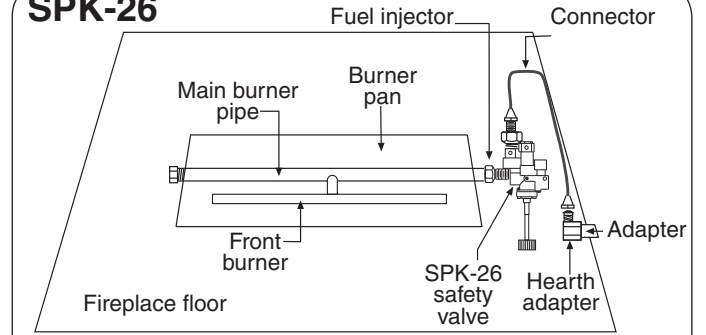

SPK-26 Valve

Fig. 13-5

Note: Heat shield is not shown, but must be in place when operating your glass burner.

APK-17

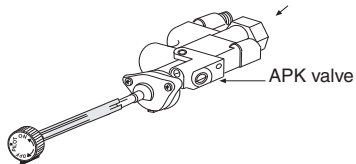
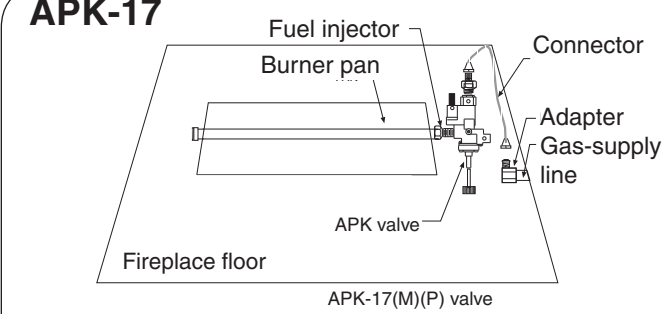

Fig. 13-3

Note: Heat shield is not shown, but must be in place when operating your glass burner.

AV-17 AV-18

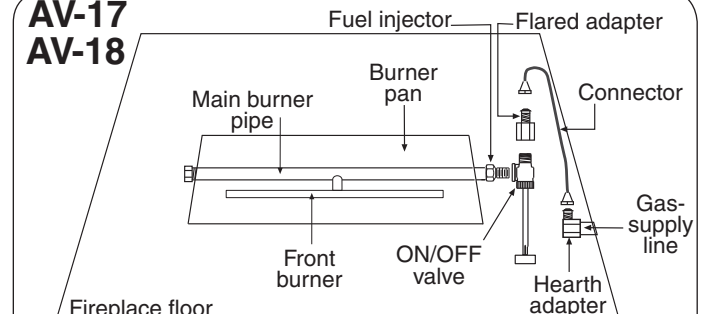

Fig. 13-7

TROUBLESHOOTING

SYMPTOM	CAUSE	SOLUTION
<p>1. Smoking and/or sooting</p> <p>(IMMEDIATELY STOP USING. Call your gas supplier or another qualified professional installer or service agency.)</p>	A. Poor draft or downdraft	A. Check for chimney blockage. Be sure chimney is at least 3' taller than anything within 10' of it in all directions. If not, consult a chimney sweep. Chimney cap or fan may help. Under severe conditions, you may need to open a window near the fireplace about 1" to 2" when burning the unit.
	B. Improper burner for gas used	B. Use only a natural-gas set with natural gas or use only a propane-gas set with propane gas.
	C. Damper closed	C. Open damper fully when operating burner system.
	D. Burner is positioned too close to the front of the firebox	D. Move burner system to the center of the firebox.
	E. Improper glass/gems placement or amount	E. See PLACEMENT OF GLASS/ GEMS section.
	F. Flue is less than 8" in diameter	F. Inadequate fireplace ventilation; consult with a fireplace expert.
	G. Air mixer on propane set is closed	G. Open air mixer completely.
<p>2. Low flame</p>	A. Incorrect decorative media for type of gas used	A. Consult your dealer for proper set.
	B. Insufficient gas supply	B. Other gas appliances may be competing for gas supply. Consult installer or plumber. Orifice size is based upon 7" w.c. pressure for natural gas and 11" w.c. pressure for propane gas. Plumbing must supply adequate pressure.
	C. Blockage or kink in connector kit, plumbing, or burner orifice	C. Clean out blockage. If connector kit is kinked, replace it.
	D. Valve not fully open	D. Open valve fully.

TROUBLESHOOTING (cont.)

SYMPTOM	CAUSE	SOLUTION
3. Uneven flame distribution (Lower at one end of the burner)	A. Clogged or blocked portholes	A. Burner ports can be cleared of foreign objects by running a wire through them.
	B. Insufficient gas pressure and/or supply	B. Consult installer or plumber (see solution 2B).
	C. Decorative media may be packed down too tightly	C. Loosen media around burner pipe by running a kitchen knife along both sides of the pipe. Even out media in burner pan.
	D. Auxiliary shutoff valve partially closed	D. Open valve fully. Usually you will find this along the wall 3' from the fireplace.
4. Flame at air mixer (For propane units)	A. Clogged or blocked burner ports	A. Burner ports can be cleared of foreign objects by running a wire through them.
	B. Insufficient gas pressure and/or supply	B. Consult installer or plumber (see solution 2b).
	C. Decorative media may be packed down too tightly	C. Loosen media around the burner by running a kitchen knife along both sides of the pipe. Be sure granules are used with an air mixer.
	D. Excessive gas pressure	D. Contact your gas supplier.

WARRANTY

PETERSON VENTED DECORATIVE GAS APPLIANCE LIMITED WARRANTY

All Peterson burner assemblies are **WARRANTED for TEN (10) YEARS.**

All Peterson glass is **WARRANTED for TEN (10) YEARS.**

SPK-26 controls are covered by a **THREE (3) YEAR "All Parts" Warranty.**

All other Peterson valves, pilots, and controls are covered by a **ONE (1) YEAR Limited Warranty (excluding batteries).**

PLEASE KEEP A COPY OF YOUR SALES SLIP FOR PROOF OF PURCHASE

This warranty applies to the original purchaser and to single family residential use only. It commences from date of purchase, and is valid only with proof of purchase.

This warranty does not cover parts becoming defective through misuse, accidental damage, electrical damage, improper handling, storage, and/or installation. Product must be installed (and gas must be connected) as specified in the instructions or operator's manual, by a **qualified professional installer**. Accessories, parts, valves, remotes, etc., when used must be Peterson Co. product.

This warranty **does not** apply to rust, corrosion, oxidation, or discoloration, unless the affected component becomes inoperable. It **does not** cover labor or labor-related charges.

This warranty specifically excludes liability for **indirect, incidental**, or consequential damages. Some states do not allow the exclusion or limitation of incidental or consequential damages, so the above exclusion may not apply to you. This warranty gives you specified legal rights, and you may have other rights that may vary from state to state.

For additional information regarding this warranty, or to place a warranty claim, contact the R.H. Peterson dealer where the product was purchased.

**TO REGISTER YOUR PRODUCT ONLINE GO TO: WWW.RHPETERSON.COM,
AND CLICK ON PRODUCT REGISTRATION. THANK YOU FOR YOUR PURCHASE.**