



KPH/KVS/KVH Series

KVM Rear Kit for LCD Console Drawer

User Manual

KPH/KVS/KVH Series: USB Hub KVM Switch 8/16 port with
1/2 user console



14628 Central Ave,
Chino, CA 91710
tel:909.597.7588, fax:909.597.1939

© Copyright 2013 Acnodes, Inc.
All rights reserved. Product description and product specifications
are subject to change without notice. For latest product
information, please visit Acnodes' web site at www.acnodes.com.

Legal Information

First English printing, October 2002

Information in this document has been carefully checked for accuracy; however, no guarantee is given to the correctness of the contents. The information in this document is subject to change without notice. We are not liable for any injury or loss that results from the use of this equipment.

Safety Instructions

Please read all of these instructions carefully before you use the device. Save this manual for future reference.

- Unplug equipment before cleaning. Don't use liquid or spray detergent; use a moist cloth.
- Keep equipment away from excessive humidity and heat. Preferably, keep it in an air-conditioned environment with temperatures not exceeding 40° Celsius (104° Fahrenheit).
- When installing, place the equipment on a sturdy, level surface to prevent it from accidentally falling and causing damage to other equipment or injury to persons nearby.
- When the equipment is in an open position, do not cover, block or in any way obstruct the gap between it and the power supply. Proper air convection is necessary to keep it from overheating.
- Arrange the equipment's power cord in such a way that others won't trip or fall over it.
- If you are using a power cord that didn't ship with the equipment, ensure that it is rated for the voltage and current labeled on the equipment's electrical ratings label. The voltage rating on the cord should be higher than the one listed on the equipment's ratings label.
- Observe all precautions and warnings attached to the equipment.
- If you don't intend on using the equipment for a long time, disconnect it from the power outlet to prevent being damaged by transient over-voltage.
- Keep all liquids away from the equipment to minimize the risk of accidental spillage. Liquid spilled on to the power supply or on other hardware may cause damage, fire or electrical shock.
- Only qualified service personnel should open the chassis. Opening it yourself could damage the equipment and invalidate its warranty.
- If any part of the equipment becomes damaged or stops functioning, have it checked by qualified service personnel.

What the warranty does not cover

- Any product, on which the serial number has been defaced, modified or removed.
- Damage, deterioration or malfunction resulting from:
 - Accident, misuse, neglect, fire, water, lightning, or other acts of nature, unauthorized product modification, or failure to follow instructions supplied with the product.
 - Repair or attempted repair by anyone not authorized by us.
 - Any damage of the product due to shipment.
 - Removal or installation of the product.
 - Causes external to the product, such as electric power fluctuation or failure.
 - Use of supplies or parts not meeting our specifications.
 - Normal wear and tear.
 - Any other causes which does not relate to a product defect.
- Removal, installation, and set-up service charges.

Regulatory Notices Federal Communications Commission (FCC)

This equipment has been tested and found to comply with the limits for a Class B digital device, pursuant to Part 15 of the FCC rules. These limits are designed to provide reasonable protection against harmful interference in a residential installation.

Any changes or modifications made to this equipment may void the user's authority to operate this equipment. This equipment generates, uses, and can radiate radio frequency energy and, if not installed and used in accordance with the instructions, may cause harmful interference to radio communications.

However, there is no guarantee that interference will not occur in a particular installation. If this equipment does cause harmful interference to radio or television reception, which can be determined by turning the equipment off and on, the user is encouraged to try to correct the interference by one or more of the following measures:

- Re-position or relocate the receiving antenna.
- Increase the separation between the equipment and receiver.
- Connect the equipment into an outlet on a circuit different from that to which the receiver is connected.

Contents

< Part 1 > USB Hub DB-15 2-console KVM

KPH802	KPH1602
--------	---------

- | | | |
|-----|-------------------------------------|---------|
| 1.1 | Package contents | P.1 |
| 1.2 | KVM port connection | P.1 |
| 1.3 | IP console connection | P.2 |
| 1.4 | IP console setting | P.2 - 3 |
| 1.5 | Built-in USB hub usage & connection | P.4 |
| 1.6 | Specifications | P.5 |

< Part 2 > USB Hub DB-15 2-console KVM

KVS802	KVS1602
--------	---------

- | | | |
|-----|-------------------------------------|---------|
| 2.1 | Package contents | P.6 |
| 2.2 | KVM port connection | P.7 |
| 2.3 | Remote console connection | P.7 - 8 |
| 2.4 | Built-in USB hub usage & connection | P.9 |
| 2.5 | Specifications | P.10 |

< Part 3 > USB Hub DB-15 KVM

KVH801	KVH1601
--------	---------

- | | | |
|-----|-------------------------------------|------|
| 3.1 | Package contents | P.11 |
| 3.2 | KVM port connection | P.12 |
| 3.3 | Built-in USB hub usage & connection | P.13 |
| 3.4 | Specifications | P.14 |

< Part 4 > Usage

- | | | |
|-----|------------------------------------|------|
| 4.1 | KVM Button | P.15 |
| 4.2 | Password | P.16 |
| 4.3 | KVM OSD | P.17 |
| 4.4 | KVM Hotkey & Remote Console Hotkey | P.18 |
| 4.5 | DC power 12V, 24V, 48V Input | P.19 |

KPH802
KPH1602

KVM Rear Kit

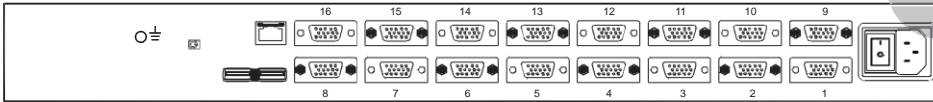

 The power of the KVM rear kit may be changed to external power design based on the LCD console drawer series and model.

KPH802



Power

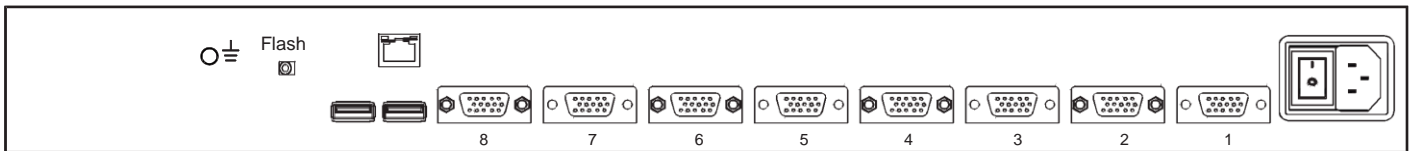

2 x USB 2.0
(USB hub for device connection)

KPH1602

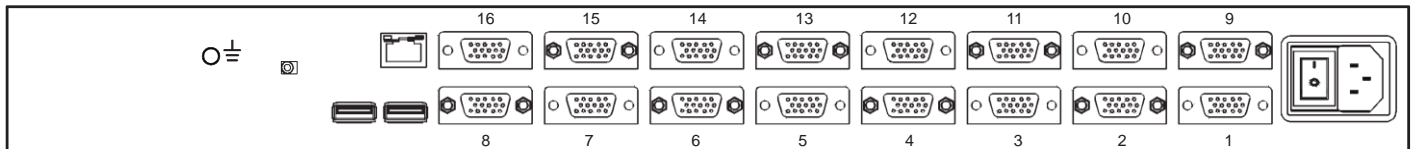

Daisy-chain feature for this model is NOT available.

< 1.2 > KVM port connection

- 6 / 10 / 15 ft USB KVM cable
- Support USB server



USB Servers

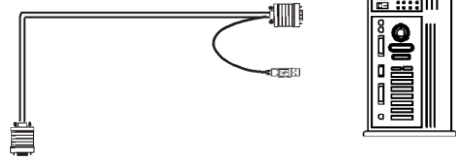

USB KVM port

Drawer KVM Rear Kit

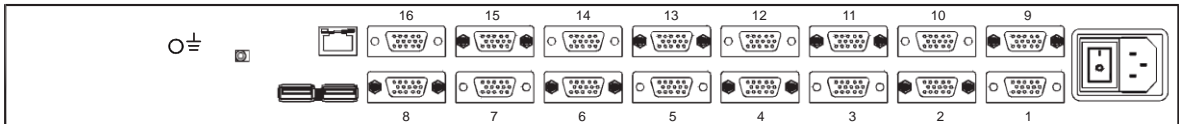

USB Servers



USB KVM cable support USB server

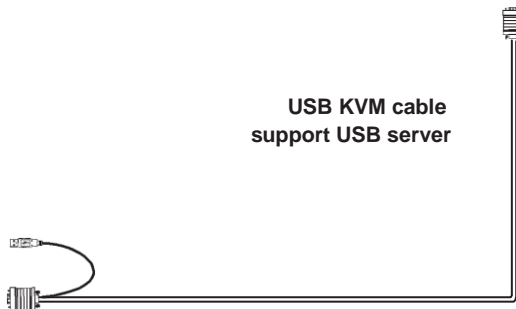

< 1.3 > IP console connection

CAT 5 / 6 cable
max. 100m

Network device
hub or router

Internet

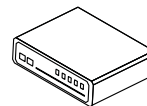

Drawer KVM Rear Kit

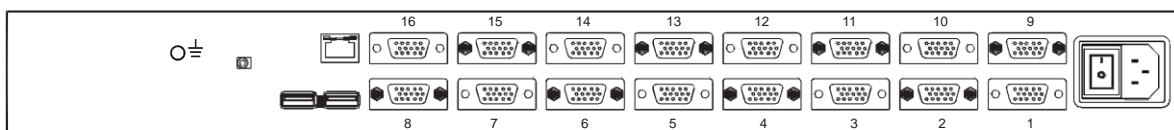

< 1.4 > IP console setting

After the cable connection, please take the following steps to configure the IP KVM :

1. Download [IPKVMsetup.exe](#)
2. Double click [IPKVMsetup.exe](#) to configure the IP KVM by device setup as below.

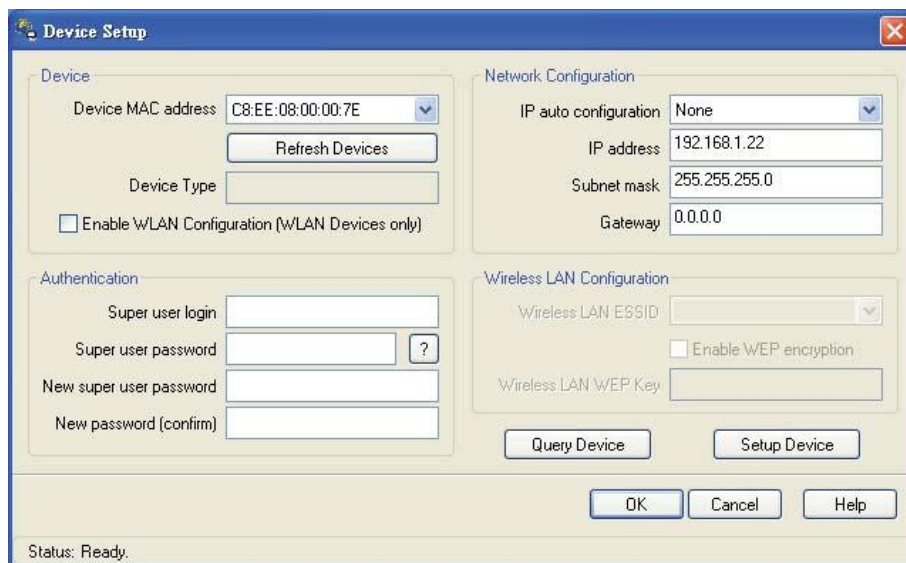

The screenshot shows the 'Device Setup' window with the following sections:

- Device:** Device MAC address: C8:EE:08:00:00:7E (dropdown), Refresh Devices button, Device Type (dropdown), Enable WLAN Configuration (WLAN Devices only).
- Network Configuration:** IP auto configuration: None (dropdown), IP address: 192.168.1.22, Subnet mask: 255.255.255.0, Gateway: 0.0.0.0.
- Authentication:** Super user login, Super user password, New super user password, New password (confirm).
- Wireless LAN Configuration:** Wireless LAN ESSID (dropdown), Enable WEP encryption, Wireless LAN WEP Key.

Buttons: Query Device, Setup Device, OK, Cancel, Help. Status: Ready.

3. Click **Refresh Device** to search the connected IP KVM
4. Select the M.A.C. address, which you want to setup, then click **Query Device**
5. Enter Super user login. **The default is super**
6. Enter Super user password. **The default is pass**
7. Enter the new super user password
8. Re-enter the new password
9. Change the desired IP address / Subnet mask / Gateway, then click **Setup Device** to confirm the setting to IP KVM
10. The default address is as below:--
 - The single IP KVM model, such as KPH1602 - http://192.168.1.22

11. Open Internet Explorer (I.E.), version 6.0 or above

12. Enter the IP KVM address into the address bar
- For Single IP - http://192.168.1.22

13. Enter username (default is super)
Password (default is pass)

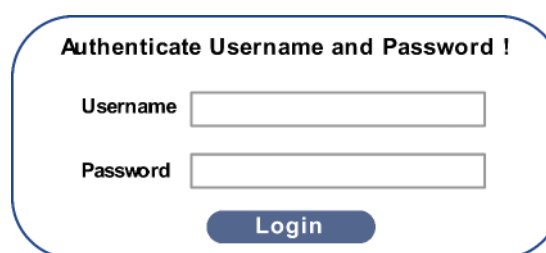

The screenshot shows a dialog box titled 'Authenticate Username and Password !' with the following fields and buttons:

- Username: [text input field]
- Password: [text input field]
- Login: [button]

14. After successful login to IP KVM, the user will enter the main page of IP KVM

< 1.5 > Built-in USB Hub Usage & Connection

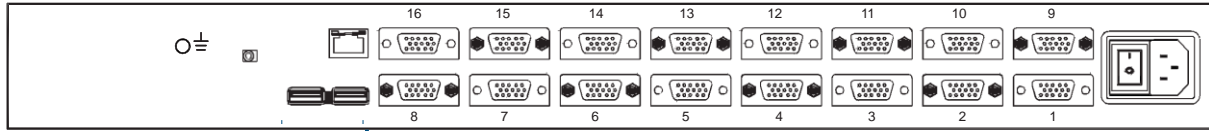

2 x USB 2.0 (USB hub for device connection)

-  Flash Disk
-  Hard disk storage
-  Keyboard / Mouse
-  Scanner
-  Printer
-  Camera

< 1.6 > Specifications

	KPH802	KPH1602
■ KVM Port Number of ports: Connector: Connectivity:	8 or 16 Combo connector Combo 2-in-1 VGA + USB KVM cable, 6, 10 or 15 feet	
■ USB Hub	2 x USB type A for sharing other peripheral devices among the computers	
■ IP Remote Console Connector: User management: Network protocol: Security: Resolution: Browser:	RJ45 Ethernet 15-user login, 1 x active user DHCP / BOOTP / DNS SSL v3, RSA, AES, HTTP / HTTPS, CSR Up to 1600 x 1200 IE, Firefox, Safari, Netscape	
■ Compatibility Multi-platform: Support:	Mix PCs, SUN and Mac G3 / G4 Mac / iMac Windows 7 / Vista / 2003 / XP, Linux, Unix	
■ Power Input: Option DC: Consumption:	100 or 240V AC at 50 or 60 Hz via IEC type cord 12V / 24V / 48V DC input Max. 48 Watt, Standby 5 Watt	
■ Regulatory Approval:	FCC, CE	
■ Environmental Operating: Storage: Relative humidity: Shock: Vibration:	0 to 50°C -5 to 60°C 90%, non-condensing 50G peak acceleration (11ms, half-sine wave) 58~100Hz / 0.98G (11ms / cycle)	

Part 2. USB Hub DB-15 2-console KVM

< 2.1 > Package Contents

KVS802 / 1602

- Receiver box for remote console x 1
- Power adapter w/ power cord (for receiver) x 1
- 6ft Combo KVM cable for receiver box x 1

KVM Rear Kit

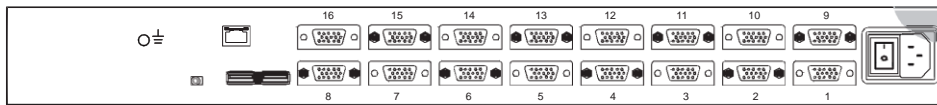

back



The power of the KVM rear kit may be changed to external power design based on the LCD console drawer series and model.

KVS802

Remote

Power

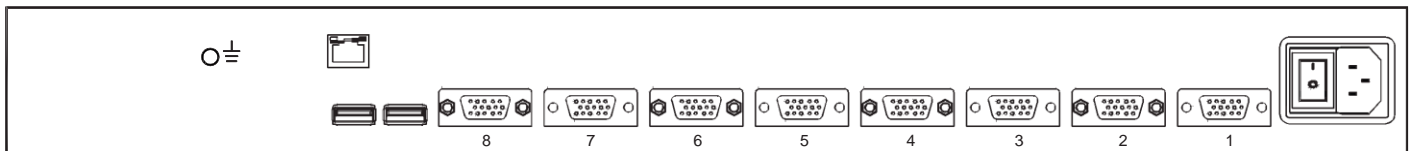

2 x USB 2.0
(USB hub for device connection)

KVS1602

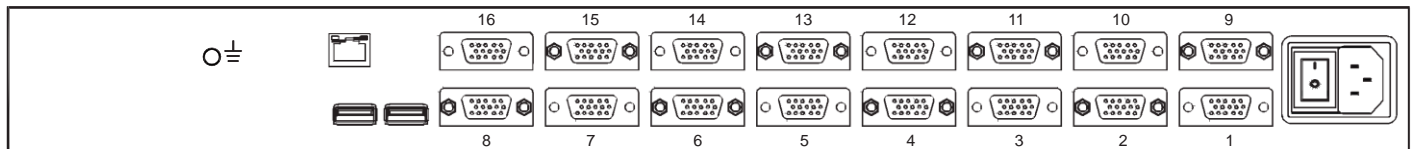

Daisy-chain feature for this model is NOT available.

< 2.2 > KVM port connection

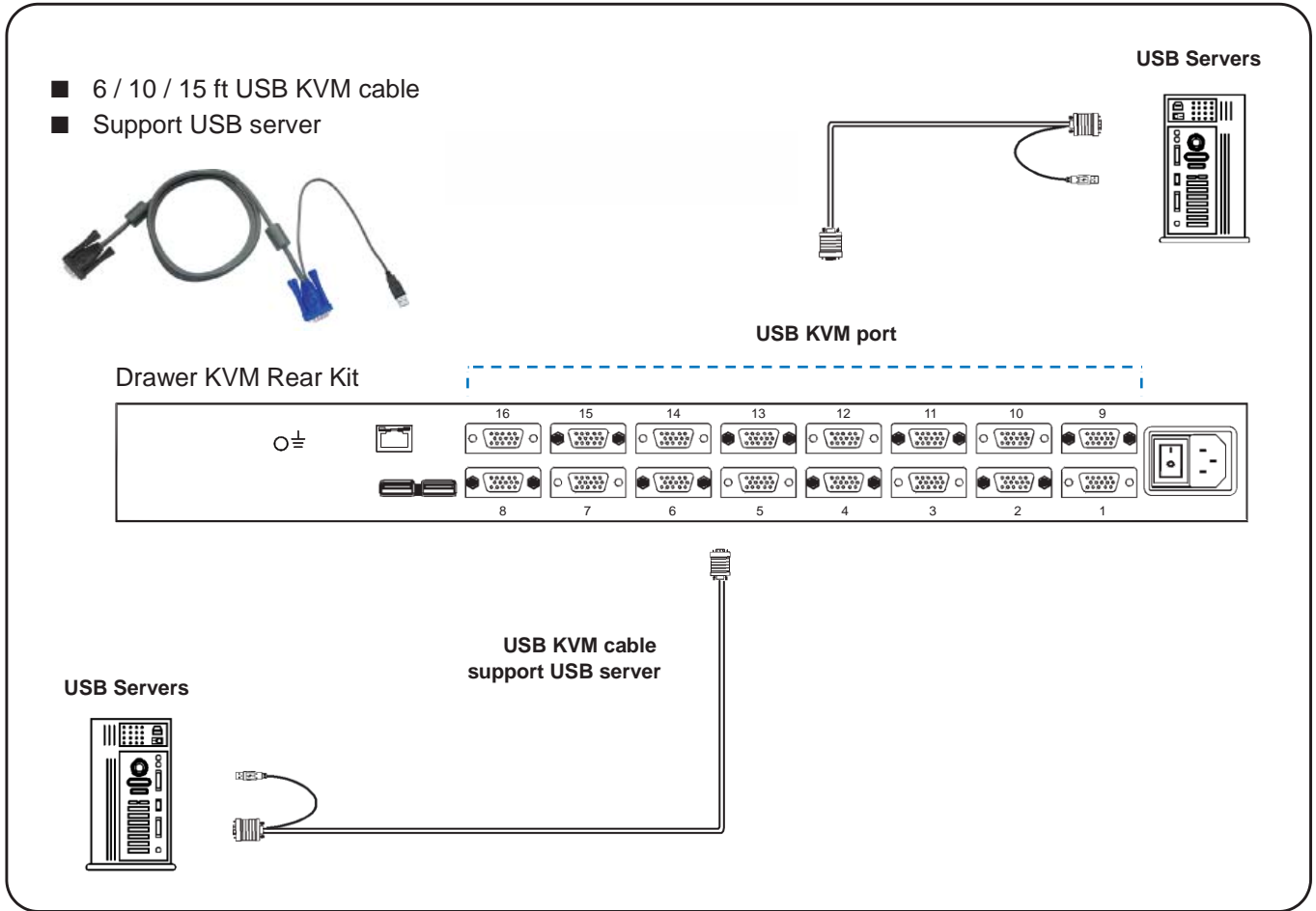

< 2.3 > Remote console connection

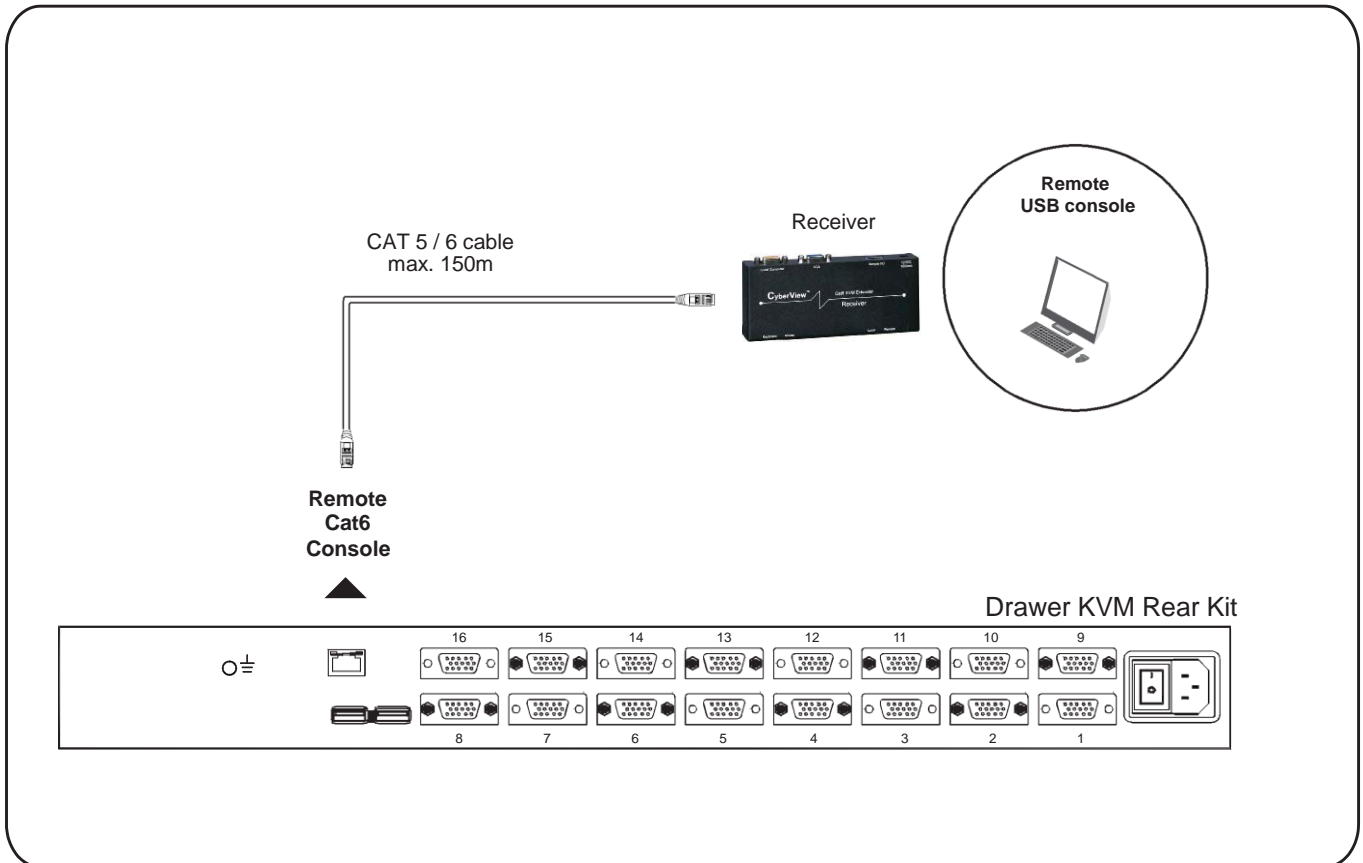

How to use a receiver to connect a remote console

Receiver

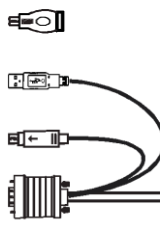
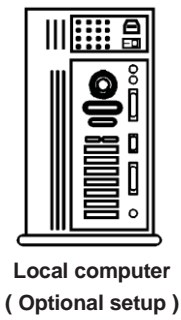
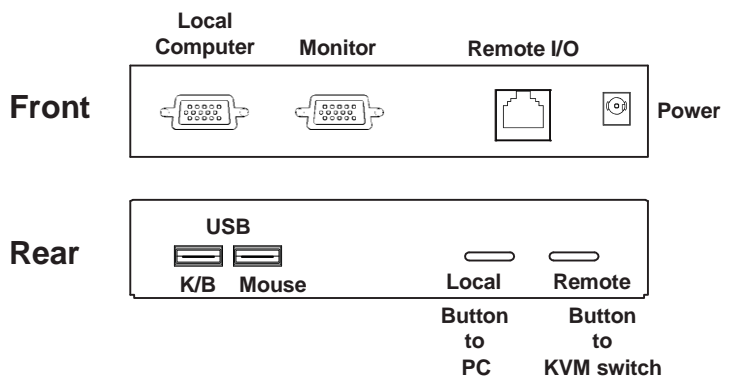

Combo KVM cable



VGA cable

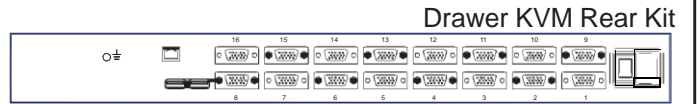

Remote Console



Cat6 cable up to 150m

12V DC Power Adapter

Front

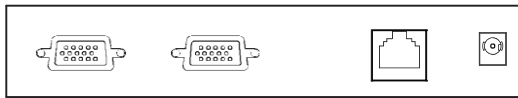

Rear

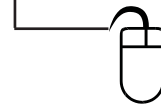
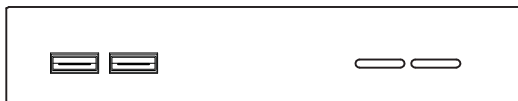

< 2.4 > Built-in USB Hub Usage & Connection

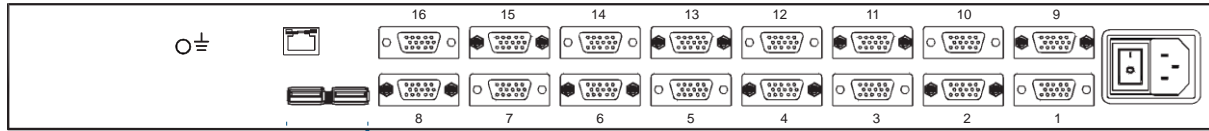

2 x USB 2.0 (USB hub for device connection)

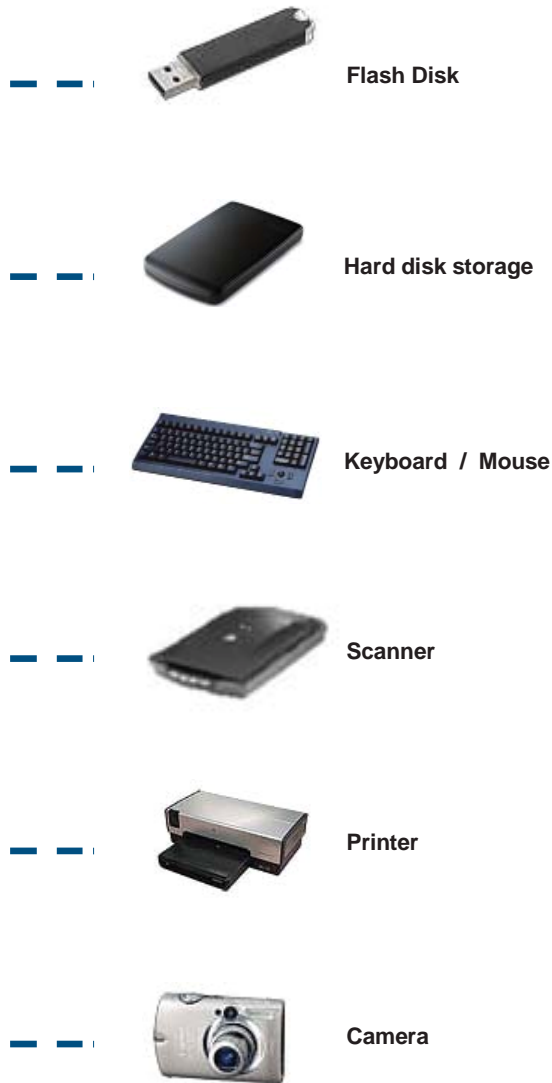

< 2.5 > Specifications

	KVS802	KVS1602
■ KVM Port Number of ports: 8 or 16 Connector: Combo connector Connectivity: Combo 2-in-1 VGA + USB KVM cable, 6, 10 or 15 feet		
■ USB Hub 2 x USB type A for sharing other peripheral devices among the computers		
■ Remote Console Connector: 1 x DB 15-pin, VGA Resolution: Up to 1600 x 1200 Input device: 2 x USB type A for keyboard & mouse Remote I/O: RJ45 via Cat5 / Cat5e / Cat6 cable up to 150m Compensation: Auto adjust for cable length		
■ Compatibility Multi-platform: Mix PCs, SUN and Mac G3 / G4 Mac / iMac Support: Windows 7 / Vista / 2003 / XP, Linux, Unix		
■ Power Input: 100 or 240V AC at 50 or 60 Hz via IEC type cord Option DC: 12V / 24V / 48V DC input Consumption: Max. 48 Watt, Standby 5 Watt		
■ Regulatory Approval: FCC, CE		
■ Environmental Operating: 0 to 50°C Storage: -5 to 60°C Relative humidity: 90%, non-condensing Shock: 50G peak acceleration (11ms, half-sine wave) Vibration: 58~100Hz / 0.98G (11ms / cycle)		

Part 3. USB Hub DB-15 KVM

< 3.1 > Package Contents

KVH801 / 1601

KVM Rear Kit

back

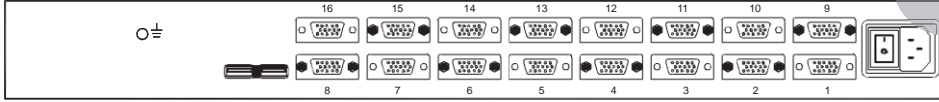

! The power of the KVM rear kit may be changed to external power design based on the LCD console drawer series and model.

KVH801

Power

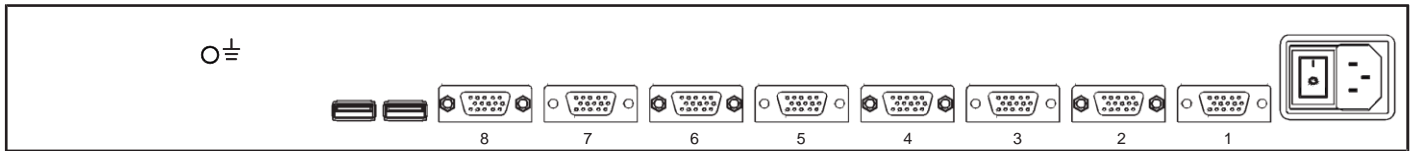

2 x USB 2.0
(USB hub for device connection)

KVH1601

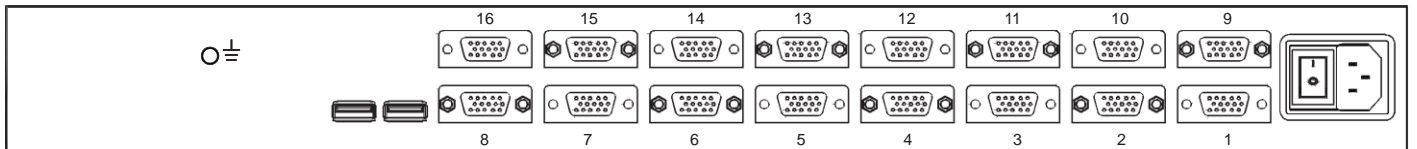

! Daisy-chain feature for this model is NOT available.

< 3.2 > KVM port connection

- 6 / 10 / 15 ft USB KVM cable
- Support USB server



USB Servers

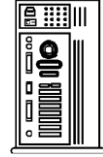

USB KVM port

Drawer KVM Rear Kit

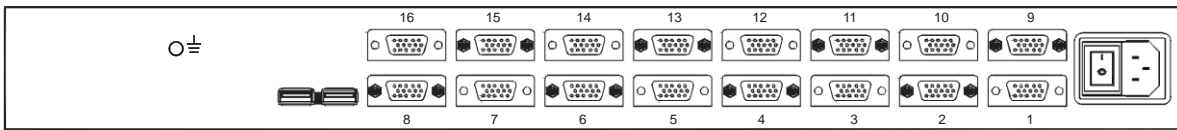

USB Servers

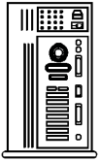

USB KVM cable
support USB server

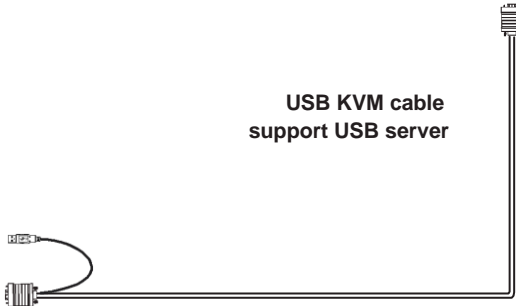

< 3.3 > Built-in USB Hub Usage & Connection

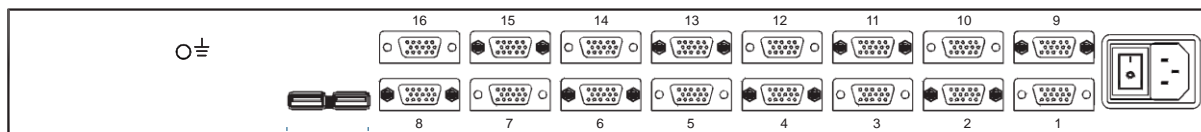

2 x USB 2.0 (USB hub for device connection)

-  Flash Disk
-  Hard disk storage
-  Keyboard / Mouse
-  Scanner
-  Printer
-  Camera

< 3.4 > Specifications

	KVH801	KVH1601
■ KVM Port Number of ports: Connector: Connectivity:	8 or 16 Combo connector Combo 2-in-1 VGA + USB KVM cable, 6, 10 or 15 feet	
■ USB Hub	2 x USB type A for sharing other peripheral devices among the computers	
■ Management Multilingual OSD: Hotkey combination: Security: PC Selection:	English, France, German, Spanish, Italian, Russian, Simplified Chinese, Japanese Scroll-lock, Cap-lock, Num-lock, Alt, Ctrl & Win Password enable & disable, up to 8 users profile for port access Front button, OSD menu & hotkey	
■ Compatibility Multi-platform: Support:	Mix PCs, SUN and Mac G3 / G4 Mac / iMac Windows 7 / Vista / 2003 / XP, Linux, Unix	
■ Power Input: Option DC: Consumption:	100 or 240V AC at 50 or 60 Hz via IEC type cord 12V / 24V / 48V DC input Max. 48 Watt, Standby 5 Watt	
■ Regulatory Approval:	FCC, CE	
■ Environmental Operating: Storage: Relative humidity: Shock: Vibration:	0 to 50°C -5 to 60°C 90%, non-condensing 50G peak acceleration (11ms, half-sine wave) 58~100Hz / 0.98G (11ms / cycle)	

Part 4. Usage

4.1 KVM Button

Power ON

- Turn off all servers and KVM switches
- Make sure all cables / connectors are properly connected
- Recommend Power ON sequence is monitor, KVM switch finally computer

Front Panel - Port LED Indications

USB Hub DB-15 KVM 8 ports

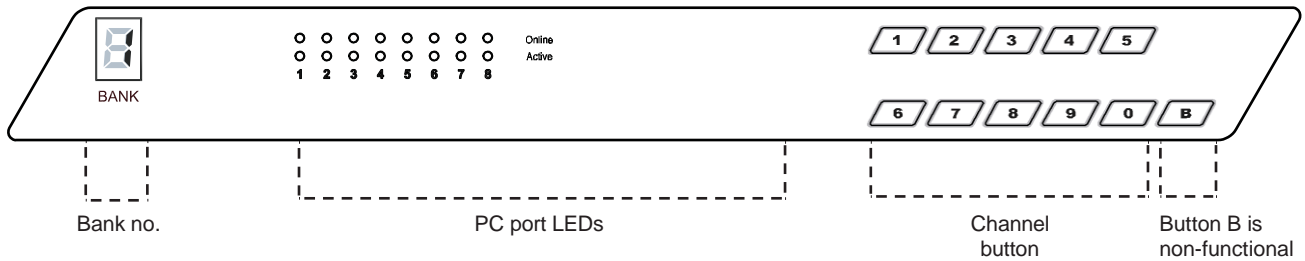

USB Hub DB-15 KVM 16 ports

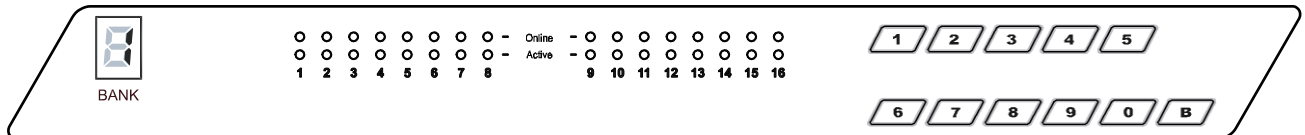

Bank no.	7-Segment BANK LED indication (Bank 1 only)
PC port LEDs	Online : Blue LED on indicating a PC is connecting to the port Active : Green LED on indicating a selected channel
Channel button	Press to select channel from 01 to 16

4.2 Password

The password is enabled by default, the default password is “00000000” eight zeros (**Do not use “0” on number pad**)

■ Enable password

1. Press the KVM hotkey **Scroll Lock + Scroll Lock + U**
2. Logout the KVM by pressing the hotkey **Scroll Lock + Scroll Lock + P**
3. In SUPERVISOR level, enter “00000000” eight zeros in user name & password field (**Do not use “0” on number pad**)
4. In USER level, press **Space bar + Enter** in user name & password field

Remark: Automatic logout after 10 minutes of inactivity

■ Set your own user name & password

1. Login the KVM in SUPERVISOR level by pressing “00000000” eight zeros in user name & password field
2. Call KVM OSD menu by pressing the KVM hotkey **Scroll Lock + Scroll Lock + Space Bar**
3. Press **F1** to the MAIN MENU
4. Select “USER SECURITY”
5. Set password in SUPERVISOR & USER level
 - a. In the left-top row “S” (SUPERVISOR), press **Enter** to set your own user name & password
 - b. In the row 1 to 8 (USER), press **Enter** to set your own user name & password
6. Press **Enter** to save the setting or press **Esc** to cancel the editing without any change

Remark: a. Blank has underscore, while SPACE doesn't have

- b. Press any alphanumeric key to move to next input item. SPACE is treated as a valid character

■ Change your password

1. Login the KVM in SUPERVISOR level by pressing your own user name & password
2. Call KVM OSD menu by pressing the KVM hotkey **Scroll Lock + Scroll Lock + Space Bar**
3. Press **F1** to the MAIN MENU
4. Select “USER SECURITY”
5. Change password in SUPERVISOR & USER level
 - a. In the left-top row “S” (SUPERVISOR), press **Enter** to change your user name & password
 - b. In the row 1 to 8 (USER), press **Enter** to change your user name & password
6. Press **Enter** to save the setting or press **Esc** to cancel the editing without any change

Remark: a. Blank has underscore, while SPACE doesn't have

- b. Press any alphanumeric key to move to next input item. SPACE is treated as a valid character

■ Disable your password

1. Press the KVM hotkey **Scroll Lock + Scroll Lock + U**
2. Logout the KVM by pressing the KVM hotkey **Scroll Lock + Scroll Lock + P**
3. You don't need user name & password to access the KVM OSD menu

■ Forget your password

Please contact your supplier for further support

Remark:



- You must press the KVM hotkey within 2 seconds
- A beep sound will be heard for successful entering KVM hotkey

4.3 KVM OSD

OSD Menu

PORT NAME	
BANK : 1	
01☼ SYSTEM 01	F1 : MENU
02☼ SYSTEM 02	F2 : LOGOUT
03☼ SYSTEM 03	F3 : PREV
04☼ SYSTEM 04	ESC : QUIT
05☼ SYSTEM 05	ENTER : COMPLETE
06☼ SYSTEM 06	↑/↓ : SELECT
07☼ SYSTEM 07	
08☼ SYSTEM 08	
USER : SUPERVISOR	
SCAN TIME : 10 SEC FW1V1	

OSD operation

 next to the system name	The PC is powered on
 next to the system name	The PC is selected
F1	Access F1 MAIN MENU
F2	Logout the OSD menu
F3	Previous menu
Esc	Cancel / Quit
Enter	Complete / Switch to selected port
↑/↓	Switch to previous or next port

F1 Main Menu

MAIN MENU	
SELECT OPTION :	
01	LANGUAGE
02	PORT NAME EDIT
03	PORT SEARCH
04	USER SECURITY
05	ACCESS LIST
06	HOTKEY
07	TIME SETTINGS
08	OSD MOUSE

01 LANGUAGE	OSD language change
02 PORT NAME EDIT	Define port name
03 PORT SEARCH	Quick searching by port name
04 USER SECURITY	Change password
05 ACCESS LIST	Define user access authority
06 HOTKEY	Change hotkey
07 TIME SETTINGS	Modify scan display time interval
08 OSD MOUSE	Modify OSD mouse speed

Local Console Hotkey	Function
Scroll Lock + Scroll Lock + Space Bar	Calling OSD menu
Right-button mouse + Esc	Calling OSD menu
Scroll Lock + Scroll Lock + ↑	Switch to previous port
Scroll Lock + Scroll Lock + ↓	Switch to next port
Scroll Lock + Scroll Lock + Port no.	Switch to specific port
Scroll Lock + Scroll Lock + B	Turn the buzzer ON and OFF * Default the buzzer is ON
Scroll Lock + Scroll Lock + P	Logout the KVM if password security is ON. Show up the status windows

Advance hotkeys (for Supervisor login only)

Scroll Lock + Scroll Lock + S	Activate auto-scan mode for connected servers *Press any key to exit the auto-scan mode
Scroll Lock + Scroll Lock + R	Reset all the KVM settings to factory default *Except User Security settings
Scroll Lock + Scroll Lock + U	Disable and enable password security *Default security is ON
Scroll Lock + Scroll Lock + L	To enable / disable the screen saving function and 10 minutes auto-logout *Default the screen saving is OFF

Remarks:

- Example of “**Scroll Lock + Scroll Lock + Port no.**”
 - Port No. : 01 to 16
 - e.g. Port 4 : **Scroll Lock + Scroll Lock + 0 + 4**
 - e.g. Port 16 : **Scroll Lock + Scroll Lock + 1 + 6**
- You must press the hotkey within 2 seconds
- A beep sound will be heard for successful entering
- The numeric keypad is not supported, while in OSD screen, the arrow keys, and Enter keys are supports

Remote Console Hotkey	Function
Scroll Lock + Scroll Lock + C	Toggle switch between remote & local port
Scroll Lock + Scroll Lock + Q	Turn the buzzer ON & OFF *Default the buzzer is ON
Scroll Lock + Scroll Lock + S	Activate auto-scan mode for remote & local port *The scan time interval is 5 seconds
Scroll Lock + Scroll Lock + A	Auto-adjust the video signal

4.5 DC Power 12V, 24V, 48V Input

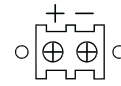
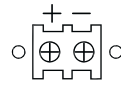
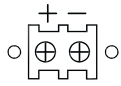

Model	12V	24V	48V
Input rating			
Input voltage:	12-Volt	24-Volt	48-Volt
Input range:	9 ~ 18V	18 ~ 36V	36 ~ 75V
Input current			
- No load	50 mA	50 mA	50 mA
- Full load	4950 mA	2450 mA	1220 mA
Output rating			
Output voltage:	12-Volt	12-Volt	12-Volt
Output current:	4.16A	4.16A	4.16A
Efficiency	84%	85%	85%

Remarks:

- Package does not include power cord