

Chromebook

Quick Guide

Product registration

When using your product for the first time, it is recommended that you immediately register it. This will give you access to some useful benefits, such as:

- Faster service from our trained representatives.
- Membership in the Acer community: receive promotions and participate in customer surveys.
- The latest news from Acer.

Hurry and register, as other advantages await you!

How to register

To register your Acer product, please visit **www.acer.com**. Select your country, click **PRODUCT REGISTRATION** and follow the simple instructions.

You will also be asked to register your product during the setup process, or you can double-click the Registration icon on the desktop.

After we receive your product registration, you will be sent a confirmation email with important data that you should keep in a safe place.

Obtaining Acer accessories

We are happy to inform you that Acer's warranty extension program and Notebook accessories are available online. Come and visit our online shop and find what you need at **store.acer.com**.

The Acer store is being progressively rolled out, and, unfortunately may not be available in some regions. Please check back regularly to see when it will be available in your country.

© 2012. All Rights Reserved.

Chromebook Quick Guide
Original Issue: 09/2012

Model number: _____

Serial number: _____

Date of purchase: _____

Place of purchase: _____

Information for your safety and comfort

Safety instructions

Read these instructions carefully. Keep this document for future reference. Follow all warnings and instructions marked on the product.

Turning the product off before cleaning

Unplug this product from the wall outlet before cleaning. Do not use liquid cleaners or aerosol cleaners. Use a damp cloth for cleaning.

CAUTION for plug as disconnecting device

Observe the following guidelines when connecting and disconnecting power to the power supply unit:

Install the power supply unit before connecting the power cord to the AC power outlet.

Unplug the power cord before removing the power supply unit from the computer.

If the system has multiple sources of power, disconnect power from the system by unplugging all power cords from the power supplies.

CAUTION for Accessibility

Be sure that the power outlet you plug the power cord into is easily accessible and located as close to the equipment operator as possible. When you need to disconnect power to the equipment, be sure to unplug the power cord from the electrical outlet.

CAUTION for bundled dummy cards (only for certain models)

Your computer shipped with plastic dummies installed in the card slots. Dummies protect unused slots from dust, metal objects or other particles. Save the dummies for use when no cards are in the slots.

Warnings

- Do not use this product near water.
- Do not place this product on an unstable cart, stand or table. If the

product falls, it could be seriously damaged.

- Slots and openings are provided for ventilation to ensure reliable operation of the product and to protect it from overheating. These openings must not be blocked or covered. The openings should never be blocked by placing the product on a bed, sofa, rug or other similar surface. This product should never be placed near or over a radiator or heat register, or in a built-in installation unless proper ventilation is provided.
- Never push objects of any kind into this product through cabinet slots as they may touch dangerous voltage points or short-out parts that could result in a fire or electric shock. Never spill liquid of any kind onto or into the product.
- To avoid damage of internal components and to prevent battery leakage, do not place the product on a vibrating surface.
- Never use it under sporting, exercising, or any vibrating environment which will probably cause unexpected short current or damage rotor devices, HDD, optical drive, and even exposure risk from lithium battery pack.
- The bottom surface, areas around ventilation openings and AC adapter may get hot. To avoid injury, ensure they do not come in contact with your skin or body.



.....
Note: Reduce the risk of heat-induced injury or fire by adhering to the following:

- 1) Do not place the computer or AC adapter on a soft surface, such as a bed.
 - 2) Do not rest the computer or AC adapter on your lap for extended periods.
 - 3) Use the computer on a flat, hard surface, such as a desk.
 - 4) Ensure that the ventilation is not obstructed.
- Your device and its enhancements may contain small parts. Keep them out of the reach of children.
 - The surface temperature of the base will rise during normal operation, particularly when AC power is present. Allowing sustained contact with exposed skin can cause discomfort.

Using electrical power

- This product should be operated from the type of power indicated on the marking label. If you are not sure of the type of power available, consult your dealer or local power company.
- Do not allow anything to rest on the power cord. Do not locate this

product where people will walk on the cord.

- If an extension cord is used with this product, make sure that the total ampere rating of the equipment plugged into the extension cord does not exceed the extension cord ampere rating. Also, make sure that the total rating of all products plugged into the wall outlet does not exceed the fuse rating.
- Do not overload a power outlet, strip or receptacle by plugging in too many devices. The overall system load must not exceed 80% of the branch circuit rating. If power strips are used, the load should not exceed 80% of the power strip's input rating.
- This product's AC adapter is equipped with a three-wire grounded plug. The plug only fits in a grounded power outlet. Make sure the power outlet is properly grounded before inserting the AC adapter plug. Do not insert the plug into a non-grounded power outlet. Contact your electrician for details.



.....
Warning! The grounding pin is a safety feature. Using a power outlet that is not properly grounded may result in electric shock and/or injury.



.....
Note: The grounding pin also provides good protection from unexpected noise produced by other nearby electrical devices that may interfere with the performance of this product.

- The system can be powered using a wide range of voltages: 100 to 120 or 220 to 240 V AC. The power cord included with the system meets the requirements for use in the country/region where the system was purchased. Power cords for use in other countries/regions must meet the requirements for that country/region. For more information on power cord requirements, contact an authorized reseller or service provider.

Product servicing

Do not attempt to service this product yourself, as opening or removing covers may expose you to dangerous voltage points or other risks. Refer all servicing to qualified service personnel.

Unplug this product from the wall outlet and refer servicing to qualified service personnel when:

- The power cord or plug is damaged, cut or frayed.

- Liquid was spilled into the product.
- The product was exposed to rain or water.
- The product has been dropped or the case has been damaged.
- The product exhibits a distinct change in performance, indicating a need for service.
- The product does not operate normally after following the operating instructions.



.....

Note: Adjust only those controls that are covered by the operating instructions, since improper adjustment of other controls may result in damage and will often require extensive work by a qualified technician to restore the product to normal condition.

Guidelines for safe battery usage

This notebook uses a Lithium-ion battery. Do not use it in a humid, wet or corrosive environment. Do not put, store or leave your product in or near a heat source, in a high temperature location, in strong direct sunlight, in a microwave oven or in a pressurized container, and do not expose it to temperatures over 60° C (140° F). Failure to follow these guidelines may cause the battery to leak acid, become hot, explode or ignite and cause injury and/or damage. Do not pierce, open or disassemble the battery. If the battery leaks and you come into contact with the leaked fluids, rinse thoroughly with water and seek medical attention immediately. For safety reasons, and to prolong the lifetime of the battery, charging will not occur at temperatures below 0° C (32° F) or above 40° C (104° F).

The full performance of a new battery is achieved only after two or three complete charge and discharge cycles. The battery can be charged and discharged hundreds of times, but it will eventually wear out. When the operation time becomes noticeably shorter than normal, buy a new battery. Use only the approved batteries, and recharge your battery only with the approved chargers designated for this device.

Use the battery only for its intended purpose. Never use any charger or battery that is damaged. Do not short-circuit the battery. Accidental short-circuiting can occur when a metallic object such as a coin, clip or pen causes direct connection of the positive (+) and negative (-) terminals of the battery. (These look like metal strips on the battery.) This might happen, for example, when you carry a spare battery in your pocket or purse. Short-circuiting the terminals may damage the battery or the connecting object.

The capacity and lifetime of the battery will be reduced if the battery is left in hot or cold places, such as in a closed car in summer or winter. Always

try to keep the battery between 15° C and 25° C (59° F and 77° F). A device with a hot or cold battery may not work temporarily, even when the battery is fully charged. Battery performance is especially limited in temperatures well below freezing.

Do not dispose of batteries in a fire as they may explode. Batteries may also explode if damaged. Dispose of batteries according to local regulations. Please recycle when possible. Do not dispose as household waste.

Wireless devices may be susceptible to interference from the battery, which could affect performance.

Replacing the battery pack

The notebook uses lithium batteries. Replace the battery with the same type as that which came bundled with your product. Use of another battery may present a risk of fire or explosion.



.....

Warning! Batteries may explode if not handled properly. Do not disassemble or dispose of them in fire. Keep them away from children. Follow local regulations when disposing of used batteries.

Radio frequency interference



.....

Warning! For safety reasons, turn off all wireless or radio transmitting devices when using your laptop under the following conditions. These devices may include, but are not limited to: wireless LAN (WLAN), Bluetooth and/or 3G.

Remember to follow any special regulations in force in any area, and always switch off your device when its use is prohibited or when it may cause interference or danger. Use the device only in its normal operating positions. This device meets RF exposure guidelines when used normally. It should not contain metal and you should position the device the above-stated distance from your body. To successfully transmit data files or messages, this device requires a good quality connection to the network. In some cases, transmission of data files or messages may be delayed until such a connection is available. Ensure that the above separation distance instructions are followed until the transmission is completed. Parts of the device are magnetic. Metallic materials may be attracted to the device, and persons with hearing aids should not hold the device to the ear with the

hearing aid. Do not place credit cards or other magnetic storage media near the device, because information stored on them may be erased.

Medical devices

Operation of any radio transmitting equipment, including wireless phones, may interfere with the functionality of inadequately protected medical devices. Consult a physician or the manufacturer of the medical device to determine if they are adequately shielded from external RF energy or if you have any questions. Switch off your device in health care facilities when any regulations posted in these areas instruct you to do so. Hospitals or health care facilities may be using equipment that could be sensitive to external RF transmissions.

Pacemakers. Pacemaker manufacturers recommend that a minimum separation of 15.3 centimeters (6 inches) be maintained between wireless devices and a pacemaker to avoid potential interference with the pacemaker. These recommendations are consistent with the independent research by and recommendations of Wireless Technology Research. Persons with pacemakers should do the following:

- Always keep the device more than 15.3 centimeters (6 inches) from the pacemaker
- Not carry the device near your pacemaker when the device is switched on.
If you suspect interference, switch off your device, and move it.

Hearing aids. Some digital wireless devices may interfere with some hearing aids. If interference occurs, consult your service provider.

Vehicles

RF signals may affect improperly installed or inadequately shielded electronic systems in motor vehicles such as electronic fuel injection systems, electronic anti-skid (anti-lock) braking systems, electronic speed control systems, and air bag systems. For more information, check with the manufacturer, or its representative, of your vehicle or any equipment that has been added. Only qualified personnel should service the device, or install the device in a vehicle. Faulty installation or service may be dangerous and may invalidate any warranty that may apply to the device. Check regularly that all wireless equipment in your vehicle is mounted and operating properly. Do not store or carry flammable liquids, gases, or explosive materials in the same compartment as the device, its parts, or enhancements. For vehicles equipped with an air bag, remember that air bags inflate with great force. Do not place objects, including installed or portable wireless equipment in the area over the air bag or in the air bag

deployment area. If in-vehicle wireless equipment is improperly installed, and the air bag inflates, serious injury could result. Using your device while flying in aircraft is prohibited. Switch off your device before boarding an aircraft. The use of wireless teledevices in an aircraft may be dangerous to the operation of the aircraft, disrupt the wireless telephone network, and may be illegal.

Potentially explosive environments

Switch off your device when in any area with a potentially explosive atmosphere and obey all signs and instructions. Potentially explosive atmospheres include areas where you would normally be advised to turn off your vehicle engine. Sparks in such areas could cause an explosion or fire resulting in bodily injury or even death. Switch off the device at refueling points such as near gas pumps at service stations. Observe restrictions on the use of radio equipment in fuel depots, storage, and distribution areas; chemical plants; or where blasting operations are in progress. Areas with a potentially explosive atmosphere are often, but not always, clearly marked. They include below deck on boats, chemical transfer or storage facilities, vehicles using liquefied petroleum gas (such as propane or butane), and areas where the air contains chemicals or particles such as grain, dust or metal powders. Do not switch the notebook on when wireless phone use is prohibited or when it may cause interference or danger.

Emergency calls

Warning: You cannot make emergency calls through this device. To make an emergency call you shall dial out through your mobile phone or other telephone call system.

Disposal instructions

Do not throw this electronic device into the trash when discarding.

To minimize pollution and ensure utmost protection of the global environment, please recycle. For more information on the Waste from Electrical and Electronics Equipment (WEEE) regulations, visit www.acer-group.com/public/Sustainability/sustainability01.htm.



ENERGY STAR



Acer's ENERGY STAR qualified products save your money by reducing energy cost and protecting the environment without sacrificing features or performance. Acer is proud to offer our customers products with the ENERGY STAR mark.

What is ENERGY STAR?

Products that are ENERGY STAR qualified use less energy and prevent greenhouse gas emissions by meeting strict energy efficiency guidelines set by the U.S. Environmental Protection Agency. Acer is committed to offering products and services worldwide that help customers save money, conserve energy and improve the quality of our environment. The more energy we can save through higher energy efficiency, the more we reduce greenhouse gases and the risks of climate change. More information refers to

www.energystar.gov or www.energystar.gov/powermanagement.

Acer ENERGY STAR qualified products: (only for certain models)

- Produce less heat and reduce cooling loads, and warmer climates.
- Automatically go into "display sleep" and "computer sleep" mode after 10 and 30 minutes of inactivity respectively.
- Wake the computer from sleep mode by pushing keyboard or moving mouse.
- Computers will save more than 80% energy at "sleep" mode.

ENERGY STAR is only available for certain models and have the ENERGY STAR certification mark on the palm rest.

ENERGY STAR and the ENERGY STAR mark are registered U.S. marks

Tips and information for comfortable use

Computer users may complain of eyestrain and headaches after prolonged use. Users are also at risk of physical injury after long hours of working in front of a computer. Long work periods, bad posture, poor work habits, stress, inadequate working conditions, personal health and other factors greatly increase the risk of physical injury.

Incorrect computer usage may lead to carpal tunnel syndrome, tendonitis, tenosynovitis or other musculoskeletal disorders. The following symptoms may appear in the hands, wrists, arms, shoulders, neck or back:

- Numbness, or a burning or tingling sensation.
- Aching, soreness or tenderness.

- Pain, swelling or throbbing.
- Stiffness or tightness.
- Coldness or weakness.

If you have these symptoms, or any other recurring or persistent discomfort and/or pain related to computer use, consult a physician immediately and inform your company's health and safety department.

The following section provides tips for more comfortable computer use.

Finding your comfort zone

Find your comfort zone by adjusting the viewing angle of the monitor, using a footrest, or raising your sitting height to achieve maximum comfort.

Observe the following tips:

- Refrain from staying too long in one fixed posture.
- Avoid slouching forward and/or leaning backward.
- Stand up and walk around regularly to remove the strain on your leg muscles.
- Take short rests to relax your neck and shoulders.
- Avoid tensing your muscles or shrugging your shoulders.
- Install the external display, keyboard and mouse properly and within comfortable reach.
- If you view your monitor more than your documents, place the display at the center of your desk to minimize neck strain.

Taking care of your vision

Long viewing hours, wearing incorrect glasses or contact lenses, glare, excessive room lighting, poorly focused screens, very small typefaces and low-contrast displays could stress your eyes. The following sections provide suggestions on how to reduce eyestrain.

Eyes

- Rest your eyes frequently.
- Give your eyes regular breaks by looking away from the monitor and focusing on a distant point.
- Blink frequently to keep your eyes from drying out.

Display

- Keep your display clean.
- Keep your head at a higher level than the top edge of the display so your eyes point downward when looking at the middle of the display.

- Adjust the display brightness and/or contrast to a comfortable level for enhanced text readability and graphics clarity.
- Eliminate glare and reflections by:
 - placing your display in such a way that the side faces the window or any light source
 - minimizing room light by using drapes, shades or blinds
 - using a task light
 - changing the display's viewing angle
 - using a glare-reduction filter
 - using a display visor, such as a piece of cardboard extended from the display's top front edge
- Avoid adjusting your display to an awkward viewing angle.
- Avoid looking at bright light sources for extended periods of time.

Developing good work habits

The following work habits make computer use more relaxing and productive:

- Take short breaks regularly and often.
- Perform some stretching exercises.
- Breathe fresh air as often as possible.
- Exercise regularly and maintain a healthy body.



.....
Warning! We do not recommend using the computer on a couch or bed. If this is unavoidable, work for only short periods, take breaks regularly, and do some stretching exercises.

Table of contents

Information for your safety and comfort	i
Safety instructions	i
Radio frequency interference	v
Medical devices	vi
Vehicles	vi
Potentially explosive environments	vii
Emergency calls	vii
Disposal instructions	vii
Tips and information for comfortable use	viii
Getting started	1
Turn on your Chromebook	1
Select your language settings	1
Connect to a network	1
Accept the terms of service	1
Sign in with your Google Account	2
Create a new Google Account	2
Browse as a guest	2
Set your account picture	2
Your Acer Chromebook tour	4
Front view	4
Keyboard view	5
Hotkeys	6
Touchpad	7
Left view	7
Right view	8
Base view	9
Environment	9
Desktop	10
Desktop overview	10
Window controls	10
Launcher	11
Status area and settings	11
Apps	12
Managing apps	12

Installing apps to Chrome OS	12
Removing apps from Chrome OS	12
Customizing the apps pinned to the launcher	12
Google Drive	12
Sync files from Downloads to Google Drive	12
Enable offline access to Google Drive files	14
Gmail	14
Composing an email	14
Google Docs	14
Creating a new document	14
YouTube	14
Playing video or audio files	15
Chrome Web Store	15
Installing new apps from the Chrome Web Store	15
Settings	16
Changing the language settings	16
Changing the clock settings	17
Customizing the appearance	17
Customizing the wallpaper	17
Customizing the theme	17
Setting up a printer	18
Updating Chrome OS	18
Automatic update	18
Manual update	18
Help	19
Online and offline help	19
Regulations and safety notices	20
FCC notice	20
LCD pixel statement	21
Radio device regulatory notice	21
General	22
European Union (EU)	22
The FCC RF safety requirement	23
Canada — Low-power license-exempt radio communication devices (RSS-210)	23

Getting started

Turn on your Chromebook

On the Chromebook, the power button is located on the top-left corner of the keyboard.

Select your language settings

On the Connect screen that appears, select the language you would like to use by default. If there is more than one way to type in your language, you may be prompted to select a keyboard input method as well.

Connect to a network

Select a wireless network from the network menu. Alternatively, if your Chromebook has an Ethernet plug, you may plug in an Ethernet cable to connect to a wired network.

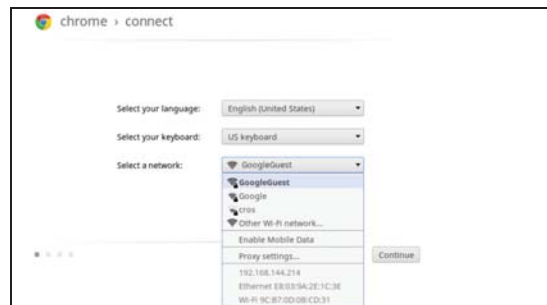

Accept the terms of service

Once connected to a network, your Chromebook will then download any available system updates so you automatically get the latest features.

Sign in with your Google Account

In the sign-in box that appears, enter your Google Account username and password and click **Sign in**.



Important: Sign in with your primary Google Account. This account will be set as the owner and is the only account that will be able to change certain settings.

Create a new Google Account

Click **Create a Google Account** on the right to set up a new account. A Google Account gives you access to useful web services developed by Google, such as Gmail, Google Docs, and Google Calendar.

Browse as a guest

You can also use the Chromebook without a Google Account by clicking **Browse as a Guest** on the right.

Set your account picture

This picture will represent your account on the main sign-in screen and status area. If your Chromebook has a built-in webcam, you can use it to take a photo. If you don't want to take a photo at this time, choose an icon instead. You can always update your picture after you've signed in.

Furthermore, your Chromebook is integrated with your Google Account profile. After signing in with your Google Account you will also have the option of choosing your Google Account profile picture.

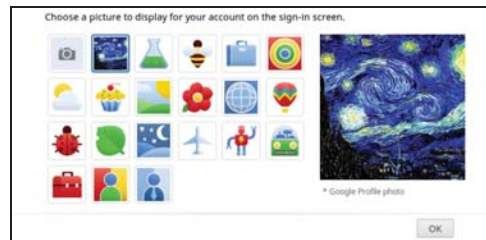



Your Acer Chromebook tour

After setting up your computer, let us show you around your new Acer Chromebook.

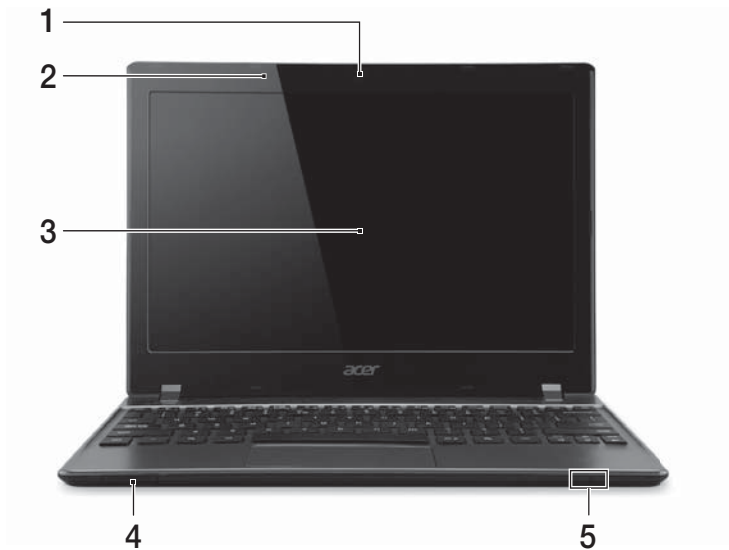
Front view



#	Icon	Item	Description
1		Webcam	Web camera for video communication. <i>A light next to the webcam indicates that the webcam is active (for selected models only).</i>
2		Microphone	Internal microphone for sound recording.
3		Screen	Displays computer output.
4		2-in-1 card reader	Accepts Secure Digital (SD), MultiMediaCard (MMC). Note: <i>Push to remove/install the card. Only one card can operate at any given time.</i>

#	Icon	Item	Description
		Power indicator	Indicates the computer's power status.
5		Battery indicator	Indicates the computer's battery status. 1. Charging: The light shows amber when the battery is charging. 2. Fully charged: The light shows blue when in AC mode.

Keyboard view



#	Icon	Item	Description
1		Power button / indicator	Turns the computer on and off. Indicates the computer's power status.
2		Keyboard	For entering data into your computer.

#	Icon	Item	Description
3		Touchpad / click button	Touch-sensitive pointing device which functions like a computer mouse. <i>Pressing down anywhere on the pad functions like the left button of a mouse.</i> <i>Pressing down anywhere with two fingers functions like the right button of a mouse.</i>

Hotkeys

The computer employs hotkeys or key combinations to access most of the computer's controls like screen brightness and volume output.

Icon	Hotkey	Function	Description
←	<F1>	Previous	Go to the previous page.
→	<F2>	Next	Go to the next page.
↻	<F3>	Reload	Reload your current page.
☐	<F4>	Full-screen	Open your page in full-screen mode.
☐☐☐	<F5>	Next window	Switch to your next window.
☼	<F6>	Brightness down	Decreases the screen brightness.
☼	<F7>	Brightness up	Increases the screen brightness.
🔇	<F8>	Mute	Mute the sound volume.
🔊	<F9>	Volume down	Decreases the sound volume.
🔊	<F10>	Volume up	Increases the sound volume.
📶	<FN> + <F11>	Communication	Enables/disables the computer's communication devices.

Icon	Hotkey	Function	Description
		Search	Search from the browser's address bar.



Touchpad



The built-in touchpad is a pointing device that senses movement on its surface. This means the cursor responds as you move your fingers across the surface of the touchpad.

Action	Gesture
Click	Just press down on any part of the touchpad.
Right-click	Click the touchpad with two fingers.
Scroll	Place two fingers on the touchpad and move them up and down to scroll vertically, left and right to scroll horizontally.
Drag and drop	Click the item you want to move with one finger. With a second finger, move the item. Release both fingers to drop the item.

Left view





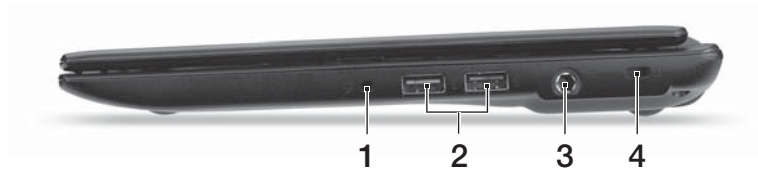

#	Icon	Item	Description
1		Ethernet (RJ-45) port	Connects to an Ethernet 10/100-based network.
2		External display (VGA) port	Connects to a display device (e.g., external monitor, LCD projector).

#	Icon	Item	Description
3		HDMI port	Supports high-definition digital video connections.
4		USB port	Connects to USB devices. <i>If a port is black it is USB 2.0 compatible, if it is blue it is also USB 3.0 compatible.</i>



Right view

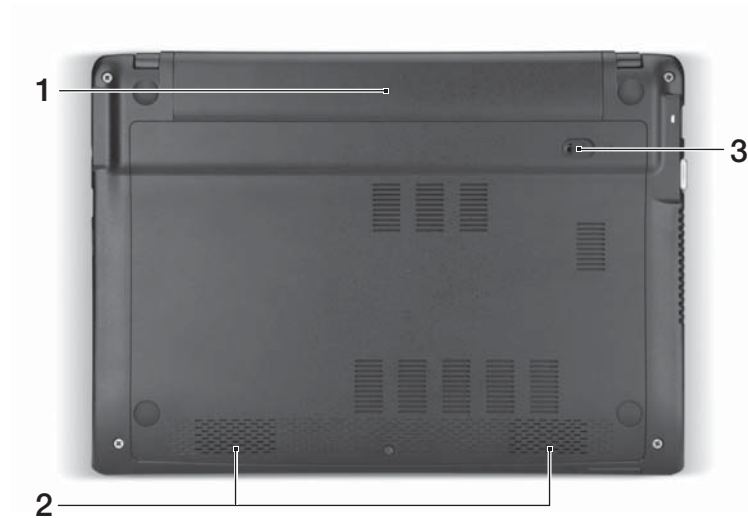

#	Icon	Item	Description
1		Headset/speaker jack	Connects to audio devices (e.g., speakers, headphones), or a headset with microphone.
2		USB port	Connects to USB devices. <i>If a port is black it is USB 2.0 compatible, if it is blue it is also USB 3.0 compatible.</i>
3		DC-in jack	Connects to an AC adapter.
4		Kensington lock slot	Connects to a Kensington-compatible computer security lock. Note: Wrap the computer security lock cable around an immovable object such as a table or handle of a locked drawer. Insert the lock into the notch and turn the key to secure the lock. Some keyless models are also available.

Base view



#	Icon	Item	Description
1		Battery bay	Houses the computer's battery pack.
2		Speakers	Left and right speakers deliver stereo audio output.
3		Battery release latch/lock	Releases the battery for removal. <i>Insert a suitable tool into the latch and slide to release.</i>

Environment







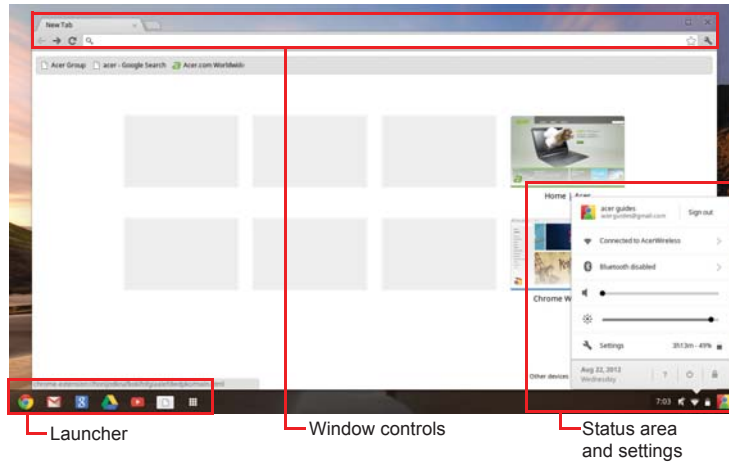

- Temperature:
 - Operating: 5 °C to 35 °C
 - Non-operating: -20 °C to 65 °C
- Humidity (non-condensing):
 - Operating: 20% to 80%
 - Non-operating: 20% to 80%

Desktop







Desktop overview











Window controls

Icon	Description	Icon	Description
	Close the tab		Create a new tab
	Back to the previous page		Go to the next page
	Reload the page		Search
	Minimize, maximize, or dock the window on the left or right		Bookmark
	Settings		

Launcher

Icon	Description	Icon	Description
	Open a new Chrome browser tab		Gmail
	Google Search		YouTube
	Google Drive		See your apps list

Status area and settings

Icon	Description	Icon	Description
	Battery life		Shut down
	Brightness		Volume
	Chrome OS help		Wired network connection
	Settings		Wireless network connection
	Sign out		



.....
Note: Specifications vary. Some icons may not be applicable to your Chromebook.

Apps

Managing apps

Installing apps to Chrome OS

See "**Installing new apps from the Chrome Web Store**" on page 15.

Removing apps from Chrome OS

1. Click the apps list button (⌵).
2. Right-click (or click with two fingers) on the app you want to add to the launcher.
3. Select **Remove from Chrome**.

Customizing the apps pinned to the launcher

1. Click the apps list button (⌵).
2. Right-click on the app you want to add to the launcher.
3. Select **Pin to Launcher**.

To reorder the apps in the launcher, just drag them around.

Google Drive

All files saved to your **Google Drive** are saved online and are accessible to other devices, such as your smartphone or tablet. Files saved to the **Downloads** folder are saved to your local hard drive and only accessible to your Chromebook.



.....
Note: You must be connected to the Internet to do the following Google Drive operations.

Sync files from Downloads to Google Drive

1. In the apps list, click on the **Files** icon.

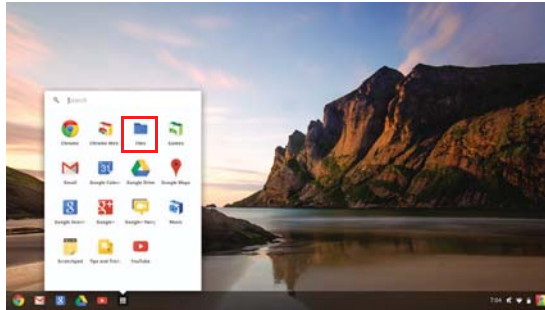

2. If this your first time accessing your Google Drive, click on the **Google Drive** icon to enable access.
3. Once your Google Drive is enabled, select the checkboxes next to all of the files that you want to upload.

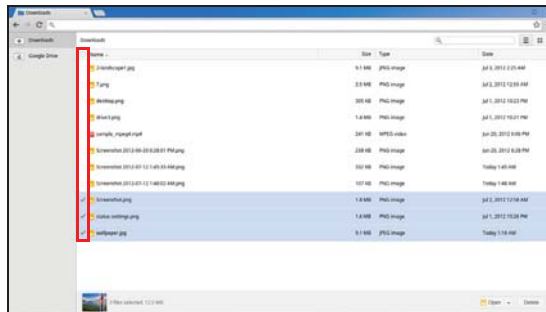

4. Drag-and-drop the files on to the **Google Drive** icon.

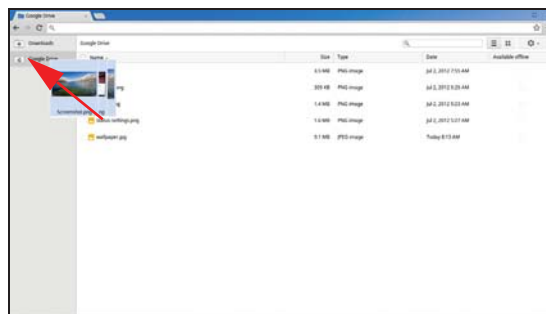

Enable offline access to Google Drive files

You can access files stored on your Google Drive while offline, but first you must enable offline access:

1. In the apps list, click on the **Files** icon.
2. Click on **Google Drive**.
3. In the **Available offline** column, place a tick next to all of the files that you want to be able to access offline.

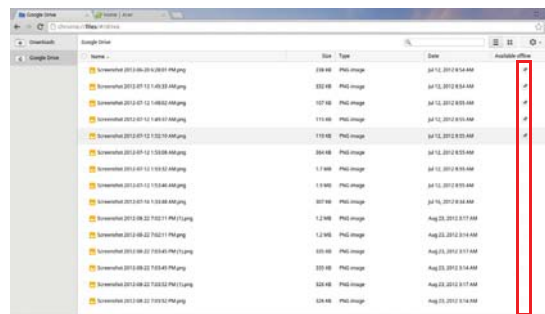

Gmail

Composing an email

1. From the launcher, click on the **Gmail** icon.
2. Click **COMPOSE**.
3. Enter the recipient's email address, the subject, and the message.
4. When you are finished composing your message, click **Send**.

Google Docs

Creating a new document

1. From the launcher, click on the **Google Drive** icon (.
2. Click on **CREATE** and select the type of document you want to create.

YouTube

YouTube is a video-sharing website on which users can upload, share and view videos. It can be quickly accessed by clicking the **YouTube** icon on the launcher.



Playing video or audio files

Your Chromebook has a built-in media player to play audio and video files. To play a file, simply double-click on an audio or video file in your **Files** app.

Media type	Supported formats
Audio / Video	.mp4, .m4v, .m4a, .mp3, .ogv, .ogm, .ogg, .oga, .webm, .wav

Chrome Web Store

Installing new apps from the Chrome Web Store

1. Click the apps list button () and then click on **Chrome Web Store**.
2. You can then browse through the app categories in the left column or search for a specific type of app using the search box.
3. When you find an app that you would like to add, hover your mouse over it and then click on **ADD TO CHROME**.
4. A verification window will pop up, click on **Add** to download and install the app, or click on **Cancel**.
5. To open your new app, click the apps list button () and then click on the app.

Settings

Use the settings menu to adjust the various options for your Chromebook. To access the settings menu:

1. Click the status area in the lower-right corner, where your account picture appears.
2. Click on **Settings**.

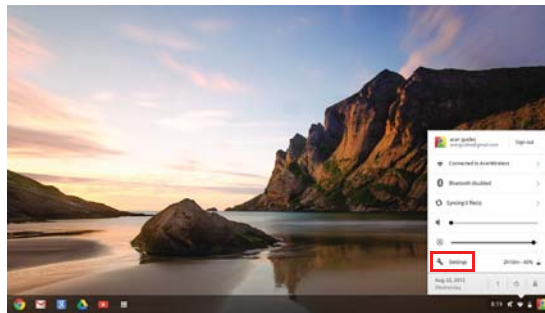

3. To show the advance settings, scroll to the bottom and click on **Show advanced settings**.

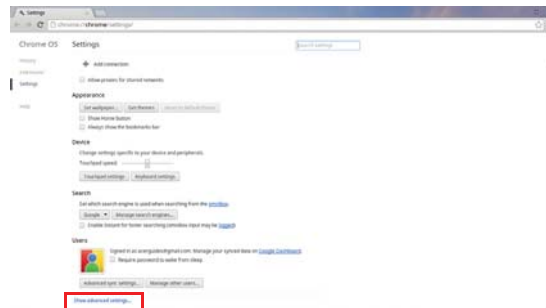

Changing the language settings

1. Click the status area in the lower-right corner, where your account picture appears.
2. Click on **Settings**.
3. Click on **Show advanced settings**.
4. Scroll down and click on **Customize languages and input**.
5. Click on **Add** to add additional languages.

6. To enable a language for keyboard input, select the checkbox next to the language after adding it.
7. Click on **OK** when finished.

Changing the clock settings

You are only able to change the time format and time zone on your Chromebook. If the date or time is incorrect on your Chromebook, try adjusting your time zone.

To change the time zone:

1. Click the status area in the lower-right corner, where your account picture appears.
2. Click on **Settings**.
3. Click on **Show advanced settings**.
4. Scroll down and click on the drop down box next to **Time zone**.

Customizing the appearance

Customizing the wallpaper

1. Click the status area in the lower-right corner, where your account picture appears.
2. Click on **Settings**.
3. Click on **Set wallpaper**.
4. Select a preloaded wallpaper or click **Browse** to select your own image. You can also choose **I'm feeling lucky** to have the wallpaper automatically change every time you sign in to your Chromebook.
5. Once selected, click **OK**.

Customizing the theme

1. Click the status area in the lower-right corner, where your account picture appears.
2. Click on **Settings**.
3. Click on **Get themes**.
4. You'll be taken to the Chrome Web Store, where you can find extra resources for the Chrome browser.
5. Once you find a theme that you'd like to try out, click **Choose theme**.

Setting up a printer

You can use the Google Cloud Print service to send print requests to your printer. Not all printers are supported.

To learn more about Google Cloud Print and how to set up your printer, connect to the Internet to access the more extensive online help from "**Online and offline help**" on **page 19** and then search for **Google Cloud Print**.

Updating Chrome OS

Automatic update

Each time you turn on your Chromebook, it automatically checks for updates. When an update is available, this update icon () will appear in the status area. To apply the update:

1. Click the status area in the lower-right corner, where your account picture appears.
2. Click **Restart to update**.
3. Your Chromebook will shutdown and automatically restart, with the update applied.

Manual update

To manually check for an update or check what version of Chrome OS you are using:

1. Click the status area in the lower-right corner, where your account picture appears.
2. Click on **Settings**.
3. In the new tab that opens, click on **Help** in the left column.
4. If any updates are available, they will be displayed on the page.



.....
Warning! Do not modify your Chromebook's hardware yourself. Doing so will cause the update function to no longer work. Please get in touch with your dealer or an authorized service center. Visit www.acer.com to find an authorized service site.

Help

Online and offline help

Additional help is available both online and offline. The help covers basic troubleshooting as well as more detailed information about Chrome OS.

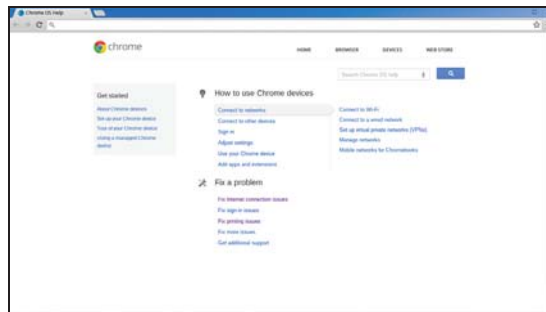

To access the help pages:

1. Click the status area in the lower-right corner, where your account picture appears.
2. Click on the question mark (?).



Note: If you are connected to the Internet, the more extensive online help will automatically open. Otherwise, the offline help will be opened.

Regulations and safety notices

FCC notice

This device has been tested and found to comply with the limits for a Class B digital device pursuant to Part 15 of the FCC rules. These limits are designed to provide reasonable protection against harmful interference in a residential installation. This device generates, uses, and can radiate radio frequency energy and, if not installed and used in accordance with the instructions, may cause harmful interference to radio communications.

However, there is no guarantee that interference will not occur in a particular installation. If this device does cause harmful interference to radio or television reception, which can be determined by turning the device off and on, the user is encouraged to try to correct the interference by one or more of the following measures:

- Reorient or relocate the receiving antenna.
- Increase the separation between the device and receiver.
- Connect the device into an outlet on a circuit different from that to which the receiver is connected.
- Consult the dealer or an experienced radio/television technician for help.

Notice: Shielded cables

All connections to other computing devices must be made using shielded cables to maintain compliance with FCC regulations.

Notice: Peripheral devices

Only peripherals (input/output devices, terminals, printers, etc.) certified to comply with the Class B limits may be attached to this equipment. Operation with non-certified peripherals is likely to result in interference to radio and TV reception.

Caution

Changes or modifications not expressly approved by the manufacturer could void the user's authority, which is granted by the Federal Communications Commission, to operate this computer.

Operation conditions

This device complies with Part 15 of the FCC Rules. Operation is subject to the following two conditions: (1) this device may not cause harmful interference, and (2) this device must accept any interference received, including interference that may cause undesired operation.

Notice: Canadian users

This Class B digital apparatus complies with Canadian ICES-003.

Remarque à l'intention des utilisateurs canadiens

Cet appareil numérique de la classe B est conforme à la norme NMB-003 du Canada.

Declaration of Conformity for EU countries

Hereby, Acer, declares that this notebook PC series is in compliance with the essential requirements and other relevant provisions of Directive 1999/5/EC.

Compliant with Russian regulatory certification



ME61

LCD pixel statement

The LCD unit is produced with high-precision manufacturing techniques. Nevertheless, some pixels may occasionally misfire or appear as black or red dots. This has no effect on the recorded image and does not constitute a malfunction.

Radio device regulatory notice



.....
Note: Below regulatory information is for models with wireless LAN and / or Bluetooth only.

General

To prevent radio interference to the licensed service, this device is intended to be operated indoors.

This product complies with the radio frequency and safety standards of any country or region in which it has been approved for wireless use. Depending on configurations, this product may or may not contain wireless radio devices (such as wireless LAN and/or Bluetooth modules). Below information is for products with such devices.

European Union (EU)

R&TTE Directive 1999/5/EC as attested by conformity with the following harmonized standard:

- Article 3.1(a) Health and Safety
 - EN60950-1
 - EN62311
- Article 3.1(b) EMC
 - EN301 489-1
- Article 3.2 Spectrum Usages
 - EN300 328
 - EN301 893 (Applicable to 5 GHz high performance RLAN)



List of applicable countries

EU member states as of July 2009 are: Belgium, Denmark, Germany, Greece, Spain, France, Ireland, Italy, Luxembourg, the Netherlands, Austria, Portugal, Finland, Sweden, United Kingdom, Estonia, Latvia, Lithuania, Poland, Hungary, Czech Republic, Slovak Republic, Slovenia, Cyprus, Malta, Bulgaria and Romania. Usage is allowed in the countries of European Union, as well as Norway, Switzerland, Iceland and Liechtenstein. This device must be used in strict accordance with the regulations and constraints in the country of use. For further information, please contact local office in the country of use. Please see ec.europa.eu/enterprise/rtte/implem.htm for the latest country list.

The FCC RF safety requirement

The radiated output power of the wireless LAN Mini PCI Card and Bluetooth card is far below the FCC radio frequency exposure limits. Nevertheless, the notebook PC series shall be used in such a manner that the potential for human contact during normal operation is minimized as follows:

1. This device is restricted to indoor use due to its operation in the 5.15 to 5.25 GHz frequency range. FCC requires this product to be used indoors for the frequency range 5.15 to 5.25 GHz to reduce the potential for harmful interference to co-channel Mobile Satellite systems.
2. High power radar is allocated as the primary user of the 5.25 to 5.35 GHz and 5.65 to 5.85 GHz bands. These radar stations can cause interference with and/or damage this device.
3. An improper installation or unauthorized use may cause harmful interference to radio communications. Also any tampering of the internal antenna will void the FCC certification and your warranty.

Canada — Low-power license-exempt radio communication devices (RSS-210)

Exposure of humans to RF fields (RSS-102)

The computer employs low gain integral antennas that do not emit RF field in excess of Health Canada limits for the general population; consult Safety Code 6, obtainable from Health Canada's website at www.hc-sc.gc.ca/rpb. This device complies with RSS210 of Industry Canada.

This Class B digital apparatus complies with Canadian ICES-003, Issue 4, and RSS-210, No 4 (Dec 2000) and No 5 (Nov 2001).

"To prevent radio interference to the licensed service, this device is intended to be operated indoors and away from windows to provide maximum shielding. Equipment (or its transmit antenna) that is installed outdoors is subject to licensing." Cet appareil numérique de la classe B est conforme à la norme NMB-003, No. 4, et CNR-210, No 4 (Dec 2000) et No 5 (Nov 2001).

« Pour empêcher que cet appareil cause du brouillage au service faisant l'objet d'une licence, il doit être utilisé à l'intérieur et devrait être placé loin des fenêtres afin de fournir un écran de blindage maximal. Si le matériel (ou son antenne d'émission) est installé à l'extérieur, il doit faire l'objet d'une licence.

Caution: When using IEEE 802.11a wireless LAN, this product is restricted to indoor use due to its operation in the 5.15- to 5.25-GHz frequency range. Industry Canada requires this product to be used indoors for the frequency range of 5.15 GHz to 5.25 GHz to reduce the potential for harmful interference to co-channel mobile satellite systems. High power radar is allocated as the primary user of the 5.25 to 5.35 GHz and 5.65 to 5.85-GHz bands. These radar stations can cause interference with and/or damage to this device.

The maximum allowed antenna gain for use with this device is 6 dBi in order to comply with the E.I.R.P limit for the 5.25 to 5.35 and 5.725 to 5.85 GHz frequency range in point-to-point operation.