

Comfort Digisystem User manual



Comfort Digisystem

Receiver

DT10

&

Programmer DT05

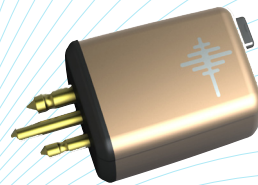

US / English



Comfort Audio
HEAR THE FUTURE

User manual

Table of contents	Page
1) Regulatory information	3
2) Introduction Comfort Digisystem	4
3) Overview - Receiver DT10	4
4) Check the hearing instruments input	4
5) Getting started	5
6) Acoustic indication, sound signals	5
7) Modes in the Receiver DT10	6
8) Output for user with different input types and programs in the hearing instrument	6
9) Pairing	8
10) Functions Programmer DT05 - professional tool	9
11) Included accessories	9
12) Menu Programmer DT05	10
13) Battery maintenance Programmer DT05	11
14) Technical data Receiver DT10	11
15) Trouble shooting	12
16) Service and warranty	12
17) Radio range and channels	13
18) Important safety instructions	13

1) Regulatory information

Comfort Digisystem products are not to be used as a substitute to the hearing aids and should be used in accordance with the specifications and recommendations provided by your physician.

NOTE! Max output > 130 dB SPL (Sound Pressure Level). Could be very dangerous for your hearing. It is recommended that customers keep the volume control in the lowest position, when turning on the device. If not, the sound could potentially cause harm to the customers' hearing.

Comfort Audio is not liable for damages arising from usage of the equipment not in accordance with the instructions provided by Comfort Audio. Comfort Audio shall not be liable for performance problems and/or damages caused in any way by customer's modification of any part of the equipment.

Federal Communications Commission Statement, This device complies with part 15 of the FCC Rules. Operation is subject to the following two conditions:

- (1) this device may not cause harmful interference, and
- (2) this device must accept any interference received, including interference that may cause undesired operation.

Programmer DT05 - FCC ID: UOJ-DG04T

Industry Canada,

This device complies with Industry Canada licence-exempt RSS standard(s). Operation is subject to the following two conditions:

- (1) this device may not cause interference, and
- (2) this device must accept any interference, including interference that may cause undesired operation of the device.

Le présent appareil est conforme aux CNR d'Industrie Canada applicables aux appareils radio exempts de licence.

L'exploitation est autorisée aux deux conditions suivantes :
(1) l'appareil ne doit pas produire de brouillage, et
(2) l'utilisateur de l'appareil doit accepter tout brouillage radioélectrique subi, même si le brouillage est susceptible d'en compromettre le fonctionnement.

Model: DT05
IC: 6769A-DG04T

Model: DT10
IC: 6769-DG02R

ETL

Conforms to UL Standard for Safety for Audio, Video and Similar electronic apparatus – Safety Requirements UL 60065, Issue:2003/06/30 Ed:7 Rev:2007/12/11

Certified to CSA Standard for Safety for Audio, Video and Similar electronic apparatus – Safety Requirements CAN/CSA-C22.2 No. 60065:03, Issued 2003/04/01 Ed:1 Amendment 1:2006

Intertek ETL Control number: 4002355

WARNING!

Changes or modifications not expressly approved by the party responsible for compliance could void the user's authority to operate the equipment.

NOTE:

This equipment has been tested and found to comply with the limits for a Class B digital device, pursuant to Part 15 of the FCC Rules. These limits are designed to provide reasonable protection against harmful interference in a residential installation. This equipment generates, uses and can radiate radio frequency energy and, if not installed and used in accordance with the instructions, may cause harmful interference to radio communications. However, there is no guarantee that interference will not occur in a particular installation. If this equipment does cause harmful interference to radio or television reception, which can be determined by turning the equipment off and on, the user is encouraged to try to correct the interference by one or more of the following measures:

- Reorient or relocate the receiving antenna.
- Increase the separation between the equipment and receiver.
- Connect the equipment into an outlet on a circuit different from that to which the receiver is connected.
- Consult the dealer or an experienced radio/TV technician for help.



DANGER!

DO NOT USE the **COMFORT DIGISYSTEM** products if you have a **PACEMAKER** or other implanted device. The Comfort Digisystem products could cause the pacemaker or other implanted device to malfunction and cause serious injury or death.

2) Introduction to the Comfort Digisystem

Thank you for choosing Comfort Digisystem. Our products are easy to use and give you crystal clear sound. Before using the product, please read this manual carefully. The Comfort Digisystem products feature SecureStream Technology – a unique, patented digital technology allowing eavesdrop-secure radio transfer in real time.

Comfort Digisystem Receiver DT10 — the world's first digital mini receiver

The Comfort Digisystem Receiver DT10 is a digital mini receiver that you can easily connect to any hearing aid with a standard three-pin Europlug audio shoe. The receiver weighs 0,05 oz (1,5 g) and is powered by the hearing instrument's battery. To minimize energy consumption, the mini receiver is equipped with an optional auto-sleep feature.

Together with existing microphones and receivers in the Comfort Digisystem assortment, the Receiver DT10 provides clear speech perception. The Receiver DT10 is the world's first mini receiver, taking full advantage of digital technology in enabling outstanding sound reproduction.

The optional professional tool Programmer DT05 can be used to configure the Receiver DT10. The Programmer DT05 also makes it easy to test the Receiver DT10 with or without a hearing instrument.

3) Overview - Receiver DT10

Europlug

For connecting to the audio shoe on a hearing instrument or to the socket on the Programmer DT05.

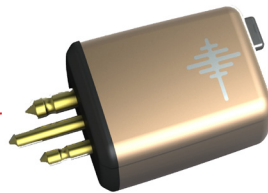

Push-button

For toggling between different listening modes and activating pairing mode.

4) Check the hearing instruments input

To be able to use the Receiver DT10, check if — and how — the hearing instrument supports the use of a mini receiver:

1. The hearing instrument must be equipped with an **audio shoe with a powered Europlug socket** made for mini receiver use. This connects the Receiver DT10 to the hearing instrument and also supplies the DT10 with power from the hearing instrument's battery. The received audio signal will then be transferred from the Receiver DT10 to the hearing instrument through the audio shoe.

2a. If the hearing instrument is equipped with a **Programmable DAI input (DPAI)**, programming of the hearing instrument might be necessary (check with audiologist or hearing instrument manufacturer). In this case the push-button on the Receiver DT10 cannot switch between the R and R+M modes. This is instead done by using different listening programs in the hearing instrument.

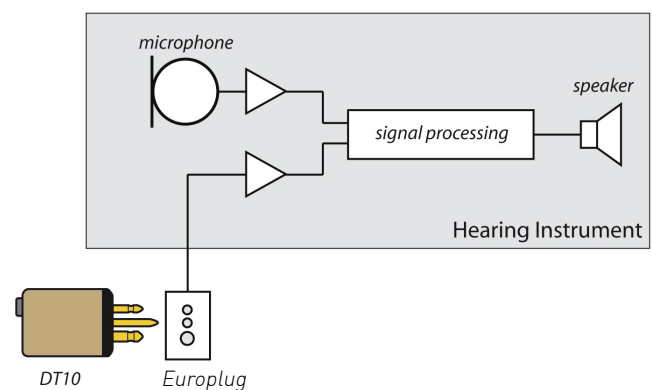

TIP! The volume of the Receiver DT10's R and R+M mode can be set individually by using the Programmer DT05. This makes it possible to use the push-button as a simple volume control in combination with a hearing instrument with Programmable DAI input (DPAI).

2b. If the hearing instrument is equipped with a **DAI input** (check with audiologist or hearing instrument manufacturer), no programming of the hearing instrument is necessary. The Receiver DT10 works with the Microphone (M) listening program on your hearing instrument. By setting up the Receiver DT10 with the Programmer DT05, the push-button on the Receiver DT10 can be used to select the listening mode: Radio only (R mode) or Radio + Hearing instrument microphone (R+M mode).

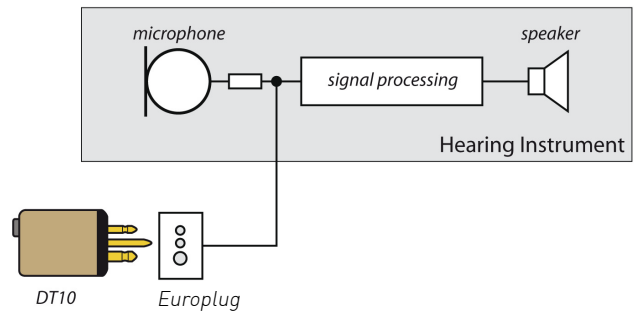

5) Getting started

Connect the Receiver DT10 to the audio shoe on the hearing instrument.
Check that the audio shoe is connected to the hearing instrument according to the manufacturer's instructions.

Make sure that the Receiver DT10 is fitted in the correct manner and push the Euro-plug completely into the socket of the audio shoe.

The Receiver DT10 is powered by the hearing instrument's battery. Make sure that the battery is fresh. If you are unsure, replace the battery.

Briefly press the push-button on the Receiver DT10 to turn it on or off.
(If the Receiver DT10 has been programmed to the mode *Always on*, it will start automatically when it's connected to the hearing instrument. The on/off function of the push-button is then disabled.)

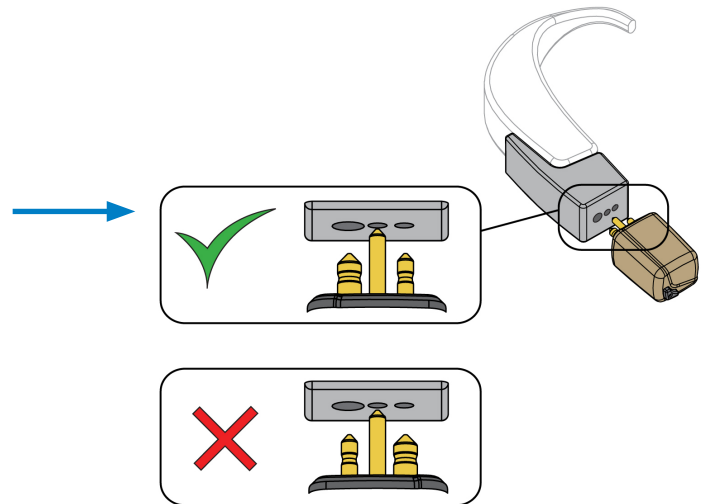

6) Acoustic indication, sound signals

The following is a description of the acoustic indications (sound signals). The sound signals consist of various combinations of two different tones: one high pitch tone (1000 Hz) and one low pitch tone (500 Hz), and two different tone lengths.

Action:	Sound signal:	Indicate this:
Button pressed briefly	Short high pitch	Selecting mode or turning on
Button pressed briefly	Short high pitch x 2 + long low pitch	Turning off
Button pressed 2 sec.	Short low pitch + short high pitch	Pairing mode
Pairing	Short high pitch x 2	Successful pairing
Pairing	Long high pitch + long low pitch	Pairing failed

7) Listening modes in the Receiver DT10

The available listening modes in the Receiver DT10 can be setup in different configurations:

R	Default setting
R+M	Setup with Programmer DT05 is necessary
R and R+M	Setup with Programmer DT05 is necessary

The Programmer DT05 is used to configure and enable or disable different listening modes in the Receiver DT10. The push-button on the Receiver DT10 is used to toggle between the activated listening modes.

It is also possible to disable the push-button completely.

8) Output for user with different input types and programs in the hearing instrument

Different hearing instrument electrical input types and available programs in the hearing instrument will result in different output for the user. Output for the user is shown in the white sections of the charts below.

Receiver DT10 with R mode enabled (default setting)

The chart below shows the output (what the user can hear) when Receiver DT10 listening mode R is enabled in combination with different input types and programs in the HI.

When pressing the push button on the Receiver DT10, the listening mode is shifted in the following sequence:

Hearing instrument:	Receiver DT10 push-button	
	Off	R mode
DAI input	Off	Radio only
Programmable DAI input (DPAI) DAI + M program	Off	Radio + HI microphone
Programmable DAI input (DPAI) DAI program only	Off	Radio only

Receiver DT10 with R+M mode enabled and R mode disabled

The chart below shows the output (what the user can hear) when Receiver DT10 listening mode R+M is enabled, in combination with different input types and programs in the HI.

When pressing the push-button on the Receiver DT10, the listening mode is shifted in the following sequence:

Hearing instrument:	Receiver DT10 push-button	
	Off	R+M mode
DAI input	Off	Radio + HI microphone
Programmable DAI input (DPAI) DAI + M program	Off	Radio + HI microphone
Programmable DAI input (DPAI) DAI program only	Off	Radio only

Receiver DT10 with both R and R+M modes enabled

The chart below shows the output (what the user can hear) when Receiver DT10 listening modes R and R+M both are enabled, in combination with different input types and programs in the HI.

When pressing the push-button on the Receiver DT10, the listening mode is shifted in the following sequence:

Hearing instrument:	Receiver DT10 push-button		
	Off	R mode	R+M mode
DAI input	Off	Radio only	Radio + HI microphone
Programmable DAI input (DPAI) DAI + M program	Off	Radio + HI microphone *	Radio + HI microphone *
Programmable DAI input (DPAI) DAI program only	Off	Radio only *	Radio only *

* When using this setup in combination with Programmable DAI input (DPAI), the level of the two modes (R+M and R) can be programmed individually to serve as a volume control.

Note! Difference in volume can occur

When using a hearing aid with Programmable DAI input (DPAI) and having both R and R+M modes in the Receiver DT10 enabled there can be a difference in volume between the R and R+M modes even if the Receiver DT10 has been programmed with identical output levels for the two modes. The reason for this difference is that the output level in the Receiver DT10 is affected by the input impedance of the hearing instrument.

The difference in output level can vary between different hearing instruments - usually the output level will be slightly higher in the R+M mode. An adjustment might be done with the Programmer DT05 in order to meet the users requirements.

9) Pairing

The Receiver DT10 can receive but not transmit pairing information. To pair the Receiver DT10 with your Comfort Digisystem transmitter the Receiver DT10 must be connected either to your hearing instrument or to the Programmer DT05.



Press the push-button on the Receiver DT10 for 2 seconds to activate pairing mode.

When pairing mode is activated, you receive an acoustic indication: 



Send the pairing information within 15 seconds.

To interrupt pairing mode, briefly press the push-button.





Example 1: Pairing a Receiver DT10 into an existing Comfort Digisystem consisting of one Conference Microphone DC10 and one Receiver DH10:

1. Connect the Receiver DT10 to the hearing instrument's audio shoe according to the instructions.
2. Initiate pairing mode in the DT10 by pressing the push-button for 2 seconds.
Acoustic indication: 
3. Start the Conference Microphone DC10.
4. Rapidly press the pairing button on the DC10 twice. The display on the DC10 responds with the text "Info sent".
5. The Receiver DT10 confirms successful pairing with an acoustic indication: 

Example 2: Make a new eavesdrop secure configuration with one Microphone DM10 and two hearing instruments with Receiver DT10s:

1. Connect the Receiver DT10s to the hearing instrument's audio shoes according to the instructions.
2. Activate pairing mode in the two DT10's by pressing the push-buttons for 2 seconds.
Acoustic indication: 
3. Start the Microphone DM10 and open the menu. Select *Communication/Pairing/New code key* and answer *Yes* if you want to create a new code key and transmit it.
4. The Receiver DT10s confirm successful pairing with an acoustic indication: 

Example 3: Make a new eavesdrop secure configuration with one Microphone DM10 and two Receiver DT10s using the Programmer DT05:

1. Put one of the Receiver DT10s into the Programmer DT05.
2. Start the Programmer DT05 and connect headphones or a neck loop to be able to listen.
3. Activate pairing mode for the DT10 by pressing the push-button for 2 seconds.
In the headphones/neckloop you receive an acoustic indication: 
4. Start the Microphone DM10 and open the menu. Select *Communication/Pairing/New code key* and answer *Yes* if you want to create a new code key and transmit it.
5. The Receiver DT10 confirms successful pairing with an acoustic indication: 
6. Remove the paired DT10 and connect the other DT10 into the Programmer DT05.
7. Activate pairing mode on the DT10 by pressing the push-button for 2 seconds.
In the headphones/neckloop you receive an acoustic indication: 
8. Open the menu on the DM10 and select *Communication/Pairing/Send info*.
9. The Receiver DT10 confirms successful pairing with an acoustic indication: 

INFORMATION FOR PROFESSIONALS:

10) Functions Programmer DT05 - optional professional tool

Order separately



11) Included accessories

- Headphones
- Charger A11

Volume indicator



Europlug socket

Programmer DT05

The Programmer DT05 is an optional professional tool that can be used both for configuring and test-listening of the DT10.

The Programmer DT05 can be used to configure one setting at a time in the Receiver DT10. Select the desired setting in the menu and double press the pairing button. The Receiver DT10 must be set to pairing mode.

The Programmer DT05 can also be used to configure all settings at the same time in a DT10. To do this, adjust all parameters in the DT05 and then select *Send all* on the DT05 menu. The Receiver DT10 must be set to pairing mode.

When using the Programmer DT05 for configuring the distance between the Programmer DT05 and the Receiver DT10 should not exceed 0.5 meters.

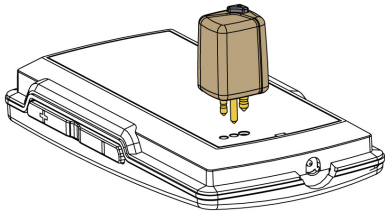

To listen to a DT10, plug it into the socket on the programmer and connect headphones or a neck-loop.

Menu control



To access the menu, press the menu control and then scroll up or down.

Press the menu control to select.

12) Menu in the Programmer DT05

R enable

R

R+M enable

R+M

Tone ind.

Auto sleep

Pairing

Always on

Send all

Settings

- *Language*

- *Factory Reset*

About

Back (relates to both the main menu and submenus)
Here you can choose to return to the menu and to the main display.

R enable

Enables selection of R mode with the push-button.

R

Adjusts the output level of the Receiver DT10 when using R mode.

R+M enable

Enables selection of R+M mode with the push-button.

R+M

Adjusts the output level of the Receiver DT10 when using R+M mode.

Tone ind.

Activates acoustic indication tones when selected. Indication for pairing mode and pairing is always heard even if *Tone ind.* is disabled.

Auto sleep

When *Auto sleep* is enabled the Receiver DT10 goes into sleep mode if the Digisystem Microphone (transmitter), is turned off. This significantly reduces the power consumption of the Receiver DT10. The Receiver DT10 automatically starts again when you turn on your microphone.

Warning! If the Receiver DT10 is in sleep mode and another radio signal (with the same frequency that you are using) is present, the Receiver DT10 might start again automatically. This could cause a loud hissing noise and that's why *Auto sleep* should be used with caution.

Pairing

When *Pairing* is selected, the DT10 can be set to pairing mode by pressing the push-button for two seconds. If *Pairing* isn't selected, pairing mode cannot be enabled with the push-button. To override this, (if the Receiver DT10 needs to be reconfigured or if new pairing information needs to be received), press and hold the push-button on the Receiver DT10 for 2 seconds **within** 10 seconds of it having been connected to a hearing instrument or a Programmer DT05. This sets the Receiver DT10 to Pairing mode and it is then ready to receive new settings from the Programmer DT05.

Always on

The setting *Always on*, disables the off-function of the push-button, leaving the Receiver DT10 always on.

If you enable *Always on* and at the same time disable *Pairing*, the push-button on the Receiver DT10 becomes inoperable.

Send all

To configure a Receiver DT10 with all settings in the display of the Programmer DT05 select *Send all*. If you choose *Send all*, you will receive the warning "All settings in DT10 will be overwritten". Only select *Yes* if you want to overwrite all data in your Receiver DT10.

Settings

Language

For selection of menu language.

Factory Reset

DT05: Resets the Programmer DT05 to its default settings.

DT10: Resets the Receiver DT10 to its default settings. Also deletes all pairing information.

To prevent eaves-dropping a new code key must be generated.

About

Software information.

13) Battery maintenance Programmer DT05

The rechargeable products in the Digisystem series are equipped with Li-Pol batteries, ie. the same type of batteries used for most mobile phones and laptop computers on the market today. These types of batteries are able to store large amount of energy in relation to their weight and volume.

The capacity of Li-Pol batteries diminishes during its life cycle. The battery type has no "memory effect", which would mean that you need fully discharge the battery before charging to minimize capacity loss. This means that you can just as well charge the battery often and little, as opposed to seldom and much. Special charging circuits in the Digisystem products protect batteries from overcharging.

The capacity of the Li-Pol batteries deteriorates faster when they subjected to deep discharge. Therefore, all products of the Digisystem are fitted with a function that automatically turns off the product well before deep discharge occurs. Deep discharge may still happen as the battery has a certain self-discharge. A product that is fully or partly charged will with enough time reach a state when the battery deep discharges, unless the charger is connected. To avoid this we recommend that the battery is charged at least every 6 months.

Please note:

Only use the charger supplied by Comfort Audio. Changing the battery without the assistance of an authorized dealer will void the Limited Warranty.

14) Technical data Receiver DT10

Radio transmission:	SST - SecureStream Technology
Frequency range:	904 - 927 MHz
Range:	Approx. 50 feet (15 m)
Dimensions:	0,38 x 0,44 x 0,84 inches (9,7 x 11,2 x 21,3 mm)
Weight:	0,05 oz (1,5 g)



Conforms to ANSI/UL Std.60065

Certified to CAN/CSA Std.C22.2 No.60065:03

Intertek
4002355

The weights, dimensions, capacities, performance ratings and other data in Comfort Audio's brochures, prospectus, circulars, advertisements, price lists and instructions sheets are mentioned only as general information. They are only approximate and shall not bind Comfort Audio.

15) Trouble shooting

The receiver does not start

1. Check that the correct listening program is selected on the hearing instrument.
2. Make sure the Receiver DT10 is correctly connected to the hearing instrument's audio shoe. Also check the connection between the audio shoe and the hearing instrument.
3. Make sure all connecting surfaces are clean.
4. Check/replace the hearing instrument's battery.
5. Remember to press the push-button briefly to switch the DT10 on.

Poor speech intelligibility

The distance between the transmitter and the receiver may be too long. The range is around 50 feet (15 meters).

The distance between the microphone and the talking person may also be too long; move the microphone closer to the talking person.

Try changing the channel/environment.

Poor range and interference

In some environments, such as in buildings with a lot of concrete, iron or sheer metal structures, the range may be reduced.

There may also be electronic equipment nearby causing interference. Change the channel.

No sound

Check that the transmitter and the receiver are set to the same channel.

Loud hissing noise

Check that the Comfort Digisystem units you are using are paired together.

If *Auto sleep* is enabled, the Receiver DT10 goes into sleep mode if there is no radio signal. But if another radio signal (with the same frequency you are using) is present, the Receiver DT10 might start again automatically. This could cause a loud hissing noise and that's why *Auto sleep* should be used with caution.

16) Service and warranty

Warranty extension

Comfort Audio Inc. warrants this product sold to the first end user (buyer) against defects in materials or workmanship for the time period and as set forth below. Pursuant to this Limited Warranty, Comfort Audio will, at its own option, either (a) repair the product or the parts determined to be defective, using new or refurbished parts, or (b) provide you with a new, or at our option, a refurbished unit. The repaired or exchanged unit is under warranty for the remainder of the original product's warranty period. The warranty does not include any other direct, indirect or consequential damage or loss, or any third party damages or losses.

This Limited Warranty is for a period of two years from the date of purchase as indicated by an original receipt from a Comfort Audio authorized retailer, dispenser or medical facility. Headphones and earphones have a warranty of 30 days from purchase.

How to make a warranty claim

For warranty service, you must contact the Comfort Audio Customer Service listed below to obtain an RMA (Return Merchandise Authorization) number. A description of the defect, your name, address and telephone number is required.

Ship the product freight prepaid via UPS or its equivalent, including a copy of the original purchase receipt, any cables, earphones and base/charger unit, in its original packaging or one that offers equal protection. Insure your shipment for loss or damage. Comfort Audio accepts no liability in case of damage or loss en route to our offices.

This Limited Warranty does not cover

Damage from misuse, neglect or normal wear and tear. Products that have been modified. Products purchased or serviced outside the territory. If you purchased your product outside the territory, see your retailer for warranty information.

Product Registration

Please complete, sign and mail the Product Registration Card packed with your unit. It will make it easier to contact you if it ever would be necessary.

Comfort Audio Inc.
350 South Northwest Hwy, Ste 300
Park Ridge, IL 60068 USA

To contact the Comfort Audio Customer Service,
call (847) 656 5450
or by e-mail usa@comfortaudio.com

17) Radio range and channels

The transmitter and receiver have built-in antennas. The radio range between the units varies depending on the product and the particular environment you are in.

Like all radio systems, Comfort Digisystem communicates on specific channels. If you use two transmitters on the same channel or a neighbouring one, there may be interference. Other electronic equipment can also interfere with radio transmissions.

The channel that you use in your country is perhaps not permitted abroad. Always get in touch with your hearing aid provider in your country in order to find out which channels are permitted in different countries.

Comfort Audio is not liable for unauthorized use of radio waves, such as, but not limited to: interferences with police communication, or strategic communication, military installations etc.

18) Important safety instructions - Read these before using your product

Not following the Important Safety Instructions, or trying to repair and/or tampering the Equipment without the assistance of an authorized technician will void the Limited Warranty. Comfort Audio is not liable for any damages arising out of such unauthorized uses, repairs, and/or tampering.

Please, heed all warnings. Read, keep and follow all the safety instructions below.

WARNING!

- Too high a volume can seriously damage your hearing.
- The necklace should not be used if there is a risk of getting stuck, e.g. in a machine or other objects.
- Keep small parts out of reach of children and animals. Choking hazard if swallowed.
- There is a danger of explosion if the battery is incorrectly replaced.

Follow these instructions:

- 1) Do not use this product near water or in moist environments of any kind.
- 2) The product shall not be exposed to excessive heat such as sunshine, fire or the like.
- 3) Do not use the product near any heat sources such as radiators, heat registers or other apparatus that produce heat (e.g. amplifiers) and do not leave products, e.g. in a warm car.
- 4) Do not disassemble the product.

- 5) You must not change the battery yourself; please contact your point of purchase.
- 6) Do not defeat the safety features of the polarized or grounded plug. A polarized plug has two blades with different widths and will only fit into the socket one way. A grounded plug has a third grounded prong. The asymmetrical blades and the grounded prong are there for your safety. If the provided plug does not fit into your outlet, please consult a qualified professional/electrician for replacement of your outlet.
- 7) Never use a transmitter or receiver set to a non-permitted frequency. Check with the frequency authority in the country where the equipment is to be used.
- 8) The products include radio transmitters. Do not use products where it is not allowed to use electronic equipment, e.g. on airplanes.
- 9) Never charge product in closed, unaired spaces such as handbags, cases or other closed storage bags.
- 10) Ensure that the power cord is not pinched or damaged in any other way.
- 11) Unplug the product during lightning storms or if it is not used for a long period of time.
- 12) Always start listening at a low volume and then adjust it to a comfortable level.
- 13) Clean only with a dry cloth.
- 14) Only use the batteries and power supply or other accessories specified by Comfort Audio.
- 15) The product contains sensitive electronic equipment and must be handled carefully.
- 16) If the product does not operate normally, or if it has been damaged in any way, service is required. E.g. if the power-supply cord or plug is damaged, if the product has been in contact with water or if the product has been exposed to external impact, for instance been dropped. Refer all servicing to authorized service personnel.
- 17) Should the product break open because of damage, service should only be done by qualified service personnel.

Subject to change



Comfort Audio
HEAR THE FUTURE

Manufactured by:

Comfort Audio AB

Comfort Audio AB, Box154, SE-301 05 Halmstad, Sweden
Tel. +46 (0)35 260 16 00 Fax +46 (0)35 260 16 50

Local US office:

Comfort Audio Inc, 350 South Northwest Hwy, Ste 300
Park Ridge, IL 60068 USA
T (847) 656 5450
usa@comfortaudio.com www.comfortaudio.us