

hp deskjet 9300 series printer

user's guide

Notice

The information contained in this document is subject to change without notice.

Hewlett-Packard makes no warranty of any kind with respect to this information. HEWLETT-PACKARD SPECIFICALLY DISCLAIMS THE IMPLIED WARRANTY OF MERCHANTABILITY AND FITNESS FOR A PARTICULAR PURPOSE.

Hewlett-Packard shall not be liable for errors contained herein or for incidental or consequential damages in connection with the furnishing, performance, or use of this material.

No part of this document may be photocopied, reproduced, or translated to another language without the prior written consent of Hewlett-Packard Company.

Copyright Information

© Copyright Hewlett-Packard Company 2003.

All Rights Reserved.

First Edition: May, 2003

Acknowledgements

HP ColorSmart II and HP PhotoREt III are trademarks of Hewlett-Packard Company.

Microsoft®, Windows®, Windows NT®, and MS-DOS® are U.S.-registered trademarks of Microsoft Corporation.

Safety Information



Always follow basic safety precautions when using this product to reduce risk of injury from fire or electric shock.

- 1 Read and understand all instructions in the documentation that comes with the printer.
- 2 Observe all warnings and instructions marked on the product.
- 3 Unplug this product from wall outlets before cleaning.
- 4 Do not install or use this product near water, or when you are wet.
- 5 Install the product securely on a stable surface.
- 6 Install the product in a protected location where no one can step on or trip over the line cord, and the line cord cannot be damaged.
- 7 If the product does not operate normally, see ["Troubleshooting."](#)
- 8 There are no user-serviceable parts inside. Refer servicing to qualified service personnel.

Contents

Welcome

Using this guide	1-1
For more information	1-1

Printer basics and connections

Understanding the printer parts and functions	2-1
Connecting the printer	2-2
For Windows	2-2
For Macintosh	2-3
Using the printer on a network	2-4
For Windows	2-4
Changing print settings	2-6
Using the print cartridges	2-6
Replacing the print cartridges	2-6
Aligning the print cartridges	2-7
Cleaning the print cartridges	2-7
Printing from MS-DOS software programs	2-8

Printing and loading media

Loading paper	3-1
Main paper tray	3-1
Rear manual feed	3-2
Minimum printing margins	3-3
Printing on various paper types and sizes	3-3
Printing on transparencies	3-3
Printing on HP media	3-4
Printing on standard-sized paper	3-5
Printing on custom-sized paper	3-5
Printing on envelopes	3-6
Printing on cards	3-6
Printing on thick plain paper or photo paper	3-7
Printing on both sides of the paper	3-8
For Windows	3-8
For Macintosh	3-9
Understanding smart software features	3-9

Using the Toolbox

Printer Status tab	4-1
Information tab	4-1
hp instant support	4-2
myPrintMileage	4-2
Ordering printing supplies directly through the Toolbox	4-3
Printer Services tab	4-3
Using the HP Inkjet Utility (Macintosh)	4-3
Displaying the HP Inkjet Utility	4-3
Viewing the HP Inkjet Utility panels	4-4

Troubleshooting

Power cannot be turned on	5-1
Printer is not responding (nothing prints)	5-1
Paper feed problem	5-2
Paper skew problem	5-3
Paper is jammed in the printer	5-3
Tips for avoiding paper jams	5-3
A blank page is ejected	5-3
Poor print quality	5-4
Printout is faded or colors are dull	5-4
Colors are bleeding into each other	5-4
Ink is smearing onto white (blank) areas	5-5
Ink is not filling the text or graphics completely	5-5
Text is jagged at the edges (not smooth)	5-5
Something on the page is missing or incorrect	5-6
Unexpected results	5-6
Text or graphics are cut off at page edges	5-6
Placement of the text or graphics is incorrect	5-7
Meaningless characters are printed	5-7
Wrong fonts are printed	5-7
Colors are different than they should be	5-8
Slow printing	5-8
Printer lights blink	5-9
Network printing problem	5-10
Uninstalling the printer software	5-10
USB installation failed or nothing prints through USB	5-11
Printer does not print after switching ports	5-11
Print cartridge problem	5-12
Printing a sample page	5-13
Printing a diagnostic page	5-13
Cancelling a print job	5-13

Customer Support

Printer specifications

HP supplies and accessories

Regulatory information

Hewlett-Packard Limited Warranty Statement

Index

1

Welcome

Your printer can print vibrant colors on paper up to 330 by 483 mm (13 by 19 inches). It connects directly to computers that have parallel or Universal Serial Bus (USB) ports. The printer can also be shared on a network.

Using this guide

This guide includes the following sections:

- **Printer basics and connections** – Describes the printer parts and explains how to connect using a USB or a parallel cable, how to connect to a network, and how to connect to an external print server. Also explains how to use the print cartridges.
- **Printing and loading media** – Illustrates how to load print media and explains how to print on various paper types and sizes.
- **Using the Toolbox** – Describes the features of the Toolbox, such as ink level information, print cartridge maintenance, and links to the onscreen user's guide (which contains "how-to" and troubleshooting instructions) and the myPrintMileage website (which keeps track of printer usage information).
- **Troubleshooting** – Helps you solve printer problems and explains how to contact Customer Support.
- **Customer Support** – Lists support services to obtain assistance for your printer.
- **Printer specifications and HP supplies** – Lists information such as print cartridge part numbers, supported media, tray capacity, and system requirements.

For more information

- **Toolbox** – Contains "how-to" and troubleshooting instructions and allows access to printer maintenance functions and HP information.
- **Starter CD** – Includes printer software, additional software templates, a utility that lets you copy the printer software to a floppy disk, an electronic copy of this user's guide, and ordering information.
- **Website** – <http://www.hp.com/support/dj9300> links to the HP Support website for the latest printer software, product, operating system, and support information.
- **hp instant support** – A web-based tool that provides product-specific services, troubleshooting tips, and information about your printer's ink and media usage. This e-service can be accessed via the Toolbox.



If the suggestions in these resources do not help you solve your printing problems, see "[Troubleshooting](#)" for a list of resources available to you for the support and maintenance of your printer. Or, ask for assistance from your local HP Customer Care Center.

2

Printer basics and connections

Understanding the printer parts and functions

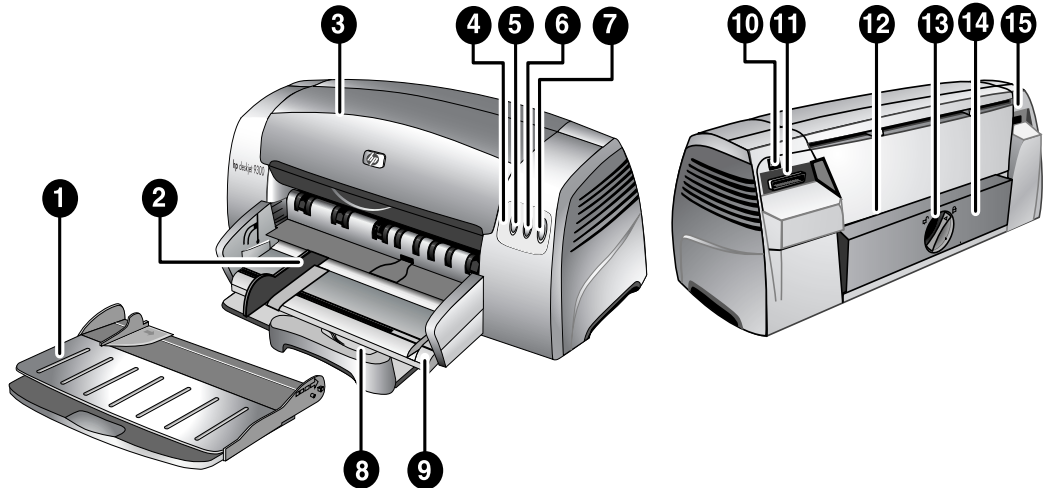

- 1 Output tray** – Collects the printed pages.
- 2 Paper guides** – Guides the paper into the printer.
- 3 Access cover** – Lets you access the print cartridges and jammed paper.
- 4 Print Cartridge light** – Blinks when the access cover is open or a cartridge error occurs.
- 5 Cancel button** – Cancels the current print job.
- 6 Resume button** – Blinks while waiting for a printed page to dry. Press if you do not want to wait.
- 7 Power button** – Turns the power off and on.
- 8 Postcard guide** – Extends to guide short media into the printer.
- 9 Main paper tray** – Holds up to 150 sheets of standard paper or 30 transparencies.
- 10 USB port** – Connector for the Universal Serial Bus cable.
- 11 Parallel port** – Connector for the parallel cable.
- 12 Rear manual feed** – Feeds thicker paper that requires a straight paper path.
- 13 Removable panel knob** – Turns counterclockwise to remove the rear panel, or clockwise to lock it.
- 14 Removable panel** – Lets you access jammed paper.
- 15 Power input** – Connector for the power cable.

Connecting the printer

Your printer supports local printing and network printing. For local printing, you can connect the printer using a USB cable or parallel cable. For network printing, you can connect via an optional HP external print server.



It is recommended that you install the software before you connect the printer to the computer.

For Windows

Use a USB cable to connect the printer to the computer if the computer has a USB port and is running Windows 98, Windows Me, Windows 2000, or Windows XP.

If your computer does not meet these specifications, connect the printer to your computer using a parallel cable.

In most cases, after you install the printer software and connect a printer to the computer, you can install additional printers with USB cables without reinstalling the printing software.

Software-first installation (recommended)

- 1 Start Windows and make sure no other Windows applications are running.
- 2 Insert the Starter CD into the CD-ROM drive. The CD menu runs automatically. If the CD menu does not run automatically, click **Start**, click **Run**, and in the command line box type the letter of your computer's CD-ROM drive followed by `: \setup` (for example, type `D: \setup`).
- 3 Click **Install Printer Driver** from the CD menu.
- 4 Choose your language and click **OK**.
- 5 Follow the onscreen instructions.
- 6 Click **Connected directly to this computer**, and then click **Next**.
- 7 If you are using a USB cable, select **USB Cable** and click **Next**.
If you are using a parallel cable, select **Parallel Cable**. From the **Ports** drop-down list, select the parallel port on which the printer is connected.



If the setup program detects an existing parallel connection and prompts you, you can choose to install the printer on the port that is detected. In addition, if you select the **Express Install** check box, the setup program will install using default settings.

- 8 Click **Next** and follow the onscreen instructions.
- 9 Connect the USB cable or parallel cable to the computer and the printer when prompted. The Found New Hardware wizard appears on the computer screen and the printer icon is created in the Printers folder.



Connect only the cable you have selected in step 7.

Hardware-first installation



Before you can install the printer software on a computer running Windows XP 64-bit, you must download the printer software from <http://www.hp.com>.

If you have connected a USB cable to the ports on the computer and the printer before installing the printer software, the Found New Hardware wizard appears on the computer screen.

If you have connected a parallel cable and restarted the system, the Found New Hardware wizard appears on the computer screen.

- 1 Click **Next** in the Found New Hardware wizard.
- 2 Click **Search for the best driver for your device (recommended)**, and then click **Next**.
- 3 Insert the Starter CD into the CD-ROM drive.
If the CD menu appears, click **Exit** twice to close the CD menu.
- 4 Select **Specify a location**.
- 5 Click **Browse** to locate the root directory on the Starter CD, and then click **OK**.
- 6 Click **Next** and follow the onscreen instructions.
- 7 Click **Next**, and then click **Finish**.



Upon completion of the hardware-first installation process, the Found New Hardware wizard will automatically launch the setup program. This gives you the option to install non-driver components such as the Toolbox.

For Macintosh

You can connect your printer to Apple computers that use Mac OS 8.6 or later through the USB port. To connect older models without a USB port, you can either connect the Macintosh to a HP Jetdirect print server (Jetdirect 300x), or contact Apple for USB solutions.

Mac OS 8.6, 9.x, and OS X Classic



Mac OS X Classic mode is a Mac OS X feature that lets applications built for Mac OS 9.x to run on a Mac OS X computer. Mac OS X Classic applications have a Mac OS 9.x user interface.

- 1 Insert the Starter CD into your CD-ROM drive and double-click the **CD icon** on the Mac desktop.
- 2 Double-click the installer icon for the Mac OS that you are using.
- 3 Follow the onscreen instructions to complete the installation.
- 4 Connect the USB cable to the printer and computer.

Follow these steps to set the printer as the computer's default printer:

- 1 Select **Chooser** from the Apple menu.
- 2 Select **hp deskjet xx** in the upper left panel of the Chooser, where **xx** represents the version of the current printer driver.
- 3 Select **9300** in the right panel of the Chooser.
- 4 Close the Chooser.

Mac OS X

- 1 Insert the Starter CD into your CD-ROM drive and double-click the **CD icon** on the Mac desktop.
- 2 Double-click the installer icon.
- 3 Follow the onscreen instructions to complete the installation.
- 4 Connect the USB cable to the printer and computer.
- 5 Open the Print Center.
- 6 Click the **Add Printer** button.
- 7 Select **USB** from the menu.
- 8 Select **dj9300** from the printer list.
- 9 Click the **Add** button.

Follow these steps to set the printer as the computer's default printer:

- 1 Open the Print Center.
- 2 Click **dj9300**.
- 3 Do one of the following:
 - From the **Printers** menu, select **Make Default**.
 - Press **Command + D**.

The printer name becomes bold, or a blue bullet appears next to the printer name to indicate that it is the default printer.

Using the printer on a network

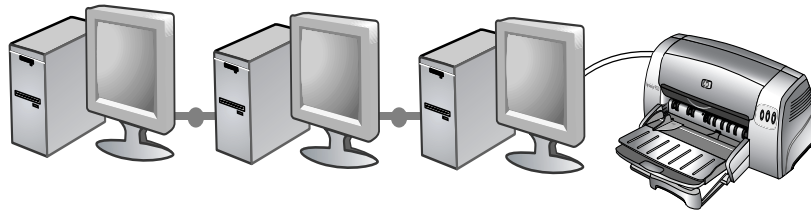

Your printer can be shared in a network environment by connecting it directly to a network via an optional HP Jetdirect external print server. For information about setting up HP Jetdirect print servers, see your HP Jetdirect hardware and software installation guides.

For Windows

Installing the printer driver through network using the printer setup program



You must install your HP Jetdirect print server first, then connect the printer to the network and install the printer software.

- 1 Connect the network cable between the HP Jetdirect print server and a network port.
- 2 Start Windows and make sure no other Windows applications are running.
- 3 Insert the Starter CD into the CD-ROM drive. The CD menu runs automatically. If the CD menu does not run automatically, click **Start**, click **Run**, and in the command line box type the letter of your computer's CD-ROM drive followed by `:\setup` (for example, type `D:\setup`).

- 4 Click **Install Printer Driver** from the CD menu.
- 5 Choose your language and click **OK**.
- 6 Follow the onscreen instructions.
- 7 Click **Connected via the network**, and then click **Next**.
- 8 Click **Client setup for client-server printing**, and then click **Next**.
- 9 Follow the onscreen instructions to complete the installation.

Installing the printer driver through network using Add Printer

- 1 Click **Start**, point to **Settings**, and then click **Printers** (Windows NT 4.0, 98, Me, and 2000) or **Printers and Faxes** (Windows XP).
- 2 Double-click **Add Printer**, and then click **Next**.
- 3 For Windows 98, Me, 2000, or XP, select **Network Printer**.
-Or-
For Windows NT 4.0, select **Network Printer Server**.
- 4 Click **Next**.
- 5 Do one of the following steps:
 - Type in the network path or queue name of the shared printer and click **Next**. Click **Have Disk** when prompted to select the printer model.
 - Click **Next** and locate the printer in the **Shared printers** list.
- 6 Click **Next** and follow the onscreen instructions to complete the installation.

Connecting to a print server

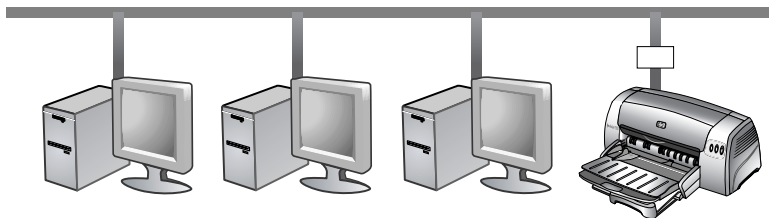

You must install your HP Jetdirect print server first, then connect the printer to the network and install the printer software.

- 1 Click **Start**, point to **Settings**, and then click **Printers** (Windows NT 4.0, 98, Me, and 2000) or **Printers and Faxes** (Windows XP).
- 2 Right-click the printer icon in the Printers folder and select **Properties**.
- 3 Do one of the following:
 - For Windows NT 4.0, 2000, and XP: Click the **Ports** tab, and then click **Add Port**.
 - For Windows 98 and Me: Click the **Details** tab, and then click **Add Port**.
- 4 Select the desired port (such as the HP Standard TCP/IP Port) and click the **New Port** button.
- 5 Click **Next** and follow the onscreen instructions to complete the connection.

Changing print settings

For Windows:

You can access the printing features and change the default print settings from the Printers folder:

- 1 Click **Start**, point to **Settings**, and then click **Printers** (Windows NT 4.0, 98, Me, and 2000) or **Printers and Faxes** (Windows XP).
- 2 Right-click the printer icon in the Printers folder and select **Properties** (Windows 98 or Me), **Document Defaults** (Windows NT 4.0), or **Printing Preferences** (Windows 2000 or XP).

To change the current print settings, access the Print dialog box of the application you are using (typically done by clicking the **File** menu, clicking **Print**, and then clicking **Properties**).

For Macintosh:

To change print settings, click the **File** menu, and then click **Page Setup** or **Print**.

Using the print cartridges

Replacing the print cartridges

Use only the recommended print cartridges. See “[HP supplies and accessories](#)” for part numbers and ordering information.

To load the print cartridges:

- 1 Turn the printer on and open the top cover. The print cartridge cradle will move to the center of the printer.
- 2 Flip up the print cartridge latch, grasp the top of the old print cartridge, and pull it up and out of its cradle.

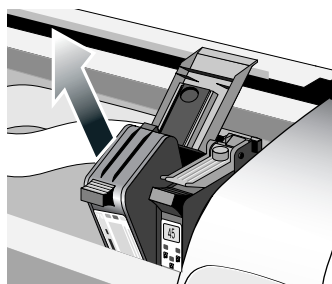

- 3 Remove the new print cartridge from its package, and without touching the ink nozzles or contacts, gently remove the tape covering the ink nozzles.

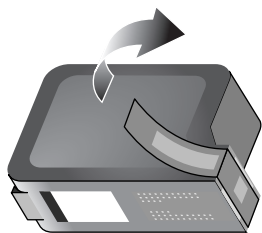

- 4 Push the new cartridge down firmly into its cradle slot, and close the print cartridge latch.

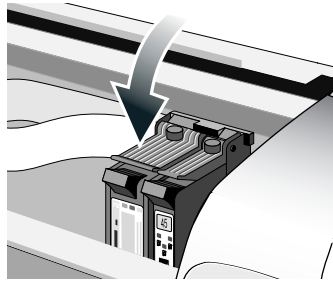

- 5 Close the printer's top cover.

Aligning the print cartridges

The printer has an automatic alignment feature that aligns the print cartridges whenever they are replaced. If the printout looks blurry, you can align them manually.

- 1 Open the Toolbox: Click **Start**, point to **Programs, hp deskjet 9300 series**, and then click **hp deskjet 9300 series Toolbox**.
- 2 Click the **Printer Services** tab.
- 3 Click **Align Print Cartridges**.
- 4 Follow the onscreen instructions to align the print cartridges.



You can also align the print cartridges from the **Services** tab in the printer driver.

Cleaning the print cartridges

The print cartridges for your printer have microscopic nozzles that can clog when exposed to the air for more than a few minutes. The printer is designed to prevent nozzles from drying out when it is idle and when it is turned off by using the Power button.

A print cartridge that is not used for long periods of time can also clog, resulting in a noticeable decrease in print quality. To unclog the nozzles, you need to clean the print cartridges.

Clean the print cartridges if the printed characters are incomplete, or if dots or lines are missing from the printed text or graphics.



Cleaning the print cartridges too often wastes ink and reduces the life of the print cartridges.

To clean the print cartridges:

- 1 Open the Toolbox: Click **Start**, point to **Programs, hp deskjet 9300 series**, and then click **hp deskjet 9300 series Toolbox**.
- 2 Click the **Printer Services** tab.
- 3 Click **Clean Print Cartridges** and follow the onscreen instructions.
- 4 If you still find a problem in the printout, repeat this cleaning process.
- 5 If the printout is still unsatisfactory, use a new print cartridge.



You can also clean the print cartridges from the **Services** tab in the printer driver.

Poor contact between the print cartridges and cartridge cradles might also affect the quality of the printout. When this occurs, try cleaning the print cartridges and cartridge cradles:

- 1 Remove the print cartridge from the printer.

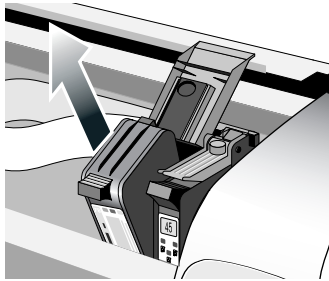

- 2 Clean the electrical contacts on the print cartridge cradle with a dry cotton swab.

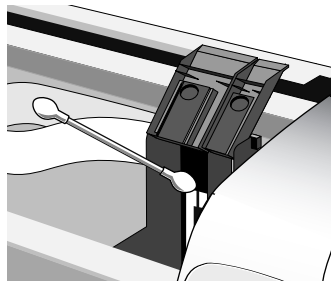

- 3 Clean the electrical contacts on the print cartridge with a dry, lint-free cloth. To prevent damage to the electrical contacts, you should wipe the contacts only once. Do not wipe the ink nozzles on the print cartridge.

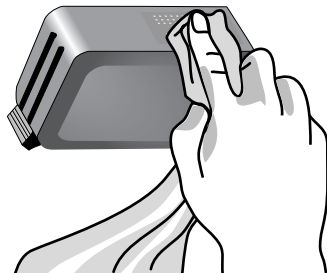

- 4 Reinstall the print cartridge.

Printing from MS-DOS software programs

When printing from MS-DOS®, you can adjust printer settings in two ways: in the HP Deskjet Control Panel for DOS and from within your DOS application's printer driver.



HP Deskjet Control Panel for DOS can be downloaded from <http://www.hp.com/support/dj9300>.

You have access to many printer features through application-specific DOS printer drivers; however, some software manufacturers do not develop printer drivers for their DOS applications. Use HP Deskjet Control Panel for DOS to specify the default printer settings for printing from DOS applications.

3

Printing and loading media

Your HP printer is designed to print on a variety of media, such as plain paper, envelopes, and transparencies. It works well with most office paper types or quality 25 percent cotton bond paper. Because it uses ink to produce an image, paper that accepts ink well produces the best results.

It is best to test a variety of paper types before buying large quantities. Find a paper type that works well. HP inkjet media will produce the best-quality results.

- Paper that is too thin, has a slick texture, or “stretches” easily can feed improperly through the printer’s paper path.
- Paper that is heavily textured or does not accept ink well can cause poorly filled graphics or text.
- To ensure that paper feeds properly, use only one type of paper at a time in the main tray.
- Try to use a paper type that has previously worked well with your printer.

You can print on the media listed below. For details, see [“Printer specifications.”](#)

- Standard paper
- Custom paper
- Envelopes
- Cards
- Thick cards (0.52 mm or 0.02 in.)
- Labels
- Transparencies and slides
- HP special paper



If printing more than one page on transparencies, photo paper, or other special paper, the Resume light blinks after each page has been printed to allow for the printed page to dry before printing the next page. Press the Resume button if you do not want to wait for the printed page to dry before printing the following page.

Loading paper

Main paper tray



The main paper tray is designed to hold the paper type you use most often. It can hold up to 150 sheets of plain paper or 30 transparencies.

To load paper in the main paper tray:

- 1 Lift the output tray and slide the paper width and length adjusters to their outermost positions.

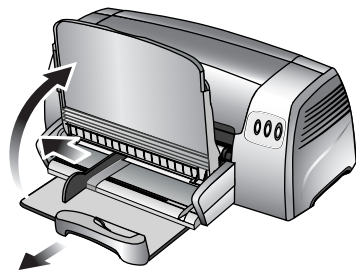

- 2 Insert a stack of paper, up to 19 mm (0.75 in.) or 150 sheets, print-side down along the right side of the main paper tray, until it stops.

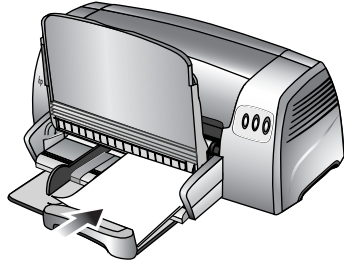

- 3 Slide the paper width and length adjusters in until they stop at the edges of the paper.

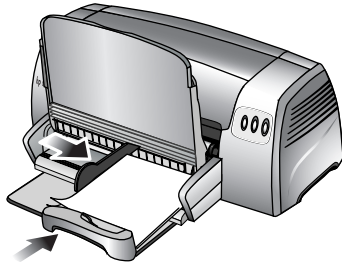

- 4 In the printer driver, change the print settings to match the paper size, type, source, and orientation, and then click **OK**. (For instructions on accessing the printer driver, see [“Changing print settings.”](#))

Rear manual feed



The rear manual feed is designed for printing on thicker paper like cardstock and photo paper without bending or warping. This manual feed is designed to give you a straight paper path.

To feed paper manually:

- 1 In the printer driver, click the **Paper/Quality** tab and select **Manual Feed** from the **Source is** drop-down list. (For instructions on accessing the printer driver, see [“Changing print settings.”](#))
- 2 Change any other print settings if necessary and click **OK**.
- 3 Print your document.
- 4 When the Resume button blinks, insert paper print-side up into the rear manual feed at the back of the printer, making sure that the edge of the sheet is aligned with the alignment mark at the side of the slot.

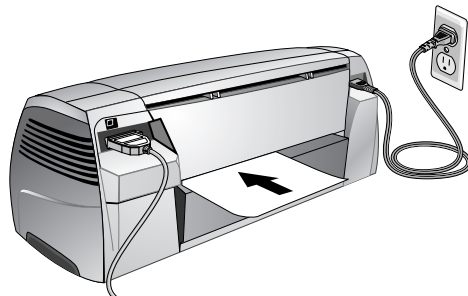

Minimum printing margins

Paper type/size	Minimum printing margins
Letter, Legal, and Executive size paper	Left: 6.4 mm (0.25 in.) Right: 6.4 mm (0.25 in.) Top: 3 mm (0.12 in.) Bottom: 12.7 mm (0.50 in.)
A4-size paper	Left: 3.4 mm (0.13 in.) Right: 3.4 mm (0.13 in.) Top: 3 mm (0.12 in.) Bottom: 12.7 mm (0.5 in.)
A3, A3+, B4-size paper Ledger/Tabloid (11 by 17 in.) Statement Super B (13 by 19 in.) Banner (Tabloid) Banner (A3) Custom	Left: 5.1 mm (0.20 in.) Right: 5.1 mm (0.20 in.) Top: 3 mm (0.12 in.) Bottom: 12.7 mm (0.5 in.)
A5, B5-size paper Cards (4 by 6 in., 5 by 8 in., A6) Envelopes (#10, A2, Monarch, DL, C5, C6) Photos (4 by 6 in.) with tear-off tab	Left: 3.3 mm (0.13 in.) Right: 3.3 mm (0.13 in.) Top: 3 mm (0.12 in.) Bottom: 12.7 mm (0.5 in.)
HP Greeting Card envelopes (4.38 by 6 in.)	Left: 3 mm (0.12 in.) Right: 3 mm (0.12 in.) Top: 3 mm (0.12 in.) Bottom: 12.7 mm (0.5 in.)
Banners - Letter size (8.5 by 11 in.)	Left: 6.4 mm (0.25 in.) Right: 6.4 mm (0.25 in.) Top: 3 mm (0.12 in.) Bottom: 12.7 mm (0.5 in.)
Banners - A4 size (8.27 by 11.7 in.)	Left: 3.4 mm (0.13 in.) Right: 3.4 mm (0.13 in.) Top: 3 mm (0.12 in.) Bottom: 12.7 mm (0.5 in.)

Printing on various paper types and sizes

Printing on transparencies



Use HP Premium Inkjet Transparency Film, which is specifically designed to work with your HP printer. See [“HP supplies and accessories”](#) for part numbers and ordering information.

To print on transparencies:

- 1 Insert HP Premium Inkjet Transparency Film, up to 30 sheets, rough-side down and the adhesive strip pointing forward, along the right side of the main paper tray until it stops.
- 2 Slide the paper width and length adjusters in until they stop at the edges of the transparencies.

3 For Windows:

In the printer driver, click the **Paper/Quality** tab and do the following (for instructions on accessing the printer driver, see [“Changing print settings”](#)):

- In the **Type is** drop-down list, select the appropriate transparency media (such as HP Premium Inkjet Transparency Film).
- In the **Size is** drop-down list, select the size of your transparency (such as Letter or A4).
- In the **Source is** drop-down list, select **Tray 1**.
- In the **Print Quality** drop-down list, select **Best**.

For Macintosh:

- Select the size of your transparency (such as Letter or A4).
- Open the **Paper Type/Quality** panel and select the appropriate transparency media (such as HP Premium Inkjet Transparency film).
- Select **Tray 1**.
- Click the **Quality** tab and select **Best**.



Use Best mode to print transparencies. This mode provides a longer drying time and ensures that the ink dries completely before the next page exits the printer.

4 Change any other print settings if necessary and click **OK**.

5 Print your transparencies.



It is recommended to remove each transparency as it prints and set it aside to dry. Allowing wet media to stack up may cause smearing.

Printing on HP media



Use HP media for optimum print quality. These media types are specifically designed to work with your HP printer. They include HP Premium Inkjet Paper, HP Premium Photo Paper, HP Bright White Paper, and HP Greeting Card Paper. See [“HP supplies and accessories”](#) for part numbers and ordering information.

To print on HP media:

- 1 Insert a stack of HP media, up to 19 mm (0.75 in.) or 150 sheets, print-side down along the right side of the main paper tray, until it stops.
- 2 Slide the paper width and length adjusters in until they stop at the edges of the paper.

3 For Windows:

In the printer driver, click the **Paper/Quality** tab and do the following (for instructions on accessing the printer driver, see [“Changing print settings”](#)):

- In the **Type is** drop-down list, select the appropriate HP media (such as HP Premium Inkjet Paper).
- In the **Size is** drop-down list, select the size of your HP media (such as Letter or A4).
- In the **Source is** drop-down list, select **Tray 1**.
- In the **Print Quality** drop-down list, select **Best**.

For Macintosh:

- Select the size of your HP media (such as Letter or A4).
 - Open the **Paper Type/Quality** panel and select the appropriate HP media (such as HP Premium Inkjet Paper).
 - Select **Tray 1**.
 - Click the **Quality** tab and select **Best**.
- 4 Change any other print settings if necessary and click **OK**.
 - 5 Print your document.

Printing on standard-sized paper

To print on standard-sized paper:

- 1 Insert a stack of paper, up to 19 mm (0.75 in.) or 150 sheets, print-side down along the right side of the main paper tray, until it stops.
- 2 Slide the paper width and length adjusters in until they stop at the edges of the paper.
- 3 In the printer driver, change the necessary print settings and click **OK**. (For instructions on accessing the printer driver, see [“Changing print settings.”](#))
- 4 Print your document.

Your application might override print settings. Check **Page Setup** or **Print Setup** in your application to change default paper sizes.

Printing on custom-sized paper

To print on custom-sized paper:



The paper width must be between 89 mm and 330 mm (3.5 in. and 13 in.); the paper length must be between 146 mm and 1,270 mm (5.75 in. and 50 in.).

- 1 Insert a stack of paper, up to 19 mm (0.75 in.) or 150 sheets, print-side down along the right side of the main paper tray, until it stops.
- 2 Slide the paper width and length adjusters in until they stop at the edges of the paper.
- 3 Before running your application, open the printer driver to set the desired custom paper size. (For instructions on accessing the printer driver, see [“Changing print settings.”](#))
- 4 **For Windows:**

In the printer driver, click the **Paper/Quality** tab and do the following:

- Click the **Custom** button next to the **Size is** drop-down list. The **Custom Paper Size** dialog box appears.
- Under **Paper Size**, type values in the **Width** and **Length** boxes. You can save the settings using any of the predefined names if desired. Click **OK**.
- In the **Source is** drop-down list, select **Tray 1**.

For Macintosh:

- Click the **File** menu and then click **Page Setup**.
 - Select **Edit Custom Page Sizes** from **Page Size**.
 - Under **Edit Paper Sizes**, type values in the **Width** and **Height** boxes. You can save the settings using any of the predefined names if desired. Click **Done**.
- 5 Change any other print settings if necessary and click **OK**.
 - 6 Run the application and print your document.

Printing on envelopes

To print on envelopes:

- 1 Make sure all media is removed from the main paper tray.
- 2 Slide the envelopes into the main paper tray, with the flaps facing up and to the right, until they stop.

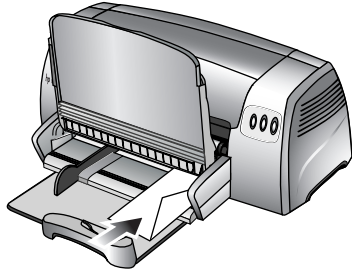

- 3 Slide the paper width and length adjusters in until they stop at the edges of the envelopes.

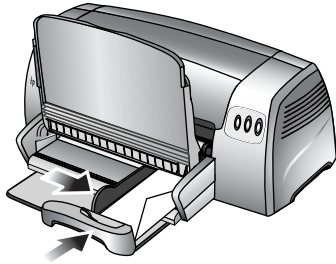

4 For Windows:

In the printer driver, click the **Paper/Quality** tab and do the following (for instructions on accessing the printer driver, see [“Changing print settings”](#)):

- In the **Size is** drop-down list, select the envelope size.

For Macintosh:

- Select the envelope size.

- 5 Change any other print settings if necessary and click **OK**.
- 6 Print your envelopes.

Printing on cards

To print on cards:

- 1 Insert a stack of cards, up to 19 mm (0.75 in.) in thickness, print-side down along the right side of the main paper tray, until it stops.
- 2 From the length adjuster, extend the postcard guide.

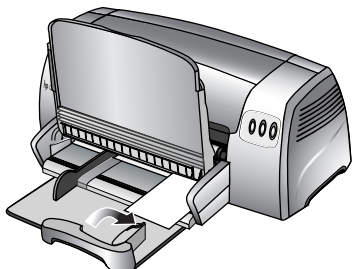

- Slide the postcard guide and the paper width adjuster in until they stop at the edges of the cards.

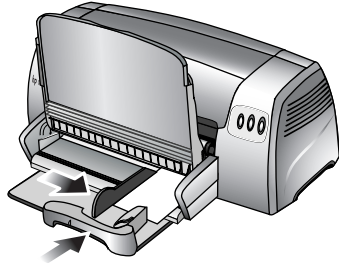

- For Windows:**

In the printer driver, click the **Paper/Quality** tab and do the following (for instructions on accessing the printer driver, see [“Changing print settings”](#)):

- In the **Type is** drop-down list, select the paper type you are using (such as HP Textured Greeting Cards).
- In the **Size is** drop-down list, select the size of the cards you are printing; or click **Custom** if none of the sizes match the card size you are printing.

For custom-sized card printing instructions, see [“Printing on custom-sized paper.”](#)

- For Macintosh:**

- Select the size of the cards you are printing.
- Open the **Paper Type/Quality** panel and select the paper type you are using (such as HP Textured Greeting Cards).

For custom-sized card printing instructions, see [“Printing on custom-sized paper.”](#)

- Change any other print settings if necessary and click **OK**.

- Print your cards.



If your card is made of thicker paper (such as cardstock), you can choose to feed the card manually. For instructions on feeding paper manually, see [“Rear manual feed.”](#)

Printing on thick plain paper or photo paper



The rear manual feed is designed for printing on thicker paper (up to 280 g/m² / 74 lb bond; 0.52 mm / 0.02 in.) like cardstock and photo paper without bending or warping. This manual feed is specially designed to give you a straight paper path.

For the best results when printing photographs and images, choose Best mode and select an HP photo paper in the printer driver. Best mode uses HP's unique PhotoREt III color-layering technology and ColorSmart III color optimization technology to create realistic photo images, vivid color output, and extremely sharp text. With PhotoREt III, a greater range of colors, lighter tones, and smoother gradations between tones can be achieved, ensuring the best photo and image print quality.

To print on thick plain paper or photo paper:

- For Windows:**

In the printer driver, click the **Paper/Quality** tab and do the following (for instructions on accessing the printer driver, see [“Changing print settings”](#)):

- In the **Type is** drop-down list, select the paper type you are using (such as HP Premium Plus Photo Paper).
- In the **Size is** drop-down list, select the paper size (such as Letter or A4).

- In the **Source is** drop-down list, select **Manual Feed**.
- In the **Print Quality** drop-down list, select **Best**. Alternatively, you can select **4800 x 1200 Optimized dpi*** high-resolution print mode for optimum print quality. In this mode, printing will take longer because more memory is required in your computer.

For Macintosh:

- Select the paper size (such as Letter or A4).
 - Open the **Paper Type/Quality** panel and select the paper type you are using (such as HP Premium Plus Photo Paper).
 - Select **Manual Feed**.
 - Click the **Quality** tab and select **Best**. Alternatively, you can select **High Resolution Photo**, which provides up to 4800 x 1200 Optimized dpi*, for optimum print quality. In this mode, printing will take longer because more memory is required in your computer.
- 2 Change any other print settings if necessary and click **OK**.
 - 3 Print your document.
 - 4 Insert paper into the rear manual feed at the back of the printer.
For instructions on feeding paper manually, see [“Rear manual feed.”](#)



It is recommended to remove each sheet of paper as it prints and set it aside to dry. Allowing wet paper to stack up may cause smearing.



*Up to 4800 x 1200 Optimized dpi color printing on HP Premium Photo Papers and 1200 x 1200 input dpi.

Printing on both sides of the paper

You can print on both sides of a sheet of paper by manually turning a sheet of paper over and feeding it into the printer again.

To print on both sides of a page, you must specify two-sided printing options in your software application or in the printer driver.



For best results when printing, do not print on paper heavier than 135 g/m² (36 lb bond); on both sides of labels or transparencies; or on both sides of pages that are covered densely with ink.



It is recommended to remove each sheet of paper as it prints and set it aside to dry. Allowing wet paper to stack up may cause smearing.

For Windows

- 1 Load the appropriate paper, print-side down along the right side of the main paper tray, until it stops.
- 2 Slide the paper width and length adjusters in until they stop at the edges of the paper.
- 3 In the printer driver, click the **Finishing** tab and then select **Print on Both Sides**. (For instructions on accessing the printer driver, see [“Changing print settings.”](#))
- 4 Select **Flip Pages Up** to change the page orientation, if desired.
- 5 Choose a booklet layout from the **Booklet Layout is** drop-down list, if desired.
- 6 Click the **Paper/Quality** tab, and then in the **Print Quality** drop-down list select either **Normal** or **Best**.

- 7 Change any other print settings if necessary and click **OK**.
- 8 Print your document.
- 9 After the first side of the page(s) is printed, turn the paper over and reload it into the printer.
- 10 Follow the onscreen instructions to complete the two-sided printing.

For Macintosh

- 1 Load the appropriate paper, print-side down along the right side of the main paper tray, until it stops.
- 2 Open the **Layout** panel.
- 3 Select **Print Both Sides**, the binding orientation you desire (select the appropriate icon), and then select **Manual**.
- 4 After the first side of the page(s) is printed, turn the paper over and reload it into the printer.
- 5 Follow the onscreen instructions to complete the two-sided printing.

Understanding smart software features

Your printer driver provides the following smart software features. For more details on how to use these features, see the driver online help.

Resizing Options

Enlarge or reduce the size of your documents with virtually no loss in print quality or resolution. On the **Effects** tab, select the **Print Document On** check box, and then select the desired document size, followed by the **Scale to Fit** check box.

Alternatively, you can make use of the **% of Normal Size** scroll bar to adjust the document size. You can zoom from 25 to 400 percent of the original document size, but page content might get truncated at times.

Print on Both Sides

Print on both sides of the paper to create professional looking brochures and catalogues. On the **Finishing** tab, select the **Print on Both Sides** check box. If you wish to bind the printouts by the top, also select the **Flip Pages Up** check box.

Booklet Layout is

Produce booklets without worrying about pagination. This feature is available only when **Print on Both Sides** on the **Finishing** tab is selected. All you need to do is fold the pages and bind them into a booklet. You can choose to bind the booklet on the left or the right side by selecting the left or the right edge binding.

Pages per Sheet

Arrange up to 16 pages on a single sheet of paper to reduce printing costs. You can arrange the order of the layout with the **Page Order is** selections. On the **Finishing** tab, select two or more pages from the **Pages per Sheet** drop-down list, and then select the desired layout order from the **Page Order is** drop-down list.

Tiling

Take a one-page document and enlarge it up to five times (5 x 5) for documents up to A3+ (13 by 19 in.) size. The enlarged document can be printed on several sheets and assembled to form a large billboard. On the **Finishing** tab, select the number of tiles you wish to create.

Mirror Image

Flip a page horizontally. This lets you write on the underside of a transparency film, leaving the topside available for annotations with marker pens. On the **Basics** tab, select the **Mirror Image** check box.

Banner printing

Print large images and bold, oversized fonts on continuous feeds of paper. On the **Paper/Quality** tab, select **HP Banner Paper** from the **Type is** drop-down list.

Print in Sepia and Print in Grayscale

Print images in a brownish tone to give them an antique look using the **Print in Sepia** feature. Alternatively, print in grayscale by selecting **Print in Grayscale**. Both black and white and color documents can be converted to exhibit this effect.

Watermarks

Set short text such as CONFIDENTIAL or URGENT as the background for your document's main text. You can customize and rotate the watermark according to your preference. This feature is found on the Effects tab.

Optimize for Photocopy or Fax

Color images sometimes translate into poor printouts when put through a black and white facsimile or photocopier. The Optimize for Photocopy or Fax feature prints images using high-contrast shades of gray, making them ideal for faxing and photocopying. On the **Color** tab, select the **Print in Grayscale** check box, and then select **Optimize for Photocopy or Fax**.

4

Using the Toolbox

The Toolbox provides status and maintenance information about your printer. It also gives you step-by-step guidance for basic printing tasks and provides help for solving printer problems. You can also access online resources for your printer.



The Toolbox is available for Windows only. For Macintosh, see “[Using the HP Inkjet Utility \(Macintosh\)](#).”

After installing your printer software, you can open the Toolbox by clicking **Start**, pointing to **Programs**, **hp deskjet 9300 series**, and then clicking **hp deskjet 9300 series Toolbox**.

Printer Status tab

The **Printer Status** tab displays ink level information for each cartridge in 10 percent increments, as well as printer status.

The printer selection drop-down list lets you select the printer you want to use with the Toolbox utilities. It lists printers that are compatible with the Toolbox. The status window displays messages related to current printer status, such as *Printing job*, *Access cover open*, and *Print cartridge empty*.

Click the **Preferences** button to select which Toolbox messages to appear for all printers that need to be monitored and maintained. When there is a status error or warning message displayed on the computer screen, you can click the printer icon to invoke the help file to display detailed information about the error status.

Information tab

The **Information** tab lets you register the printer and display printer hardware information. It also provides access to online troubleshooting through hp instant support, as well as information about your printer usage, using the printer, troubleshooting, and contacting HP.

Click this button...	To...
myPrintMileage	Access the myPrintMileage website and your printer usage information, which includes printer usage patterns (ink and media use).
Printer Hardware	Display detailed printer information such as model, firmware version, and service ID.
hp instant support	Access the hp instant support website for support services and troubleshooting tips.
Register Your Printer	Register the printer online.
How Do I...	View a list of common printer tasks and help on common maintenance tasks.
Troubleshooting	View a list of printing problems with step-by-step instructions to help solve them.
Contact HP	Obtain information on how to contact HP.
Order Supplies	Purchase printing supplies, such as print cartridges, online. You must have Internet access to perform this operation.
Supplies Information	View information on HP supplies and also ordering information.

hp instant support

hp instant support is a Web-based tool that provides you with product-specific services, troubleshooting tips, and information about your printer's ink and media usage (via myPrintMileage). With this information, you can diagnose and solve printer problems, and manage your printing activities and printer supplies more effectively.

hp instant support provides the following services for your printer:

- Easy access to troubleshooting tips
To help you quickly resolve printer problems or prevent some problems from happening, hp instant support provides tips that are customized for your printer.
- Notification of driver and firmware updates
When a firmware or driver update for your printer is available, a notification message will appear on the hp instant support homepage. You can access the download site from the web page.
- Access to hp services
From the website, you can find out more about the support services available for your printer (such as maintenance programs), get information about service providers, and also make online purchase of printer supplies and accessories.
- Notification of warranty expiration
When the printer warranty is expiring, a notification message will appear on the hp instant support homepage.



hp instant support web pages are dynamically created. This means that bookmarking this site in your browser and connecting via the bookmark will not display the current information. Instead, connect from the Toolbox by clicking the **hp instant support** button on the **Information** tab.

myPrintMileage

myPrintMileage keeps track of your printer usage information to help you plan the purchase of consumables. It consists of two parts:

- myPrintMileage website
- myPrintMileage Agent (a utility installed on your computer with the Toolbox that is activated during installation of the printer driver only if you choose to participate)

You can visit the myPrintMileage website from the Toolbox by clicking the myPrintMileage button or double-clicking the myPrintMileage Agent icon on the Windows taskbar (near the clock). On this website, you can see:

- Your ink usage. For example, the amount of ink you have used.
- Your media usage. For example, the average quantity of media you use per month for each media type.
- The applications that you use to print with the printer.
- Job and page count. For example, the number of pages that have been printed and the estimated number of pages that can be printed with the amount of ink remaining.
- The driver features that you frequently use.



myPrintMileage websites are dynamically created. Bookmarking this site and connecting using the bookmark will not display the current information. Instead, connect from the Toolbox by clicking the **myPrintMileage** button on the **Information** tab.

You can enable and disable myPrintMileage at any time by right-clicking the myPrintMileage Agent icon on the Windows taskbar and clicking **Enable** or **Disable**.

Ordering printing supplies directly through the Toolbox

The Toolbox lets you order print cartridges directly from your computer. There are three requirements to use this feature:

- The Toolbox must be installed on your computer.
- The printer must be connected to your computer using either a USB cable, a parallel cable, or a network connection.
- You must have Internet access.

To order directly through the Toolbox

- 1 In the status area of the Windows taskbar (near the clock), double-click the Toolbox icon.
- 2 On the **Printer Status** tab, click **Order Supplies**. The default browser opens and displays a website from which you can purchase printing supplies.
- 3 Follow the instructions on the website to select and order printing supplies.

Printer Services tab

The **Printer Services** tab provides utilities that help you maintain and test your printer. You can align and clean your print cartridges, or print a demo page.

Click this button...	To...
Align Print Cartridges	Align the print cartridges. See “Aligning the print cartridges” for more information.
Clean Print Cartridges	Clean the print cartridges. See “Cleaning the print cartridges” for more information.
Print a Demo Page	Send a demo page to the printer to verify that the printer is connected to the computer correctly and is working properly.

Using the HP Inkjet Utility (Macintosh)

For Mac OS 8.6, 9.x and OS X, the HP Inkjet Utility contains tools to calibrate the printer, clean the print cartridges, print a test page, and find website support information.

Displaying the HP Inkjet Utility

- 1 Double-click the **Macintosh HD** icon on the desktop.
- 2 Do one of the following:
 - Mac OS 8.6 to 9.0: Select **Utilities**, and then **hp inkjet**.
 - Mac OS 9.1: Select **Applications (Mac (OS 9))**, **Utilities**, and then **hp inkjet**.
 - Mac OS X: Select **Applications**, and then **Utilities**.
- 3 Select **hp inkjet utility**.

Viewing the HP Inkjet Utility panels

The following options are available on the HP Inkjet Utility Panel menu:

- **WOW!:** Prints a sample page to view the print output quality.
- **Test:** Prints a test page or a diagnostic page.
- **Clean:** Cleans the print cartridges.
- **Calibrate Device:** Aligns the print cartridges.
- **Calibrate Color:** Adjusts color to correct problems with tint.
- **Estimate Ink Levels:** Displays print cartridge ink levels.
- **Support:** Provides access to the HP website where you can find support for the printer and information about HP products and supplies.
- **Register:** Accesses the HP website to register the printer.

5 Troubleshooting

This chapter provides solutions to common problems, such as paper jams and poor print quality. If your printer is not operating properly and these suggestions do not solve your problem, try to print a diagnostic page, and then contact HP Customer Support (see [“Printing a diagnostic page”](#) and [“Customer Support”](#)).

Power cannot be turned on

- Check that the power cord is connected.
- Check that the removable panel, located at the back of the printer, is tightly pushed into the slot and that the knob is in the lock position.



Printer is not responding (nothing prints)

- Check the power.
Make sure the power cord is connected firmly to the printer and to a working outlet, and that the printer is turned on. The Power light on the front panel of the printer should be lit.



If you tried to print when the printer was turned off, you should have seen an alert message on your screen. If the printer was off and you did not see a message when you tried to print, the printer setup might be incorrect. To correct this, reinstall the printer software.

- Check the cables.
Make sure the printer cable is firmly connected between the printer and the computer.
- Check the rear panel knob.
Make sure the rear panel is correctly installed and the knob is in the lock position. The printer will not function until the knob is in the lock position.
- Check the printer setup.
Make sure your HP deskjet printer is selected as the current or default printer and that **Pause Printing** is not selected in the Printer menu.
- Be patient.
Complex documents containing many fonts, graphics, and/or color photos take longer to begin printing. If the Power light is blinking, the printer is processing information.
- Check the paper.
Make sure paper is loaded correctly in the tray and that the paper is not jammed in the printer. See [“Loading paper”](#) and [“Paper is jammed in the printer”](#) for more information.
- Check the print cartridges.
Make sure that both the black and color print cartridges are properly installed and that the access cover of the printer is closed (see [“Replacing the print cartridges”](#) for more information). The Print Cartridge light flashes if the print cartridges are not installed correctly. See [“Printer lights blink”](#) and [“Print cartridge problem”](#) for more information.

- Try printing a sample page.
Turn the printer off, and then back on. Press the Resume button and release it when the Resume light starts to blink. If the sample page prints, then the problem is not with the printer.
- Try printing from another application.
Try printing from other applications to see if this problem recurs.
- Try printing a test page.
Print a generic Windows test page: Click **Start**, point to **Settings**, and then click **Printers** (Windows NT 4.0, 98, Me, and 2000) or **Printers and Faxes** (Windows XP). Right-click the printer icon and select **Properties**. Click the **General** tab, and then click **Print Test Page**.

If the test page prints and the printer previously worked with the same software program you are using, try printing another file using the software. If this file prints, the file you were previously trying to print might be damaged. If you have a backup copy of the file, try printing it. If none of the above solutions worked, this problem is likely caused by your software program's inability to properly interpret print settings. Check the readme file on the Starter CD for known software conflicts. Otherwise, check your software program manual, or call the software manufacturer to get more specific help for this problem.

If the test page does not print, ensure that the correct port (USB, LPTx) is selected and that the printer is connected directly to your computer. If your printer is connected to a switch box, make sure that you have selected the correct switch. When printing the test page, the printer Power light should flash. If your Power light does not flash, print a diagnostic page. See [“Printing a diagnostic page”](#) for instructions.

- Check the network setup.
Make sure that your printer is properly set up in your network environment. See [“Using the printer on a network”](#) and the documentation provided by your network vendors. Also see [“Network printing problem”](#) for additional troubleshooting information.
- Check the Chooser (Mac OS 8.6 and 9.x only).
Make sure you have installed the printer software and the printer is selected. The printer version should be visible on the left panel of the Chooser. When you click the printer icon, the printer name should be available on the right panel of the Chooser. Select the printer's name.
- Check the USB port.
Unplug the printer from the USB port, wait a few seconds, then plug it back in. If that does not help, try plugging the printer into another USB port.
- Check the condition of the cable.
Make sure the cable to your printer is not damaged or frayed. If it is, contact the manufacturer of the cable and have it replaced.
- Uninstall the printer software and run the setup program again. Ensure that you turn on the printer's power and connect only the cable you have selected during installation when prompted to do so.

Paper feed problem

- Make sure there is no paper jam.
To clear a jam, see [“Paper is jammed in the printer.”](#)
- Check that paper is loaded correctly.
Make sure the paper width and length adjusters fit snugly against the left and bottom edges of the paper stack. See [“Loading paper”](#) for more information.
- Check the paper type.
Some paper types are not suitable for use with your HP printer. See [“Printing and loading media”](#) for information on recommended media.

- Make sure you only load one type of paper at a time.
- Check that there is sufficient paper in the tray.
- If none of the above solutions worked, print a diagnostic page.
See [“Printing a diagnostic page”](#) for instructions.

Paper skew problem

If paper is twisting as it feeds or margins appear crooked, make sure both the bottom and side paper guides are gently pressed against the paper.

Paper is jammed in the printer

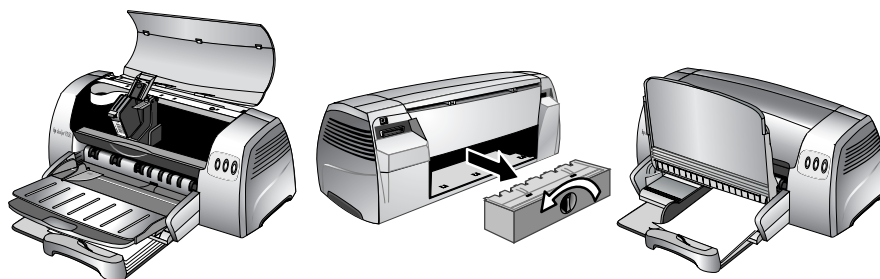

To clear the printer of any jammed paper, open the access cover and pull the paper towards you. If you cannot reach the jammed paper, turn the panel knob at the back of the printer, remove the panel, pull out the jammed paper, and replace the panel. If you still cannot reach the paper, lift up the output tray, and remove the jammed paper from the main paper tray.

Tips for avoiding paper jams

- Make sure nothing blocks the paper path.
- Do not use media that is damaged, curled, or wrinkled. It is recommended not to use paper with cutouts or perforations or paper that is heavily textured or embossed.
- Load only one paper type at a time into any of the trays.
- Except when using manual feed, load the paper print-side down with the right edge of the paper aligned against the right edge of the tray.
- Do not load more than 150 sheets (or 19 mm-height stack) of paper or 15 envelopes into the main tray at one time. Load only one sheet of paper into the manual feed tray.
- Always use paper that conforms with those listed in [“Printer specifications.”](#) For information on recommended media, see [“Printing and loading media.”](#)

A blank page is ejected

- Check that the protective tape is removed from the ink nozzles on the print cartridges.
- Check for an empty print cartridge.
If you are printing black text and a blank page prints, your black print cartridge might be empty. Check the printer LEDs to make sure they are not on (see [“Printer lights blink”](#) and [“Print cartridge problem”](#) for more information). Replace the empty black print cartridge and try to print again. See [“Replacing the print cartridges”](#) for instructions.
- Check the printer setup.
Make sure your printer is selected as the current or default printer.

- Check for conflicts with port-sharing devices.
If you are using a parallel cable, make sure your printer is connected directly to the parallel port. Do not share the port with other devices such as a Zip drive or other printers.
- Check whether the printer is shared.
If you are sharing your printer, see [“Network printing problem”](#) for troubleshooting information.

Poor print quality



Open the top cover when you suspect a print cartridge problem. The inside top case has icons on it showing cartridge problems. If there is a problem, the yellow arrow on the cartridge cradle points to the icon that indicates the problem.

Printout is faded or colors are dull

- Check the Print Quality setting.
The Fast option uses less ink and prints at a faster rate, which is good for printing drafts. To achieve better colored printout, select Normal or Best quality in the printer driver.
- Check the Paper Type setting.
When printing on transparencies or other special paper types, select the corresponding paper type in the printer driver.
- Check the type of paper you are using.
Some paper types are not suitable for use with your HP printer. For information on recommended media, see [“Printing and loading media.”](#)
- Check the print cartridges for low ink or clogs:
 - Whenever print quality deteriorates, it is a good idea to clean the print cartridges and then print a test page. See [“Cleaning the print cartridges”](#) for instructions.
 - Check that all the lines on the test page are connected and printed properly. If the lines are broken, your print cartridge is probably out of ink. Replace your print cartridge with a new one (see [“Replacing the print cartridges”](#) for instructions). However, if you have recently replaced your cartridge, your cartridge is probably defective. See [“HP supplies and accessories”](#) for replacement information.

Colors are bleeding into each other

- Check the Print Quality setting.
Some Paper Type settings (such as Transparency) and Print Quality settings (such as Best) require more ink than others. Choose different print settings in the printer driver. Also, make sure that you have selected the correct paper type in the printer driver.
- Check the Paper Type setting.
Some paper types are not suitable for use with your HP printer. For information on recommended media, see [“Printing and loading media.”](#)
- If you refilled your print cartridges, HP does not recommend or support refilled print cartridges.
Refilling processes and the use of incompatible inks might disrupt the intricate printing system, potentially resulting in reduced print quality and even printer damage. To order the original HP print cartridge, see [“HP supplies and accessories.”](#)

When printing on photo paper and transparency film:

- Ensure that the paper is inserted print-side down when loaded from the front manual feed tray or main paper tray.
- Ensure that the paper is inserted print-side up when loaded from the rear manual feed.
- Use only HP Inkjet Transparency Films listed under [“HP supplies and accessories.”](#)

Ink is smearing onto white (blank) areas

- The printout needs time to dry.
When printing documents that use a lot of ink, you must allow the document more time to dry before handling it. This is especially true for transparencies. Check immediately after printing whether smearing occurs in the printout. You can increase the amount of dry time in the printer driver.
- Some types of paper do not accept ink well, which causes the ink to dry more slowly and results in smearing. For information on recommended media, see [“Printing and loading media.”](#)
- The page is wrinkling with too much ink.
Color documents with rich, blended colors can use excess ink, which wrinkles the page during printing and causes smearing. Try using the Normal or Fast Print Quality setting to reduce ink, or use HP Premium Paper designed for inkjet printing of vivid color documents.
- Check for excess ink buildup on the print cartridge.
An ink buildup problem can be solved by cleaning the cartridges. See [“Cleaning the print cartridges”](#) for instructions.

Ink is not filling the text or graphics completely

- Check the print cartridges:
 - The print cartridge might be low or out of ink. Check the printer LEDs to make sure they are not on (see [“Printer lights blink”](#) and [“Print cartridge problem”](#) for more information). Replace any low or empty print cartridges, then try to print again. See [“Replacing the print cartridges”](#) for instructions.
 - Whenever print quality noticeably decreases it is a good idea to clean them. See [“Cleaning the print cartridges”](#) for instructions.
 - If the print cartridges have poor contact, try removing and then reinstalling the print cartridges, making sure to snap them firmly into place. See [“Replacing the print cartridges”](#) for instructions.
- Check the paper type.
Some paper types are not suitable for use with your HP printer. For information on recommended media, see [“Printing and loading media.”](#)
- If none of the above solutions worked, try printing using Best mode.

Text is jagged at the edges (not smooth)

- Check the type of font chosen.
Some software programs offer custom fonts that have jagged edges when enlarged or printed. By using TrueType fonts you can ensure that the printer is able to print smooth fonts. When selecting a font, look for the TrueType icon.

- If you are trying to print a bitmap image of text, it might have jagged edges when skewed, enlarged or printed.
By using TrueType fonts you can ensure that the printer is able to print smooth fonts. When selecting a font, look for the TrueType icon.
- Check the paper type.
Paper that is heavily textured or does not accept ink well can cause graphics and text to print poorly. For information on recommended media, see [“Printing and loading media.”](#)
- If none of the above solutions worked, the problem is likely a conflict related to the software package you are using.
Check the readme file on the Starter CD for known software conflicts. Otherwise, check your software program manual or call the software manufacturer to get more specific help for this problem.

Something on the page is missing or incorrect

- The margin settings might be incorrect.
Make sure the margin settings for the document do not exceed the printable area of your printer.
- Color print settings might be incorrect.
Grayscale might be selected in the printer driver.
- The incorrect printer might be selected.
Make sure the correct printer is selected as the current or default printer.

Unexpected results

Text or graphics are cut off at page edges

- Check the page orientation setting.
The page orientation selected might not be correct for the document you are printing. See [“Changing print settings”](#) for instructions.
- Check the margin settings.
Make sure margin settings for the document do not exceed the printable area of your printer. See [“Minimum printing margins.”](#)
- Make sure the content fits on the page:
 - Content that is cut off might be outside the printable area. Or, the size of the document you are printing is larger than the paper size in the main paper tray.
 - You can use the built in print preview feature to check the document before it prints. Check the graphics in the document to make sure that their current size (scale) fits within the printable area of the printer.
 - If the layout of the document you are trying to print will fit on a paper size supported by the printer, then load the correct paper size. Make sure to select the correct page orientation.
 - Sometimes software packages allow you to select a print mode that scales the document to fit the paper size currently selected.
- Make sure the paper is loaded correctly.
Make sure the paper width and length adjusters fit snugly against the left and bottom edges of the paper stack. Also, make sure that the correct paper orientation is selected. See [“Loading paper”](#) and [“Changing print settings”](#) for more information.

- If none of the above solutions worked, the problem is likely a conflict related to the software package you are using.
Check the readme file on the Starter CD for known software conflicts. Otherwise, check your software program manual or call the software manufacturer to get more specific help for this problem.

Placement of the text or graphics is incorrect

- Check the paper size and orientation settings.
Make sure the paper size and page orientation selected in the software program match the settings in the printer driver.
- Make sure the paper is loaded correctly.
If everything on the page is slanted or skewed, make sure the paper width and length guides fit snugly against the left and bottom edges of the paper stack and that there are no more than 150 sheets of paper loaded in the main paper tray.
- Check the margin settings.
If the text or graphics are cut off at the edges of the page, make sure the margin settings for the document do not exceed the printable area of your printer. See [“Minimum printing margins”](#) for more information.

Meaningless characters are printed

- Check the cable connection.
A common cause for nonsense characters is a poor cable connection between the printer and computer.
- The wrong printer might be selected.
Check to make sure your printer is selected as the current or default printer.
- The document file might be damaged.
This happens occasionally. If you can print other documents from the same software package, try to print using a backup copy of your document.
- Check for conflicts with port-sharing devices.
If you are using a parallel cable, make sure your printer is connected directly to the parallel port. Do not share the port with other devices such as a Zip drive or other printers.
- The system might need to be restarted.
Turn the printer and computer off, wait a few seconds, turn them both back on, and then try printing again.

Wrong fonts are printed

- Fonts might be used incorrectly in the document.
Make sure you correctly apply the font you have chosen. For example, in a paint program place the words in the desired size; do not enlarge by dragging and sizing.
- Make sure the font is available on your computer.
The fonts used in the document might not match the fonts currently available in your Windows system, or the type of font used is not designed to be printed. See if the font that is printing incorrectly is available in your software program's font selection box, and see if it is a TrueType font (recommended).
- The wrong printer might be selected.
Check to make sure your HP printer is selected as the current or default printer.

- If none of the above solutions worked, the problem is likely a conflict related to the software package you are using. Check the readme file on the Starter CD for known software conflicts. Otherwise, check your software program manual or call the software manufacturer to get more specific help for this problem.

Colors are different than they should be

- When colors are completely wrong (for example, when green prints as blue or yellow), the color cartridge might have run out of one or more colors of ink. To check the ink levels of your print cartridges in Windows, go to the Toolbox (if you have installed it on your system). To open the Toolbox, click **Start**, point to **Programs**, **hp deskjet 9300 series**, and then click **hp deskjet 9300 series Toolbox**.
After printing a test page, clean the print cartridges if necessary. See [“Cleaning the print cartridges”](#) for instructions.
- Colors are gray or are the correct color but the wrong shade:
 - If colors are printing in shades of gray, the **Print in Grayscale** check box is probably selected in the printer driver. For color printing, uncheck the **Print in Grayscale** check box on the **Color** tab.
 - If the hue or tone of color is shifted, the wrong setting might be selected in the printer driver. Select the **Color** tab and make sure the color sliders are centered.
- Check the paper type.
Colored paper might cause the mismatch in the printout. Try printing on plain white paper.

Slow printing

To enhance the performance of your printer, check the following:

- Use an IEEE-1284 parallel cable to enable bidirectional communication.
- Check your system configuration:
 - See [“Printer specifications”](#) for minimum system requirements.
 - There might be insufficient hard disk space in your system
For printing on 11-by-17 inch paper, it is recommended that you have at least 50 MB of additional free hard disk space in your system. If you are printing graphics-intensive or photographic image files, make sure you have enough (more than 50 MB) additional hard disk space.
 - There might be insufficient virtual memory in your system
Increase the size of your system’s virtual memory.
- Check your port and cable settings (Windows 98/Me only):
 - If you are using a parallel connection, try switching to a USB connection. For more information, see [“Connecting the printer.”](#)
 - The port setting configuration in your system is not set to ECP
See the manual that comes with your computer for information on how to change your port setting or contact your computer manufacturer.
- A print cartridge might be low on ink.
Check the printer LEDs to make sure they are not on (see [“Printer lights blink”](#) and [“Print cartridge problem”](#) for more information). Replace any low or empty print cartridges, then try to print again. See [“Replacing the print cartridges”](#) for instructions.

Printer lights blink



The Power light blinks when printing. This is normal.

The Power light blinks 2-on, 1-off when a print job is being cancelled.

When you see this...	The problem is likely caused by...
<p>Power light on and Resume light blinks</p>	<ul style="list-style-type: none"> • The printer is out of paper • The paper needs to be ejected • There is a paper size or type mismatch • The printer is no longer receiving data • The printer is waiting for the page to dry before printing the next page • Manual Duplex is waiting for user's action • There is a media size mismatch <p>See "Loading paper" and "Printing on standard-sized paper" for more information.</p>
<p>Power light on and Print Cartridge light blinks</p>	<ul style="list-style-type: none"> • Incompatible cartridge • Incorrect installation • Print cartridge damaged or not usable <p>See the print cartridge packaging to ensure that the print cartridge is designed for your printer model. For print cartridge installation instructions, see "Replacing the print cartridges."</p>
<p>Power and Print Cartridge lights on</p>	<ul style="list-style-type: none"> • Low or out of ink <p>Replace any low or empty print cartridges, then try to print again. See "Replacing the print cartridges" for instructions.</p>
<p>Power and Resume lights blink</p>	<p>The movement of the print cartridge might be blocked. Turn the printer off and open the printer's top cover to check the following:</p> <ul style="list-style-type: none"> • Remove any packing materials from the printer. • Check for paper that has crumpled and jammed in the printer. Remove the excess paper, then clear the paper jam from the rollers. See "Paper is jammed in the printer." <p>When there are no obstructions, turn the printer off, then on again.</p>
<p>Resume light blinks</p>	<p>There is a paper jam or paper motor stall. See "Paper is jammed in the printer."</p>
<p>All lights blink</p>	<p>Turn the printer off, then on again. If all the lights still blink, remove the printer's power plug from the wall outlet to completely cut off the power supply. If the problem persists, the problem is likely caused by a failure in the printer. Contact the HP Customer Support Center (see "Customer Support").</p>

Network printing problem

This section helps you to troubleshoot if you are having difficulties printing to a shared printer.

Check the following:

- Make sure the printer is on and the top cover is closed.
- Make sure the rear panel knob is in the lock position.
- Check that the cartridges are installed properly (see [“Replacing the print cartridges”](#)) and that paper is properly loaded in the printer (see [“Loading paper”](#)).
- Make sure the network cable and the printer cable connections are firmly in place.
- If the Resume button is blinking, press it and wait a few seconds for printing to start.
- If printing does not resume, check under the printer's top cover for a paper jam. See [“Paper is jammed in the printer”](#) for instructions on clearing paper jams.



Sharing the printer in mixed Mac and PC networking environments is not recommended.

After checking the printer, try to print a document from another client over the network.

If the document was sent from another client and printed successfully, your system settings are probably not configured properly to use this printer. Check with your system administrator to solve the problem.

If the document did not print successfully from another client:

- 1 Connect the printer to a PC that is running Windows.
- 2 Install the printer software if it is not previously installed in this PC.
- 3 Double-click the Toolbox icon on the desktop or in the printer's program group.
- 4 From the **Printer Services** tab, click **Print a Demo Page**.

If the demo page printed, your printer is working, but your network settings might not be configured correctly. Check with your network administrator for more information.

If the demo page did not print, this problem is likely caused by a failure in the printer or computer system. Call the HP Customer Support Center for help (see [“Customer Support”](#)).

Before calling, record your serial number and printer model, along with any information about your computer system that is available.

Uninstalling the printer software

For Windows:

- 1 Start Windows and make sure no other Windows applications are running.
- 2 Open Control Panel.
- 3 Double-click **Add/Remove Programs**.
- 4 Select **HP Deskjet 9300 series**.
- 5 Follow the onscreen instructions to complete the removal of the printer software.



You must have administrator privileges to uninstall the printer software in Windows NT 4.0, Windows 2000, and Windows XP.



If the software was not successfully installed, or the Uninstaller could not be found, run the scrubber utility from the Starter CD. For Windows 98 and Windows Me, use the scrub98.exe file located in the Windows\Utils\Scrubber\Win98_Me folder. For Windows 2000 and Windows XP, use the scrub2k.exe file located in the Windows\Utils\Scrubber\Win2K directory instead. Repeat the whole installation process again after this is done.

For Macintosh:

- 1 Restart the computer.



If you do not restart the computer before you uninstall the software, some files are not removed from your computer when you run the Uninstall option.

- 2 Insert the Starter CD into your CD-ROM drive and double-click the **CD icon** on the desktop.
- 3 Double-click the installer icon and follow the onscreen instructions.
- 4 When the Main Installation dialog box appears, select **Uninstall** from the drop-down list located in the upper-left part of the dialog box.
- 5 Follow the onscreen instructions to remove the printer software.

USB installation failed or nothing prints through USB

- If the installation failed, uninstall the driver and retry the installation.
- Check that your computer has a USB port and is properly configured to use USB.
- Check that your computer is running.
- Check that the USB cable is properly connected to the computer and the printer.
- Check that the printer is turned on.
- Connect the USB cable to the computer and printer, and turn on the printer. Verify that Windows is able to detect the printer. Windows will display the Found New Hardware wizard if it detects the printer.

Printer does not print after switching ports







Do not connect both the parallel cable and the USB cable to the printer simultaneously. Only use one type of connection to the printer at a time.

- Make sure the cable you are using is properly connected to the computer and the printer.
- Make sure the printer is off when you switch ports. If it was not off, turn the printer off, wait a few seconds, and then turn the printer on again.
- Check that the port setting matches the physical connection: Click **Start**, point to **Settings**, and then click **Printers** (Windows NT 4.0, 98, Me, and 2000) or **Printers and Faxes** (Windows XP). Right-click the printer icon and select **Properties**. Click the **Details** tab (Windows 98 and Me) or the **Ports** tab (Windows NT 4.0, 2000, and XP) and check the port setting.
- Print a test page: Click **Start**, point to **Settings**, and then click **Printers** (Windows NT 4.0, 98, Me, and 2000) or **Printers and Faxes** (Windows XP). Right-click the printer icon and select **Properties**. Click the **General** tab, and then click **Print Test Page**. If the test page prints, make sure the application you are trying to print from has the correct printer selected.

Print cartridge problem

When you open the printer's access cover, the yellow arrow on the print cartridge cradle aligns to one of the icons near the back of the printer. If the Print Cartridge Status light flashes, open the printer's access cover and follow the instructions below.

If the arrow points to...	It means...	To solve the problem...
Problem with color print cartridge 	The print cartridge is either: <ul style="list-style-type: none"> • missing • improperly installed • the wrong print cartridge for the printer • defective 	<ol style="list-style-type: none"> 1 Insert print cartridge if there is none. 2 Reinsert print cartridge if there is one. 3 If the above do not solve the problem, verify the color cartridge is an HP C6578 Series cartridge, and the black cartridge is an HP 51645 Series cartridge. 4 If the problem persists, replace the cartridge.
Problem with black print cartridge 		
Color print cartridge low on ink 	Color print cartridge is running low on ink.	Consider replacing the color cartridge with an HP C6578 Series cartridge.
Black print cartridge low on ink 	Black print cartridge is running low on ink.	Consider replacing the black cartridge with an HP 51645 Series cartridge.
Print cartridges OK 	Print cartridges are operational.	No problems.

Printing a sample page

Printing a sample page without being connected to a computer verifies whether your printer is set up correctly.

- 1 Turn the printer off, wait a few seconds, and then turn it on again by pressing the Power button.
- 2 Press and hold the Resume button and release it when the Resume light starts to blink. Your printer prints a sample page.

Printing a diagnostic page

This page is useful to HP Technical Support if you have a printer problem.

- 1 Turn the printer on.
- 2 While holding down the printer's Power button, press the printer's Resume button four times and then release the Power button.
- 3 The printer should print a diagnostic page. If the printer fails to print the diagnostic page, there is something wrong with the printer. Contact the HP Customer Care Center (see ["Customer Support"](#)).

Cancelling a print job

You can cancel a print job in two ways:

- Press the Cancel button on the front panel of the printer. The print job stops immediately.



Pressing the Cancel button clears the job currently being processed by the printer. It does not affect jobs waiting to be processed.

-Or-

- It is also possible to cancel print jobs in the print queue. See the Windows or Macintosh online help for more information.

6

Customer Support

The information in the previous chapter suggests solutions to common problems. If your printer is not operating properly and these suggestions do not solve your problem, try using one of the following support services to obtain assistance.

Toolbox



The Toolbox is available only if you installed the printer driver through Setup.exe.

The **Troubleshooting** tab in this program provides easy step-by-step solutions to common printing problems. You should be able to resolve most printing problems by following the provided solutions step-by-step. You can run this program by double-clicking the Toolbox icon on the desktop or in the program group.

hp instant support

hp instant support is a web-based tool that provides product-specific services, troubleshooting tips, and information about your printer's ink and media usage. You must have an Internet connection to use hp instant support.

To access hp instant support, select hp instant support in the Toolbox Information tab.



hp instant support web pages are dynamically created. Do not bookmark this site; always access it from the Toolbox.

World Wide Web

Visit our World Wide Web for the latest printer software, product, operating system, and support information at <http://www.hp.com/support/dj9300>.

HP telephone support

During the warranty period, you may obtain assistance from the HP Customer Care Center. For the number to call, see the support guide that came in the box with your printer.

To help our Customer Care Center representatives serve you better, have the following information ready before calling:

- 1 Print the printer diagnostic page (see ["Printing a diagnostic page"](#) for instructions). If the printer does not print, have the following information ready:
 - a model number and serial number (located at the back of the printer) such as C8136A and SG1881119P
 - b printer model such as HP Deskjet 9300, HP Business Inkjet 2600
- 2 Check the operating system you are using. For example, Windows 98 SE.
- 3 If the printer is connected to the network, check the network operating system. For example, Windows NT Server 4.0.
- 4 Note how the printer is connected to your system. For example, parallel, Universal Serial Bus (USB), or network.
- 5 Obtain the printer driver and version number of the printer software. For example, HP Deskjet 9300 PCL 3 version 1.0.
- 6 If you have a problem printing from a particular application, note the application and version number.



Printer specifications

Print Method	Drop-on-demand thermal inkjet printing		
Print Speed*: Black	Black text	Letter	Tabloid
	Fast	13 ppm	7.6 ppm
	Normal	7 ppm	4 ppm
	Best	4.5 ppm	3 ppm
Print Speed*: Color	Mixed text with color graphics	Letter	Tabloid
	Fast	11.5 ppm	7 ppm
	Normal	5.5 ppm	3.7 ppm
	Best	3.5 ppm	2 ppm
	Full-page color	Letter	Tabloid
	Fast	2.9 ppm	2 ppm
	Normal	0.6 ppm	0.4 ppm
	Best	0.3 ppm	0.2 ppm
	Color photo	4 by 6 in.	8 by 10 in.
	Normal	1.5 ppm	0.9 ppm
	Best	0.8 ppm	0.4 ppm
	Note*: Approximate figures. Exact speed depends on the system configuration, software program, and document complexity.		
Black Resolution	Fast	300 x 600 dpi	
	Normal	600 x 600 dpi	
	Best	600 x 600 dpi	
Color Resolution	Fast	300 x 600 dpi	
	Normal	600 x 600 dpi	
	Best	PhotoREt III	
	4800 x 1200 Optimized dpi*	4800 x 1200 dpi	
	Note*: Up to 4800 x 1200 Optimized dpi color printing on HP Premium Photo Papers and 1200 x 1200 input dpi.		
Printer Command Languages	HP PCL Level 3 enhanced		
Software Compatibility	Microsoft Windows (98, NT 4.0, Me, 2000, XP); Macintosh, MS-DOS applications		
Fonts	8 built-in fonts, 4 each in portrait and landscape orientations: CG Times, CG Times Italic; Courier, Courier Italic; Letter Gothic, Letter Gothic Italic; Univers, Univers Italic (Euro Symbol supported)		
Smart Software Features	In-box printer driver features: Symmetrical Margins, Emulate Laserjet Margins, Ink Volume Control, Custom Media Size, Resizing, Grayscale, HP Digital Photography, Tiling, Booklet, Pages per Sheet, Print on Both Sides, Banner, Mirror Image, Watermark*, Optimized for Fax, Print Preview*, Sepia*, Quick Sets*, ColorSync** Note: *Windows only; **Macintosh only		
Media Size	Standard US: Letter, Legal, Tabloid, Super B, Executive, Statement, Index Cards Standard International: A6, A5, A4, A3, A3+ Custom US: 4 by 6 in., 13 by 19 in. Custom Metric: 102 by 152 mm, 330 by 1,270 mm		
Media Type	Paper (plain, inkjet, photo, and banner), envelopes, transparencies, labels, iron-on transfers, greeting cards		

Media Handling	Main paper tray:	Sheets: up to 150, Envelopes: up to 15, Cards: up to 60
	Manual feed:	Single sheet only for thick paper, envelopes and cards
	Output tray capacity:	Up to 50 sheets
Recommended Media Weight	Paper: 60 to 135 g/m ² (16 to 36 lb bond) using primary path, and up to 280 g/m ² (74 lb bond) using rear manual feed Envelopes: 75 to 90 g/m ² (20 to 24 lb bond) Cards: 110 to 200 g/m ² (110 lb index) using manual feed	
I/O Interface	IEEE 1284-Centronics parallel compatible; Universal Serial Bus (Windows 98 and USB-connect Macintosh)	
Printer Memory	8 MB of built-in RAM	
Dimensions	With paper tray closed: 592.3 mm (23.3 in.) (W) by 233 mm (9.2 in.) H by 381 mm (15.0 in.) (D) With paper tray fully extended: 592.3 mm (23.3 in.) (W) by 233 mm (9.2 in.) H by 672 mm (26.5 in.) (D)	
Weight	10 kg (22 lb)	
Duty Cycle	5,000 pages/month	
Power Supply	Built-in Universal Power Supply	
Power Requirements	Power modules: Input voltage 100 to 240 VAC (±10 percent), 50/60 Hz (±3 Hz)	
Power Consumption	1 watt maximum when off; 11.3 watts maximum non-printing; 47.7 watts maximum when printing	
Operating Environment	Operating temperature: 5° to 40° C (41° to 104° F) Recommended operating conditions: 15° to 35° C (59° to 95° F) Storage temperature: -40° to 60° C (-40° to 140° F) Relative humidity: 20 to 80 percent RH non-condensing Noise levels per ISO 9296: Sound power LwAD: 5.8 B(A); Sound pressure LpAm: 47 dB(A) (By-stander position)	
System Requirements	Minimum Windows 98: P90 MHz, 16 MB RAM, 80 MB hard disk space Windows NT 4.0: P100 MHz, 32 MB RAM, 80 MB hard disk space Windows Me: P150 MHz, 32 MB RAM, 80 MB hard disk space Windows 2000: P300 MHz, 64 MB RAM, 80 MB hard disk space Windows XP: P233 MHz, 64 MB RAM, 80 MB hard disk space Mac OS 8.6.x: iMac 333 MHz or G3 350 MHz, 32 MB RAM Mac OS 9.x: iMac 333 MHz or G3 350 MHz, 32 MB RAM Mac OS X: G3 (except original PowerBook G3), 128 MB RAM Recommended Windows 98: P266 MHz, 32 MB RAM, 100 MB hard disk space Windows NT 4.0: P266 MHz, 64 MB RAM, 100 MB hard disk space Windows Me: P266 MHz, 32 MB RAM, 100 MB hard disk space Windows 2000: P300 MHz, 64 MB RAM, 100 MB hard disk space Windows XP: P300 MHz, 128 MB RAM, 100 MB hard disk space Mac OS 8.6.x: iMac 333 MHz or G3 350 MHz, 64 MB RAM Mac OS 9.x: iMac 333 MHz or G3 350 MHz, 64 MB RAM Mac OS X: G4 800 MHz, 256 MB RAM	
Warranty	1-year limited warranty	
Product Certifications	Safety Certifications: CCC S&E (China), CSA (Canada), PSB (Singapore), UL (USA), NOM-NYCE (Mexico), TUV-GS (Germany), KTL Mark (Korea), CE (European Union), B mark (Poland) EMC Certifications: FCC Title 47 CFR Part 15 Class B (USA), CTICK (Australia and New Zealand), CE (European Union), BSMI (Taiwan), GOST (Russia), ICES (Canada), MIC Mark (Korea)	

B

HP supplies and accessories

You can order HP supplies and accessories from the HP World Wide Web. Visit HPshopping.com (<http://www.hpshopping.com>) for more information.

Accessories

Parallel cable

HP IEEE-1284 A-B Parallel Cable (2 m) C2950A

HP IEEE-1284 A-B Parallel Cable (3 m) C2951A

USB cable

HP USB A-B (2 m) C6518A

Network interface

HP Jetdirect 170X external print server J3258A

HP Jetdirect 300X external print server J3263A

HP Jetdirect 175X external print server (USB) J6035A

HP Jetdirect 310X external print server (USB) J6038A

Supplies

Print cartridges

Black 51645G (21 ml) / 51645A (42 ml)

Color C6578D (19 ml) / C6578A (38 ml)

HP Bright White Inkjet Paper

A4, 500 sheets: 210 by 297 mm C1825A

A3, 200 sheets: 297 by 420 mm C1858A

HP Premium Inkjet Paper

A4, 200 sheets: 210 by 297 mm 51634Z

A3, 100 sheets: 297 by 420 mm C1856A

US Letter, 200 sheets: 8.5 by 11 in. 51634Y

US B-size, 100 sheets: 11 by 17 in. C1855A

HP Premium Heavyweight Inkjet Paper

A4, 100 sheets: 210 by 297 mm C1853A

HP Premium Photo Paper

A3, 15 sheets: 297 by 420 mm C6059A

US Letter, 15 sheets: 8.5 by 11 in. C6039A

HP Premium Plus Photo Paper

Glossy, A4, 20 sheets: 210 by 297 mm C6832A

Glossy, US Letter, 20 sheets: 8.5 by 11 in. C6831A

Glossy Snapshot, 20 sheets: 4 by 6 in. C6944A

Matte, A4, 20 sheets: 210 by 297 mm C6951A

Matte, US Letter, 20 sheets: 8.5 by 11 in. C6950A

HP Professional Brochure and Flyer Paper

Glossy, A4, 50 sheets: 210 by 297 mm C6818A

Glossy, US Letter, 50 sheets: 8.5 by 11 in. C6817A

Matte, US Letter, 50 sheets: 8.5 by 11 in. C6955A

Glossy, Tabloid, 50 sheets: 11 by 17 in. C6820A

Glossy, A3, 50 sheets: 297 by 420 mm C6821A

HP Premium Transparency Film

A4, 20 sheets: 210 by 297 mm C3832A

HP Banner Paper

A4, 100 sheets: 210 by 297 mm C1821A

HP Iron-on T-shirt Transfers

A4, 10 sheets: 210 by 297 mm C6050A

US Letter, 10 sheets: 8.5 by 11 in. C6049A

HP Greeting Card Paper

A4, 20 sheets, 20 envelopes C6042A

US Letter, 20 sheets, 20 envelopes C1812A

Glossy, A4, 10 sheets, 10 envelopes C6045A

Glossy, US Letter, 10 sheets, 10 envelopes C6044A

Felt-Textured, Ivory (half-fold), US Letter, 20 sheets, 20 envelopes C6828A

Regulatory information

FCC statement

The U.S. Federal Communications Commission (in 47 cfr 15.105) has specified that the following notices be brought to the attention of users of this product.

This device complies with part 15 of the FCC rules. Operation is subject to the following two conditions: (1) This device may not cause harmful interference, and (2) this device must accept any interference received, including interference that may cause undesired operation.

Shielded cables

Use of a shielded data cable is required to comply with the Class B limits of Part 15 of the FCC Rules.

Pursuant to Part 15.21 of the FCC Rules, any changes or modifications to this equipment not expressly approved by the Hewlett-Packard Company, may cause harmful interference and void the FCC authorization to operate this equipment.

NOTE: This equipment has been tested and found to comply with the limits for a Class B digital device, pursuant to Part 15 of the FCC Rules. These limits are designed to provide reasonable protection against harmful interference in a residential installation. This equipment generates, uses and can radiate radio frequency energy and, if not installed and used in accordance with the instructions, may cause harmful interference to radio communications. However, there is no guarantee that interference will not occur in a particular installation. If this equipment does cause harmful interference to radio or television reception, which can be determined by turning the equipment off and on, the user is encouraged to try to correct the interference by one or more of the following measures:

- Reorient or relocate the receiving antenna.
- Increase the separation between the equipment and receiver.
- Connect the equipment into an outlet on a circuit different from that to which the receiver is connected.
- Consult the dealer or an experienced radio/TV technician for help.

Power cord statement

The power cord cannot be repaired. If it is defective, it should be discarded or returned to the supplier.

LEDs classification

CLASS 1 LED PRODUCT
LED KLASSE 1
APPARECCHIO LED DI CLASSE 1
PRODUCT CLASY 1 Z DIODAMI (EWHECYCMILED)
Appareil à Diode Electruminescente de Classe 1
ZARIZENI LED TRIY 1
KLASS 1 LED APPARAT
LUOKAN 1 LED

Energy consumption



Energy Star is a US-registered service mark of United States Environmental Protection Agency.

사용자 안내문 (B급기기)

이 기기는 비업무용으로 전자파
장해검정을 받은 기기로서,
주거지역에서는 물론, 모든 지역에서
사용할 수 있습니다.

Regulatory model number

For regulatory identification purposes, your product is assigned a Regulatory Model Number. The Regulatory Model Number for your product is SNPRC-0305. The regulatory number should not be confused with the product name (such as HP Deskjet 9300) or product number (such as C8136A).

DECLARATION OF CONFORMITY

according to ISO/IEC Guide 22 and EN 45014



Manufacturer's Name: Hewlett-Packard Singapore (Pte) Ltd
Manufacturer's Address: Imaging & Printing Manufacturing Operations
20 Gul Way, Singapore 629196

declares, that the product

Product Name: HP® Deskjet 9300c
Model Number: C8136A
Regulatory Model Number: SNPRC-0305
Product Options: All

conforms to the following Product Specifications:

Safety: IEC 60950: 1999 / EN 60950: 2000
IEC 60825-1: 1993 + A1: 1997 + A2: 2001 / EN 60825-1: 1994 Class I for LEDs

EMC: CISPR 22: 1997 Class B / EN 55022: 1998 Class B
CISPR 24: 1997 / EN 55022: 1998

IEC 61000-3-2: 1995 / EN 61000-3-2: 1995
IEC 61000-3-3: 1994 / EN 61000-3-3: 1995

FCC Title 47 CFR, Part 15 Class B
AS / NZS 3548 / MIC-B / GB9254: 1998

Supplementary Information:

- (1) The product herewith complies with the requirements of the Low Voltage Directive 73/23/EEC and the EMC Directive 89/336/EEC, and carries the CE Marking accordingly.
- (2) The product was tested in a typical configuration with Hewlett Packard personal computer systems.
- (3) This Device complies with Part 15 of the FCC Rules. Operation is subject to the following two conditions: (1) this device may not cause harmful interference, and (2) this device must accept any interference received, including interference that may cause undesired operation.

Singapore, 21st Nov 2002.

Chan Kum Yew, Quality Manager

- **Australia Contact:** Product Regulations Manager, Hewlett-Packard Australia Ltd, 31-41 Joseph Street, Blackburn, Victoria 3133, Australia
- **European Contact:** Your Local Hewlett-Packard Sales and Service Office or Hewlett-Packard GmbH, Department, JIQ-TRE, Standards Europe, Herrenberger Strasse 140, D-71034 Boblingen (FAX: +49-7031-14-3143)
- **USA Contact:** Corporate Product Regulations Manager, Hewlett-Packard Company, 3000 Hanover Street, Palo Alto, CA 94304 (Phone: 415-857-1501)

Hewlett-Packard Limited Warranty Statement

HP product	Duration of Limited Warranty
Software	90 days
Accessories	90 days
Print cartridges	90 days
Printer peripheral hardware (see below for details)	1 year

Extent of Limited Warranty

- 1 Hewlett-Packard warrants to the end-user customer that the HP products specified above will be free from defects in materials and workmanship for the duration specified above, which duration begins on the date of purchase by the customer.
- 2 For software products, HP's limited warranty applies only to a failure to execute programming instructions. HP does not warrant that the operation of any product will be uninterrupted or error free.
- 3 HP's limited warranty covers only those defects that arise as a result of normal use of the product, and does not cover any other problems, including those that arise as a result of:
 - a Improper maintenance or modification;
 - b Software, media, parts, or supplies not provided or supported by HP;
 - c Operation outside the product's specifications;
 - d Unauthorized modification or misuse.
- 4 For HP printer products, the use of a non-HP print cartridge or a refilled print cartridge does not affect either the warranty to the customer or any HP support contract with the customer. However, if printer failure or damage is attributable to the use of a non-HP or refilled print cartridge, HP will charge its standard time and materials charges to service the printer for the particular failure or damage.
- 5 If HP receives, during the applicable warranty period, notice of a defect in any product which is covered by HP's warranty, HP shall either repair or replace the product, at HP's option.
- 6 If HP is unable to repair or replace, as applicable, a defective product which is covered by HP's warranty, HP shall, within a reasonable time after being notified of the defect, refund the purchase price for the product.
- 7 HP shall have no obligation to repair, replace, or refund until the customer returns the defective product to HP.
- 8 Any replacement product may be either new or like new, provided that it has functionality at least equal to that of the product being replaced.
- 9 HP products may contain remanufactured parts, components, or materials equivalent to new in performance.
- 10 HP's Limited Warranty Statement is valid in any country/region where the covered HP product is distributed by HP. Contracts for additional warranty services, such as on-site service, are available from any authorized HP service facility in countries/regions where the product is distributed by HP or by an authorized importer.

Limitations of Warranty

TO THE EXTENT ALLOWED BY LOCAL LAW, NEITHER HP NOR ITS THIRD-PARTY SUPPLIERS MAKES ANY OTHER WARRANTY OR CONDITION OF ANY KIND, WHETHER EXPRESS OR IMPLIED WARRANTIES OR CONDITIONS OF MERCHANTABILITY, SATISFACTORY QUALITY, AND FITNESS FOR A PARTICULAR PURPOSE.

Limitations of Liability

- 1 To the extent allowed by local law, the remedies provided in this Warranty Statement are the customer's sole and exclusive remedies.
- 2 TO THE EXTENT ALLOWED BY LOCAL LAW, EXCEPT FOR THE OBLIGATIONS SPECIFICALLY SET FORTH IN THIS WARRANTY STATEMENT, IN NO EVENT SHALL HP OR ITS THIRD-PARTY SUPPLIERS BE LIABLE FOR DIRECT, INDIRECT, SPECIAL, INCIDENTAL, OR CONSEQUENTIAL DAMAGES, WHETHER BASED ON CONTRACT, TORT, OR ANY OTHER LEGAL THEORY AND WHETHER ADVISED OF THE POSSIBILITY OF SUCH DAMAGES.

Local Law

- 1 This Warranty Statement gives the customer specific legal rights. The customer may also have other rights which vary from state to state in the United States, from province to province in Canada, and from country/region to country/region elsewhere in the world.
- 2 To the extent that this Warranty Statement is inconsistent with local law, this Warranty Statement shall be deemed modified to be consistent with such local law. Under such local law, certain disclaimers and limitations of this Warranty Statement may not apply to the customer. For example, some states in the United States, as well as some governments outside the United States (including provinces in Canada), may:
 - a Preclude the disclaimers and limitations in this Warranty Statement from limiting the statutory rights of a customer (e.g., the United Kingdom);
 - b Otherwise restrict the ability of a manufacturer to enforce such disclaimers or limitations; or
 - c Grant the customer additional warranty rights, specify the duration of implied warranties which the manufacturer cannot disclaim, or allow limitations on the duration of implied warranties.
- 3 FOR CONSUMER TRANSACTIONS IN AUSTRALIA AND NEW ZEALAND, THE TERMS IN THIS WARRANTY STATEMENT, EXCEPT TO THE EXTENT LAWFULLY PERMITTED, DO NOT EXCLUDE, RESTRICT, OR MODIFY, AND ARE IN ADDITION TO, THE MANDATORY STATUTORY RIGHTS APPLICABLE TO THE SALE OF THE HP PRODUCTS TO SUCH CUSTOMERS.

Index

Numerics

4800 x 1200 Optimized dpi 3-8, A-1

A

access cover 2-1
accessories
 ordering information B-1
 warranty

C

Cancel button 2-1
cancelling print job 5-13
cards, printing 3-6
customer support 6-1
custom-sized paper, printing 3-5

D

declaration of conformity
demo page, printing 4-3
diagnostic page, printing 5-13
dimensions, printer A-2
drivers, warranty
duplex. *See* two-sided printing

E

envelopes, printing 3-6
environmental specifications A-2
error messages
 displaying via Toolbox 4-1

F

FCC statement
fonts, included A-1

H

help
 customer support 6-1
 hp instant support 6-1
 HP telephone support 6-1
 Toolbox 4-1, 6-1
 website 6-1
HP Deskjet Control Panel for DOS 2-8
HP Inkjet Utility 4-3
hp instant support 1-1, 4-1, 6-1
HP Jetdirect external print server 2-4
HP media, printing 3-4
HP PCL 3 A-1
HP telephone support 6-1
hpshopping.com B-1

I

I/O interfaces A-2
Information tab, Toolbox 4-1
interfaces, I/O A-2

J

jammed paper 5-3

L

language, printer A-1

limited warranty
loading paper
 main paper tray 3-1
 rear manual feed 3-2

M

Macintosh
 HP Inkjet Utility 4-3
 system requirements A-2
main paper tray 2-1, 3-1
manual feed, rear 2-1, 3-2
margins, minimum printing 3-3
media
 handling specifications A-2
 loading 3-1
 ordering supplies B-1
 printing on cards 3-6
 printing on custom-sized paper 3-5
 printing on envelopes 3-6
 printing on HP media 3-4
 printing on photo paper 3-7
 printing on standard-sized paper 3-5
 printing on thick plain paper 3-7
 printing on transparencies 3-3
 size specifications A-1
 types supported 3-1, A-1
 weight specifications A-2
memory, included A-2
minimum printing margins 3-3
MS-DOS, printing 2-8
myPrintMileage
 accessing via Toolbox 4-1
 description 4-2

N

network printing 2-4

O

operating system requirements A-2
output tray 2-1

P

paper guides 2-1
paper jams
 clearing 5-3
 tips for avoiding 5-3
paper. *See* media
parallel port 2-1
parts, printer 2-1
PCL language, included A-1
photo paper, printing 3-7
postcard guide 2-1
Power button 2-1
power input 2-1
print cartridge icons 5-12
Print Cartridge light 2-1
print cartridges
 aligning 2-7, 4-3
 cleaning 2-7, 4-3
 ink level display, Toolbox 4-1
 replacing 2-6
 warranty

- print server, connecting 2-5
- print speed A-1
- printer
 - display hardware information 4-1
 - language A-1
 - lights blink 5-9
 - memory A-2
 - model number, locating 6-1
 - parts and functions 2-1
 - registering via Toolbox 4-1
 - serial number, locating 6-1
 - smart software features 3-9
 - specifications A-1
- printer driver
 - accessing 2-6
 - aligning print cartridges 2-7
 - smart software features 3-9, A-1
 - system requirements A-2
 - uninstalling 5-10
 - warranty
- Printer Services tab, Toolbox 4-3
- Printer Status tab, Toolbox 4-1
- printing
 - cancelling print job 5-13
 - minimum margins 3-3
 - on cards 3-6
 - on custom-sized paper 3-5
 - on envelopes 3-6
 - on HP media 3-4
 - on photo paper 3-7
 - on standard-sized paper 3-5
 - on thick plain paper 3-7
 - on transparencies 3-3
- product certifications A-2

R

- rear manual feed 2-1, 3-2
- regulatory information
- removable panel 2-1
- removable panel knob 2-1
- resolution, printer A-1
- Resume button 2-1

S

- safety information
- sample page, printing 5-13
- software
 - hardware-first installation 2-3
 - installing in Windows 2-2
 - smart software features 3-9
 - software-first installation 2-2
 - system requirements A-2
 - uninstalling 5-10
 - warranty
- specifications
 - operating environment A-2
 - power consumption A-2
 - power requirements A-2
 - printer A-1
 - printer duty cycle A-2
 - printer size A-2
 - printer weight A-2
- standard-sized paper, printing 3-5
- Starter CD 1-1
- supplies and accessories
 - ordering information B-1
- system requirements A-2

T

- test page, printing 5-2

- thick plain paper, printing 3-7

Toolbox

- description 1-1
- help 6-1
- Information tab 4-1
- Printer Services tab 4-3
- Printer Status tab 4-1
- using 4-1

- transparencies, printing 3-3
- troubleshooting
 - blank page ejected 5-3
 - diagnostic page, printing 5-13
 - incorrect text or graphics placement 5-7
 - jammed paper 5-3
 - missing text or images 5-6
 - network printing problem 5-10
 - nothing prints 5-1
 - paper feed problem 5-2
 - paper skew problem 5-3
 - poor print quality 5-4
 - power cannot be turned on 5-1
 - print cartridge problem 5-12
 - printer lights blink 5-9
 - sample page, printing 5-13
 - slow printing 5-8
 - switching ports problem 5-11
 - test page, printing 5-2
 - unexpected results 5-6
 - USB fails 5-11
- two-sided printing 3-8
- typefaces, included A-1

U

- USB port 2-1

W

- warranty
- website
 - myPrintMileage 4-2
 - ordering supplies and accessories B-1
 - printer 1-1, 2-8, 6-1
- Windows
 - system requirements A-2