

User Manual 20" LCD



AP-20

Aluminum front bezel

NAP-20

Front NEMA4 / IP65



OP-20

Universal Mounting Open Frame



REACH

Designed and manufactured by Austin Hughes

Legal Information

First English printing, October 2002

Information in this document has been carefully checked for accuracy; however, no guarantee is given to the correctness of the contents. The information in this document is subject to change without notice. We are not liable for any injury or loss that results from the use of this equipment.

Safety Instructions

Please read all of these instructions carefully before you use the device. Save this manual for future reference.

- Unplug equipment before cleaning. Don't use liquid or spray detergent; use a moist cloth.
- Keep equipment away from excessive humidity and heat. Preferably, keep it in an air-conditioned environment with temperatures not exceeding 40° Celsius (104° Fahrenheit).
- When installing, place the equipment on a sturdy, level surface to prevent it from accidentally falling and causing damage to other equipment or injury to persons nearby.
- When the equipment is in an open position, do not cover, block or in any way obstruct the gap between it and the power supply. Proper air convection is necessary to keep it from overheating.
- Arrange the equipment's power cord in such a way that others won't trip or fall over it.
- If you are using a power cord that didn't ship with the equipment, ensure that it is rated for the voltage and current labeled on the equipment's electrical ratings label. The voltage rating on the cord should be higher than the one listed on the equipment's ratings label.
- Observe all precautions and warnings attached to the equipment.
- If you don't intend on using the equipment for a long time, disconnect it from the power outlet to prevent being damaged by transient over-voltage.
- Keep all liquids away from the equipment to minimize the risk of accidental spillage. Liquid spilled on to the power supply or on other hardware may cause damage, fire or electrical shock.
- Only qualified service personnel should open the chassis. Opening it yourself could damage the equipment and invalidate its warranty.
- If any part of the equipment becomes damaged or stops functioning, have it checked by qualified service personnel.

What the warranty does not cover

- Any product, on which the serial number has been defaced, modified or removed.
- Damage, deterioration or malfunction resulting from:
 - Accident, misuse, neglect, fire, water, lightning, or other acts of nature, unauthorized product modification, or failure to follow instructions supplied with the product.
 - Repair or attempted repair by anyone not authorized by us.
 - Any damage of the product due to shipment.
 - Removal or installation of the product.
 - Causes external to the product, such as electric power fluctuation or failure.
 - Use of supplies or parts not meeting our specifications.
 - Normal wear and tear.
 - Any other causes which does not relate to a product defect.
- Removal, installation, and set-up service charges.

Regulatory Notices Federal Communications Commission (FCC)

This equipment has been tested and found to comply with the limits for a Class B digital device, pursuant to Part 15 of the FCC rules. These limits are designed to provide reasonable protection against harmful interference in a residential installation.

Any changes or modifications made to this equipment may void the user's authority to operate this equipment. This equipment generates, uses, and can radiate radio frequency energy and, if not installed and used in accordance with the instructions, may cause harmful interference to radio communications.

However, there is no guarantee that interference will not occur in a particular installation. If this equipment does cause harmful interference to radio or television reception, which can be determined by turning the equipment off and on, the user is encouraged to try to correct the interference by one or more of the following measures:

- Re-position or relocate the receiving antenna.
- Increase the separation between the equipment and receiver.
- Connect the equipment into an outlet on a circuit different from that to which the receiver is connected.

Contents

< Part. 1 > AP-20 / NAP-20

1.1	Package Content	P.1
1.2	Structure Diagram & Dimension	P.2 - 3
1.3	Mounting Hardware & Installation	P.4 - 5

< Part. 2 > OP-20

2.1	Package Content	P.6
2.2	Structure Diagram & Dimension	P.7 - 8
2.3	Mounting Hardware & Installation	P.9

< Part. 3 > Specifications / OSD

3.1	Product Specifications	P.10 - 11
3.2	On-screen Display Operation (OSD)	P.12

< Part. 4 > Options

4.1	Option Table	P.13
4.2	3G / HD / SD- SDI Broadcast-grade input	P.14
4.3	MCS Multi-display control solution	P.15
4.4	AV2.2D Upgrade : DVI-D, S-Video + BNC & Audio AV2.2H Upgrade : HDMI, S-Video + BNC & Audio	P.16 - 17
4.5	AV3.0 Upgrade : HDMI, DVI-D, S-Video + BNC & Audio	P.18
4.6	Resistive (single point touch)	P.19 - 20
4.7	DC Power : 12V / 24V / 48V / 110 ~ 125V	P.21
4.8	MIL-type or lockable connector	P.22
4.9	Quad display for CCTV	P.23
4.10	TV (Analog)	P.24 - 25

Before Installation

- It is very important to mount the equipment in a suitable cabinet or on a stable surface.
- Make sure the place has a good ventilation, is out of direct sunlight, away from sources of excessive dust, dirt, heat, water, moisture and vibration.

Unpacking

The equipment comes with the standard parts shown in package content. Check and make sure they are included and in good condition. If anything is missing, or damaged, contact the supplier immediately.

How To Clean Your LCD Monitor



Caution :

- To avoid the risk of electric shock, make sure your hands are dry before unplugging your monitor from or plugging your monitor into an electrical outlet.
- When you clean your monitor, do not press down on the LCD screen. Pressing down on the screen can scratch or damage your display. Pressure damage is not covered under warranty.
- Use only cleansers made specifically for cleaning monitors and monitor screens. Cleansers not made to clean monitors and monitor screens can scratch the LCD display or strip off the finish.
- Do not spray any kind of liquid directly onto the screen or case of your monitor. Spraying liquids directly onto the screen or case can cause damage which is not covered under warranty.
- Do not use paper towels or abrasive pads to clean your monitor. Using an abrasive pad or any wood based paper product such as paper towels can scratch your LCD screen.

Cleaning Your Monitor

To clean your LCD safely, please follow these steps :

- ① Disconnect the power cord.
- ② Gently wipe the surface using a clean, dry microfiber cloth. Use as little pressure as possible.

Cleaning Tough Marks and Smudges

To remove tough marks and smudges, please follow these steps :

- ① Disconnect the power cord.
- ② Spray a small amount of non-abrasive cleanser on a microfiber cloth.



Caution : Do not spray or apply any liquids directly onto the monitor. Always apply the solution to your microfiber cloth first, not directly on the parts you are cleaning.

- ③ Gently wipe the surface. Use as little pressure as possible.
- ④ Wait until your monitor is completely dry before plugging it in and powering it up.

< Part 1 >

< 1.1 > Package Content - AP / NAP-20

AP-20 / NAP-20



20" LCD display X 1

6ft VGA cable X 1

Power adapter X 1

Power cord X 1

Mounting hardware X 1 pack

- Mounting bracket x 4 pcs

- M4* 6mm screw x 8 pcs

- M4* 50mm screw x 8 pcs

Basic I/O

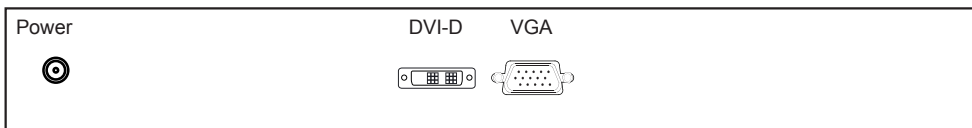

AV2.2D upgrade I/O

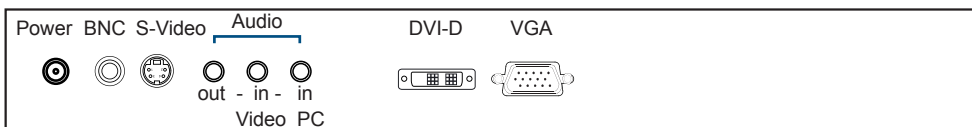

AV2.2H upgrade I/O

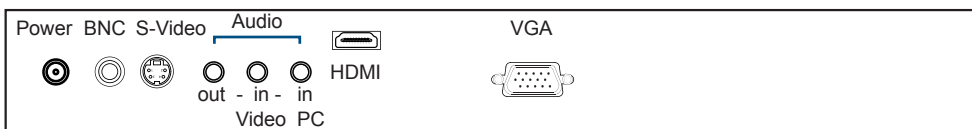

AV3.0 upgrade I/O with advanced features

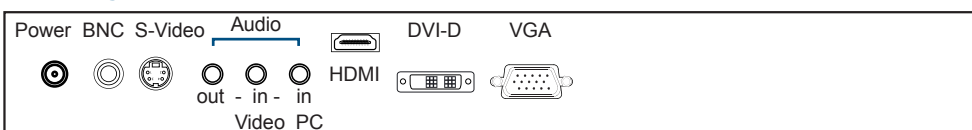

- An abundance of input connections that include HDMI, DVI-D, VGA, S-Video + BNC and audio
- On-chip Faroudja® DCDi Cinema processing
- Casing dimensions will be changed

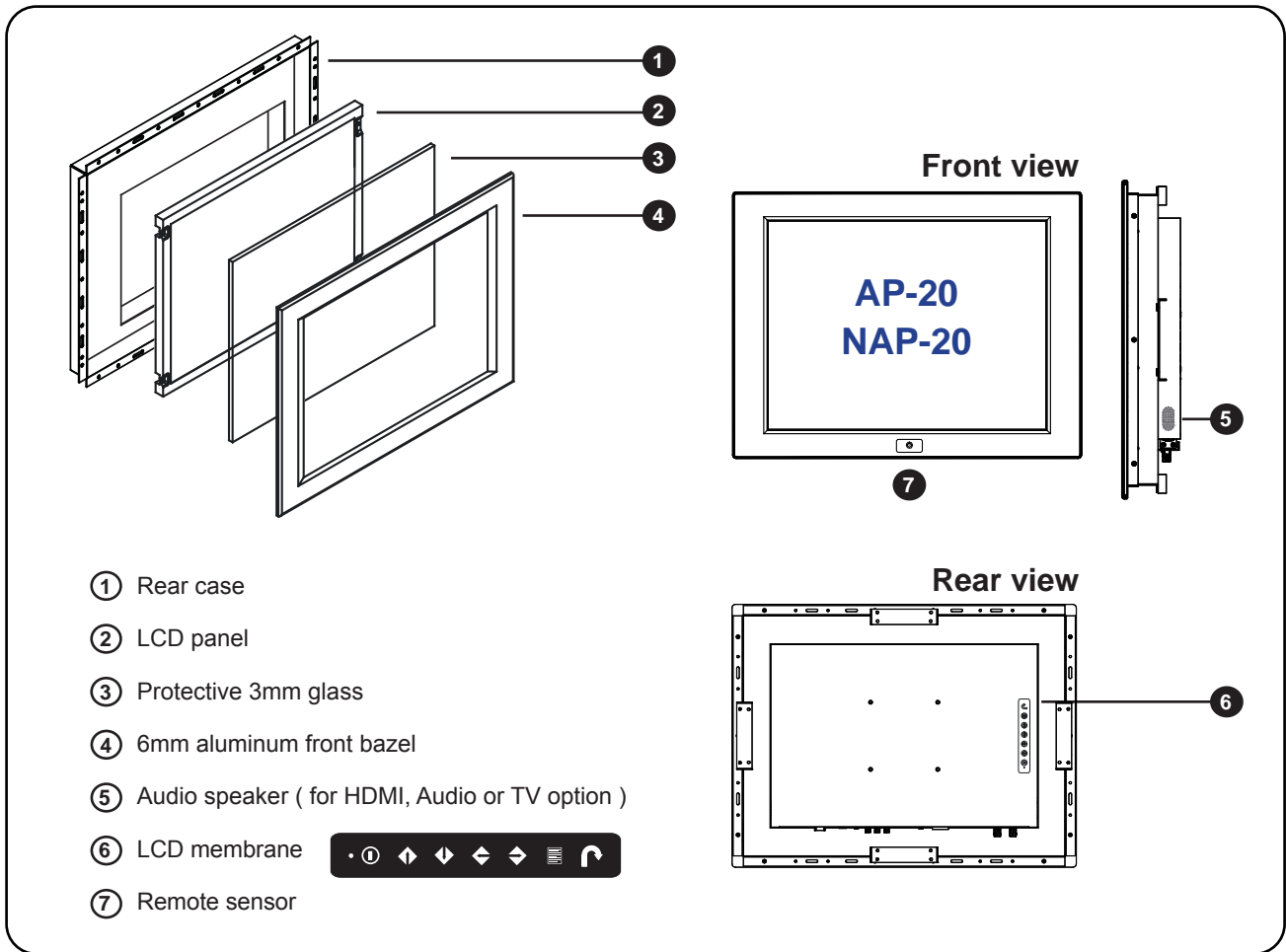

Model	Product Dimension (W x D x H)	Packing Dimension (W x D x H)	Net Weight	Gross Weight
AP-20 NAP-20	512.5 x 72.1 x 391.6 mm 20.2 x 2.8 x 15.4 inch	651 x 124 x 597 mm 25.6 x 4.9 x 23.5 inch	6 kg 13.2 lbs	8 kg 17.6 lbs

< 1.2 > Dimension - AP / NAP-20

Front View

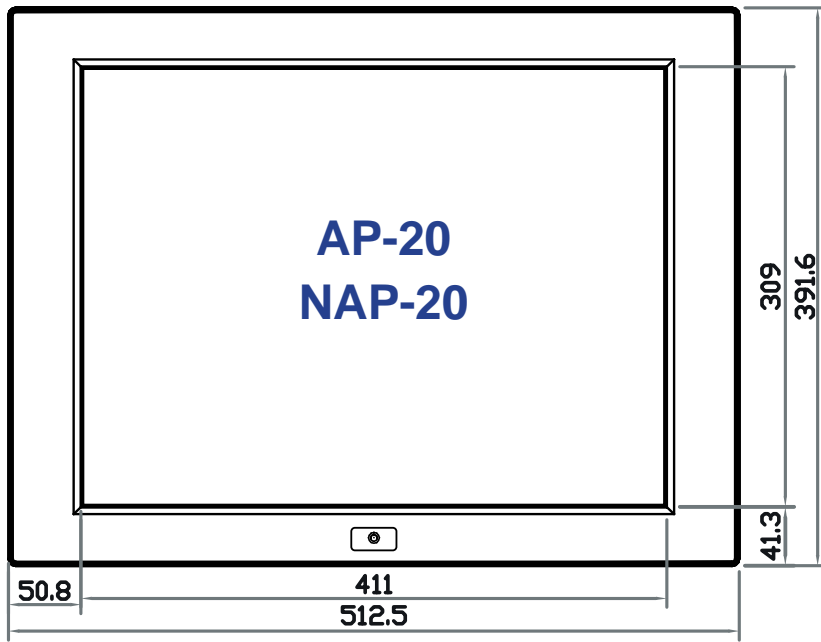

Side View

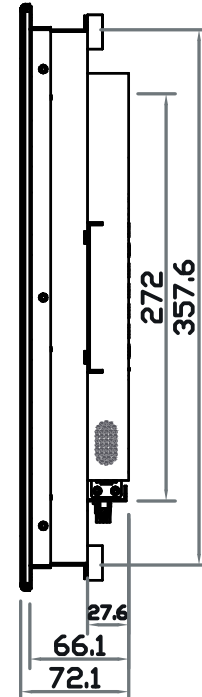

Rear View

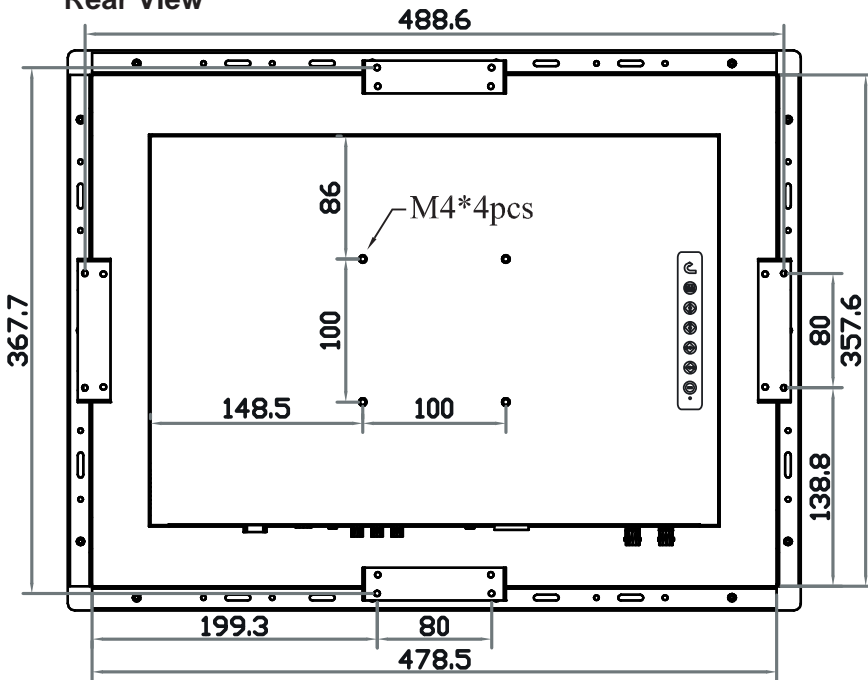

UNIT : mm
1mm = 0.03937 inch

Bottom View

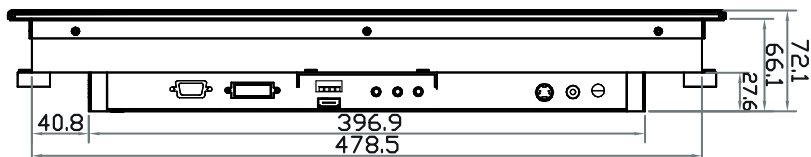

< 1.3 > Panel Mount Installation - AP / NAP-20

20" LCD Display

- 1 Mounting bracket
x 4 pcs

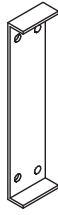

- 2 M4*6mm screw
x 8 pcs



- 3 M4*50mm screw
x 8 pcs

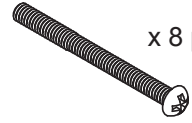

Hardware set part no. UV-BK#2

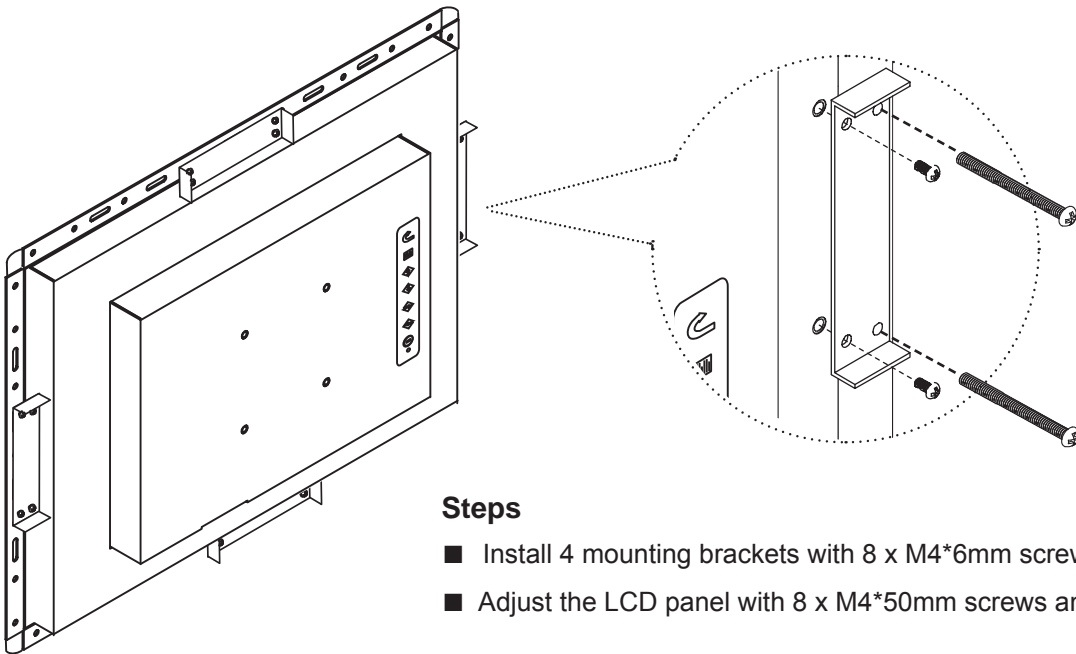

Steps

- Install 4 mounting brackets with 8 x M4*6mm screws
- Adjust the LCD panel with 8 x M4*50mm screws and fix it on the surface.

< 1.3 > VESA mount Installation - AP / NAP-20

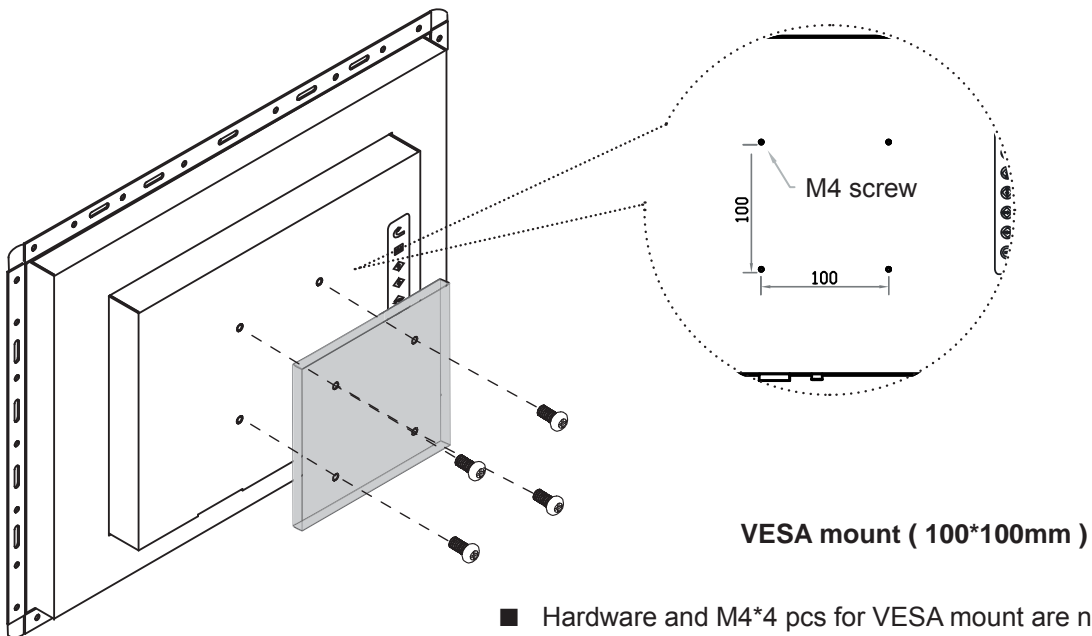

OP-20



- 20" LCD display X 1
- 6ft VGA cable X 1
- Power adapter X 1
- Power cord X 1

Basic I/O

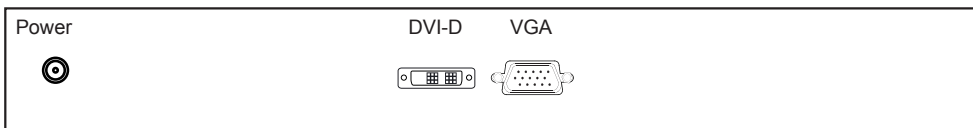

AV2.2D upgrade I/O

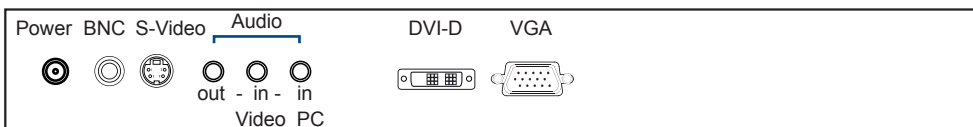

AV2.2H upgrade I/O

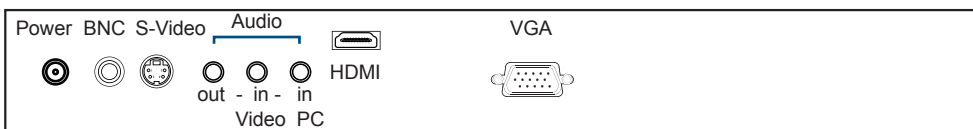

AV3.0 upgrade I/O with advanced features

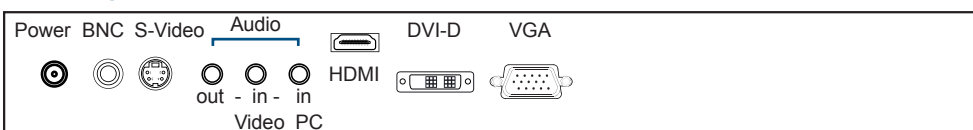

- An abundance of input connections that include HDMI, DVI-D, VGA, S-Video + BNC and audio
- On-chip Faroudja® DCDi Cinema processing
- Casing dimensions will be changed

< 2.2 > Structure Diagram - OP-20

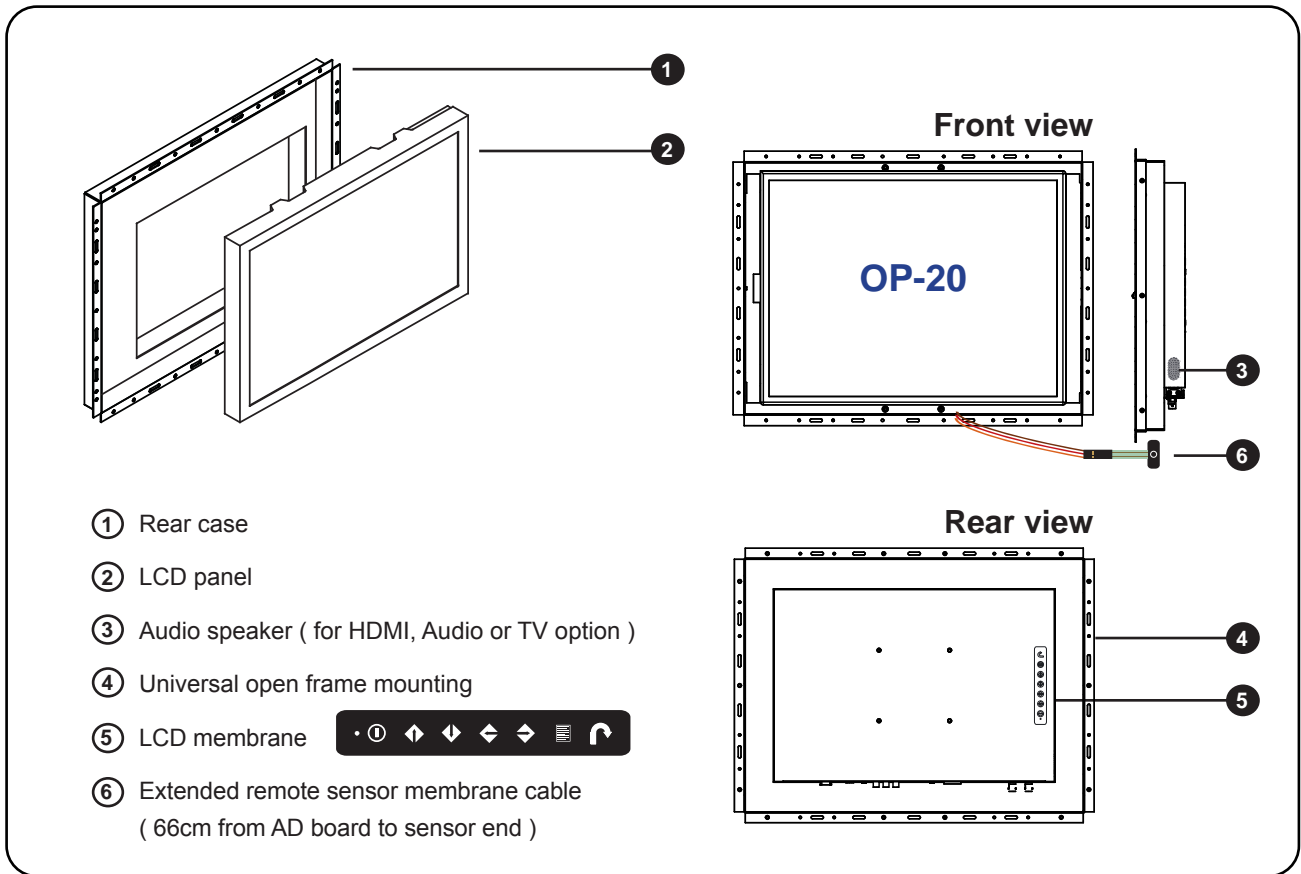

Model	Product Dimension (W x D x H)	Packing Dimension (W x D x H)	Net Weight	Gross Weight
OP-20	509.5 x 66.1 x 388.6 mm 20.1 x 2.6 x 15.3 inch	651 x 124 x 597 mm 25.6 x 4.9 x 23.5 inch	6 kg 13.2 lbs	8 kg 17.6 lbs

< 2.2 > Dimension - OP-20

20" LCD Display

Front View

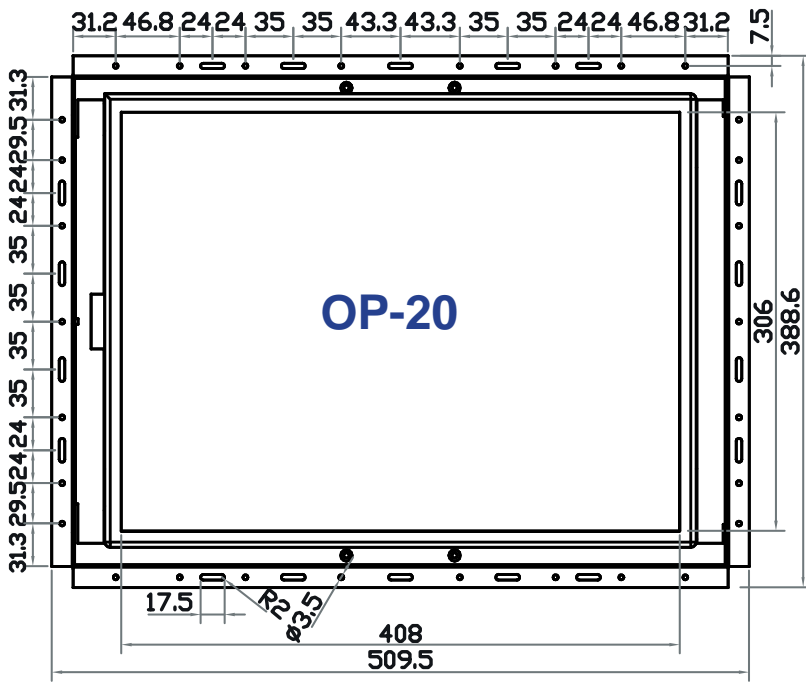

Side View

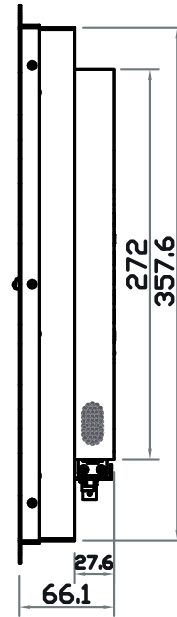

Rear View

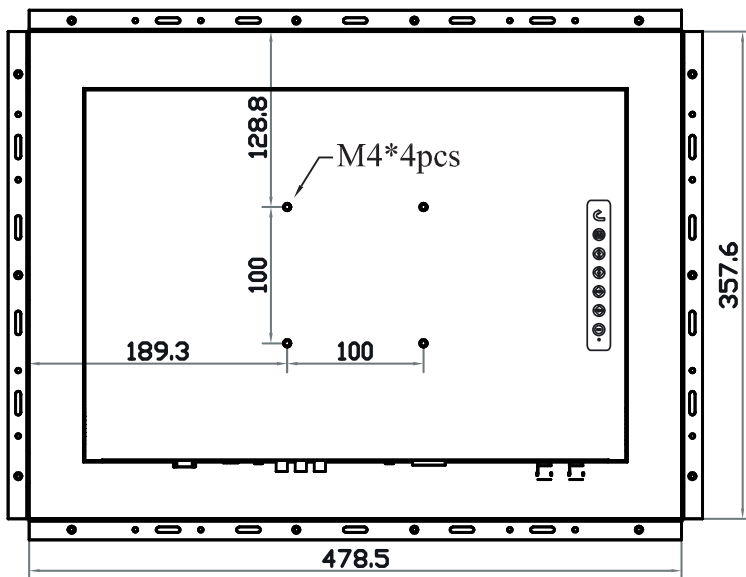

UNIT : mm
1mm = 0.03937 inch

Bottom View

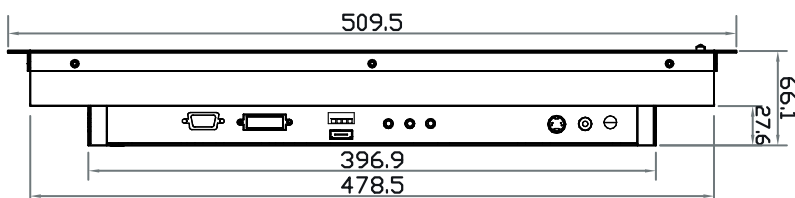

< 2.3 > Installation - OP-20

(I) Universal mount

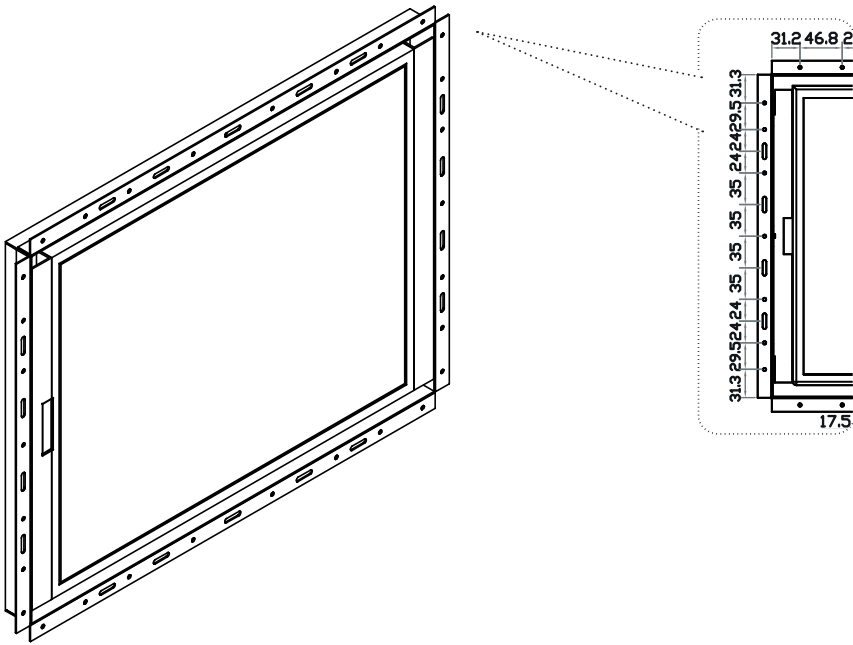

(II) VESA mount (100*100mm)

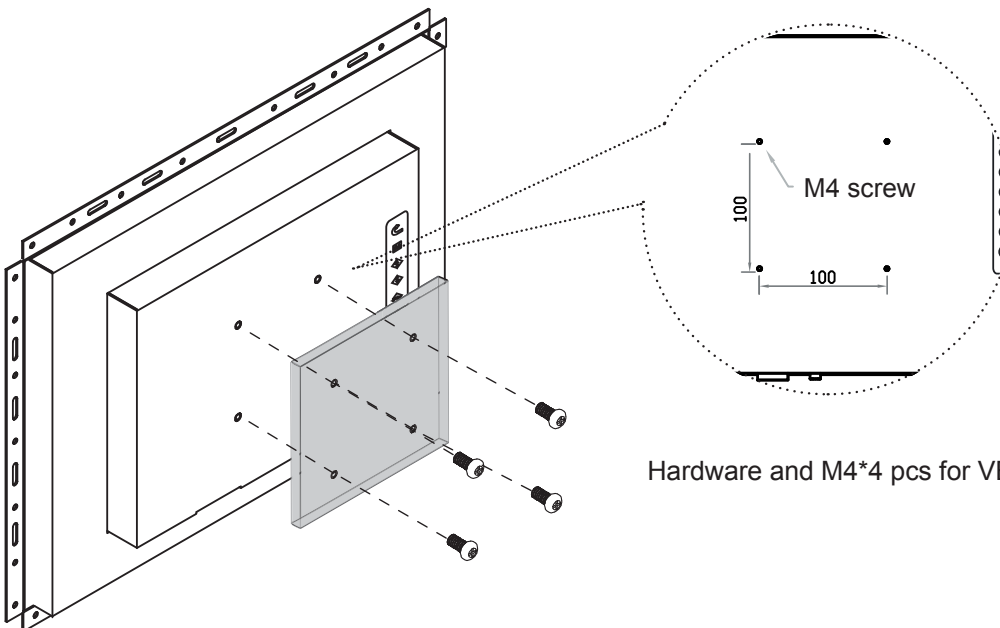

Hardware and M4*4 pcs for VESA mounting are not provided

< Part 3 >

< 3.1 > Product Specifications

20" LCD Display

Mechanical Design		AP / NAP-20	OP-20
	Front Panel	Black, RAL 9005	-
	Rear Casing	Black, RAL 9005	Black, RAL 9005
	VESA Mounting	100 x 100mm	100 x 100mm
	Other Mounting	Panel mount	Universal mount
Protection	3mm protective glass	-	

LCD Panel	Manufacturer	 LG
	Panel Size (diagonal)	20-inch TFT color LCD
	Display pixel (dots x lines)	1600 x 1200
	Brightness (typ.)	300
	Contrast Ratio (typ.)	800:1
	Color	16.7 M
	Viewing Angle (L/R/U/D)	89/89/89/89
	Response Time (ms)	16
	Dot pitch (mm)	0.255
	Display Area (mm)	408.00H x 306.00V
	Surface treatment	Anti-glare, Hard-coating
	Surface hardness	3H
	Backlight Type	CCFL
MTBF (hrs)	45,000	

Video Connectivity	Analog	VGA	Analog 0.7Vp-p
		DVI-D	DVI-D, TMDS single link

Power	Power Supply	Range	Auto-sensing 100 to 240VAC, 50/60Hz
	Power Consumption	Screen display ON	48W or less
		Power saving mode	4W or less
		Power button OFF	1W or less

Regulatory	Safety	FCC & CE certified
	Environmental	RoHS2 & REACH compliant

Environmental Conditions	Operating	Temperature	0 to 55°C degree
		Humidity	20~90%, non-condensing
	Storage	Temperature	-5 to 60°C degree
		Humidity	5~90%, non-condensing
		Shock	10G acceleration (11ms duration)
		Vibration	5~500Hz 1G RMS random

Physical Specification		AP / NAP-20	OP-20
	Product (W x D x H)	512.5 x 72.1 x 391.6 mm 20.2 x 2.8 x 15.4 inch	509.5 x 66.1 x 388.6 mm 20.1 x 2.6 x 15.3 inch
	Packing (W x D x H)	651 x 124 x 597 mm 25.6 x 4.9 x 23.5 inch	651 x 124 x 597 mm 25.6 x 4.9 x 23.5 inch
	Net Weight	6 kgs / 13.2 lbs	6 kgs / 13.2 lbs
	Gross Weight	8 kgs / 17.6 lbs	8 kgs / 17.6 lbs

Applicable Format	VGA Input	PC Signal	1600 x 1200 x 60Hz
			1400 x 1050 x 60Hz
			1440 x 900 x 60Hz
			1360 x 768 x 60Hz
			1280 x 1024 x 60 / 75Hz
			1280 x 960 x 60Hz
			1280 x 760 x 60 / 75Hz
			1152 x 864 x 75Hz
			1024 x 768 x 60 / 70 / 75Hz
			848 x 480 x 60Hz
			800 x 600 x 60 / 72 / 75Hz
			720 x 400 x 70Hz
			640 x 480 x 60 / 72 / 75Hz
			640 x 400 x 70Hz
640 x 350 x 70Hz			

- Power light
- Green = On
- Orange = Power saving

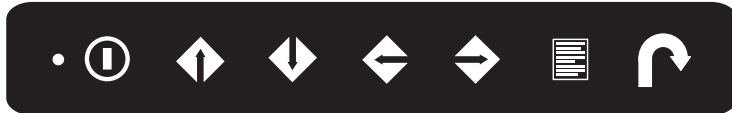

Membrane Switch	Function
	Power on / off LCD
	Display the OSD menu
	Scrolls through menu options and adjusts the displayed control (To auto adjustment by pressing the button for 5 seconds)
	Exit the OSD screen Toggle analog, digital & video connection (DVI-D and video options only)

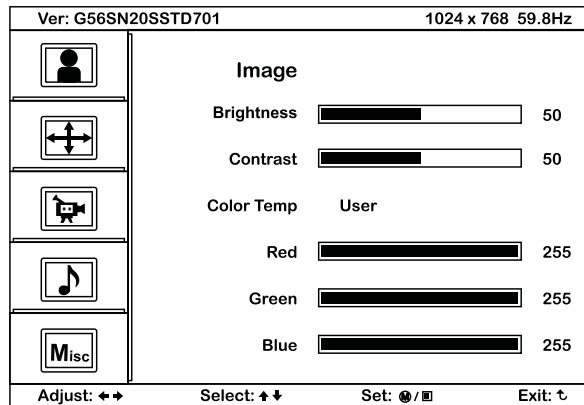

OSD Configuration Page



Image:
for the brightness, contrast, color temp, red, green, and blue

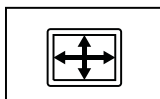

Geometry:
for the auto adjust, H position, V position, phase and clock



Video:
for the colour, tint, sharpness, noise reduction, DCDi and TV Setup



Audio:
for volume, bass, treble, balance, AVL and mute



Misc:
for the language, OSD position, graphic mode, ratio, reset and timer

< Part 4 > Options

< 4.1 > Option Table

Options	AP / NAP	OP
SDI ***	✓	✓
HDMI * or DVI-D	✓	✓
S-Video * + Composite (BNC)	✓	✓
Audio	✓	✓
Touchscreen	✓	✓
MCS multi-display control	✓	✓
DC Power	✓	✓
MIL-type / lockable connector	✓	✓
Quad display	✓	✓
TV (Analog) *	✓	✓



*** About SDI

(1) The AD board will be upgraded to version 3.0, and this comes standard with HDMI, DVI-D, VGA, S-Video, BNC, audio inputs and RC-1 remote controller.

* About HDMI and DVI-D

(1) For AV2.2 upgrade, either HDMI or DVI-D is provided.

(2) If the user needs HDMI and DVI-D, AV3.0 upgrade can be applied.

* Remote Controller

(1) AV2.2 upgrade comes with RC-1 remote controller.

(2) TV option comes with RC-2 remote controller.

< 4.2 > Options : 3G / HD / SD-SDI input

20" LCD Display



Austin Hughes' SDI input is an ideal solution for the broadcast-grade video and high resolution CCTV market.

Designed for use with UltraView Full HD 1080p and ultra high resolution 1920 x 1200 LCD displays, Austin Hughes provides a SDI input module without using additional space or power and it comes standard with a 2-year warranty.

SDI

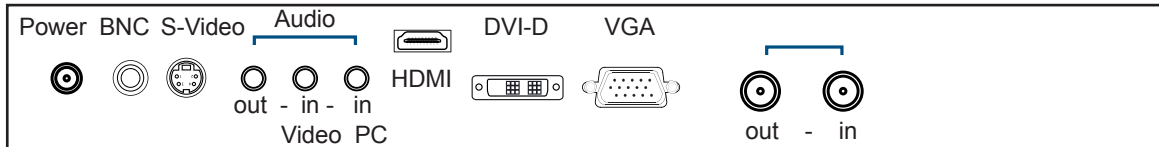

*** For **SDI** option, the AD board will be upgraded to AV3.0, and this comes standard with HDMI, DVI-D, VGA, S-Video, BNC, audio inputs and RC-1 remote controller (please refer to P.17). Casing dimensions will be changed.

INPUT	3G-SDI IN	BNC x 1 / 0.8Vp-p (75 ohm)
	3G-SDI OUT	BNC x 1 / Active through, equalized & relocked

Standard Compliance	Video	SMPTE 425M / 274M / 296M / 125M ITU-R BT.656
	Audio	SMPTE 299M / 272M-C

Compatible Video Format	3G-SDI	1080p @60 / 50Hz, 4:2:2 1080p @30 / 25 / 24Hz, 4:4:4 1080i @60 / 50Hz, 4:4:4 720p @60 / 50Hz, 4:4:4
	HD-SDI	1080p @30 / 25 / 24Hz, 4:2:2 1080i @60 / 50Hz, 4:2:2 720p @60 / 50Hz, 4:2:2
	SD-SDI	480i @60Hz, 4:2:2
	ITU-R BT.656	576i @50Hz, 4:2:2

Compatible Audio Format	3G-SDI	48kHz, 16 / 20 / 24 bit, 2 CH, Synchronized Video
	HD-SDI	48kHz, 16 / 20 / 24 bit, 2 CH, Synchronized Video
	SD-SDI	48kHz, 16 / 20 / 24 bit, 2 CH, Synchronized / Asynchronized Video

Max. Transmission Distance 75 ohm coaxial cable	3G-SDI	150m at 2.97Gb/s
	HD-SDI	250m at 1.485Gb/s
	SD-SDI	480m at 270Mb/s

< 4.3 > Options : MCS

MCS (Multi-display Control)



More control is always good. Especially when it is necessary and easy. Austin Hughes provides MCS solution to control the **OSD** of various UltraView LCD display up to 64 units.

The RS-232C is used for the communication between the PC and the first display via a 15 feet serial cable while the CAN bus is used for the various LCD displays cascade together via CAT 5/6 cable, and daisy chain up to 1,000 meters.

Designed for use with UltraView LCD displays, Austin Hughes provides a MCS input module without using additional space or power and it comes standard with a 2-year warranty.

MCS

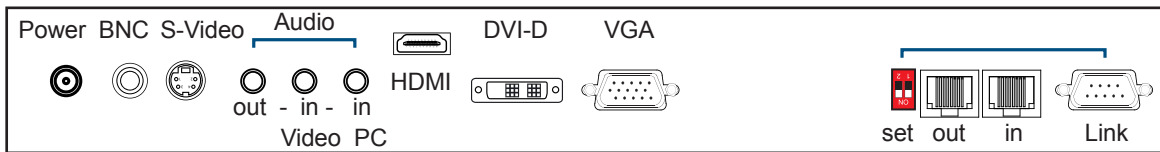

*** Please download the protocol of MCS control at :
<http://www.austin-hughes.com/support/usermanual/ultraview/UM-UV-MCS.pdf>

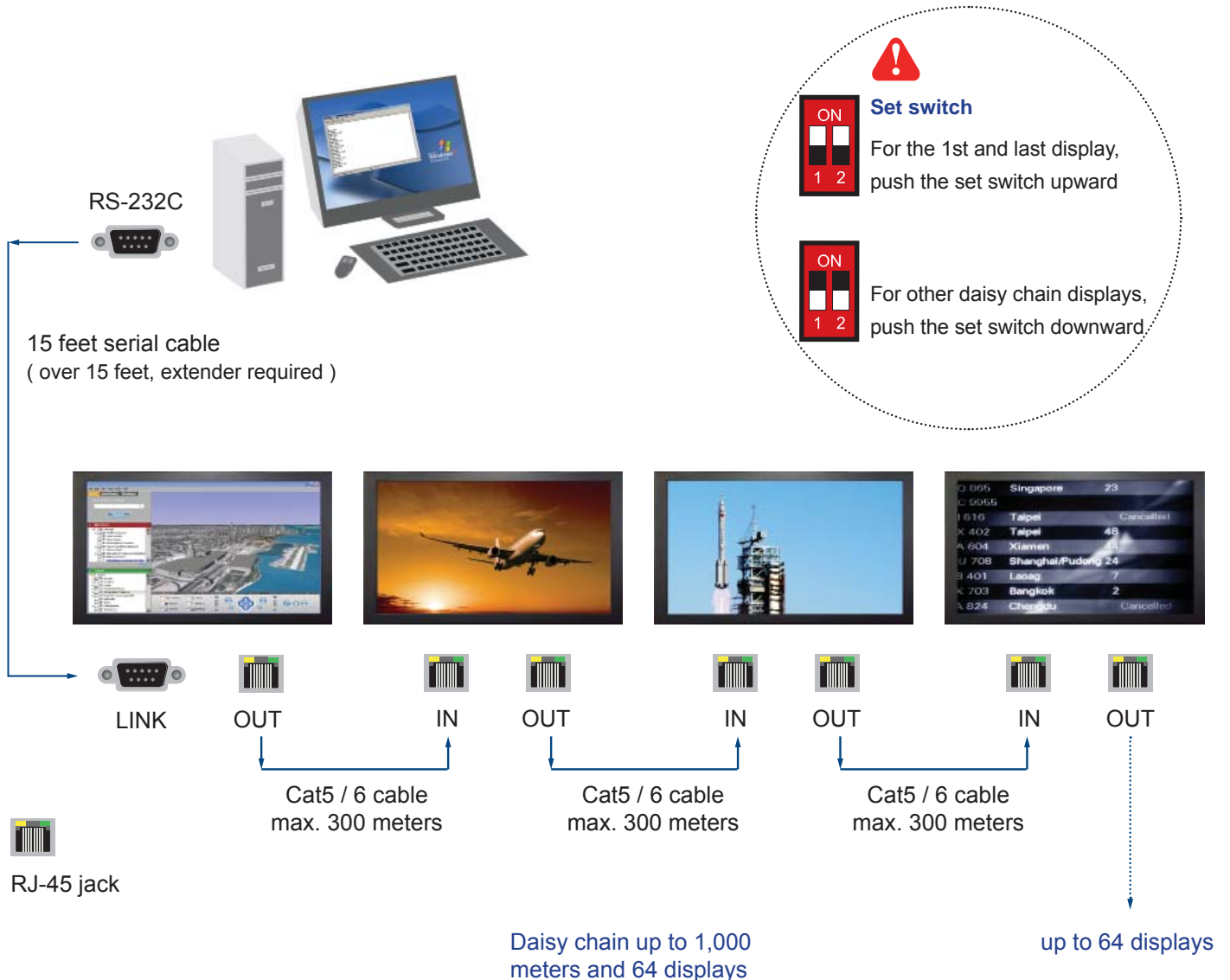

AV2.2D Upgrade Options

- **DVI-D** (DVI-D TMDS single link)
- **AV** (S-Video + Composite, BNC)
- **Audio** (3.5mm audio jacks for audio in & out, and 2W + 2W speakers)

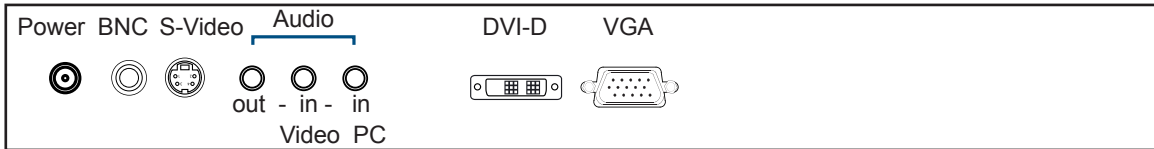

AV2.2H Upgrade Options

- **HDMI** (HDMI 1.1, CEA-861-D)
- **AV** (S-Video + Composite, BNC)
- **Audio** (3.5mm audio jacks for audio in & out, and 2W + 2W speakers)

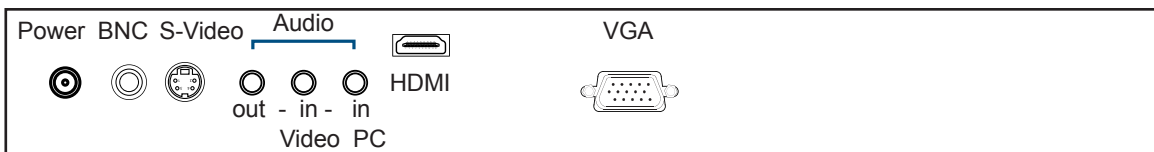

AV2.2 upgrade option comes with RC-1 remote controller x 1.

How to Use RC-1 Remote Controller

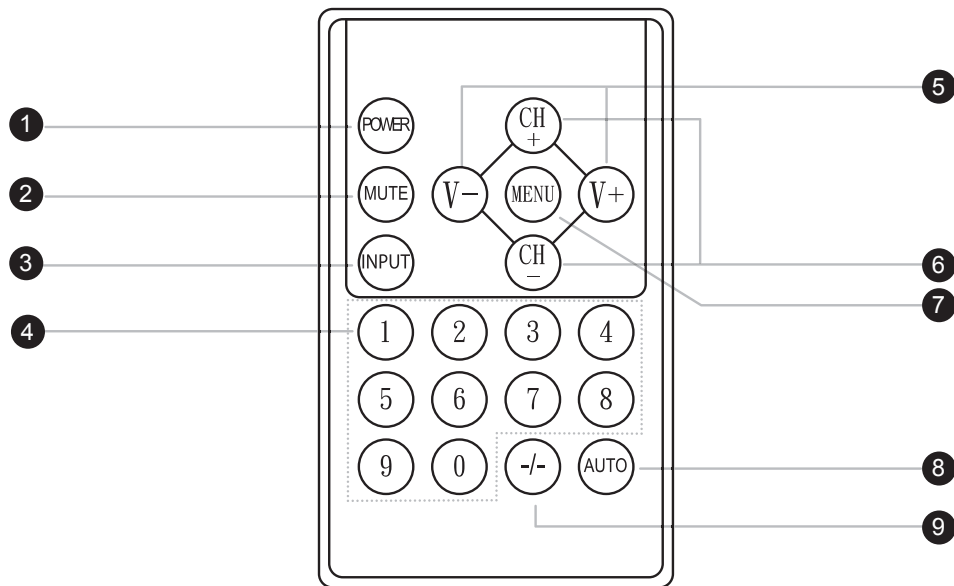

①	POWER	Switches on or off the TV
②	MUTE	Turn on or off the speaker
③	INPUT	Switch to signal input mode
④	0-9	Select channels. For channel numbers 10 and above, enter the second digit within two seconds.
⑤	V + / -	Increase or decrease the speaker volume
⑥	CH + / -	Increase or decrease the channel number
⑦	MENU	Display the menu on the screen or go to the previous menu
⑧	AUTO	For auto searching
⑨	- / -	For setting one or two input digit

< 4.5 > AV3.0 Upgrade Options :

20" LCD Display

- **HMDI** (HDMI 1.1, CEA-861-D)
- **DVI-D** (DVI-D TMDS single link)
- **AV** (S-Video + Composite, BNC)
- **Audio** (3.5mm audio jacks for audio in & out, and 2W + 2W speakers)

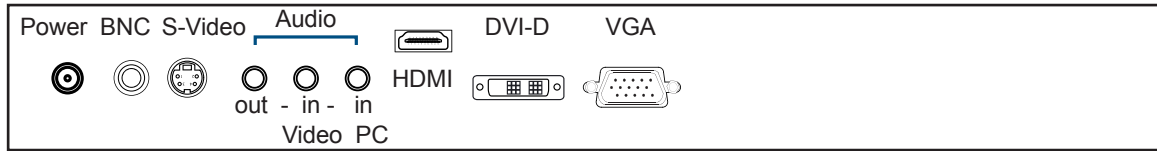

Casing dimensions will be changed.

< 4.6 > Options : Touchscreen & driver



20" USB Touchscreen Specification

Model	TRB e-Resistive
Technology	5-Wire Resistive
Touch Point	Single
Input Type	Finger or Stylus
Resolution	2048 x 2048
Touch Point Accuracy	-
Response Speed	15 ms
Activation Force	≤ 50 g
Surface Hardness	3H
Light Transmission	80% ± 3%
Haze	8% ± 3%
Durability	10 million touches
Top Layer	ITO Film
Bottom Layer	ITO Glass
Thickness	3.2 ± 0.2 mm
Connector	USB Type A
Compatibility	Windows 7 / XP / Vista, Linux

- USB touchscreen package includes 1 x 6ft USB cable, quick reference guideline and CD disc
- For detailed information, please refer to the attached CD disc
- As the touchscreen unit is not made of toughened glass, please handle it carefully

USB Touchscreen

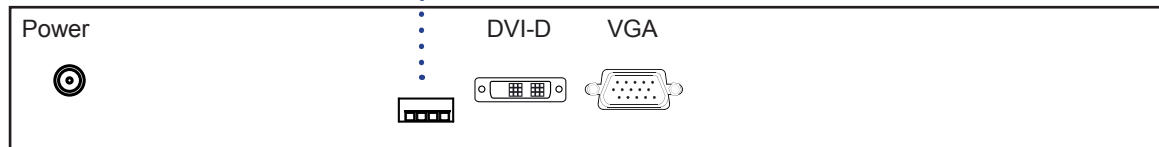



TRB Driver

Please follow the below steps to setup the touch screen:-

Step 1. Run the bundled CD disc or download the driver from the link below :
<http://www.austin-hughes.com/downloads/UVDL/driver.html>

Step 2. Double click the Setup.exe

Step 3. Follow the installation instruction to finish the setup

Step 4. After installation, run the TouchKit program & the “4 point calibration”



Please do the initial calibration after the first setup

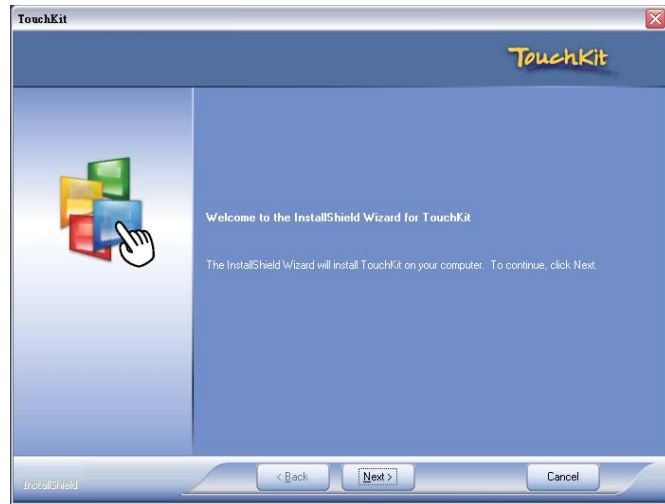

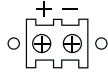

< 4.7 > Options : DC Power



Model	12V	24V	48V	110 ~ 125V
Input rating				
Input voltage:	12-Volt	24-Volt	48-Volt	110-Volt
Input range:	9 ~ 18V	18 ~ 36V	36 ~ 75V	66 ~ 160V
Input current				
- No load	50 mA	50 mA	50 mA	40 mA
- Full load	4950 mA	2450 mA	1220 mA	993 mA
Output rating				
Output voltage:	12-Volt	12-Volt	12-Volt	12-Volt
Output current:	4.16A	4.16A	4.16A	8.4A
Efficiency	84%	85%	85%	92%

	Input	Part no.		MIL Standard
MIL - type Connector	DC Power *** (Male)	MS3470W8-33P		MIL - DTL - 26482
	VGA *** (Male)	MS3470W14-15P		MIL - DTL - 26482

*** There are several additional MIL DC and VGA connector types with varying design characteristics to meet cost considerations and to provide users with the most design flexibility possible. For more information, please contact us.

	Input	Part no.		Standard
Lockable Connector	DC Power (Male)	YM-Ext-461CP001		D-type 3W3
	USB	LUSB - A111 - 00		-

*** MIL - type or Lockable connectors above can be integrated with our LCD displays. Sale service just for connectors not provided.

< 4.10 > Options : TV (Analog)

20" LCD Display

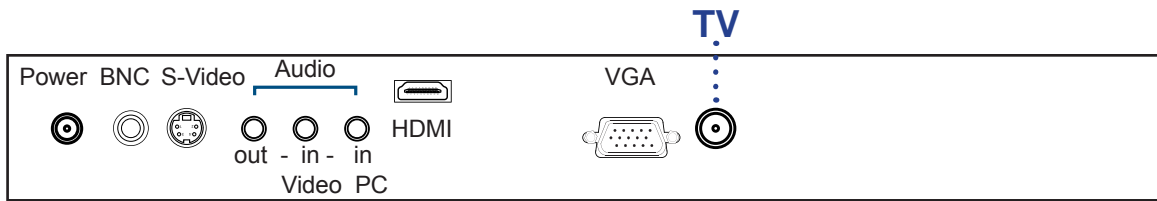

*** For TV option :

- (1) The AD board comes standard with HDMI, VGA, S-Video, BNC, audio inputs and RC-2 remote controller.
- (2) Casing dimensions will be changed.

How to Use RC-2 Remote Controller

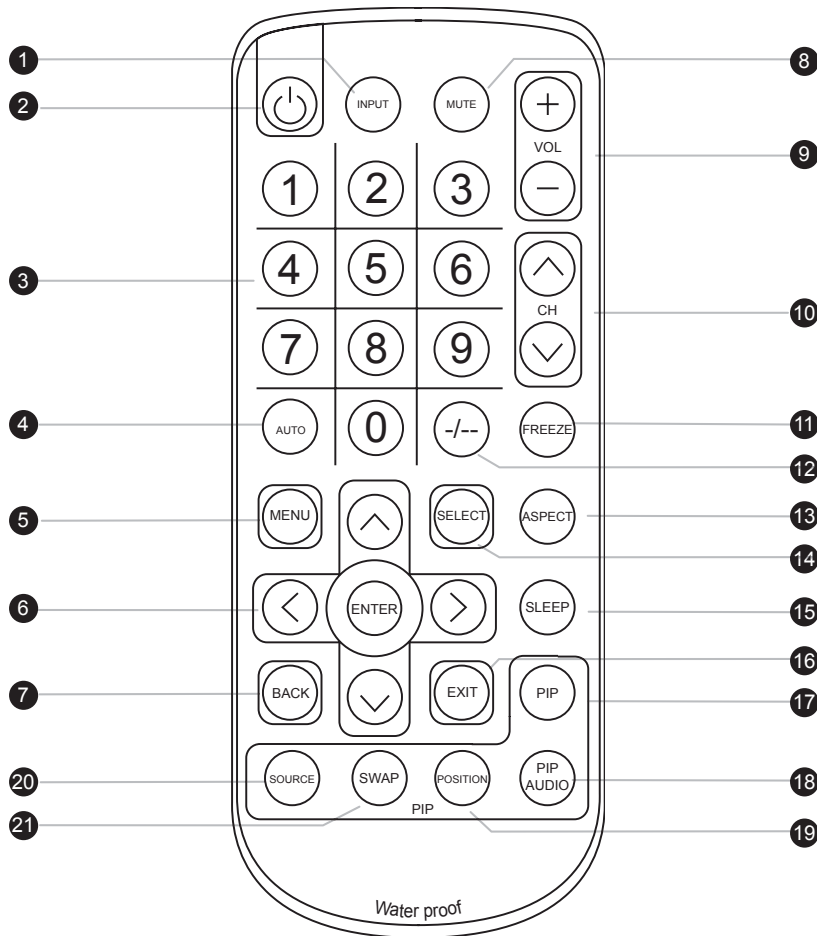

①	INPUT	Select the source
②		Switches on or off the TV
③	0 - 9	Only use in TV mode. Select channels. For channel numbers 10 and above, enter the second digit within two seconds.
④	AUTO	Auto adjust
⑤	MENU	Display the menu on the screen or go to the previous menu
⑥	▲ / ▼ / ◀ / ▶ / ENTER	Go to the upper menu or select the previous value / Go to the next menu or select the next value / Decrease the setting value / Increase the setting value or enter to the select item setting Enter to the select item settings or excude the setting
⑦	BACK	Back to previous value
⑧	MUTE	Turn on or off the speaker
⑨	Vol + / -	Increase or decrease the speaker volume
⑩	CH + / -	For TV model only, increase or decrease the channel number
⑪	FREEZE	Reserve for OEM model
⑫	- / --	For setting input single or double digits
⑬	ASPECT	Adjust the screen size
⑭	SELECT	To select the existing item
⑮	SLEEP	Select the sleeping time
⑯	EXIT	Exit the menu or cancel
PIP functions		
⑰	PIP	Picture in picture
⑱	PIP AUDIO	To set the audio of in PIP mode
⑲	POSITION	To set the screen position in PIP mode
⑳	SOURCE	PIP Source
㉑	SWAP	Swap screen in PIP mode

The company reserves the right to modify product specifications without prior notice and assumes no responsibility for any error which may appear in this publication.

All brand names, logo and registered trademarks are properties of their respective owners.

Copyright 2015 Austin Hughes Electronics Ltd. All rights reserved.