

# EUREKA

**EUREKA**<sup>®</sup>

**Built-In**<sup>™</sup>  
vacuum systems



## Accessory Kit Owner's Guide CV190 Series, CV200 Series

Features may  
vary by model

Household Type

Refer to rating plate on cleaner for  
model and serial number. Record the  
number and keep for future reference.

Model #

Serial #

**FOR LOCATION OF NEAREST EUREKA  
WARRANTY STATION OR SERVICE  
INFORMATION CALL 1-800-282-2886.**

### Index

Important Safeguards .....	2
Service Information .....	4
Assemble & Use .....	5
Easy Change Wand .....	6
Maintain .....	7
Brush Roll .....	8
Warranty .....	10-11
Order Form .....	Center of book

# IMPORTANT SAFEGUARDS

When using an electric appliance, basic precautions should always be followed, including the following:

**READ ALL INSTRUCTIONS BEFORE USING THIS VACUUM CLEANER**

## WARNING

To reduce the risk of fire, electric shock, or injury:

- Do not use outdoors or on wet surfaces.
- **Do not leave vacuum cleaner when plugged in.** Remove hose from inlet valve and unplug from outlet when not in use and before servicing.
- Do not allow to be used as a toy. Close attention is necessary when used by or near children.
- Use only as described in this manual. Use only manufacturer's recommended attachments.
- Some hoses contain electrical wires. Do not use if damaged, cut, or punctured. Avoid picking up sharp objects.
- Always turn off this appliance before connecting or disconnecting either hose or motorized nozzle.
- Do not use with damaged cord or plug. If vacuum cleaner is not working as it should, has been dropped, damaged, left outdoors, or dropped into water, return it to a service center before using.
- Do not pull or carry by cord, use cord as a handle, close a door on cord, or pull cord around sharp edges or corners. Do not run vacuum cleaner over cord. Keep cord away from heated surfaces.
- Do not use extension cords or outlets with inadequate current carrying capacity.
- Turn off all controls before unplugging.
- Do not unplug by pulling on cord. To unplug, grasp the plug, not the cord.
- Do not handle plug or vacuum cleaner with wet hands.
- Do not put any object into openings. Do not use with any opening blocked; keep free of dust, lint, hair, and anything that may reduce airflow.
- This vacuum cleaner creates suction and contains a revolving brush roll. Keep hair, loose clothing, fingers, and all parts of body away from openings and moving parts.
- Do not pick up anything that is burning or smoking, such as cigarettes, matches, or hot ashes.
- Do not use without dust bag or filter(s) in place.
- Belt pulleys can become hot during normal use. To prevent burns, avoid touching the belt pulley when servicing the drive belt.
- Use extra care when cleaning on stairs.
- Do not pick up flammable or combustible liquids such as gasoline, or use in areas where they may be present.
- Store your cleaner indoors in a cool, dry area.
- Keep your work area well lighted.
- Unplug electrical appliances before vacuuming them.

## SAVE THESE INSTRUCTIONS

# CONSEILS DE SÉCURITÉ

Lors de l'utilisation d'un appareil électrique, quelques précautions élémentaires doivent être observées, incluant les suivantes:

**LISEZ TOUTES LES INSTRUCTIONS AVANT D'UTILISER VOTRE ASPIRATEUR.**

## AVERTISSEMENT

Pour réduire le risque de feu, de choc électrique ou blessure:

- N'utilisez pas à l'extérieur ou sur une surface mouillée.
- **Ne quittez pas l'aspirateur lorsqu'il est branché.** Fermer le poste et débrancher la corde électrique lorsqu'il n'est pas en marche et/ou avant de le réparer.
- N'utilisez pas comme un jouet. Portez attention l'orsque vous l'utilisez pies où par un enfant.
- Utilisez seulement comme décrit dans ce livret. Utilisez seulement les accessoires recommandés par le fabricant.
- Quelque contient fils électrique. Ne pas utiliser si dommage, coupure, ou piqûre. Éviter ramasser des objet pointu.
- Toujours fermer l'appareil avant de joindre ou détacher le tuyau ou lance motoriser.
- N'utilisez pas avec une corde où prise endommagée. Si l'aspirateur ne fonctionne pas comme il le faut, s'y il a été échappé, endommagé, laissé à l'extérieur, où échappé dans l'eau, retourné l'aspirateur à un centre de réparation avant de s'en servir.
- Ne tirez pas et ne portez pas par la corde, utilisez la corde comme une poignée, fermez un porte sur la corde, où tirez la corde autour des coins aigu. Ne passez pas l'aspirateur sur la corde. Éloignez la corde des surfaces chaudes.
- N'utilisez pas la corde électrique où la prise de courant avec insuffisamment de capacité de courant.
- Fermez tout les contrôle avant de débrancher.
- Ne débranchez pas en tirant sur la corde. Pour débrancher saisir la prise, non la corde.
- Ne touchez pas la prise où l'aspirateur avec les mains mouillées.
- Ne mettez aucun objets dans les ouvertures. N'utilisez pas avec des ouvertures bouchés; gardez libre de poussière, tissu ouaté, cheveux et n'importe quoi qui peut réduire la courant atmosphérique.
- Cet aspirateur créé de la succion et contient un rouleau-brosse tournant. Tenir les parties mobiles et les ouvertures loin des cheveux, du linge, des doigts et de toute partie du corps.
- Ne ramassez rien qui brûle où fument, tel que cigarettes, allumettes, où des cendres chaudes.
- N'utilisez pas sans le sac de poussière et filtre(s) en place.
- Les poulies du courroie peuvent devenir chaudes pendant l'utilisation normale. Pour prévenir des brûlures, évitez de touché la poulie du courroie lorsque vous réparez la courroie.
- Utilisez des précautions lorsque vous nettoyé sur des escaliers.
- N'utilisez pas pour ramasser des liquides inflammable où combustible, tel que de l'essence, où utilisé dans les endroits où ses derniers peuvent être présent.
- Entrezposez votre aspirateur à l'intérieur dans un endroit propre et sec.
- Garder votre lieu de travail bun éclairé.
- Débrancher les appareils électrique avant de les balayer.

## CONSERVEZ CES INSTRUCTIONS

To reduce the risk of electric shock, the hose with electrical wires has a polarized plug (one blade is wider than the other). This plug will fit in a polarized outlet only one way. If the plug does not fit fully in the outlet, reverse the plug. If it still does not fit, contact a qualified electrician to install the proper outlet. Do not change the plug in any way.

**Afin de réduire le risque de choc électrique**, le tuyau avec fils électrique est muni d'une fiche polarisée (une des lames est plus large). Cette fiche ne peut insérée dans une prise polarisée que d'une seule façon. Si la fiche ne peut être insérée dans la prise, retourner la fiche. Si la fiche ne peut toujours pas être insérée dans la prise, faire installer une prise adéquate par un électricien qualifié. Ne pas modifier la fiche.

## GENERAL INFORMATION

The built-in vacuum system is designed for dry pick up of dirt and dust. Avoid picking up hard or sharp objects with the system to prevent hose and plastic pipe damage or clogs.

## Service Information

The instructions in this booklet serve as a guide to routine maintenance. If additional service is required, telephone toll free:

**USA: 1-800-282-2886**  
**Mexico: 5670-6169**  
**Canada: 1-800-282-2886**

for the nearest Eureka Authorized Built-In Vacuum System Warranty Station. If you prefer, you can write to The Eureka Company, Built-In Vacuum System Department, 807 North Main Street, Bloomington, IL 61701, USA. In Canada write to The Eureka Company, 866 Langs Drive, Cambridge, Ontario N2H 2N7. Refer to the Eureka Built-In Vacuum System Warranty for complete service information.



**DO NOT OIL the motor in the motorized nozzle or the brush roll at any time. The bearings are permanently lubricated and sealed.**

## Rating Plate

The model, type and serial numbers are indicated on the rating plate located on the underneath side of the cleaner. For prompt and complete service information, always refer to these numbers when inquiring about service.

MODEL	TYPE	SERIAL NO.
VOLTS	AMPS.	HERTZ
HOUSEHOLD TYPE	SERVICE INFORMATION: 1-800-282-2886	
<b>THE EUREKA COMPANY</b>		
BLOOMINGTON, ILLINOIS 61701		

Refer to rating plate (on backside of cleaner) when inquiring about service.

# HOW TO ASSEMBLE AND USE

**Power-Touch® Handle**  
**Remote ON/OFF Selector**  
**for bare floor or carpet**

- Carpet** - push down on front
- Off** - middle position (on some models)
- Bare floor** - push down on back



**NOTE:**

Remote controls on Power-Touch handle will only operate if the hose is inserted into the inlet valve and the cord is connected to an outlet (refer to 5).

**Vacuum Control**

Cleaning suction is reduced by pushing lever down to LOW position. Place lever at HIGH position to increase suction for carpet cleaning.

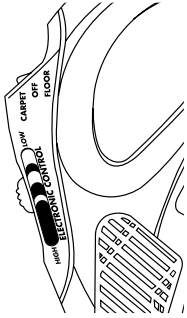

1. Snap wands together.
2. Put wands into socket.
3. Push motorized nozzle plug into retainer; secure cord in slot (see Detail A).
4. Place Power-Touch hose handle into wands until plug connects and button locks.
5. Open the inlet cover and hold the hose cuff so the power cord is opposite the cover.
  - a. Plug the hose into the inlet, or
  - b. Plug the hose into the inlet and connect the polarized plug to an outlet.
6. Step on motorized nozzle; pull back on handle.
7. Push on; select bare floor or carpet cleaning.

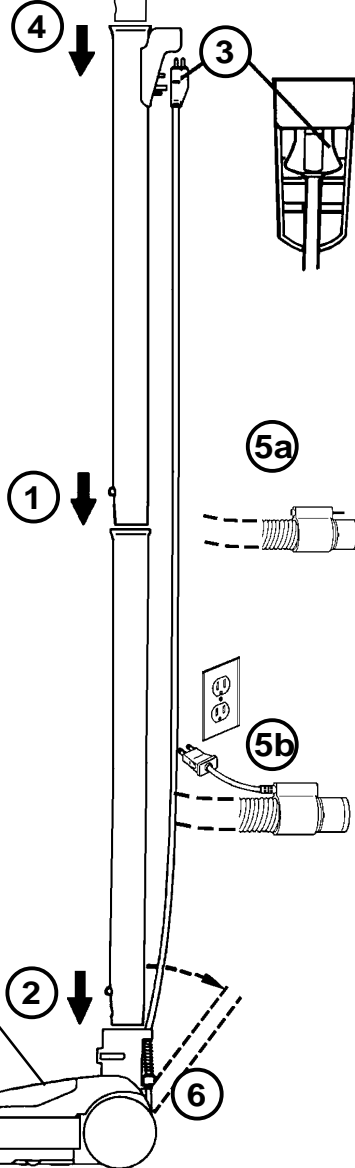

**Power View®**

Rotating brush roll could cause damage to bare floors. Be sure brush roll is stationary for bare floors; turning for carpet. Refer to Power-Touch handle; Remote Bare Floor/Carpet Selector.

**Headlight**

**NOTE:** Headlight turns on ONLY when brush roll is turning.

# Quick Release™ Wand System Instructions\*

\* Some Models

1. Snap interlocking wands together.
2. Slide Quick Release Lower Assembly into motorized nozzle handle socket.
3. Place electric cord from motorized nozzle into plug retainer along the back portion of the Quick Release Lower Assembly. (See Detail A)
4. Slide interlocking wands into Quick Release Lower Assembly.
5. Run electric cord along the rear of the interlocking wands and press into cord retainer.
6. Slide top plug of the electric cord into the plug retainer of the top interlocking wand. (See Detail B)
7. Place Power-Touch hose handle into wands until plug connects and button locks.

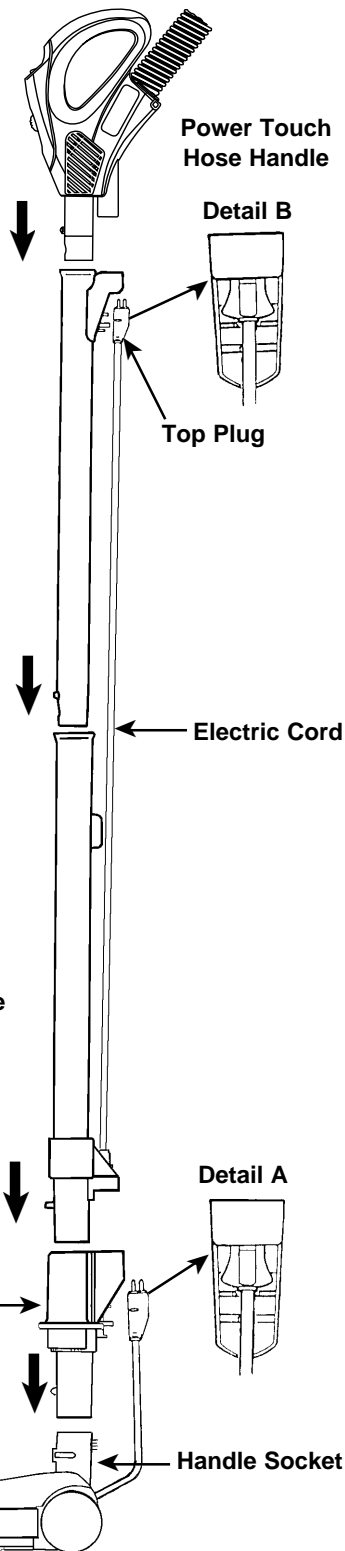

**DO NOT place cord in these clips for use with EASY CHANGE feature**



**Step here & pull up to release**

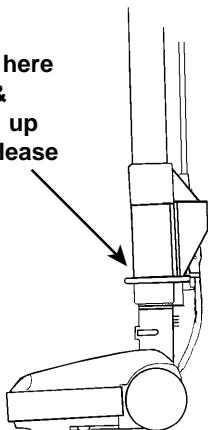

**Quick Release Lower Assembly**

**Detail A**

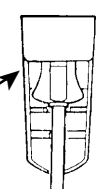

**Handle Socket**

## HOW TO MAINTAIN

The instructions given in this booklet serve as a guide to routine maintenance. To avoid unnecessary service calls check the belt and brush roll often. Replace the belt if it is stretched or cracked and clean the brush roll bristles when they are wrapped with thread and hair.

### Brush Roll Belt and Headlight

The brush roll belt on the motorized nozzle drives the brush roll to agitate, sweep, and comb the carpet nap. The belt should be checked regularly to be sure that it is in good condition. Replace the belt if it is stretching, cracking, or slipping. Cut away any hair or thread wound around the brush roll or belt pulleys because the buildup could cause the belt to rotate unevenly.

### How to Replace Worn Belt or Headlight Bulb

**NOTE: Disconnect power cord and wands from electrical hose before replacing belt or bulb. Belt pulleys can become hot during normal use. To prevent burns, avoid touching the belt pulley when servicing the drive belt.**

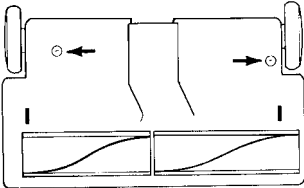

1. Remove two screws from bottom side. Turn over to grasp hood by handle socket and lift forward.

Replace headlight bulb, if necessary. Use **GENUINE EUREKA 25 watt replacement bulb 40009A**. Continue to step 2 to change belt. Skip to step 7 and 8 to replace hood on motorized nozzle.

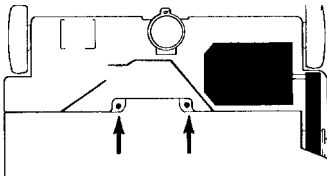

2. Remove two screws located in front of the light bulb and lift up to remove the brush roll cover.

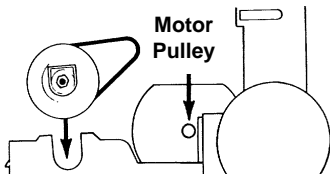

3. Lift out brush roll; replace new belt around brush roll pulley.

4. Return brush roll into base.

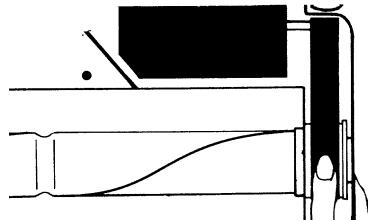
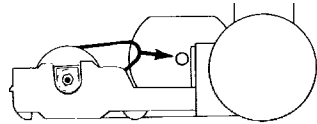

5. Rotate belt onto motor pulley.
6. Replace brush roll cover.

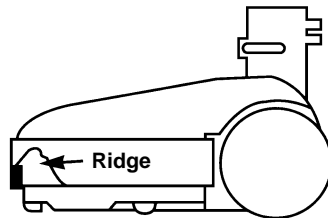

7. Tilt cover over ridge and push down.
8. Secure with screws on underside (refer to 1).

Look for the **GENUINE EUREKA PRODUCT** symbol.

Use **GENUINE EUREKA** replacement belt, 52201A.

## Brush Roll

The rotating brush roll sweeps and combs the carpet nap. Keep the brush roll free from hair and threads so it will continue brushing the carpet nap. When the bristles no longer touch a piece of cardboard held across the bottom plate, the brush roll should be serviced by an Authorized Warranty Service (refer to Service Information in the front of this booklet).

## Cleaner Care

**NOTE: Disconnect power cord from electrical outlet before cleaning unit.**

To keep the vacuum cleaner looking new, it can be wiped with a damp cloth and a mild soap solution, then thoroughly dried. Never use any type of chemical as chemicals can damage the cleaner.

## Storage

The cleaner should be stored in a clean, dry place with the Power-Touch handle removed from the wands.

## Carpet Cleaning Adjustment

The brush height is instantly and automatically adjusted to any carpet pile length. The floating head feature of your motorized nozzle allows the brush to float evenly and parallel to all carpet pile surfaces without manual adjustment.

## Edge Kleener®

Edge Kleener® feature provides for improved cleaning of carpets near walls and stationary furniture. Slots on the sides of the nozzle increase airflow to the edges of the cleaner and add to the cleaning efficiency of the cleaner. To operate, simply run cleaner along edge board. Edge Kleener® operates instantly and automatically.





# *The Eureka Built-In Vacuum Systems Limited Warranty*

## *What This Warranty Covers*

Your Eureka Built-In Vacuum System Power Unit is warranted to be free from all defects in material and workmanship in normal household use for a period of five years for all parts and two years for labor. Your Built-In Vacuum System Accessories are warranted for a period of one year. The warranty is granted only to the original purchaser and members of his or her immediate household. The warranty is subject to the following provisions.

## *What This Warranty Does Not Cover*

- Damages or malfunctions caused by negligence, abuse, or use not in accordance with the Owner's Guide.
- Defects or damages caused by unauthorized service or the use of other than Genuine Eureka parts.
- Installation materials or damage caused by faulty or improper installation of the Power Unit.
- Parts of the Accessories that require replacement under normal use, such as drive belts, light bulbs, and brush roll bristles.

## *What The Eureka Company Will Do*

The Eureka Company will, at its option, repair or replace a defective power unit, accessory, or part that is covered by this warranty. As a matter of warranty policy, the Eureka Company will not refund the consumer's purchase price.

## *Warranty Registration*

Please fill out and return the warranty registration card accompanying your cleaner.

## *Obtaining Warranty Service*

To obtain warranty service you must return the defective cleaner or cleaner part along with proof of purchase to any Eureka Authorized Built-In Vacuum System Warranty Station. You will find the nearest location in the Yellow Pages, under "Vacuum Cleaners--Built-In Vacuum Systems." Be certain that the Warranty Station is "Eureka Authorized Built-In Vacuum System Service and Repair."

For the location of the nearest Eureka Authorized Built-In Vacuum System Warranty Station or for service information, telephone toll free:

**USA: 1-800-282-2886**

**Mexico: 5670-6169**

**Canada: 1-800-282-2886**

If you prefer, you can write to The Eureka Company, Built-In Vacuum System Department, 807 North Main Street, Bloomington, Illinois 61701, USA. In Canada write to The Eureka Company, 866 Langs Drive, Cambridge, Ontario N3H 2N7.

If it is necessary to ship the cleaner outside your community to obtain warranty repair, you must pay the shipping charges to the Eureka Authorized Built-In Vacuum System Warranty Station. Return shipping charges will be paid by the Warranty Station. When returning parts for repair, please include the model, type, and serial numbers from the data plate on the cleaner.

## *Further Limitations and Exclusions*

Any warranty that may be implied in connection with your purchase or use of the cleaner, including any warranty of Merchantability or any warranty for Fitness For A Particular Purpose is limited to the duration of this warranty. Some states do not allow limitations on how long an implied warranty lasts, so the above limitations may not apply to you.

Your relief for the breach of this warranty is limited to the relief expressly provided above. In no event shall Eureka be liable for any consequential or incidental damages you may incur in connection with your purchase or use of the cleaner. Some states do not allow the exclusion or limitation of incidental or consequential damages, so the above limitation or exclusion may not apply to you.

This warranty gives you specific legal rights. You may also have other rights which vary by state.



## *Questions & Answers about Genuine Eureka Products*

**Q:** Why should I use only Genuine Eureka paper bags, belts, and parts in my Eureka vacuum cleaner?

**A:** Using Genuine Eureka Products, which are made to our exacting specifications and engineered with emphasis on quality, performance, and customer satisfaction, ensures the long life and cleaning efficiency of your vacuum cleaner. Overall, this saves you money and helps to keep your home clean.

**Q:** How can I be sure I am using only Genuine Eureka products in my vacuum cleaner?

**A:** Typically, packaged products and paper bags can be identified by a "Genuine Eureka Product" symbol (see illustration above). For further identification assistance, you may call our toll-free number, 1-800-282-2886, for the location of a nearby Eureka Authorized Warranty Station.

**Q:** Are there any differences between "made to fit" or "imitation" and Genuine Eureka paper bags, belts, and parts?

**A:** Yes, there are some very important differences in materials, quality, and reliability. Many customers have mistakenly purchased "imitation" paper bags and parts while thinking they purchased genuine. Unfortunately, many of these customers discovered the differences after they experienced related difficulties.

**For Genuine Eureka Value, Accept No Limitations!  
THE EUREKA COMPANY**

Bloomington, Illinois 61701

**For location of nearest  
Eureka Warranty Station  
or Service Information  
call 1-800-282-2886.**

Part No. 58437D (10/01)

©1999 White Consolidated Industries, Inc.  
Printed in U.S.A.