



Universal oven
UNP 200-800
UFP 400-800











Steriliser
SFP 400-800



Incubator
INP 200-800

Operating Instructions



1	Contents	2
2	General notes and safety notes	4
	2.1 Intended purpose when used as medical product	4
	2.2 Transport	4
3	Installation facilities (accessories).....	5
	3.1 Subframe (accessory).....	5
	3.2 Wall bracket (accessory)	5
	3.3 Stackable version (accessory)	5
	3.4 Initial start-up	6
	3.5 Oven load	6
4	Technical data.....	7
	4.1 Standard equipment of PERFECT ovens.....	8
	4.2 Material quality	8
	4.3 Electrical equipment.....	9
	4.4 External connection.....	9
5	Oven construction and operation.....	10
	5.1 Operating the door	10
	5.2 Controls and indications.....	11
	5.3 Switching on.....	11
	5.4 Setting the temperature	11
6	Selecting the operating mode	12
7	Setting the parameters	12
	Interior lighting (option)	12
8	Normal operation 	13
	Setting example "Normal operation"	14
9	Weekly programmer 	15
	Programming example "Weekly programmer"	16
10	Programme operation 	17
	10.1 Closure commands for ramp segments.....	19
	Programming example programme operation	20
11	Printer 	23
12	Basic oven settings 	24
	12.1 Real-time clock.....	25
13	Temperature monitor and protection devices.....	26
	13.1 Mechanical temperature monitor: temperature limiter (TB)	26
	13.2 Electronic temperature monitor	27
	13.2.1 Overtemperature protection 	27
	13.2.2 Undertemperature protection 	27
	13.2.3 Adjustable temperature monitor (TWW) Protection Class 3.1 to DIN 12 880.....	28
	13.2.4 Adjustable temperature limiter (TWB) Protection Class 2 to DIN 12 880.....	28
	13.2.5 Automatic temperature monitor (ASF) 	29
14	Calibration.....	32

15	Communication interface for the PC.....	34
	15.1 Communication interface RS232C	34
	15.2 Bus interface RS485	35
16	Heating power distribution BALANCE.....	36
17	Report memory.....	37
	17.1 Reading the report memory.....	37
	17.2 Reading the report memory into the PC via RS232C.....	37
	17.3 Printing the report memory from the oven.....	37
18	Memory card: MEMoryCard XL	38
	18.1 Programming the MEMoryCard XL from the oven.....	38
	18.2 Programming the MEMoryCard XL from a PC with the oven	38
	18.3 Programming the MEMoryCard XL from a PC using the read-write unit.....	38
	18.4 Documentation on memory card MEMoryCard XL.....	39
19	Sterilisation chip card (for INP incubators only).....	40
20	User-ID-Card (available as optional extra)	41
21	Sterilisers	42
	21.1 Purpose definition for MEMMERT hot air sterilisers	42
	21.2 Notes in accordance with Medical Products Guidelines	42
	21.3 Guidelines for sterilisation in MEMMERT hot air sterilisers	42
	21.4 Steriliser cassettes.....	47
22	Cleaning.....	48
23	Maintenance	48
24	Error messages	49
25	Supply failure	49
26	CE Conformity Declaration	50
27	Address and customer service	53
28	Index.....	54

2 General notes and safety notes

You have purchased a technically fully proven product which has been produced in Germany with the use of high-grade materials and the application of the latest manufacturing techniques; it has been factory tested for many hours.

In addition we guarantee the supply of spare parts over 10 years.



This mark in the Operating Instructions means:
Watch out
Important Note



This mark on the product means:
Note Operating Instructions
Warning – oven hot when operating



Observation of the Operating Instructions is necessary for faultless operation and for any possible claims under warranty. If these Instructions are disregarded, all claims under warranty, guarantee and indemnification are excluded.

The right to technical modifications is reserved.
Dimensional details are not binding.

2.1 Intended purpose when used as medical product

For ovens covered by the scope of the Directive 93/42/EWG (Directive of the Commission on the harmonization of the legal regulations of the Member States on medical devices) the following intended purpose applies:

- For ovens series UFP:
The product is intended for heating non-sterile cloths, sheets and blankets.
- For ovens series INP:
The product is intended for the heat treatment of wash and infusion solutions.
- For ovens series SFP:
The product is intended for the sterilisation of medical products with dry heat using hot air at atmospheric pressure.

2.2 Transport

Always use gloves!

If the oven has to be carried, at least 2 persons are required to transport it.



Do not place the oven on a readily inflammable support surface!
It is important that the oven is set up accurately horizontally!

3 Installation facilities (accessories)

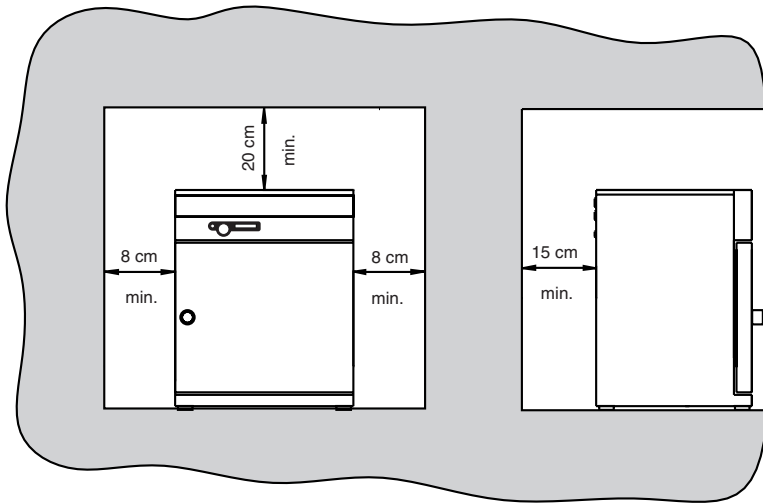

The oven can be placed on the floor or on a bench (working surface). It is important that the oven is set up accurately horizontally; the door may have to be adjusted (see Section „Maintenance“)

The spacing from the back of the oven to the wall should be at least 15 cm. The spacing to the ceiling must not be less than 20 cm and that at the side to the wall not less than 8 cm. Generally it is essential to have adequate air ventilation around the oven.

Model 800 is mounted on castors. The front castors pivot and can be locked. In order to ensure the stability of the oven the front castors must always be set facing towards the front.

Information on accessories will be found in our leaflet or on our internet page www.memmert.com. Please note the installation instructions for our accessories.

3.1 Subframe (accessory)

Oven models 500 to 700 can be mounted on a subframe

3.2 Wall bracket (accessory)

Oven models 200 to 700 can be wall-mounted using the wall bracket. The wall bracket is factory-fitted with a fire-resistant plate. The size and length of the screws used and of the corresponding dowel plugs depend on the total weight (oven plus load) and vary with the condition of the wall.

3.3 Stackable version (accessory)

Two ovens of the same model size can be stacked on each other. Note that the oven with the lower working temperature must always be placed at the bottom.

Foot locators have to be fitted on the bottom oven. (Model 700 can only be stacked using an intermediate frame.)

- Take off cover of bottom oven
- Place drill jig (supplied with foot locators) into the inverted cover at the back
- Mark holes and drill 4.2 mm dia.
- Screw the foot locators to the top of the cover using the screws and nuts supplied
- Re-fit the cover

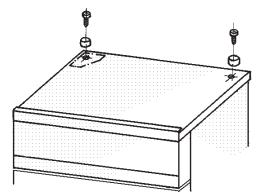
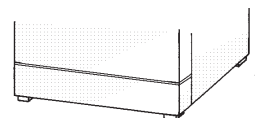
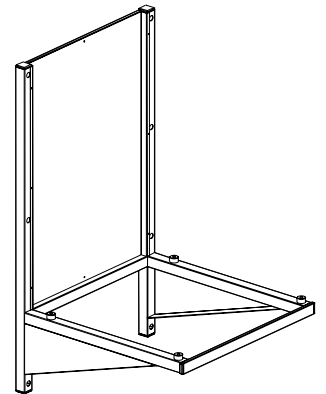
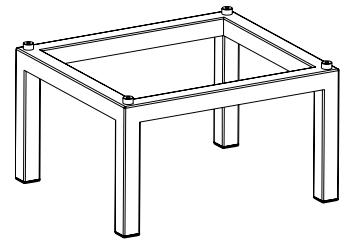

3.4 Initial start-up

When the oven is started up for the first time, it should be supervised continuously until steady conditions have been reached. Severe vibrations during transport may cause movement of the temperature probes in their holder inside the chamber. Note therefore that before the first start-up the temperature probes should be checked for their correct position and, if necessary, carefully aligned in their mounting (see ill).

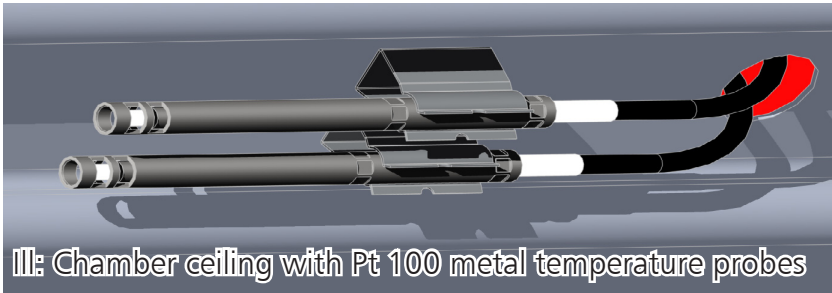

III: Chamber ceiling with Pt 100 metal temperature probes

3.5 Oven load

Full consideration must be given to the physical and chemical properties of your load (e.g. combustion temperature etc.) in order to prevent serious damage to load, oven and surroundings.

Please note that the MEMMERT ovens described here are not explosionproof (they do not conform to the Industrial Association Specification VBG 24) and are therefore not suitable for drying, evaporating and burning-in of paints, enamels or similar materials whose solvents may produce an inflammable mixture with air. There must be no possibility of the formation of inflammable gas/air mixtures either within the oven chamber or in the immediate surroundings of the equipment.

Large amounts of dust or corrosive fumes inside the oven chamber or in the surroundings of the equipment may produce deposits within the oven and lead to short-circuits or damage the electronics. It is therefore important that adequate precautions are taken against excessive dust or corrosive fumes.

In order to ensure proper air circulation inside the chamber, there must be sufficient spacing of the load inside the oven. Do not place any load on the floor, against the side walls or underneath the ceiling of the chamber (heating ribs). In order to ensure optimum air circulation the shelves must be so inserted that the air spacings between door, shelf and rear chamber wall are approximately equal.

The maximum number and the loading of the shelves can be found in the table in the [Section "Technical Data"](#). With unfavourable loading (too closely spaced) and completely opened ventilation it is possible that the set temperature may be reached only after a longer period of time.

See stick-on label "Correct Loading" on the oven!

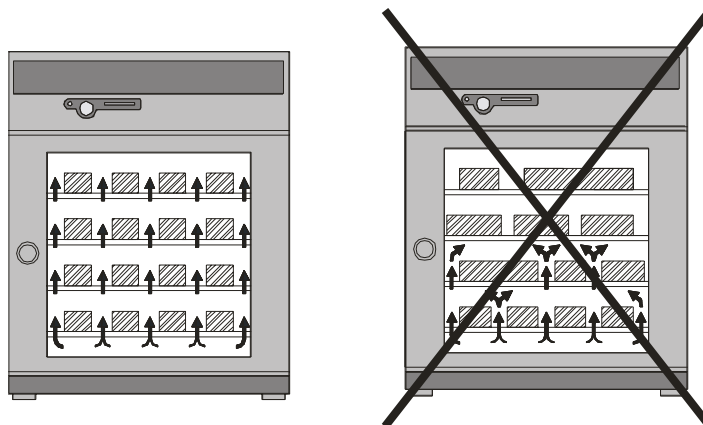

4 Technical data

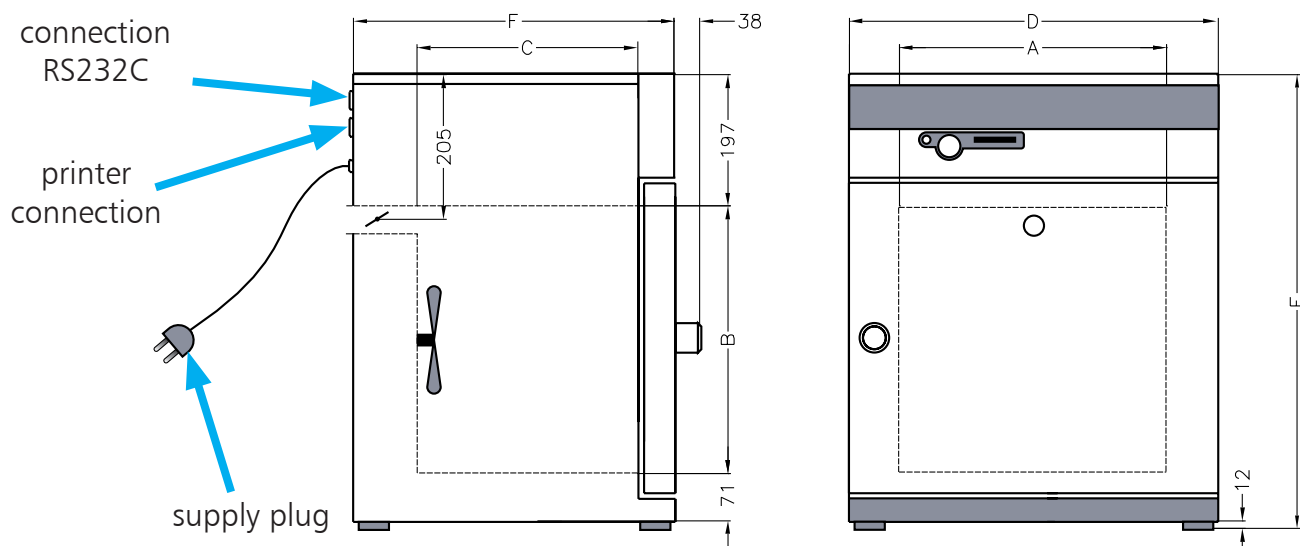

Model	200	300	400	500	600	700	800
Chamber width A [mm]	400	480	400	560	800	1040	1040
Chamber height B [mm]	320	320	400	480	640	800	1200
Chamber depth C [mm]	250	250	330	400	500	500	600
Oven width D [mm]	550	630	550	710	950	1190	1190
Oven height E [mm]	600	600	680	760	920	1080	1605
Oven depth F [mm]	400	400	480	550	650	650	750
Chamber volume [litre]	32	39	53	108	256	416	749
Weight [kg]	28	30	35	50	87	121	170
Power, ovens UNP/UFP/SFP [W]	1100	1200	1400	2000	2400	4000	4800
Power, ovens INP [W]	440	500	800	900	1600	1800	2000
Max. number of shelves	3	3	4	5	7	9	14
Max. load per shelf [kg]	30	30	30	30	30	30	30
Max. load per oven [kg]	30	30	90	60	80	100	160
Ambient conditions	Ambient temperature 5°C to 40°C rH 80% max., no condensation Overvoltage category: II Contamination level: 2						
Setpoint temperature range	20°C to nominal temperature (details see label)						
Setting accuracy:	up to 100°C: 0.1°C from 100°C: 0.5°C						
Working temperature range	From 5°C above ambient temperature up to nominal temperature = maximum temperature (details see label) With fan switched on (UFP/SFP) from 10°C above ambient temperature up to nominal temperature = maximum temperature (details see label)						

4.1 Standard equipment of PERFECT ovens

- Electronic fuzzy-supported PID process controller with permanent power matching and time-saving auto-diagnostic system for rapid fault finding (see Section „Error messages“)
- Language selection
- Alphanumerical text display
- Internal report memory 1024kB for storing actual temperature, setpoint temperature, fan, air valve and error states with time stamp
- Control of oven and documentation of actual values on MEMoryCard XL
- Programme sequence control for up to 40 ramp segments
- Fan with speed adjustment on recirculation ovens (adjustment in 10% steps)
- Air valve with servo adjustment (adjustment in 10% steps) for recirculation or fresh air operation
- Integral weekly programmer with group function (e.g. all workdays)
- Recessing push/turn control for simple operation of oven
- Visual alarm indication
- Built-in sounder as alarm on overlimit, as audible signal at programme end, and to acknowledge input (key click)
- Digital monitor controller for overtemperature, undertemperature, and as automatically setpoint-following monitor (ASF)
- Mechanical temperature limiter (TB Class 1)
- Monitor relay to switch off heating in case of fault
- Two separate PT100 temperature sensors Class A in 4-wire circuit for control and monitoring
- Convenient integral 3-point temperature calibration
- Temperature-dependent ventilation of control panel and door
- Parallel printer interface (PCL3 compatible)
- Serial RS-232C interface for computer-supported temperature programmes and for reading the internal report memory
- MEMMERT software “Celsius 2007” for remote operation of oven via a PC and for reading the report memory inside the controller
- A pre-formatted blank MEMoryCard XL with 32 kB storage capacity, reprogrammable for up to 40 ramp segments and additionally 270 hours report memory at 1 minute intervals
- Special equipment (to be ordered separately as accessories): subframe, wall bracket, wire shelf, sterilisation cassette, cable RS232C to DIN 12 900-1, external card reader for MEMoryCard XL for connection to the PC RS232C interface, 25-way printer cable (parallel, screened)

4.2 Material quality

For external housing MEMMERT employs stainless steel (Mat.Ref. 1.4016). The chamber is made from stainless steel (Mat.Ref. 1.4301) which exhibits high stability, optimum hygienic properties and corrosion resistance against many (not all) chemicals (warning against e.g. chlorine compounds).

The oven load has to be checked carefully for its chemical compatibility with the above materials.

A compatibility table covering all these materials can be requested from MEMMERT.



WARNING! Always pull out the supply plug before opening the oven cover!

4.3 Electrical equipment

- Operating voltage see label 50/60 Hz
- Current rating see label
- Protection Class 1, i.e. operating isolation with ground connection to EN 61 010
- Protection IP20 to DIN EN 60 529
- Interference suppression to EN55011 Class B
- Oven protected by a fuse 250V/15A fast blow
- Controller protected by a 100 mA fuse (200 mA on 115 V)
- When connecting a MEMMERT oven to the electrical supply you have to observe any local regulations which apply (e.g. in Germany DIN VDE 0100 with FI protection circuit)

This product is intended to operate on a supply network with a system impedance Z_{max} at the transfer point (building connection) of 0.292 Ohm max. The user has to ensure that the product is only operated on an electrical supply network which meets these requirements. If necessary, details of the system impedance can be obtained from the local electricity supply authority.

Note:

Any work involving opening up the oven must only be carried out by a suitably qualified electrician!

4.4 External connection

Equipment connected to the external connections must have interfaces which meet the requirements for safe low voltage (e.g. PC, printer).

5 Oven construction and operation

Ovens Series UNP and INP have natural ventilation.

In Series UFP and SFP ovens, air circulation is provided by a fan on the back wall of the chamber.

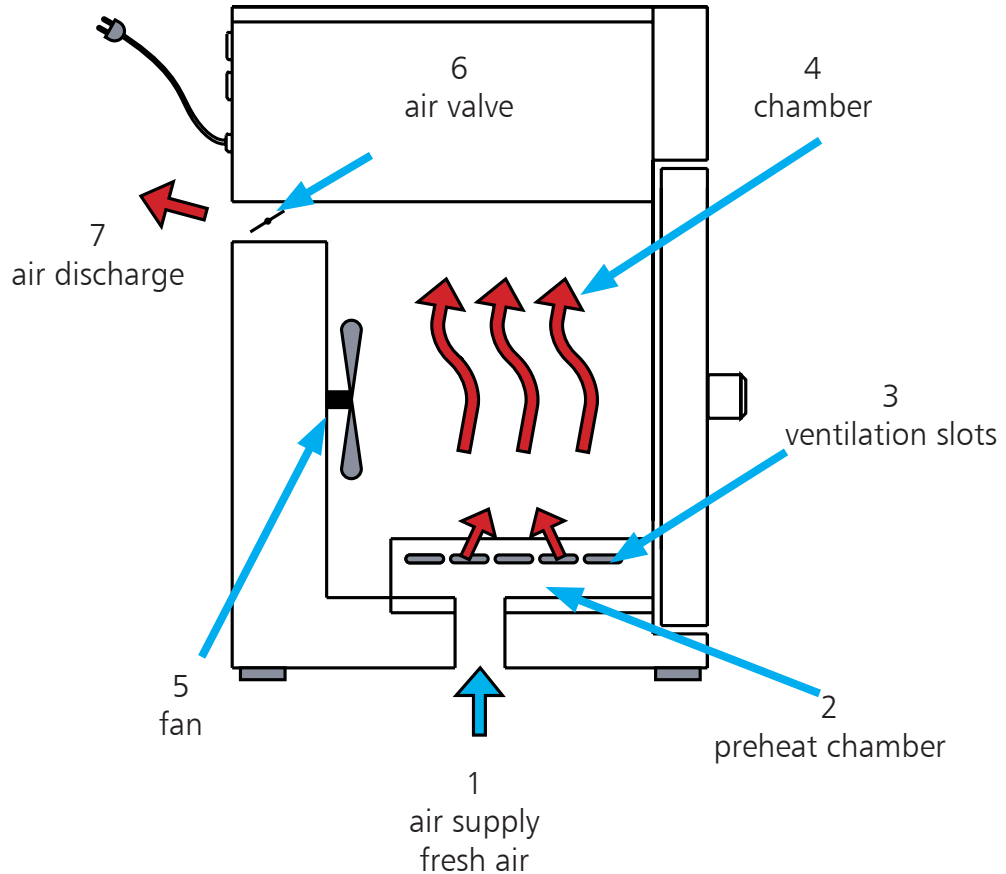

The incoming air (1) is warmed in a preheat chamber (2) in both convection and fan-circulation ovens. The preheated air enters the chamber (4) through ventilation slots (3) in the chamber side wall. The fan (5) on the chamber back wall produces a larger air throughput and a more intensive horizontal forced circulation compared with natural convection. The air valve (6) on the back of the oven controls the rate of air intake and discharge (air change) (7).

5.1 Operating the door

The door is opened by pulling on the door handle.

The door is closed by the door handle being pushed in.

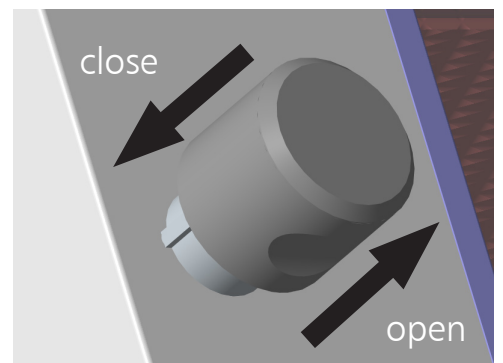

5.2 Controls and indications

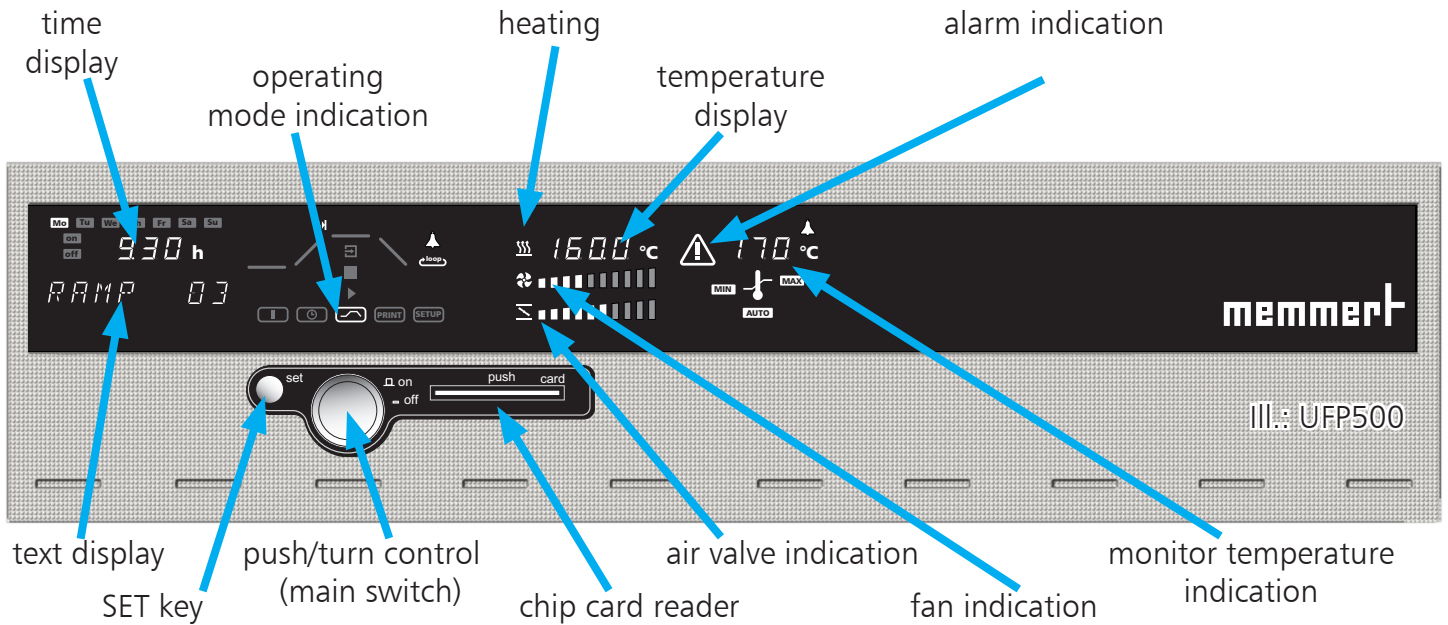

5.3 Switching on

The oven is switched on by pressing the push/turn control.

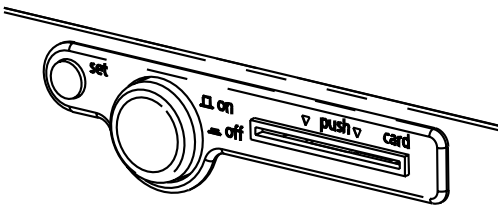

Oven switched off. The push/turn control is pushed in and protected against damage.

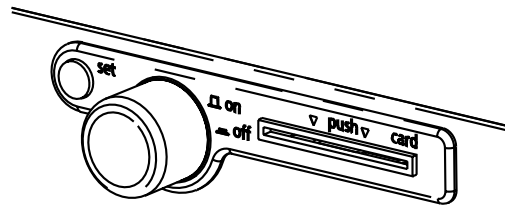

Oven switched on and can be operated using the push/turn control and the SET key.

5.4 Setting the temperature

Hold down the SET key and set the temperature setpoint with the push/turn control.

After the SET key has been released the display briefly flashes the temperature setpoint. The display then changes to the actual current temperature and the controller starts to control to the selected temperature setpoint.

6 Selecting the operating mode

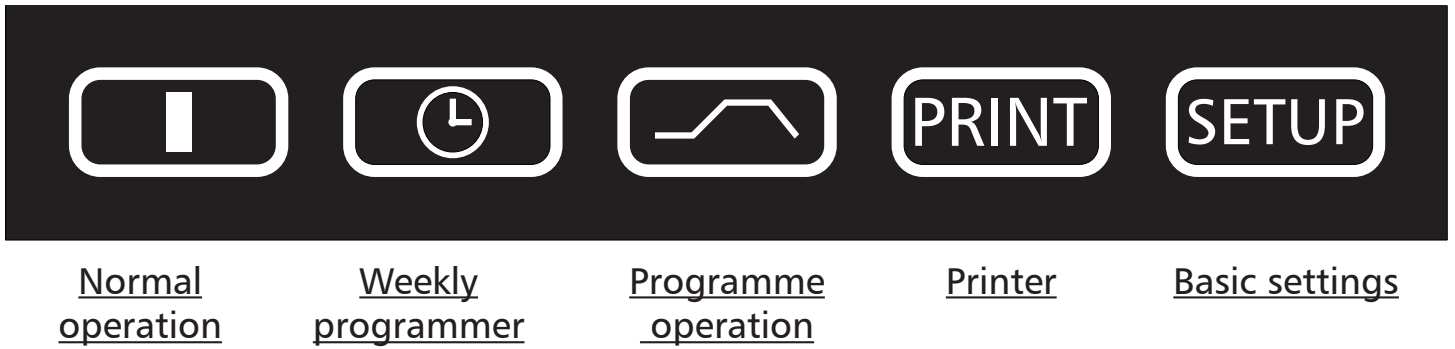

After holding down the SET key (approx. 3 sec), the current operating mode flashes on the display. A different operating mode can be selected with the push/turn control while the SET key is being held down. After the SET key has been released the controller operates in the new operating mode.

7 Setting the parameters

After an operating mode has been selected, all relevant controller settings are shown simultaneously on the display.

A parameter (menu item) can be selected by rotating the push/turn control; all other parameters are then dimmed.

The selected parameter flashes brightly and can now be altered with the push/turn control while holding down the SET key.

After the SET key has been released the newly set value is stored.

If the push/turn control or the SET key have not been operated for a period of 30 seconds, the controller automatically returns to the main menu.

Interior lighting (option)

Turn the push/turn control anticlockwise until the light symbol  is flashing.
While holding down the SET key, use the push/turn control to set the light ON or OFF.

When operating in the “weekly programmer” mode the internal illumination is switched off automatically when the equipment is switched off by the weekly programmer.

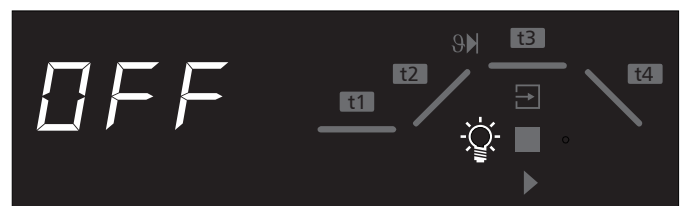
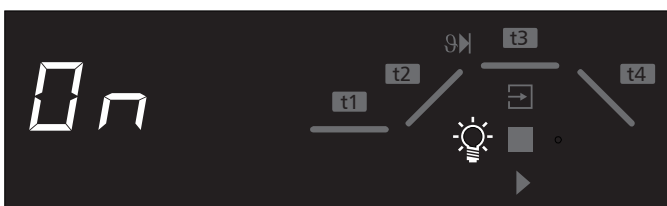

8 Normal operation



In this operating mode the oven operates continuously. The settings for operating the oven can be selected. The settings act directly on the operation of the oven.

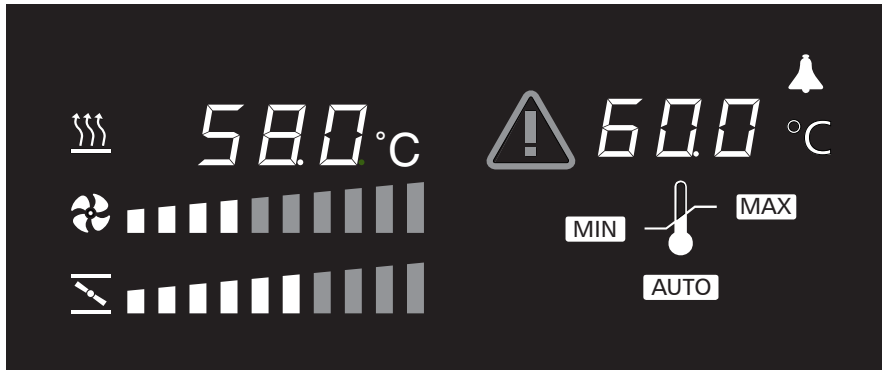

By rotating the push/turn control the following parameters can be selected and can be altered as described in the [Section „Setting the parameters“](#):

<p><u>Temperature setpoint</u> Range: 20 °C up to nominal temperature (details see label)</p>		
<p><u>Fan speed</u> Range: 0 to 100% in 10% steps.</p>		
<p><u>Air valve</u> Range: 0 to 100% in 10% steps.</p>		
<p><u>Temperature monitor</u> Adjustment range: MIN MAX AUTO (see Section “Temperature monitor”)</p>		

Setting example “Normal operation”

The oven (UFP500) has to heat up to 180°C at 50% fan speed and with the air valve 20% open. The monitor function has to operate at 200°C.

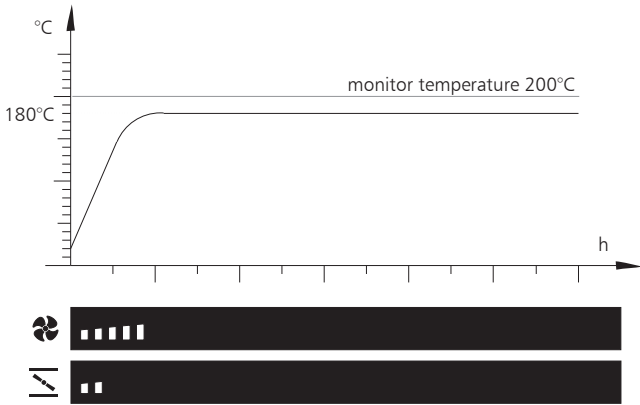

<p>1. Select operating mode “Normal operation”</p> <p>After holding down the SET key (approx. 3 sec), the current operating mode is flashing. Select operating mode I with the push/turn control while holding down the SET key. After the SET key has been released the controller is in operating mode I.</p>	
<p>2. Select temperature setpoint</p> <p>Hold down the SET key and use the push/turn control to select the required temperature setpoint of 180 °C. After the SET key has been released the oven briefly flashes the temperature setpoint. The display then changes to the actual temperature and the controller starts to control to the selected temperature setpoint 180 °C. Heating is indicated by the orange heater symbol. </p>	
<p>3. Select fan speed</p> <p>Turn the push/turn control clockwise until the fan symbol is flashing. While holding down the SET key, use the push/turn control to set 50% fan speed.</p>	<p>FAN</p>
<p>4. Set air valve for air vent</p> <p>Turn the push/turn control clockwise until the air valve symbol is flashing. While holding down the SET key, use the push/turn control to set the air valve to 20%.</p>	<p>FLAP</p>
<p>5. Select monitor temperature</p> <p>Turn the push/turn control clockwise until the overtemperature display MAX is flashing. Hold down the SET key and use the push/turn control to set the monitor temperature to 200 °C.</p>	

9 Weekly programmer



In this operating mode the weekly programmer is activated and the oven switches on and off automatically at the programmed times.

While the weekly programmer is in the OFF phase the oven is in standby mode. Heating and fan are switched off, the controller display is dimmed and shows the clock time.

The sequence of the weekly programmer is repeated every week.

A maximum of 9 time blocks, each consisting of ON time and OFF time, can be programmed.

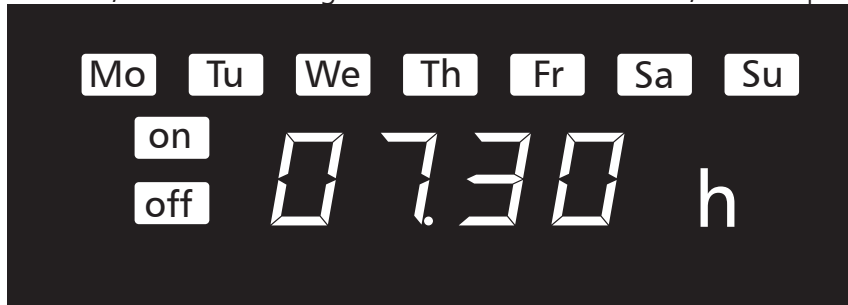

By rotating the push/turn control the following parameters can be selected and can be altered as described in the [Section "Setting the parameters"](#):

<u>Weekday</u> Range: Monday to Sunday	
<u>Day groups</u> Range: workday Mo-Fr weekend Sa-Su	
<u>No ON time: ----</u> On these days the oven is not switched on	
<u>ON time</u> Range: 00:00 to 23:59 hrs.	
<u>OFF time</u> Range: one minute above ON time to 24:00	

Further clockwise rotation selects the parameters (temperature setpoint etc.) as in operating mode I.

If no further settings (temperature setpoint etc.) are made for the ON phase, the controller accepts the values from operating mode I.

For safety reasons, always check that an ON time has been programmed only during the required time blocks and days.

Direct setting of the temperature setpoint:

When the controller is in stand-by mode or if the weekly programmer is in the ON phase, the temperature setpoint can be selected directly by briefly pressing the SET key. Clockwise rotation then selects fan speed, air flap and temperature monitor. Anticlockwise rotation again selects setting the individual time blocks.

Programming example “Weekly programmer”

The oven (UFP500) has to switch on at 07.30 hrs from Mo to Fr (workday group) and switch off at 18.00 hrs. In addition it has to operate on Saturday from 10.00 to 14.00 hrs.

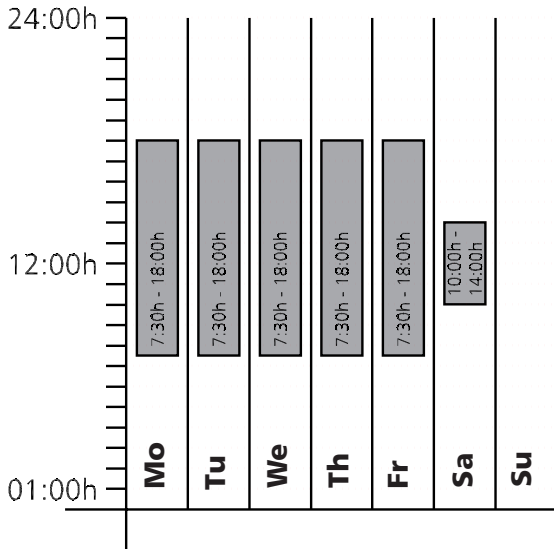

<p>1. Select operating mode “Weekly programmer” After holding down the SET key (approx. 3 sec) the current operating mode is flashing. Select operating mode “Weekly programmer” with the push/turn control while holding down the SET key. After the SET key has been released the controller is in operating mode “Weekly programmer”.</p>	
<p>2. Switch on at 07.30 hrs Mo-Fr Turn the push/turn control anticlockwise to select the symbols “Mo-Fr on” (workday group). Hold down the SET key and use the push/turn control to set the switch-on time to 7:30.</p>	
<p>3. Switch off at 18.00 hrs Mo-Fr Using the push/turn control select the symbols “Mo-Fr off” (workday group). Hold down the SET key and use the push/turn control to set the switch-off time to 18:00.</p>	
<p>4. Switch on at 10.00 hrs Sa Using the push/turn control select the symbols “Sa on”. Hold down the SET key and use the push/turn control to set the switch-on time to 10:00.</p>	
<p>5. Switch off at 14.00 hrs Sa Using the push/turn control select the symbols “Sa off”. Hold down the SET key and use the push/turn control to set the switch-off time to 14:00.</p>	

10 Programme operation

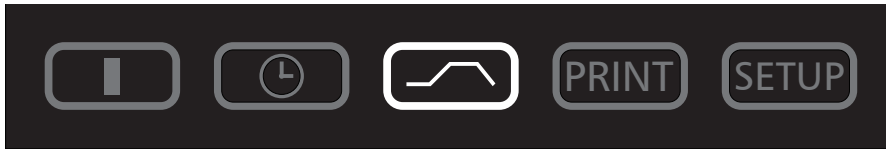

In this operating mode, up to 40 freely programmable temperature-time ramps can be set. Rotating the press/turn control while holding down the SET key selects the following parameters in sequence after released the SET key:

- a new programme can be programmed or an existing programme can be edited



- stops the programme



- starts the programme



After EDIT  has been activated, the following parameters can be selected and can be altered as described in the [Section "Selecting the parameters"](#):



Delayed programme start: switch-on day

Range: Monday to Sunday, workdays Mo-Fr, weekend Sa-Sun, all days Mo-Su or no day. If no day of the week is selected, the oven starts up immediately after the programme is started. (**INSTANT START**)

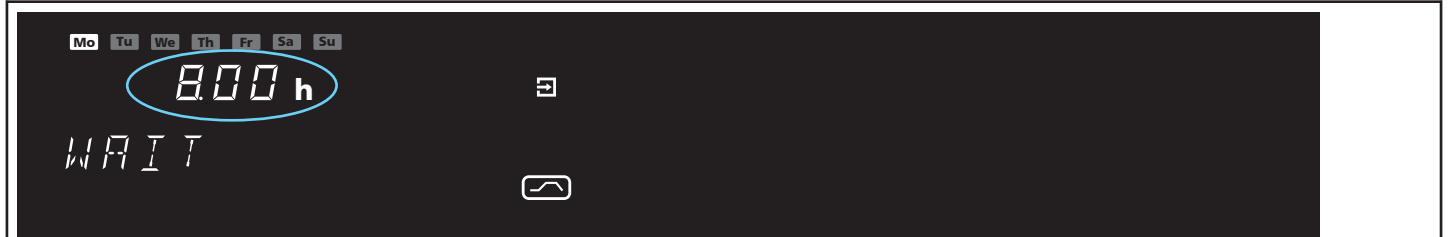

Delayed programme start: switch-on time

Range: 00:00 to 23:59

If no switch-on day has been selected it is not possible to select a switch-on time, and the programme starts immediately. (**INSTANT START**)

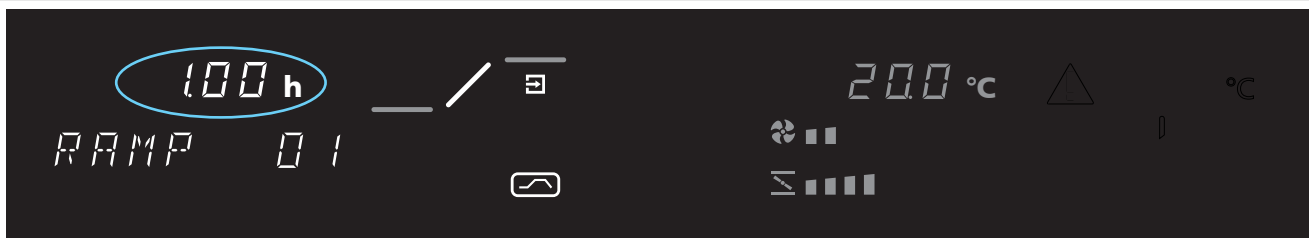

Duration of first ramp segment
Range: 1 minute to 999 hours.

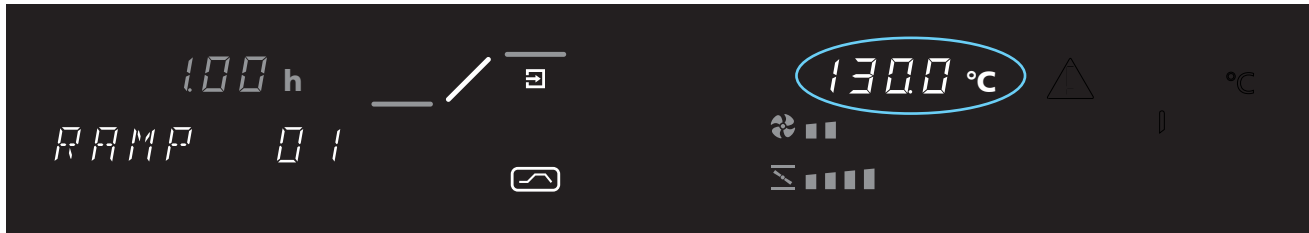

Setpoint temperature / temperature at the end of the ramp segment
Range: 20 °C to nominal temperature (details see label)

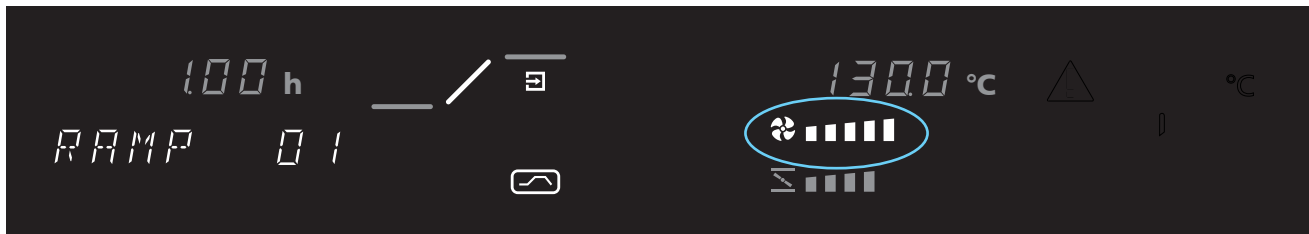

Fan speed during the ramp segment
Range: 0 to 100%

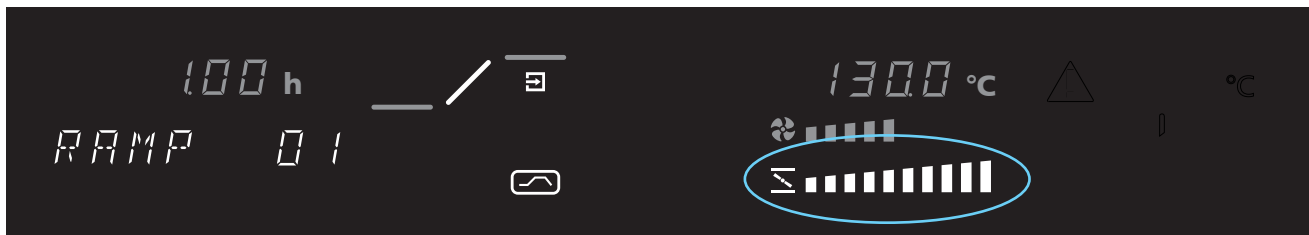

Air valve opening during the ramp segment
Range: 0 to 100%

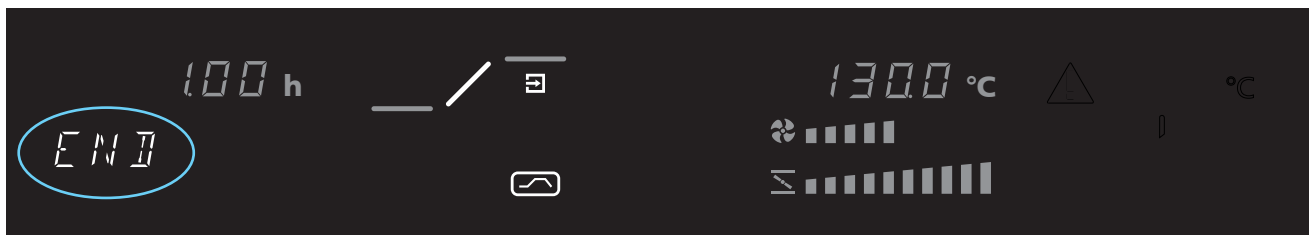



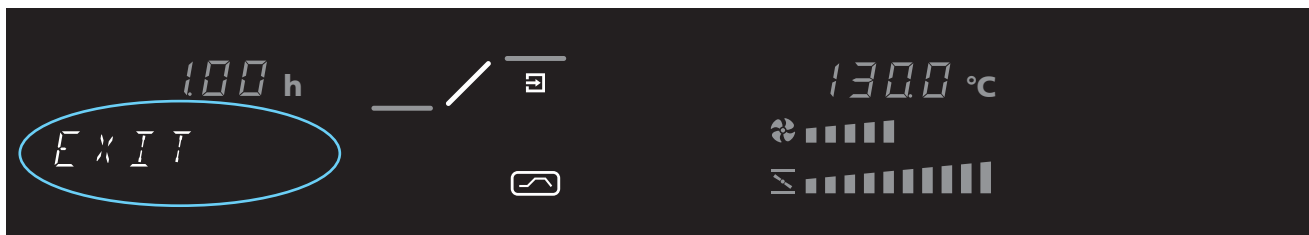

Closure command of ramp segment
Range: _NEXT, SPWT, LOOP, HOLD, END (see Section „Closure commands for ramp segments“)



Exit the programme write mode EDIT
Turn the push/turn control clockwise until EXIT appears on the display, briefly press the SET key to enter.

10.1 Closure commands for ramp segments

<p>NEXT</p> 	<p>Follow-on with next programme segment.</p>
<p>SPWT (T)</p>  <p>SET-POINT WAIT</p>	<p>Wait until the setpoint temperature is reached. The oven only starts the next programme segment when the programmed setpoint temperature has been reached, even if the programmed heating time has already elapsed.</p>
<p>LOOP</p> 	<p>Ramp repeat function. The set programme is repeated after passing through all programmed segments. 1-99 = repeats CONT = continuous repeat function</p>
<p>HOLD</p> 	<p>End of programme without switching off the heating; temperature and all other settings (e.g. air valve) are maintained.</p>
<p>END</p> 	<p>End of programme, heating is switched off, all other settings (e.g. air valve) are reset to base status.</p>

The programme segments are linked together by the segment closure command. These commands therefore control the programme sequence.

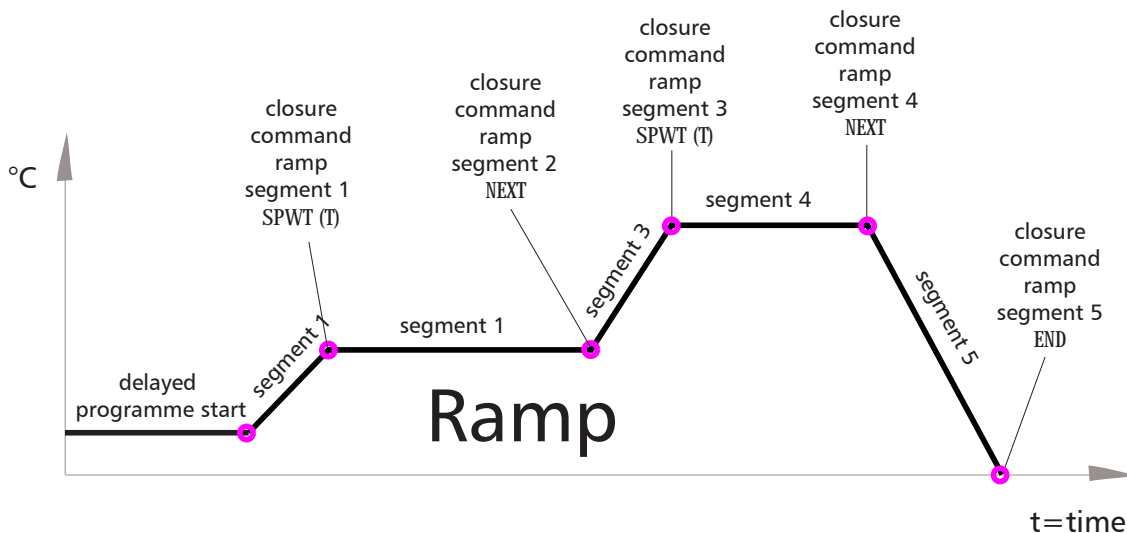





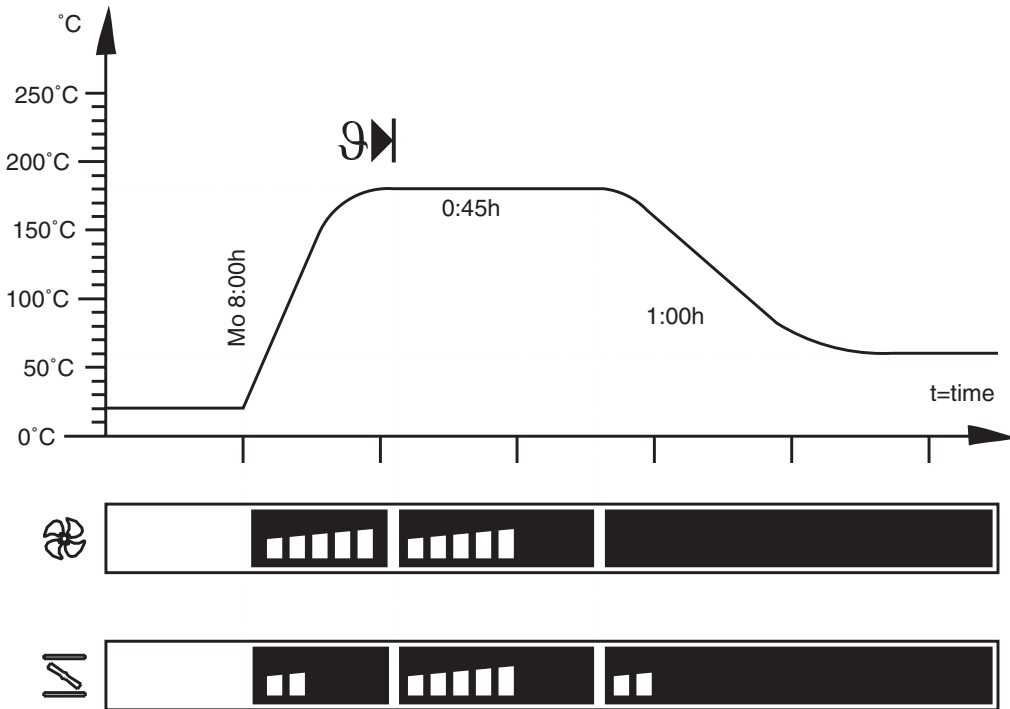





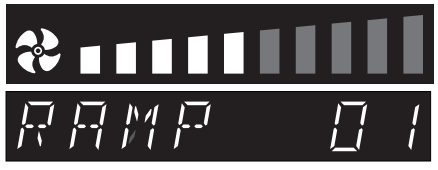





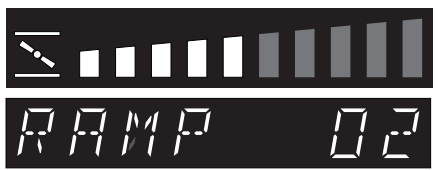

Programming example programme operation

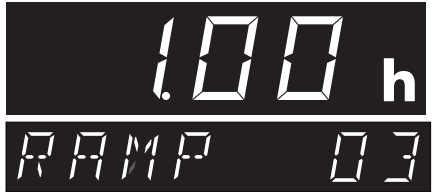
The oven (UFP500) has to heat up as quickly as possible to 180°C on Monday at 08.00 hrs with a fan speed of 50% and the air valve open 20%. The oven has to hold this temperature for 45 minutes with the air valve 50% open, followed by cooling down in one hour to 60°C with fan switched off and the air valve open 20%.



<p>1. Select operating mode "programme" After holding down the SET key (approx. 3 sec) the current operating mode is flashing. Hold down the SET key and select operating mode "programme" using the push/turn control. After the SET key has been released the controller is in operating mode "programme operation".</p>	
<p>2. Edit programme Hold down the SET key and turn the push/turn control to select "EDIT". After the SET key has been released, the controller is in the programme writing mode.</p>	
<p>3. Weekday for delayed programme start Hold down the SET key and turn the push/turn control to set the start day Mo.</p>	
<p>4. Select clock time for delayed programme start Using the push/turn control, select the time display. Hold down the SET key and set the time 08:00 using the push/turn control.</p>	

<p>5. Select duration of first ramp segment Turn the push/turn control further clockwise until the time of the first ramp segment is flashing. Hold down the SET key and set the time 00:01 using the push/turn control.</p>	
<p>6. Select temperature of first ramp segment Turn the push/turn control clockwise until the temperature display is flashing. Hold down the SET key and set the required temperature setpoint of 180 °C using the push/turn control.</p>	
<p>7. Select fan speed for first ramp segment Turn the push/turn control clockwise until the fan symbol is flashing. Hold down the SET key and set the fan speed to 50% using the push/turn control.</p>	
<p>8. Set air valve for first ramp segment Turn the push/turn control clockwise until the air valve symbol is flashing. Hold down the SET key and set the air valve to 20% using the push/turn control.</p>	
<p>9. Set closure command of first ramp segment Turn the push/turn control clockwise until a segment closure command (e.g. END) appears. Hold down the SET key and set SPWT [T] with the push/turn control.</p>	
<p>10. Select duration of second ramp segment Using the push/turn control select the time indication. Hold down the SET key and set the time 00:45 using the push/turn control.</p>	
<p>11. Select temperature of second ramp segment Turn the push/turn control clockwise until the temperature display is flashing. Hold down the SET key and set the required temperature setpoint of 180 °C using the push/turn control.</p>	
<p>12. Select fan speed for second ramp segment Turn the push/turn control clockwise until the fan symbol is flashing. Hold down the SET key and set the fan speed to 50% using the push/turn control.</p>	
<p>13. Set air valve for second ramp segment Turn the push/turn control clockwise until the air valve symbol is flashing. Hold down the SET key and set the air valve to 50% using the push/turn control.</p>	

<p>14. Set closure command for second ramp segment Turn the push/turn control clockwise until a segment closure command (e.g END) appears. Hold down the SET key and set NEXT with the push/turn control.</p>	
<p>15. Select duration of third ramp segment Using the push/turn control select the time indication Hold down the SET key and set the time 08:00 using the push/turn control.</p>	
<p>16. Select temperature of third ramp segment Turn the push/turn control clockwise until the temperature display is flashing. Hold down the SET key and set the required temperature setpoint of 60 °C using the push/turn control.</p>	
<p>17. Select fan speed for third ramp segment Turn the push/turn control clockwise until the fan symbol is flashing. Hold down the SET key and set the fan speed to 50% using the push/turn control.</p>	
<p>18. Set air valve for third ramp segment Turn the push/turn control clockwise until the air valve symbol is flashing. Hold down the SET key and set the air valve to 20% using the push/turn control</p>	
<p>19. Set closure command for third ramp segment Turn the push/turn control clockwise until a segment closure command (e.g END) appears. Press the SET key briefly to enter.</p>	
<p>20. Exit programme writing mode EDIT Turn the push/turn control clockwise until EXIT appears on the display. Press the SET key briefly to enter.</p>	
<p>21. Set temperature monitor Turn the push/turn control clockwise and set the temperature monitor. (see Section "Temperature monitor")</p>	
<p>22. Start programme Turn the push/turn control anticlockwise until the stop symbol ■ is flashing. Hold down the SET key and select Start ► with the push/turn control.</p>	

11 Printer PRINT



All PERFECT ovens are fitted as standard with a parallel printer interface, as used on personal computers.

This parallel printer interface on the back of the oven is suitable for connecting conventional PCL3-compatible ink jet printers which are provided with a parallel printer interface (e.g. HP Deskjet 5550 or HP Deskjet 9xx).

It is important to use a screened interface cable. The screen must be connected to the plug case.

The controller is provided with an internal report memory (see Section „Report memory“). The report data can in this operating mode be printed out through the printer connected to the oven.

When using a colour printer, the various graphics can be printed in colour.

On the printout the GLP data head is also printed automatically and contains the following information:

- Printing date
- Time period of report
- Running page number
- Serial number and oven designation

By turning the push/turn control the following parameters can be selected in turn and altered as described in the Section „Setting the parameters“.

Reading the date of the first print page	
Reading the date of the last print page	
Start graphics print	
Print programme and configuration page	
Exit print menu and back to main menu	







12 Basic oven settings SETUP



In this operating mode it is possible to make the basic settings of the oven. Clock time, date, day, year, and settings of sounder, of address assignment, monitoring units, heater power and calibration are set here.

The following parameters can be selected by turning the push/turn control, and altered as described in the [Section „Setting the parameters“](#):

<u>Clock time in 24-hour format</u> The winter/summer time changeover does not take place automatically but must be set manually by the user.	10.56 h SET TIME
<u>Date</u> The controller incorporates a calendar which automatically allows for the different lengths of the months and also for leap years.	28.06 SET DATE
<u>Weekday</u>	Mo SET DAY
<u>Year</u> Range: from 2000 to 2100	2008 SET YEAR
<u>Audible signal at programme end</u> Setting: OFF or ON	OFF On END SOUND
<u>Audible signal on alarm, e.g. overtemperature</u> ALARM SOUND Setting: OFF or ON	OFF On ALARM SO
<u>Communication address</u> Range: 0 to 15 (see Section „Communication interface“)	ADDRESS
<u>Ratio of top to bottom heat</u> Range: -50% to +50% (see Section „Balance“)	BALANCE

<p><u>Heater power reduction</u> for gentle heating of the load and reduction of the mean current taken from the power supply.</p> <p>Note: reduction in heater power may lead to high temperatures no longer being achieved.</p> <p>Range: 50 to 100%</p>	
<p><u>Tolerance margin ASF</u> Range: Universal ovens Uxx 2 to 20 Sterilisers Sxx 2 to 20 Incubator Ixx 0.5 to 5 (see Section „Temperature monitor“)</p>	
<p><u>Temperature monitor function</u> Adjustable temperature monitor (TWW) Protection Class 3.1 to DIN 12 880</p> <p>Adjustable temperature limiter (TWB) Protection Class 2 to DIN 12 880</p> <p>(see Section „Temperature monitor“)</p>	 
<p><u>Language</u> Settings: GERMAN, ENGLISH, FRANCAIS, ESPANOL and ITALIANO</p>	
<p><u>Calibration correction for user-calibration</u> CAL1 to CAL3 ADJUST – TEMPERATURE CALIBRATION READJUST – TEMPERATURE CORRECTION (see Section „Calibration“)</p>	
<p><u>Exit setup mode</u> = store all settings and exit SETUP mode.</p>	

12.1 Real-time clock

The real-time clock is set in SETUP and includes date and clock time.

The real-time clock serves for documentation according to GLP.

Date and clock time are marked in the report print.

On the graphics print the time axis is marked in real-time.

The clock runs with a buffer battery independently of the mains power supply.

The built-in lithium battery Type CR 2032 has a life of approx. 10 years.

13 Temperature monitor and protection devices

The monitor temperature is measured with a separate PT100 temperature sensor inside the chamber. The monitor unit provides protection for the oven load as well as protection for oven and its surroundings.

The oven is provided with duplicate overtemperature protection (mechanical / electronic) according to DIN 12 880.

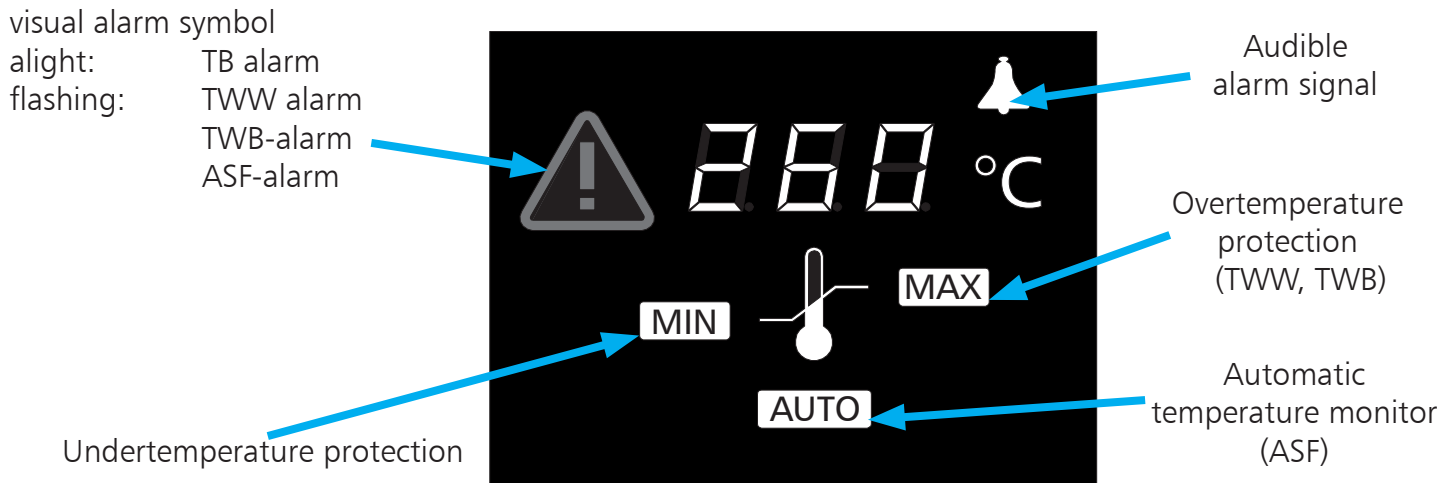

13.1 Mechanical temperature monitor: temperature limiter (TB)

All ovens of the PERFECT series are equipped with a mechanical temperature limiter (TB) Protection Class 1 to DIN 12 880.

If the electronic monitor system should fail during operation and the fixed factory-set maximum temperature is exceeded by approx. 20°C the temperature limiter switches off the heating permanently as a final protective measure. The alarm symbol lights up as warning 

Fault rectification after the TB cut-out has been activated:

1. Switch off the oven and allow it to cool down
2. Rectify the fault (e.g. replace temperature probe) and where appropriate contact customer service
3. The oven is again ready for operation only after it has cooled down and after the fault has been rectified

13.2 Electronic temperature monitor

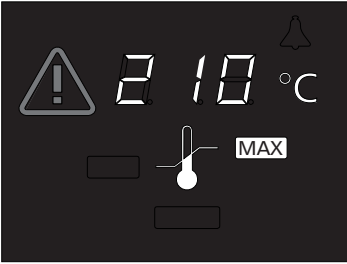
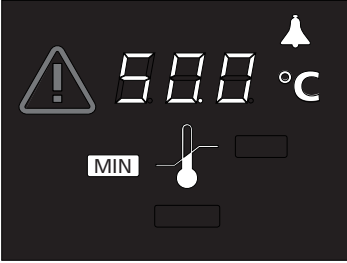
<p><u>13.2.1 Overtemperature protection</u> MAX</p> <p>Range: up to 10°C max above nominal temperature (for nominal temperature see label)</p>	 <p>The image shows a digital display with a warning triangle on the left, the number '210' in the center, and '°C' on the right. Below the display is a thermometer icon with a 'MAX' label next to it. There are two empty rectangular boxes below the thermometer icon.</p>	<p>Using the push/turn control select the symbol MAX-Symbol anwählen. Hold down the SET key and set the protection temperature using the push/turn control.</p>
<p><u>13.2.2 Undertemperature protection</u> MIN</p> <p>Range: from 10°C below minimum temperature of oven to 10°C above nominal temperature of oven (for nominal temperature see label).</p> <p>The low alarm cannot be programmed above the value set as high alarm.</p> <p>Where no undertemperature protection is required, this has to be set to the lowest temperature.</p>	 <p>The image shows a digital display with a warning triangle on the left, the number '500' in the center, and '°C' on the right. Below the display is a thermometer icon with a 'MIN' label next to it. There are two empty rectangular boxes below the thermometer icon.</p>	<p>Using the push/turn control select the symbol MIN. Hold down the SET key and set the protection temperature using the push/turn control.</p>

Note:

The temperature monitor can be set independently of the operating mode.

During ramp operation the monitor temperature must always be set sufficiently far above the maximum working temperature.

The manually set monitor temperature and the electronic overtemperature protection are monitored on PERFECT incubators by an adjustable temperature monitor (TWW) Protection Class 3.1 to DIN 12 880, or by an adjustable temperature limiter (TWB) Protection Class 2 to DIN 12 880. The choice of temperature monitor is selected in SETUP (see the menu item Tolerance margin ASF in Section „Basic oven settings“)

13.2.3 Adjustable temperature monitor (TWW) Protection Class 3.1 to DIN 12 880

If the manually set monitor temperature **MAX** is exceeded, the TWW takes over the control of the temperature and starts to control at the monitor temperature. As a warning the alarm symbol  is flashing.

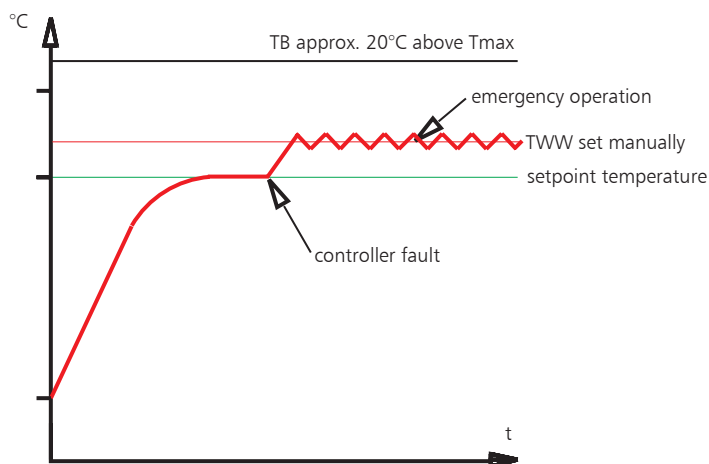

13.2.4 Adjustable temperature limiter (TWB) Protection Class 2 to DIN 12 880

If the manually set monitor temperature **MAX** is exceeded, the TWB switches off the heating permanently and can only be reset by pressing the SET key. As a warning the alarm signal  is flashing.

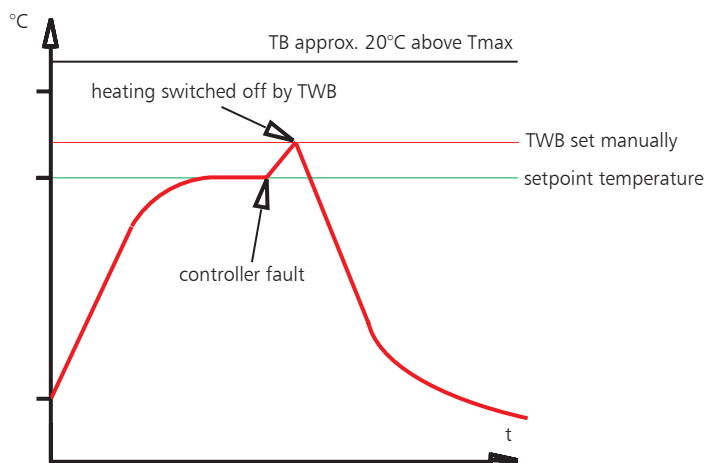

13.2.5 Automatic temperature monitor (ASF) **AUTO**

A monitoring device which automatically follows the selected temperature setpoint.

The tolerance margin of the ASF is set in SETUP (see the menu item [Tolerance margin ASF](#) in the Section „Basic oven settings SETUP“).

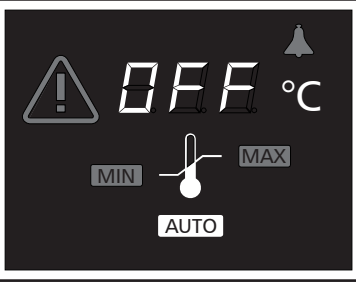
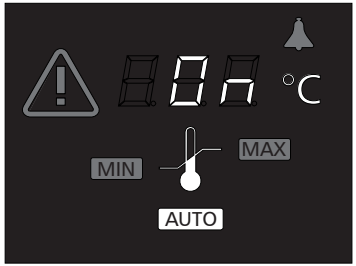
<p>Automatic temperature monitor OFF (ASF OFF)</p>		<p>Using the push/turn control select the AUTO symbol. Hold down the SET key and select OFF using the push/turn control.</p>
<p>Automatic temperature monitor ON (ASF ON)</p>		<p>Using the push/turn control select the AUTO symbol. Hold down the SET key and select ON using the push/turn control.</p>

Notes on the ASF:

The tolerance margin for the ASF is selected in SETUP (see the menu item [Tolerance margin ASF](#) in the Section „Basic oven settings SETUP“).

Tolerance margin reached = ASF activated

The ASF is automatically activated when the actual temperature has reached 50% of the selected tolerance margin of the setpoint (in the example 150°C – 5°C).

The activation of the automatic temperature monitor is indicated by the bright **AUTO**-symbol.

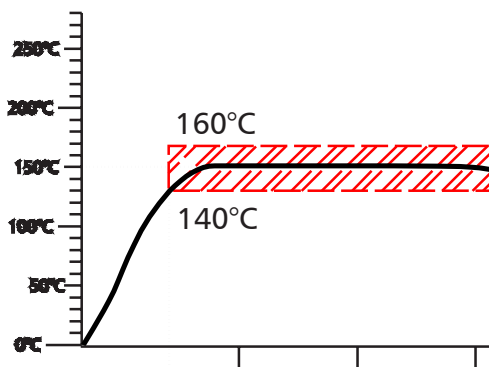

ASF set to
+/-10°C in
SETUP

ASF activated ASF activated

ASF alarm

Going outside tolerance margin = ASF alarm

Going outside the selected tolerance margin of the setpoint (in the example $150^{\circ}\text{C} \pm 10^{\circ}\text{C}$), for example through opening the oven door during operation, triggers the alarm.

Triggering the ASF alarm is indicated by flashing **AUTO** and -symbol.

If the sounder is switched on in SETUP, the ASF alarm is additionally signalled by an interrupted tone. By pressing the SET key the sounder can be switched off temporarily until the next occurrence of an alarm event.

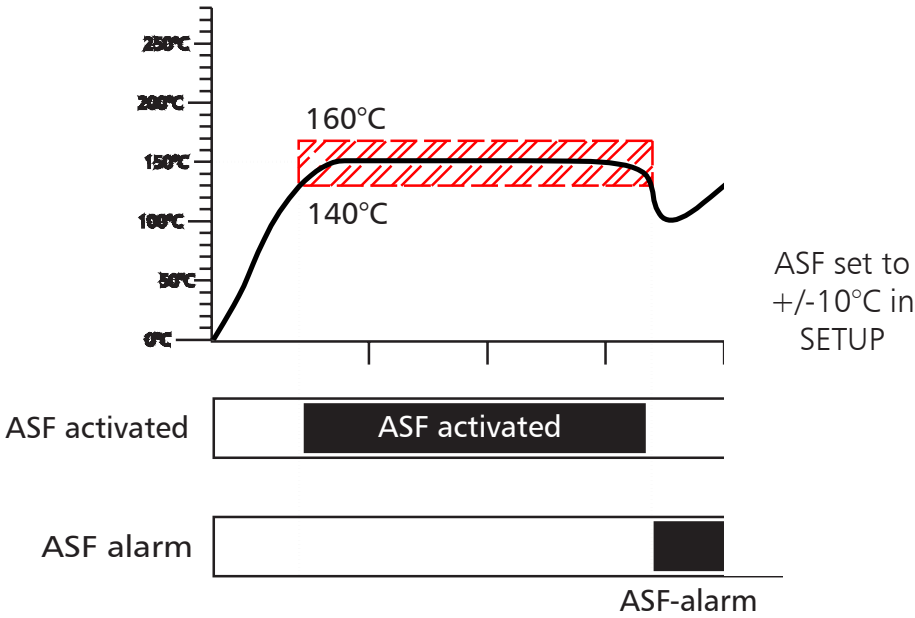

Again within tolerance margin = ASF alarm switched off

The automatic temperature monitor alarm is switched off automatically as soon as the selected tolerance margin of the setpoint (in the example $150^{\circ}\text{C} \pm 10^{\circ}\text{C}$) is reached again.

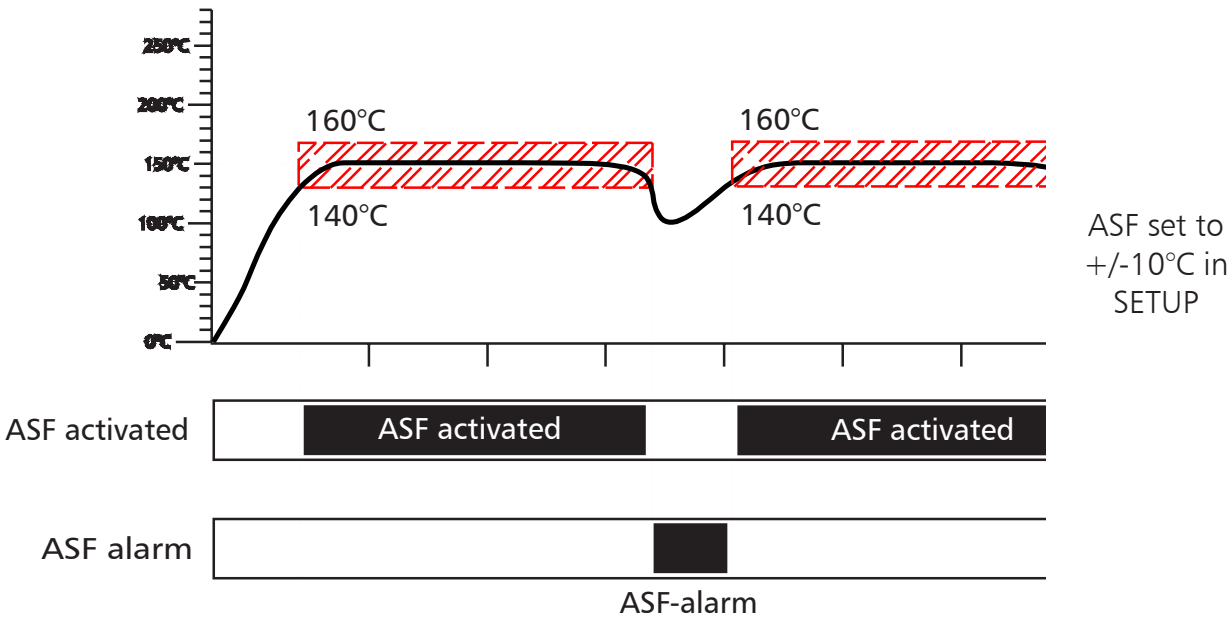

Setpoint changed = ASF de-activated automatically

If the temperature setpoint is altered, the automatic temperature monitor is automatically de-activated temporarily (see in the example the setpoint is changed from 150°C to 75°C) until the tolerance margin of the new temperature setpoint is reached (see in the example below: the ASF is re-activated at 75°C +/- 10°C).

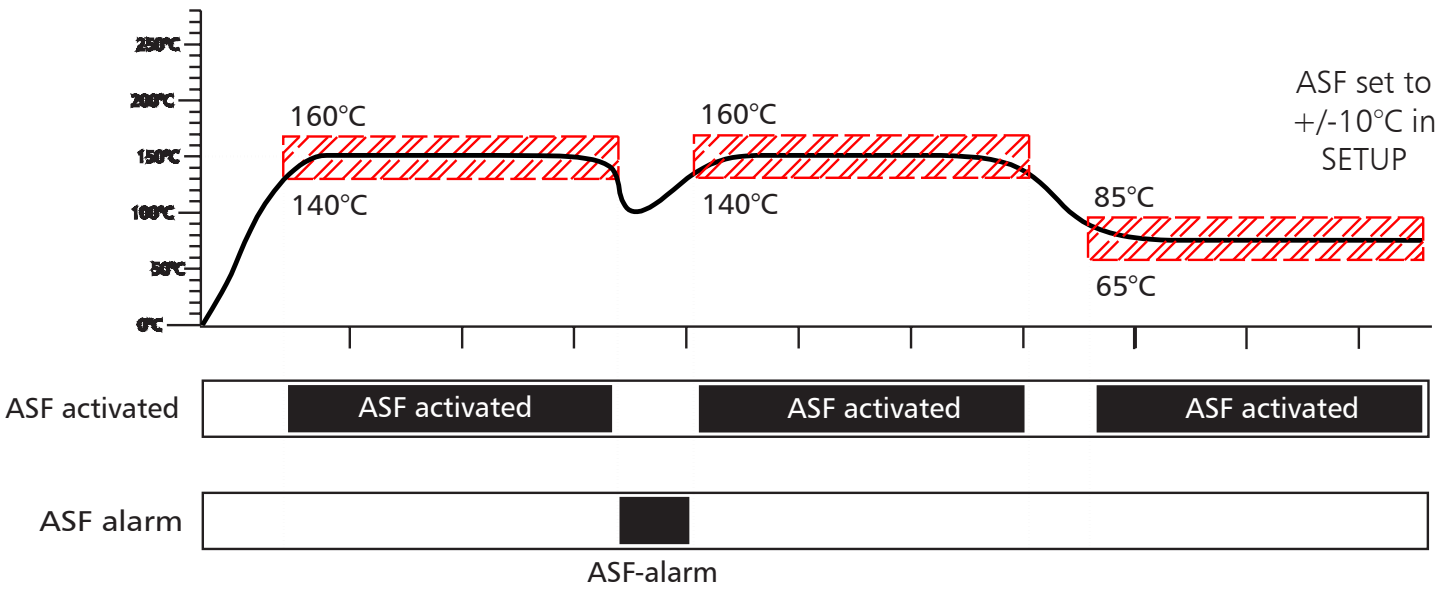

14 Calibration

User-calibration of oven and controller, with three calibration temperatures selected by the user.

CAL1 temperature calibration at low temperature

CAL2 temperature calibration at medium temperature

CAL3 temperature calibration at high temperature

Either a positive or a negative calibration correction can be applied to each selected calibration point.

General calibration instructions:

1. Select the required calibration temperature in SETUP and set the corresponding calibration correction to 0.0°C.
2. Measure the deviation from the selected calibration temperature under steady conditions, using a reference instrument.
3. Set the calibration correction in SETUP. If the measured reference temperature is too low, the calibration correction setting has to have a negative sign.
4. Carry out a check measurement using the reference meter.
5. The procedure can be carried out for up to 3 calibration temperatures.

Example: Correction of a temperature deviation in the load at 100°C.

1. Set calibration temperature **CAL2** to 100.0°C in SETUP and set the corresponding calibration correction to 0.0°C.
2. Using a calibrated reference instrument, an actual temperature of 99.6°C is measured in normal operation for a setpoint temperature of 100°C.
3. In SETUP set the calibration correction for **CAL2** to -0.4°C.
4. After the oven has settled down the reference instrument should read 100.0°C.
5. With **CAL1** a further calibration temperature can be programmed below **CAL2**, and with **CAL3** an additional calibration temperature above **CAL2**.

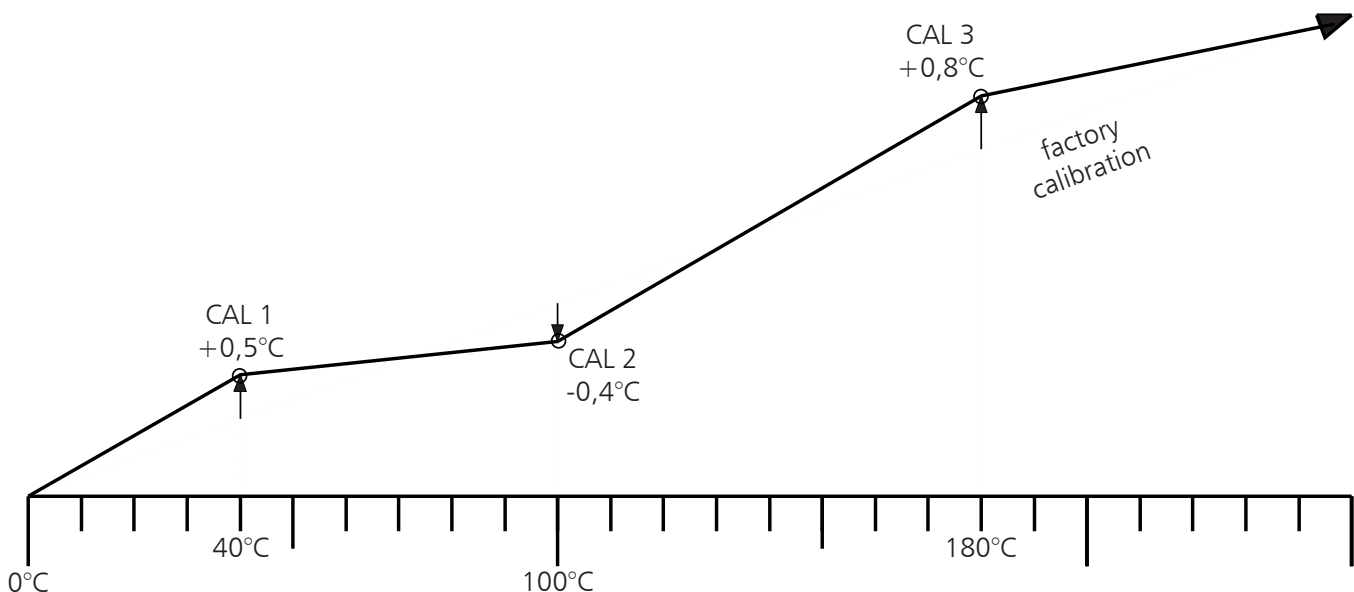

Note:

If all calibration corrections are set to 0.0°C the factory calibration is restored.

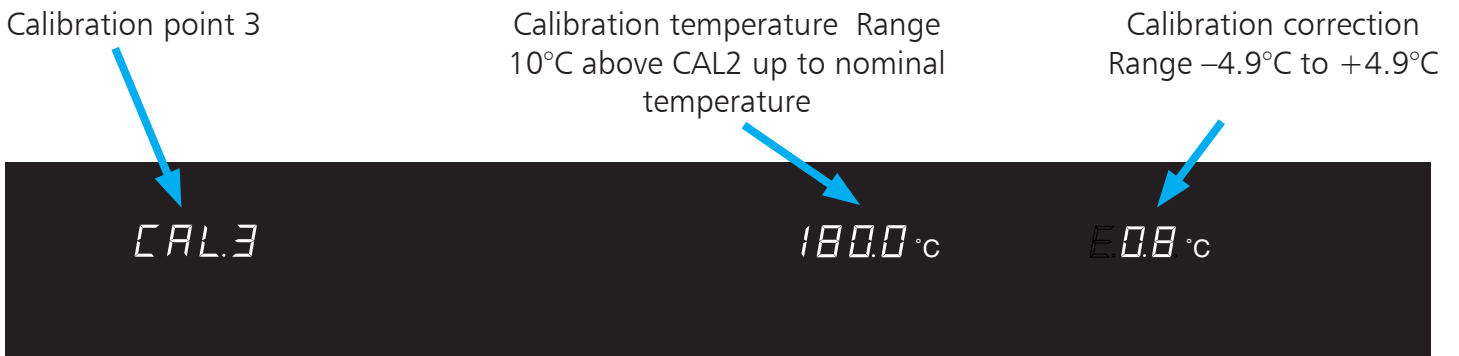
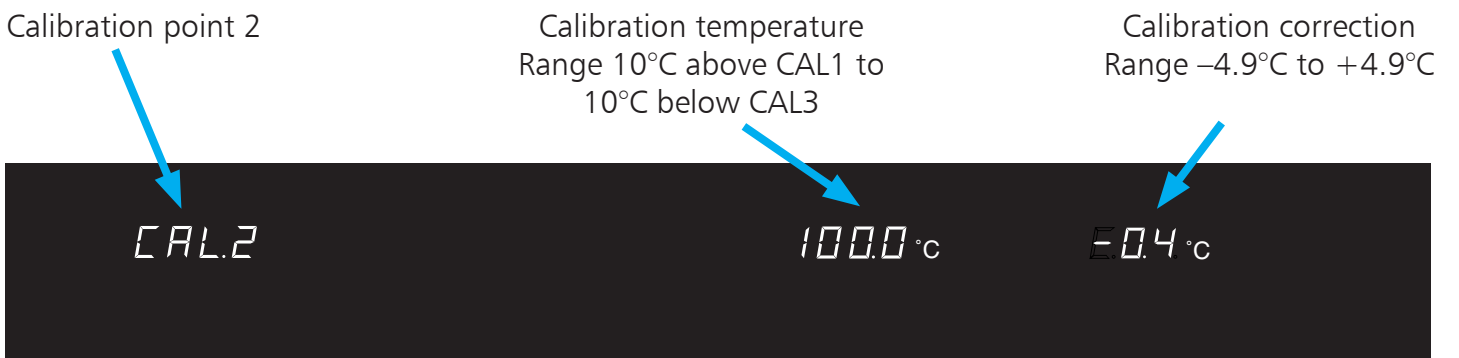
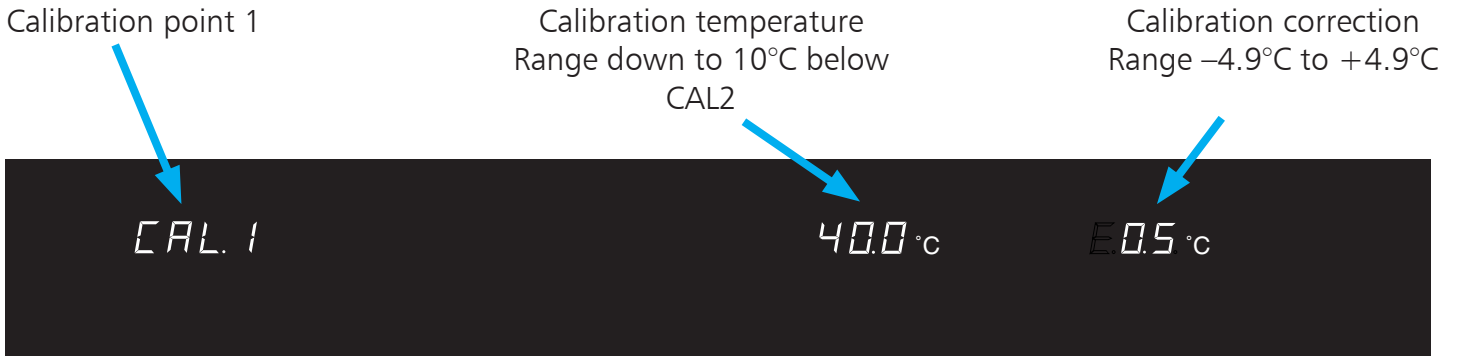

15 Communication interface for the PC

15.1 Communication interface RS232C

The oven is provided as standard with a serial communication interface RS232C according to DIN 12 900-1. Using this interface it is possible to control the oven from the PC and to produce reports. This is done using the "Celsius 2007" software.

For this purpose the oven has to be assigned a unique device address in sub-menu SETUP, option ADDRESS; This is the address through which the PC communicates with the oven. The default setting is ADDRESS 0. Using this address each oven can be addressed by the PC and programmed.

If several ovens are connected by the RS232C interface to one PC, each oven requires a corresponding interface on the PC as well as a separate cable.

The maximum cable length is 15 m.

For connection of the oven to the PC there is a 9-pin connector on the back of the oven. The oven can be connected to the PC using a screened interface cable. The screen has to be connected to the plug case. If the serial interface is not being used, the cover supplied has to be fitted !

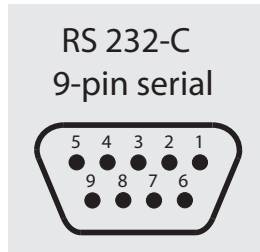

1	2	3	4	5	6	7	8	9
not used	RXD	TXD	not used	GND	not used	not used	not used	not used

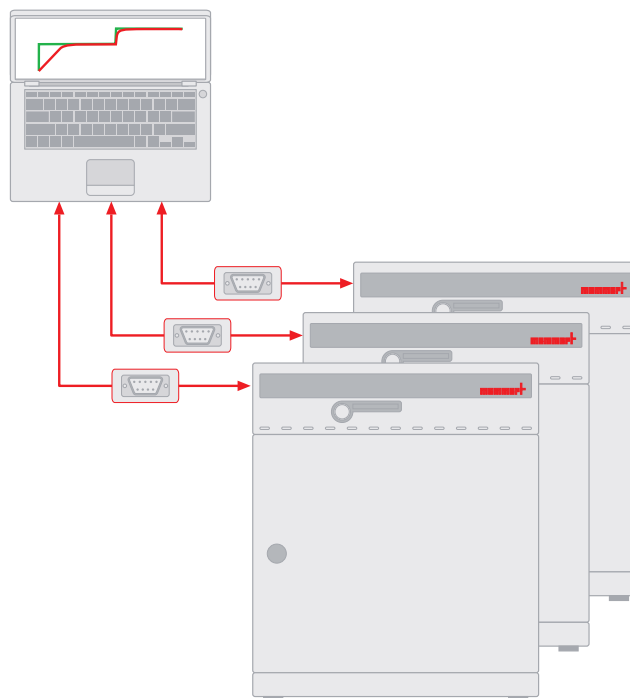

15.2 Bus interface RS485

When so ordered, the oven can be equipped at the factory with an RS485 interface instead of the RS232C interface. This permits networking of several ovens (up to 16) with a single PC using a common 2-wire circuit. The system is operated using the "Celsius 2007" software. A unique device address has to be assigned to the oven in sub-menu SETUP, option **ADDRESS**. This is the address through which the PC communicates with the oven. The default setting is **ADDRESS 0**. Using this address each oven can be addressed by the PC and programmed.

For this purpose the PC must be equipped with an RS485 interface or must be fitted with an RS232/RS485 converter. The cabling has to suit the individual location using a screened cable. The maximum total length of the cable is 150 m.

A maximum of 16 devices can be addressed on the RS485 bus. A termination resistance of 220 Ohm has to be connected to the last device.

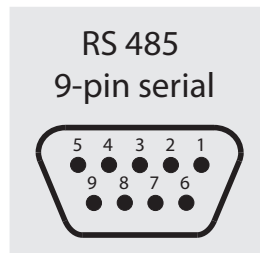

1	2	3	4	5	6	7	8	9
not used	not used	A	not used	not used	not used	not used	B	not used

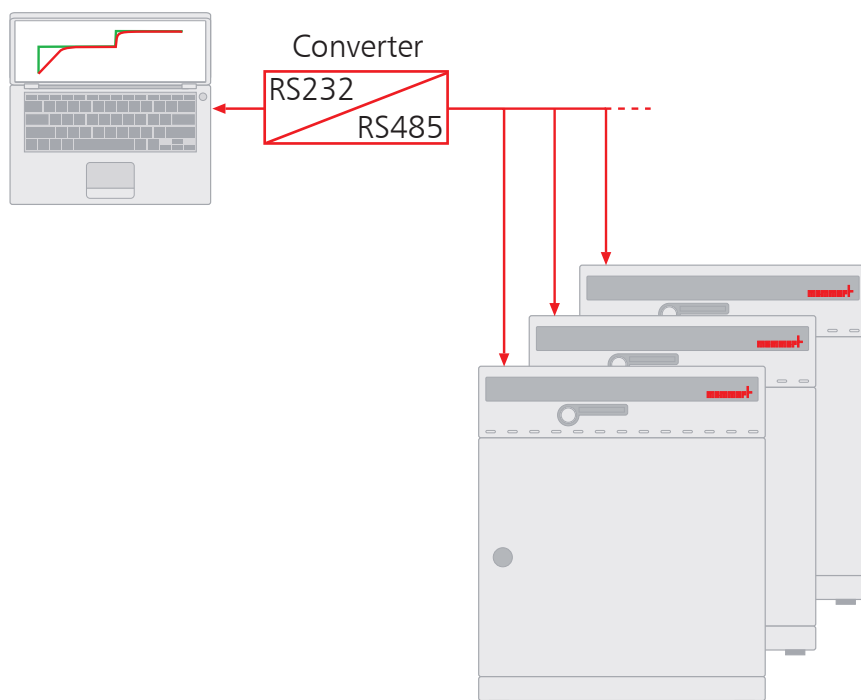

16 Heating power distribution BALANCE

On ovens series INP 500-800 and UNP/UFP 400-800 it is possible in SETUP to correct the heating power distribution BALANCE between the top and bottom heater groups to suit the individual application. The adjustment range is -50% to $+50\%$.

The setting 0% restores the factory-set heating power distribution.

top
heater power

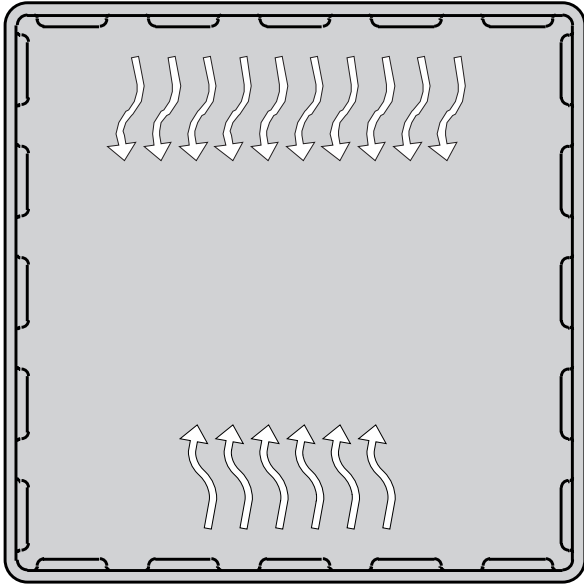

bottom heater
power
 -20%

Example 1:

With the setting -20% the bottom heater groups heat with 20% less power than the top heater groups.

top
heater power

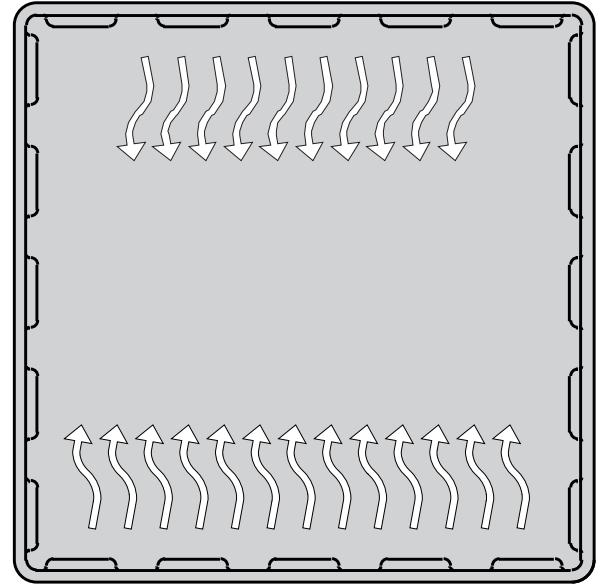

bottom heater
power
 $+30\%$

Example 2:

With the setting $+30\%$ the bottom heater groups heat with 30% more power than the top heater groups.

17 Report memory

The controller continuously records all relevant measurements, settings and error messages at 1-minute intervals.

The internal report memory is arranged as a ring memory, i.e. the new data always overwrite the oldest report data.

The report function can not be switched off but remains active at all times. The data are stored in the controller, protected against any manipulation. The controller memory can be read to produce documentation.

Every data set is stored with a unique date stamp.

The size of the internal report memory is 1024kB. This corresponds to a memory capacity of approximately 6 months' continuous operation.

During ramp operation a larger amount of data are stored in the memory so that the maximum report duration may be reduced.

If the power supply is interrupted, the instants of power failure and restoration of power are stored in the controller.

17.1 Reading the report memory

Past report data can be printed either via the RS232C interface or by a PLC3-compatible printer connected to the oven.

17.2 Reading the report memory into the PC via RS232C

Using the "Celsius 2007" program the record memory of the controller can be read via the RS232C interface into a PC where it can be shown graphically, printed, and stored in memory.

Note:

The report memory of the controller is not altered or cleared by the reading procedure.

17.3 Printing the report memory from the oven

(see Section „Printer“)

If the printer is not ready, e.g. cartridge empty or no paper, no report data are lost. Prints can be repeated several times since the report memory is not cleared after printing.

The GLP data header is automatically included in the print-out: it contains the following information:

- Printing date
- Time period of report
- Running page number
- Serial number and oven designation

18 Memory card: MEMoryCard XL

A temperature programme with up to 40 ramps can be programmed on the MEMoryCard XL. Programming can take place directly on the controller or through the PC program "Celsius 2007".

For improved clarity it is recommended that extensive programmes are prepared graphically on the PC. Where a MEMoryCard XL is programmed, it can be read only on the same oven type for which it has been programmed.

Marking:

The text field of the MEMoryCard XL can be marked individually with text or diagram



18.1 Programming the MEMoryCard XL from the oven

Insert the MEMoryCard XL into the slot in the control panel field.

The selected settings are written directly to the card and stored on it. After the card has been removed, the programme stored internally in the controller becomes again activated.

18.2 Programming the MEMoryCard XL from a PC with the oven

Link the PC to the oven with an interface cable via the serial interface (see Section „Communication interface“). Insert the MEMoryCard XL into the input slot in the control panel field.

Write protection:

The Memory Card XL can be provided with write protection using the PC program "Celsius 2007". The programme on the card can then not be altered on the controller.

18.3 Programming the MEMoryCard XL from a PC using the read-write unit

Using a read-write unit (which can be purchased separately) the MEMoryCard XL can be programmed from a PC with "Celsius 2007" without any connection to an oven. It is important to ensure that the MEMoryCard XL has to be inserted with the contact field pointing upwards towards the marking of the read-write unit.

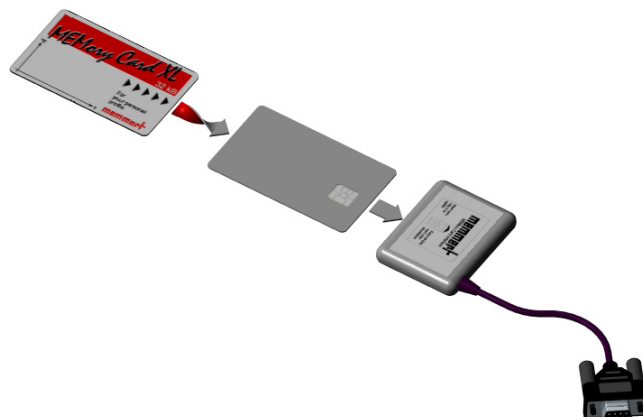

Note:

The programme remains stored on the Memory Card XL after the card has been removed from the unit. It can however be overwritten at any time by the PC using "Celsius 2007".

Details on programming the MEMoryCard XL with PC and „Celsius 2007“ can be found in the „Celsius 2007“ Operating Manual and in the Online Help.

18.4 Documentation on memory card MEMoryCard XL

The actual temperatures can be documented continuously on the memory card while the programme is running from the chip card. After the programme has been completed they can be read and printed using "Celsius 2007". The operation is described in the "Celsius 2007" Operating Manual.

A certain amount of storage space is provided for documentation depending on the programme duration. The sampling rate is set automatically by the controller depending on the programme duration. With a programme duration up to 270 hours the documentation of the actual values on the MEMoryCard XL takes place with a 1-minute cycle. With programmes of longer duration the sampling time is extended up to 30 min max.

Documentation is started afresh on each programme start; the old report data are overwritten.

19 Sterilisation chip card (for INP incubators only)



The STERICard starts an automatic and preset sterilisation process.

The automatic sterilisation process starts as soon as the STERICard is inserted into the oven and started by the user.

- Ramp 1: heating to 160°C
- Ramp 2: hold for 4 hours (after the sterilisation temperature has been reached)
- Ramp 3: cooling to 70°C
- Ramp 4: wait 10 minutes

After successful sterilisation the control displays **STERILISATION OK**.

The air valve remains closed during the entire sterilisation sequence.

The automatic sterilisation programme can not be altered by the user. For documentation purposes the sterilisation process can be reported on the STERICard and can be read using „Celsius 2007“.



Important note:

On incubators the sterilisation programme does not serve for sterilising the load but solely for sterilising the chamber. The incubator is not a steriliser within the scope of the medical product regulations.

20 User-ID-Card (available as optional extra)



The User-ID-Card stores the serial number of the oven and a unique user number in encrypted format. The User-ID-Card therefore functions only in the oven with the corresponding serial number.

Each log-on via the User-ID-Card is documented in the internal flash memory.

If the User-ID-Card is inserted, the **SETUP** menu includes the additional item **ID-LOCK**. When the setting is changed to **ON**, all changes to the oven are blocked after the chip card has been removed.

The blockage through the User-ID-Card is indicated by the illuminated key symbol  on the control panel.



Important:

If the oven is blocked through the User-ID-Card, there is no programme operation with the MEMoryCard XL since that card could be removed at any time and reprogrammed externally.

21 Sterilisers

21.1 Purpose definition for MEMMERT hot air sterilisers

The oven SFP is intended for the sterilisation of medical materials by dry heat using hot air at atmospheric pressure.

21.2 Notes in accordance with Medical Products Guidelines

For sterilisers in the context of the Law on Medical Products (MPG), the „Celsius“ software may only be used for logging purposes, but not for the remote control (remote operation) of devices.

The product lifetime specified by the manufacturer is 8 years.

21.3 Guidelines for sterilisation in MEMMERT hot air sterilisers

For hot air sterilisation there are different regulations covering the temperature settings and the sterilisation times, as well as the packaging of the products to be sterilised. The values to be selected depend on the type and condition of the load to be sterilised and on the type of bacteria which have to be de-activated. Please make yourself familiar with the sterilisation method laid down for your application before carrying out sterilisation using your MEMMERT cabinet.

The operation of the MEMMERT hot air steriliser is also subject to the Standard DIN 58 947 Part 6.

A few examples of the correct preparation for different medical products are summarised in the following table:

Load	Preparation
Instruments (no soft solder)	load cleaned instruments, wrapped twice in aluminium foil or in steriliser foil suitable for hot air (recommended)
Cutting instruments	load cleaned instruments, wrapped twice in aluminium foil or in steriliser foil suitable for hot air (recommended)
Syringes (no plastics)	load plunger and cylinder separately, wrapped twice in aluminium foil or in steriliser foil suitable for hot air (recommended)
Glass and glass instruments	dismantle cleaned glass vessels and all-glass syringes and place into dishes, cool down slowly

FBottles, vessels and similar items must be sterilised without closure and with the opening downwards, in order to avoid the formation of cold air pockets. The recommended sterilisation temperature is usually 180°C (German Pharmacopoeia DAB 10).

Sterilisation should in all cases be carried out as setpoint-dependent operation, according to the following example. The holding time to be selected consists of the stabilisation time (i.e. the time until the desired temperature has been established within the entire steriliser chamber), the actual sterilisation time, and a safety margin.

The following table gives typical values for the holding time to be set, with different amounts of load, for sterilisers with and without fan. Please note that these values can be employed only with correct and loose distribution of the load. Notes on the correct loading of the steriliser can be found in these Operating Instructions and also on the label affixed to the steriliser.

Sterilisation temperature: 180°C	Type of loading:					
	light		medium		heavy	
Steriliser size	without fan	with fan	without fan	with fan	without fan	with fan
200	0:50 h	----	1:20 h	----	1:50 h	----
300	0:50 h	----	1:20 h	----	1:50 h	----
400	1:15 h	1:00 h	1.50 h	1.20 h	2:00 h	1:50 h
500	1:15 h	1:00 h	1.50 h	1.20 h	2:00 h	1:50 h
600	1:30 h	1:00 h	2.20 h	1.30 h	2:20 h	2.20 h
700	1:30 h	1:00 h	2.20 h	1.30 h	2:20 h	2.20 h
800	1:40 h	1:10 h	2.20 h	1.40 h	2:50 h	2.20 h

The sterilisation time is increased by a factor of 4 when sterilising at a temperature of 160°C. On large sterilisers and with heavy loading it is recommended to use wire shelves (special accessory) instead of perforated shelves.

Especially with heavy loading of the steriliser it is not sufficient to use these typical values without further tests. Reliable sterilisation requires validation of the individual sterilisation process, e.g. with the aid of additional temperature probes or by using biological or chemical indicators.

Note:

In sterilisation processes the vent valve on the oven must be closed after the moist sterilisation load has been dried!



WARNING!







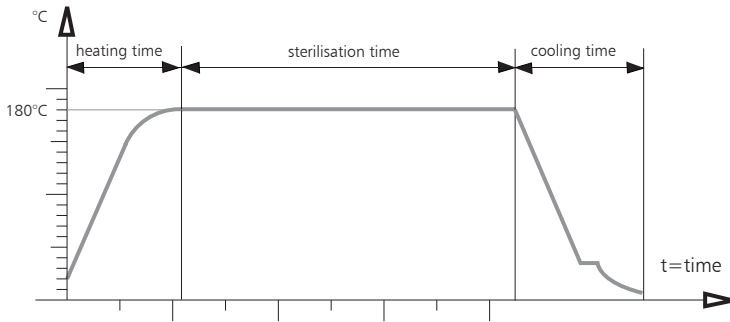





Models SFP 700/800 are fitted with lockable doors. If the user, against our express warning, enters the steriliser chamber he must first remove the key and carry it on his person.







Programming example steriliser



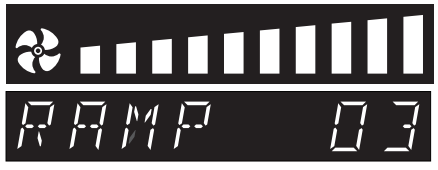
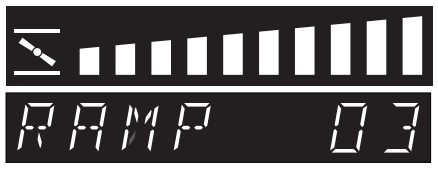

The steriliser (SFP600) has to sterilise at a temperature of 180°C and a medium quantity of load for one hour and 30 minutes. By setting a cooling time the load can only be removed after it has cooled down.

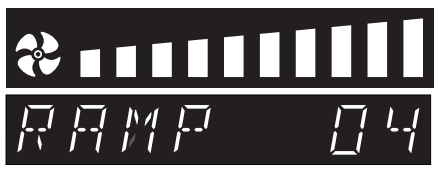

<p>1. Select operating mode "Programme" After holding down the SET key (approx. 3 sec) the current operating mode is flashing. Hold down the SET key and select operating mode "Programme" using the push/turn control. After the SET key has been released, the controller is in the "Programme" operating mode.</p>	
<p>2. Edit programme Hold down the SET key and turn the push/turn control to select "EDIT". After the SET key has been released, the controller is in the programme writing mode.</p>	
<p>3. Immediate programme start Hold down the SET key and turn the push/turn control to select INSTANT START.</p>	
<p>4. Select duration of first ramp segment Turn the push/turn control to select the time indication. Hold down the SET key and set the time 00:01 using the push/turn control.</p>	
<p>5. Set temperature of first ramp segment Turn the push/turn control clockwise until the temperature display is flashing. Hold down the SET key and set the required temperature setpoint of 180 °C using the push/turn control.</p>	
<p>6. Set fan speed for first ramp segment Turn the push/turn control clockwise until the fan symbol is flashing. Hold down the SET key and set the fan speed to 100% using the push/turn control.</p>	<p>The fan motor is running at maximum speed.</p>

<p>7. Set air valve for first ramp segment Turn the push/turn control clockwise until the air valve symbol is flashing. Hold down the SET key and set the air valve to 20% using the push/turn control.</p>	  <p>The air valve can be open for drying during heating.</p>
<p>8. Set closure command of first ramp segment Turn the push/turn control clockwise until a segment closure command (e.g. END) appears. Hold down the SET key and set SPWT [T] with the push/turn control.</p>	 <p>The segment closure command SPW [T] ensures that the sterilisation time starts only when the temperature of 180°C has been reached.</p>
<p>9. Select duration of second ramp segment Using the push/turn control select the time indication. Hold down the SET key and set the time 01:30 using the push/turn control.</p>	 
<p>10. Select temperature of second ramp segment Turn the push/turn control clockwise until the temperature display is flashing. Hold down the SET key and set the required temperature setpoint of 180 °C using the push/turn control.</p>	 
<p>11. Select fan speed for second ramp segment Turn the push/turn control clockwise until the fan symbol is flashing. Hold down the SET key and set the fan speed to 100% using the push/turn control.</p>	  <p>The fan is running at maximum speed.</p>
<p>12. Set air valve for second ramp segment Turn the push/turn control clockwise until the air valve symbol is flashing. Hold down the SET key and close the air valve using the push/turn control.</p>	  <p>The air valve is closed during sterilisation.</p>
<p>13. Set closure command for second ramp segment Turn the push/turn control clockwise until a segment closure command (e.g. END) appears. Hold down the SET key and set NEXT with the push/turn control.</p>	

<p>14. Select duration of third ramp segment Using the push/turn control select the time indication Hold down the SET key and set the time 00:01 using the push/turn control</p>	
<p>15. Select temperature of third ramp segment Turn the push/turn control clockwise until the temperature display is flashing. Hold down the SET key and set the required temperature setpoint of 30 °C using the push/turn control.</p>	
<p>16. Select fan speed for third ramp segment Turn the push/turn control clockwise until the fan symbol is flashing. Hold down the SET key and set the fan speed to 100% using the push/turn control.</p>	
<p>17. Set air valve for third ramp segment Turn the push/turn control clockwise until the air valve symbol is flashing. Hold down the SET key and set the air valve to 100% using the push/turn control.</p>	
<p>18. Set closure command for third ramp segment Turn the push/turn control clockwise until a segment closure command (e.g. END) appears. Hold down the SET key and set SPWT [T] with the push/turn control.</p>	 <p>The segment closure command SPW [T] ensures that sterilisation is terminated only after the unloading temperature has been reached.</p>
<p>19. Select duration of fourth ramp segment Using the push/turn control select the time indication Hold down the SET key and set the time 00:01 using the push/turn control</p>	
<p>20. Select temperature of fourth ramp segment Turn the push/turn control clockwise until the temperature display is flashing. Hold down the SET key and set the required temperature setpoint of 20 °C using the push/turn control.</p>	
<p>21. Select fan speed for fourth ramp segment Turn the push/turn control clockwise until the fan symbol is flashing. Hold down the SET key and set the fan speed to 100% using the push/turn control.</p>	

<p>22. Set air valve for fourth ramp segment Turn the push/turn control clockwise until the air valve symbol is flashing. Hold down the SET key and set the air valve to 0% using the push/turn control.</p>	 <p>The air valve is closed after sterilisation.</p>
<p>23. Set closure command for fourth ramp segment Turn the push/turn control clockwise until a segment closure command (e.g. END) appears. Turn the push/turn control clockwise until END appears on the display and press the SET key briefly to enter. If the audible signal at programme end ENDSOUND has been switched on in SETUP, the oven signals the end of sterilisation.</p>	 <p>When the temperature has reached 30°C, the display shows END after 1 minute. The load can now be removed. The fan continues to run at maximum speed.</p>
<p>24. Exit programme writing mode EDIT Turn the push/turn control clockwise until the display shows EXIT and press the SET key briefly to enter.</p>	
<p>25. Set temperature monitor Turn the push/turn control clockwise and set the temperature monitor, e.g. ASF +/-5°C. (see Section "Temperature monitor")</p>	
<p>26. Start the programme Turn the push/turn control anticlockwise until the stop symbol ■ is flashing. Hold down the SET key and select start ► using the push/turn control.</p>	

21.4 Steriliser cassettes

The cassettes should preferably be so arranged in the steriliser that the hot air flow can pass readily through the air slots.

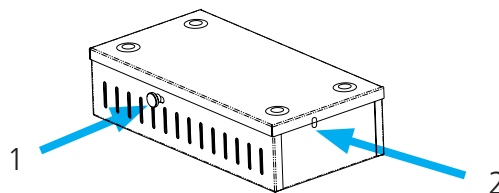

The load to be sterilised is placed into the steriliser cassettes wrapped in aluminium foil or in steriliser foil suitable for hot air (as in the Table in the Section "Guidelines for sterilisation"). The air slots in the cassette must be open for sterilisation.

A temperature probe to confirm the temperature of the load can be introduced through the opening (2). After sterilisation has been completed the air slots must be closed by moving the slide knob (1). The sterilised and packed load can then be stored briefly in the closed cassette.

22 Cleaning

Regular cleaning of the easy-to-clean inside of the chamber prevents deposits which over time can detract from the appearance and the functionality of the stainless steel chamber .

The metal surfaces of the oven can be cleaned with commercially available cleaning agents for stainless steel. It is important to ensure that no rust-forming object comes into contact with the chamber or the stainless steel casing. Rust deposits cause infection of the stainless steel.

If any contamination causes rust stains on the surfaces of the chamber, such spots must be cleaned off immediately and the area polished.

The control panel, the plastic input modules and other plastic components of the oven must not be cleaned using scouring cleaning agents or those containing solvents.

23 Maintenance

Important for a long life of your MEMMERT product and in case of warranty claims.

Note:

Any work involving opening up the oven must only be carried out by a suitably qualified electrician!

MEMMERT products require little maintenance. It is however recommended to lubricate all moving parts of the doors (hinges and closure) once a year (or 4 times a year with continuous operation) using a thin Silicone grease, and to check that the hinge screws are tight.

A well-closing door is essential on an oven. On MEMMERT ovens, tight closure of the door is ensured by a seal on the oven and another one on the door. In continuous operation the flexible sealing material may take a permanent set. Readjustment may then be necessary in order to ensure proper closing of the door.

- The top part (1) of the door hinge can, after releasing the 2 screws (2) at the top or bottom of the door, be moved slightly in the direction of the arrow.
- The door can be adjusted after releasing the socket screw (3) and rotating the excentric (4) by means of a screwdriver. NOTE ! Screw (3) is locked with locking varnish. It can be released by a sharp tug using a hexagon socket key. Apply more locking varnish to screw (3) and tighten it.

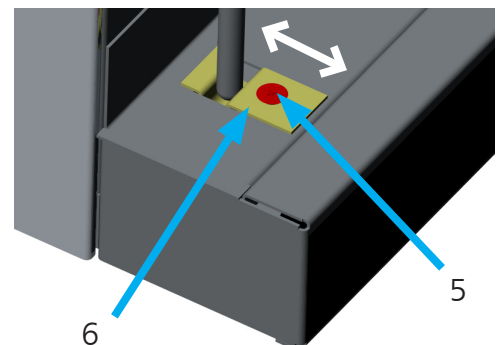
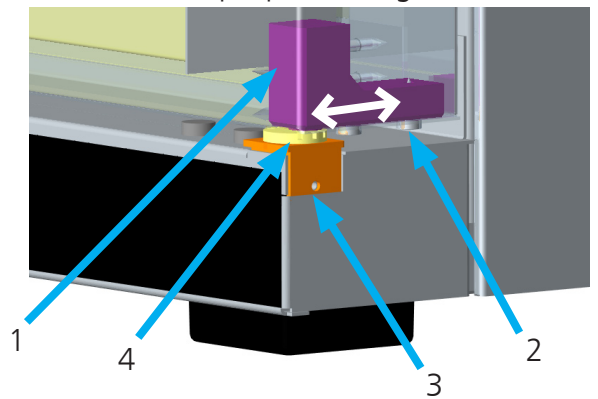

The closing panel (6) can also be adjusted in the direction of the arrow after releasing the screw (5). It is important that the panel is then screwed down firmly.

24 Error messages

E-0	Error on self test
E-1	Power module triac faulty
E-2	Power module faulty
E-3	PT100 temperature probe faulty
E-L1	Error communication to power unit L1
E-L2	Error communication to power unit L2
E-L3	Error communication to power unit L3
E-LA	Error communication to all power units (possibly controller faulty)

As far as PERFECT appliances are concerned, error messages are shown in the alphanumeric display. In case there is a fault on the oven, please get in touch with an authorised service organisation or contact the MEMMERT customer service department.

When dealing with the service department always quote the product serial number on the oven label.

25 Supply failure

Supply failure in operating mode "Normal operation"

After a supply failure the operation is continued with the set parameters. The instant and duration of the supply failure are documented in the record memory.

Supply failure in operating mode "Weekly programmer"

After a supply failure the operation is continued with the set parameters. The instant and duration of the supply failure are documented in the record memory.

Supply failure in programme operation

After a supply failure lasting less than 15 minutes the current programme is continued at the point where it was interrupted. The instant and duration of the supply failure are documented in the report memory.

On a supply failure lasting longer than 15 minutes the oven immediately starts in manual operation for safety reasons and all settings are set to safe default values (see table).

Supply failure in remote operation

On a supply failure in remote operation the oven immediately starts in manual operation for safety reasons and all settings are set to safe default values (see table). Programme continuation has to take place from the PC. The instant and duration of the supply failure are documented in the report memory.

Parameter	Default-value
Temperature	20 °C
Fan speed	maximum
Air valve	closed

EC Declaration of Conformity

Manufacturer's name and address: MEMMERT GmbH + Co. KG
Äußere Rittersbacher Straße 38
D-91126 Schwabach

Product: Universal oven
Type: UNB ... / UFB ... / UNE ... / UFE ... / UNP ... / UFP ...
Sizes: 100 / 200 / 300 / 400 / 500 / 550 / 600 / 700 / 800
Nominal voltage: AC 230 V or 3 ~ AC 400 V 50 / 60 Hz
alternative AC 115 V 50/60 Hz

The designated product is in conformity with the European EMC-Directive

2004/108/EEC

including amendments

Council Directive of 03 May 1989 on the approximation of the laws of the Member States relating to electromagnetic compatibility.

Full compliance with the standards listed below proves the conformity of the designated product with the essential protection requirements of the above-mentioned EC Directive:

DIN EN 61326:2004-05

EN 61326:1997
EN 61326/A1:1998
EN 61326/A2:2001
EN 61326/A2:2003

The designated product is in conformity with the European Low Voltage Directive

2006/95/EEC

including amendments

Council Directive on the approximation of the laws of the Member States relating to Electrical equipment for use within certain voltage limits.

Full compliance with the standards listed below proves the conformity of the designated product with the essential protection requirements of the above-mentioned EC Directive:

DIN EN 61 010-1 (VDE 0411 part 1):2002-08
DIN EN 61 010-2-010 (VDE 0411 part 2-010):2004-06

EN 61 010-1:2001
EN 61 010-2-010:2003

Schwabach, 03.07.08



(Legally binding signature of the issuer)

This declaration certifies compliance with the above mentioned directives but does not include a property assurance. The safety note given in the product documentation which are part of the supply, must be observed.

EC Declaration of Conformity

Manufacturer's name and address: MEMMERT GmbH + Co. KG
Äußere Rittersbacher Straße 38
D-91126 Schwabach

Product: Incubators
Type: INB ... /INE ... / INP ...
Sizes: 200 / 300 / 400 / 500 / 550 / 600 / 700 / 800
Nominal voltage: AC 230 V 50/60 Hz
alternative AC 115 V 50/60 Hz

The designated product is in conformity with the European EMC-Directive

2004/108/EEC
including amendments

Council Directive of 03 May 1989 on the approximation of the laws of the Member States relating to electromagnetic compatibility.

Full compliance with the standards listed below proves the conformity of the designated product with the essential protection requirements of the above-mentioned EC Directive:

DIN EN 61326:2004-05 EN 61326:1997
 EN 61326/A1:1998
 EN 61326/A2:2001
 EN 61326/A2:2003

The designated product is in conformity with the European Low Voltage Directive

2006/95/EEC
including amendments

Council Directive on the approximation of the laws of the Member States relating to Electrical equipment for use within certain voltage limits.

Full compliance with the standards listed below proves the conformity of the designated product with the essential protection requirements of the above-mentioned EC Directive:

DIN EN 61 010-1 (VDE 0411 part 1):2002-08 EN 61 010-1:2001
DIN EN 61 010-2-010 (VDE 0411 part 2-010):2004-06 EN 61 010-2-010:2003

Schwabach, 03.07.08



(Legally binding signature of the issuer)

This declaration certifies compliance with the above mentioned directives but does not include a property assurance. The safety note given in the product documentation which are part of the supply, must be observed.



|

■ EC Declaration of Conformity

Manufacturer's name and address: MEMMERT GmbH + Co. KG
Äußere Rittersbacher Straße 38
D-91126 Schwabach

Product: Sterilisers

Type: SNB ... / SFB ... / SNE ... / SFE ... / SFP ...

Sizes: 100 / 200 / 300 / 400 / 500 / 550 / 600 / 700 / 800

Nominal voltage: AC 230 V or 3 ~ AC 400 V 50 / 60 Hz
alternative AC 115 V 50/60 Hz

The product meets the regulations of the directive

93/42/EEC

Directive of the council to adapt legal regulations of the member states on the subject of medical products dd. 14.06.1993 (Abl. EG Nr. L 169, S. 1, 12.07.1993) including annex and modifications.

Schwabach, 25.02.08



(Legally binding signature of the issuer)

This declaration certifies compliance with the above mentioned directives but does not include a property assurance. The safety note given in the product documentation which are part of the supply, must be observed.

Standard ovens (UNP / UFP / INP) are safety-approved and bear the test marks:

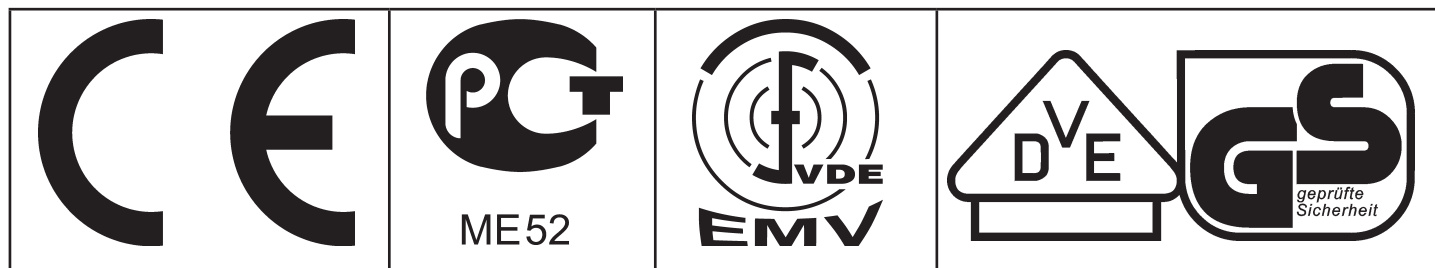

Sterilisers (SFP) are safety-approved and bear the test marks:



	<p>This product is subject to the Directive 2002/96/EC by the European Parliament and the EU Council of Ministers which concerns Waste Electrical and Electronic Equipment (WEEE). This product has been put on the market after 13 August 2005 in countries which have already incorporated this Directive into National Law. It should not be disposed off as part of domestic refuse. For disposal please contact your dealer or the manufacturer. Products which are infected, infectious or contaminated with health-endangering substances are excluded from return. Please note also all further regulations in this context.</p>
--	--

27 Address and customer service

MEMMERT GmbH+Co.KG
 PO Box 17 20
 91107 Schwabach
 Germany
 Phone: 00 49 9122 / 925-0
 Fax: 00 49 9122 / 14585
 E-mail: sales@memmert.com
 Internet: www.memmert.com

Customer service:
 Phone: 00 49 9122 / 925-143
 or 00 49 9122 / 925-126
 E-mail: service@memmert.com



When contacting customer service, always quote the product serial number on the oven label.

28 Index

A

accessories 9
address 53
air supply 10
air valve 13
air valve indication 11
alarm indication 11
alarm symbol 26, 28
ASF 29
automatic temperature monitor 29

B

BALANCE 36
basic oven settings 24
bus interface 35

C

calibration 32
calibration correction 32
calibration temperature 32
CE conformity declaration 50
cleaning 48
closure commands 19
connection 8
construction, oven 10
controls 11
customer service 53

D

day groups 15
delayed programme start 17
DIN 12 880 26
door 10
door handle 10

E

END 19
error messages 49

F

fan 10
fan indication 11
fan speed 13

H

heating power distribution 36
HOLD 19

I

indications 11
initial start-up 5
installation facilities 9
Interior lighting 12

L

light 12
load, oven 5
LOOP 19

M

maintenance 48
material quality 4, 7
medical product 4
memory card 38
MEMoryCard XL 38

N

NEXT 19
normal operation 13

O

OFF time 15
ON time 15
operating mode,
selection of 12
operating mode indication 11
operation 10
oven settings, basic 24
overtemperature
protection 27

P

parameters, setting the 12
printer 23
programme segments 19
Protection Class 1 26
Protection Class 2 28
Protection Class 3.1 28
protection devices 26
purpose, intended 4, 42

R

ramp segments 19
RS232C 34
RS485 35

S

setpoint-dependent
waiting time 17
SETPPOINT WAIT 19
SPWT(T) 19
stacking 9
start-up 5
STERICard 40
steriliser cassettes 47
sterilisers 42
subframe 9

T

TB 26
temperature, setting the 11
temperature calibration 32
temperature deviation 32
temperature display 11
temperature limiter 26
temperature monitor 26
temperature monitor,
automatic 29
temperature setpoint 11
time display 11
transport 4
TWB 28
TWW 28

U

undertemperature
protection 27
User-ID-Card 41

W

wall bracket 9
weekday 15
weekly programmer 15

20.08.2008

PERFECT englisch

D09805