

axxera™

CD Receiver



INSTALLATION/OWNER'S MANUAL

AXD130

MP3

WMA

COMPACT
disc
DIGITAL AUDIO

AUX
Front and Rear Inputs

USB

AXD130

Preparation

Please read entire manual before installation.

Before You Start

- Disconnect negative battery terminal. Consult a qualified technician for instructions.
- Avoid installing the unit where it would be subject to high temperatures, such as from direct sunlight, or where it would be subject to dust, dirt or excessive vibration.

Getting Started

- Remove trim ring from unit.
- Remove 2 transit screws located on top of the unit.
- Insert the supplied keys into the slots as shown, and slide the unit out of the mounting sleeve.
- Install mounting sleeve into opening, bending tabs to secure.
- Connect wiring harness and antenna. Consult a qualified technician if you are unsure.
- Certain vehicles may require an installation kit and/or wiring harness adapter (sold separately).
- Test for correct operation and slide into mounting sleeve to secure.
- Snap trim ring into place.

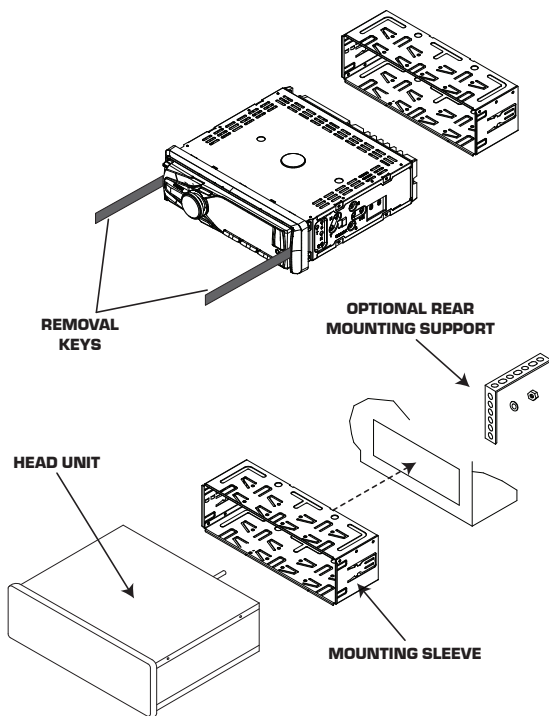

TYPICAL DIN FRONT-LOAD MOUNTING METHOD

AXD130

Wiring Diagram

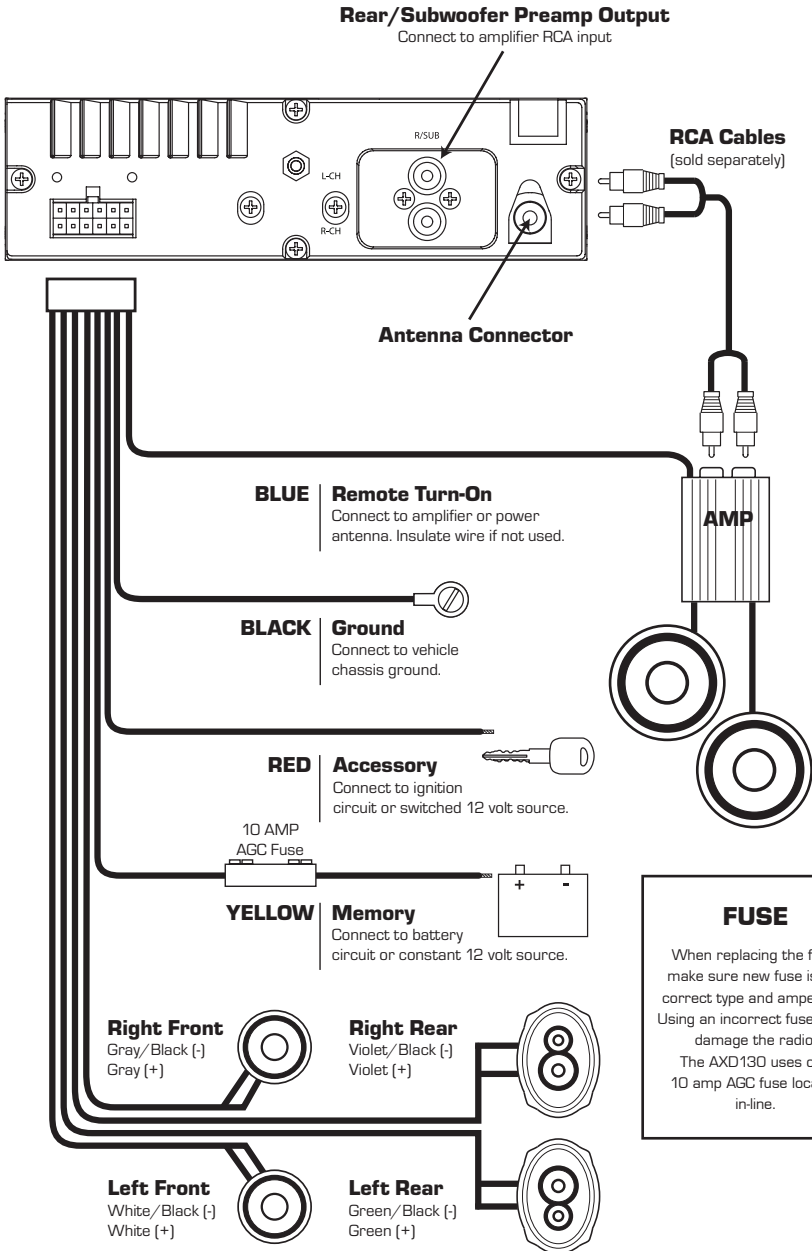

AXD130

Control Locations - Receiver

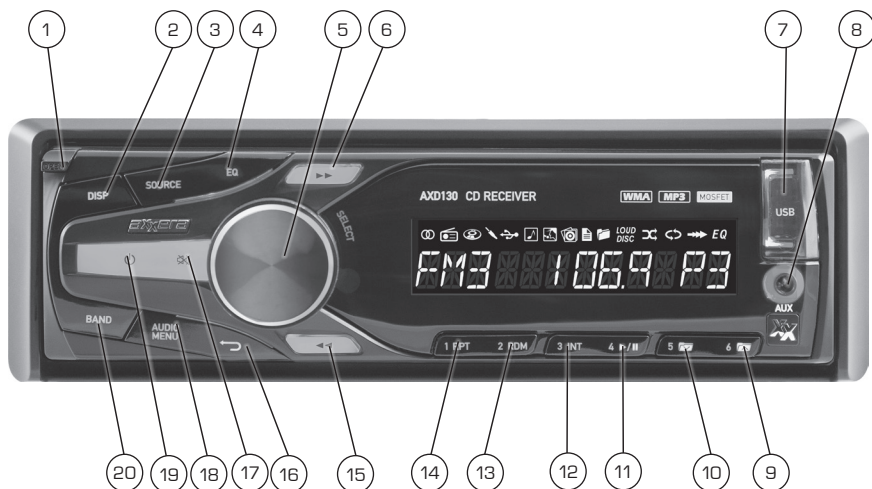

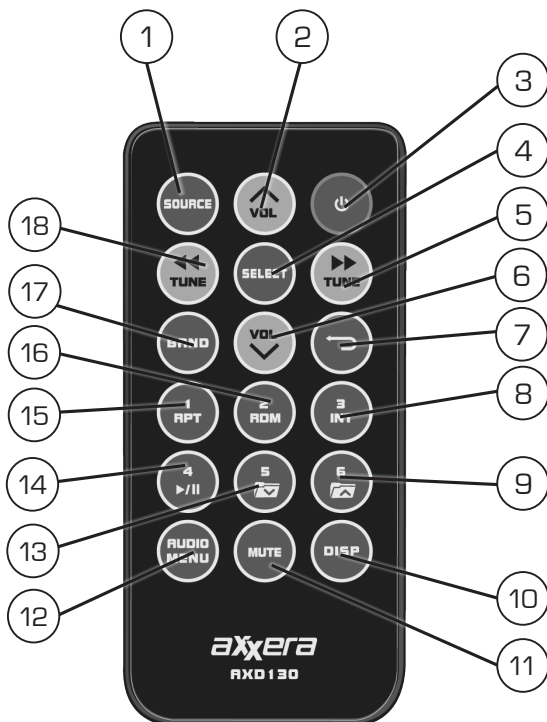

- | | |
|------------------------------|---------------------------|
| ① Open | ⑪ Preset 4 / Play / Pause |
| ② Display | ⑫ Preset 3 / Intro |
| ③ Source | ⑬ Preset 2 / Random |
| ④ Equalizer | ⑭ Preset 1 / Repeat |
| ⑤ Volume Knob/ Select (push) | ⑮ Tune / Track Down |
| ⑥ Tune / Track Up | ⑯ Go Back |
| ⑦ USB Port | ⑰ Mute |
| ⑧ Auxiliary Input | ⑱ Audio / Menu |
| ⑨ Preset 6 / Folder Up | ⑲ Power |
| ⑩ Preset 5 / Folder Down | ⑳ Band |

Control Locations - Remote



- | | |
|---------------------|------------------------|
| ① Source | ⑩ Display |
| ② Volume Up | ⑪ Mute |
| ③ Power | ⑫ Audio / Menu |
| ④ Select | ⑬ Key 5 / Folder Down |
| ⑤ Tune / Track Up | ⑭ Key 4 / Play / Pause |
| ⑥ Volume Down | ⑮ Key 1 / Repeat |
| ⑦ Go Back | ⑯ Key 2 / Random |
| ⑧ Key 3 / Intro | ⑰ Band |
| ⑨ Key 6 / Folder Up | ⑱ Tune / Track Down |

General Operation

Faceplate Removal	Press OPEN to open the face plate, then pull away from the right side to remove. To re-install, insert right side of faceplate first then push left side to secure.
Power On/Off	Press  or any other button to turn the unit on. Press  to turn the unit off.
Mode	Press SOURCE to select between AM/FM, CD player, auxiliary and USB modes. Modes of operation are shown in the display. NOTE: CD and USB modes will not appear unless a CD is inserted or USB device is connected.
Auxiliary Input	The AXD130 offers a 3.5 mm auxiliary input port on the front panel of the unit for connecting an audio device, MP3 player, etc. Press SOURCE to select auxiliary input mode.
Volume	Adjust volume using volume knob [00-46].
Display	Press DISP to select between clock and different types of information, such as radio frequency, CD track/elapsed time or MP3/WMA song information.
Reset	Press RESET upon initial installation or if abnormal operation occurs. Reset button is located behind the front panel.
Set the Clock	With the unit on, press and hold DISP until the clock begins to flash, then release. Press TUNE ►► to adjust the minutes and TUNE ◄◄ to adjust the hours.
12/24-hour Clock	The clock will display 12-hour AM/PM time in USA frequency spacing mode (PM 10:00). In European frequency spacing mode, the clock will display 24-hour time (22:00). Frequency spacing is adjusted in the setup menu (refer to page 7).
Setup Menu	Press and hold AUDIO/MENU for more than 3 seconds to access the setup menu. Press AUDIO/MENU momentarily to select between the menu functions and rotate the volume knob left/right to adjust or activate the desired function.

AXD130

General Operation - Setup Menu

Menu Function	Options	Action
Auto Station Store	AUTO STORE	Press SELECT to seek and save 6 strong stations in the current band. (Tuner mode only)
Local/Distance Tuning	LOCAL OFF	Activates distance tuning (Tuner mode only) .
	LOCAL ON	Activates local tuning for strong station reception only (Tuner mode only) .
Tuner Frequency Spacing	FREQ USA	Programs the unit to USA tuner spacing. (200kHz for FM and 10kHz for AM). (Tuner mode only)
	FREQ EURO	Programs the unit to European tuner spacing. (50kHz for FM and 9kHz for AM). (Tuner mode only)
Clock Display	CLOCK OFF	Programs unit to not display the clock when the power is off.
	CLOCK ON	Programs unit to display the clock when the power is off.
Subwoofer	R/SUB SUB	Programs the Rear/Sub RCA preamp output to subwoofer.
	R/SUB REAR	Programs the Rear/Sub RCA preamp output to rear.
Beep Confirmation	BEEP OFF	Disables the confirmation beep.
	BEEP ON	Enables the confirmation beep.
Programmable Turn On Volume	PRO-VOL #	Programs unit to always turn on at a specific volume (default is OFF). A volume level of 1-30 can be selected.
Power on Message	MESSAGE OFF	Disables power on message. (example: GOOD MORNING)
	MESSAGE ON	Enables power on message to be displayed.
Scrolling Option	SCROLL OFF	Programs unit to show the first 10 characters on the display.
	SCROLL ONCE	Programs unit to scroll once, then show the first 10 characters on display.
	SCROLL 15 S	Programs unit to scroll information once every 15 seconds (default).
	SCROLL ON	Programs unit to scroll continuously.
Demonstration Mode	DEMO OFF	Disables the demonstration mode.
	DEMO ON	Enables the demonstration message.

General Operation

Audio Press **AUDIO/MENU** momentarily to select between Bass, Middle, Treble, Balance, Fader, Loudness and Source Level.

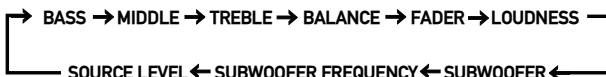

Bass Press **AUDIO/MENU** until **BASS** appears then rotate volume knob left/right to adjust (-6 minimum / +6 maximum).

Middle Press **AUDIO/MENU** until **MIDDLE** appears then rotate volume knob left/right to adjust (-6 minimum / +6 maximum).

Treble Press **AUDIO/MENU** until **TREBLE** appears then rotate volume knob left/right to adjust (-6 minimum / +6 maximum).

Balance Press **AUDIO/MENU** until **BALANCE** appears then rotate volume knob left/right to adjust (BAL 12L - BAL 12R). BALANCE EVEN represents equal balance.

Fader Press **AUDIO/MENU** until **FADER** appears then rotate volume knob left/right to adjust (FAD 12R - FAD 12F). FADER EVEN represents equal fader.

Loudness Press **AUDIO/MENU** until **LOUD** appears then rotate volume knob left/right to select LOUD ON or LOUD OFF.

* **Subwoofer** Press **AUDIO/MENU** until **SUBWFR** appears then rotate volume knob left/right to select a subwoofer level between 0 and 12.

* **Subwoofer Frequency** Press **AUDIO/MENU** until **SUBFREQ** appears then rotate volume knob left/right to select one of the following subfrequency levels: 80, 120, 160 or FLAT.

* **Note:** Subwoofer and Subfrequency audio adjustment only appears in the audio menu when the subwoofer option is set to "SUB" in the setup menu (refer to page 7 for details).

Source Level The source volume level control allows a gain adjustment for each audio source: AM, FM, CD, AUX and USB. Set the source volume level for each mode, depending on the relative volume of each audio source.

To set the source volume level, press **AUDIO/MENU** until **SRC LEVEL** appears. After one second, the current mode will appear on the display. Turn the volume knob to adjust the audio level of the current source (-6 minimum/+6 maximum).

Note: Only the current mode will be available for adjustment. To adjust another mode of operation, press **SOURCE** until the desired mode is selected, then set the source volume level for that mode.

AM/FM Tuner Operation

Manual Tuning

Press **TUNE** ◀◀ or **TUNE** ▶▶ momentarily to change radio frequency up or down one step at a time. Press and hold to advance quickly.

Seek Tuning

Press **TUNE** ◀◀ or **TUNE** ▶▶ for more than two seconds (then release) to automatically seek and tune to the next strong station.

Band

Press **BAND** to select between FM1, FM2, FM3, AM1 and AM2 bands.

Storing and Recalling Station Presets

Up to 18 FM stations and 12 AM stations can be stored. To store a station, select the desired band and station. Press and hold the desired preset button (1-6) for more than 2 seconds. When stored, the preset number will appear in the display. The station can be recalled anytime by pressing the corresponding preset button.

CD Operation

Insert CD Press **OPEN** to open the face plate and expose the CD slot. With the label facing up, insert a standard size CD into the CD slot. The CD will automatically begin playback.

Eject CD With the face plate open, press **EJECT** to eject the CD. The unit will change to previous mode of operation. If the disc is not removed within 10 seconds, the unit will reload the disc. The unit does not have to be turned on to eject CD.

Track Select Press **TRACK ►►** to skip to the beginning of the next track. Press **TRACK ◄◄** to return to the beginning of the current track. Pressing **TRACK ◄◄** again skips to the beginning of the previous track.

Fast Forward/Reverse Press and hold **TRACK ►►** or **TRACK ◄◄** on the remote control to fast forward or reverse a track.

Pause Press **►/||** to temporarily stop CD playback. Press **►/||** again to resume playback.

Repeat Press **RPT** to continuously repeats selected track. Press **RPT** again to turn the Repeat function off.

Random Press **RDM** to play all tracks in random order. Press **RDM** again to turn the Random function off.

Intro Press **INT** to play the first 10 seconds of each track. Press **INT** again to turn the Intro function off.

CD-R/CD-RW Compatibility Some CD-Rs and CD-RWs may be incompatible with this unit, depending on media type and recording method. In addition, the following CDs may be incompatible with this unit:

CDs exposed to extreme temperatures or direct sunlight for extended periods of time, CDs recorded in which a recording session failed or a re-recording was attempted and, or encrypted or copy-protected CDs which do not conform to the audio CD-DA red book recording standard.

CD Operation - MP3/WMA Files

Playing an MP3/WMA CD	<p>When an MP3/WMA encoded disc is first inserted, "READING" will flash in the display. Depending on the number of files and folders, this may take several seconds.</p>
Displaying Information	<p>Press DISP to step through available display options, including track number, elapsed time, track name, directory name, artist name and album name.</p> <p>*Song title, artist name and album name will only be displayed if included with the MP3/WMA file.</p> <p>When referring to MP3/WMA playback, the following terms are synonymous:</p> <ul style="list-style-type: none">• File name and track name• Folder name and directory name
Repeat	<p>Press RPT to enter the Repeat menu, then turn the volume knob to select one of the following options:</p> <ul style="list-style-type: none">• ALL - Plays all tracks on CD.• SONG - Continuously repeats selected song.• FOLDER - Continuously repeats all files in selected folder.
Random	<p>Press RDM to enter the Random menu, then turn the volume knob to select one of the following options:</p> <ul style="list-style-type: none">• OFF - Cancels the RDM function.• ALL - Plays all tracks in random order.• FOLDER - Plays all tracks in folder in random order.
Intro	<p>Press INT to enter the Intro menu, then turn the volume knob to select one of the following options:</p> <ul style="list-style-type: none">• OFF - Cancels the INT function.• ALL - Plays first 10 seconds of each track.• FOLDER - Plays first 10 seconds of each track in folder. <p>Note: Folder repeat, random and intro options only function on MP3/WMA discs recorded with more than one folder.</p>

CD Operation - MP3/WMA Files

File/Folder Compatibility and Support

Type	Specification
Compatible File Types	<ul style="list-style-type: none"> • CD-R, CD-RW • CD-DA (digital audio) • MP3 data [.mp3] • WMA data [.wma]
Incompatible File Types	<ul style="list-style-type: none"> • DRM protected files • WMA lossless • Apple lossless • WMA Pro • MP3 Pro • MP3 playlists • WAV lossless • M4A/AAC data
Recording Format Compatibility	<ul style="list-style-type: none"> • ISO9660 level 1 & level 2 • Yellow book MODE 1 & MODE 2 FORM 1 • Multi session
Sampling Frequency Rate Compatibility	<ul style="list-style-type: none"> • MP3: 8kHz - 48kHz • WMA: 8kHz - 48kHz
Transfer Bit Rate Compatibility	<ul style="list-style-type: none"> • MP3: 32kbps - 320kbps • WMA: 32kbps - 384kbps
Character Support	<ul style="list-style-type: none"> • Song Title: 32 characters • Artist Name: 32 characters • Album Name: 32 characters • File Name: 32 characters • Folder Name: 32 characters
ID3 Tag Support	<ul style="list-style-type: none"> • MP3 Tags: Version 1.0 - 2.4 • WMA Tags
File/Folder Limit	<ul style="list-style-type: none"> • Maximum files: 999 • Maximum folders: 255 • Maximum folder levels: 8

USB Operation

Connecting a USB Device (sold separately)

To play MP3/WMA files from most USB mass storage devices, line up the USB connector and insert the USB device into the AXD130's USB port.

Playing Music

When a USB device is first connected, "READING" will flash in the display, and playback will begin momentarily. Depending on the number of files and folders, it may take several seconds for the device to begin playing. If no valid MP3/WMA files are detected, "NO FILE" will be displayed and the last mode will be resumed.

Track Select

Press **TRACK** ►► to skip to the beginning of the next track. Press **TRACK** ◀◀ to return to the beginning of the current track. Pressing **TRACK** ◀◀ again skips to the beginning of the previous track.

Fast Forward and Reverse

Press and hold **TRACK** ►► or **TRACK** ◀◀ on the remote control to fast forward or reverse a track.

Pause

Press ►/|| to temporarily stop USB playback. Press ►/|| again to resume playback.

Displaying Information

ID3 tag and file/folder information will be automatically changed during playback. Press **DISP** to view the clock. Default display will resume after five seconds.

Repeat

Press **RPT** to enter the Repeat menu, then turn the volume knob to select one of the following options:

- ALL - Plays all tracks on CD.
- SONG - Continuously repeats selected song.
- FOLDER - Continuously repeats all files in selected folder.

Random

Press **RDM** to enter the Random menu, then turn the volume knob to select one of the following options:

- OFF - Cancels the RDM function.
- ALL - Plays all tracks in random order.
- FOLDER - Plays all tracks in folder in random order.

Intro

Press **INT** to enter the Intro menu, then turn the volume knob to select one of the following options:

- OFF - Cancels the INT function.
- ALL - Plays first 10 seconds of each track.
- FOLDER - Plays first 10 seconds of each track in folder.

Note: Folder repeat, random and intro options only function on USB devices recorded with more than one folder.

USB Operation

File/Folder Compatibility and Support

Type	Specification
Compatible File Types	<ul style="list-style-type: none"> • MP3 data (.mp3) • WMA data (.wma)
Incompatible File Types	<ul style="list-style-type: none"> • DRM protected files • WMA lossless • Apple lossless • WMA Pro • MP3 Pro • MP3 playlists • M4A/AAC data • WAV lossless
Sampling Frequency Rate Compatibility	<ul style="list-style-type: none"> • MP3: 8kHz - 48kHz • WMA: 8kHz - 48kHz
Transfer Bit Rate Compatibility	<ul style="list-style-type: none"> • MP3: 32kbps - 320kbps • WMA: 32kbps - 384kbps
Character Support	<ul style="list-style-type: none"> • Song Title: 32 characters • Artist Name: 32 characters • Album Name: 32 characters • File Name: 32 characters • Folder Name: 32 characters
ID3 Tag Support	<ul style="list-style-type: none"> • MP3 Tags: Version 1.0 - 2.4 • WMA Tags
File/Folder Limit	<ul style="list-style-type: none"> • Maximum number of files: 999 • Maximum number of folders: 255 (plus the root folder) • Maximum number of files in each folder: 999 <p>Note: For devices with more than the maximum number of files/folders, some files will be ignored and may not function properly.</p>
USB File System	<ul style="list-style-type: none"> • FAT/FAT32 file system supported. • HFS/NTFS/EXT2/EXT3 not supported.

Music Search - MP3/WMA Files

File/Folder Search

- Begin Searching** Press **SELECT** to enter the file/folder search mode. A list of all the folders from the disc or device will be displayed.
- Note:** Any files located in the root directory will be located in the folder named "ROOT".
- Choose a Song** Turn the **volume knob** to cycle through all the folders on the CD, and press **SELECT** to choose the desired folder. The list of files in the selected folder will be displayed. Turn the **volume knob** to cycle through the list of files.
- Menu Navigation** Pressing **GO BACK** when viewing the contents of a folder will return to the list of folders on the disc or device. Press **GO BACK** again to exit the search menu.
- Playing a Song** Once the desired song is displayed, press **SELECT** to begin playback of the desired song.

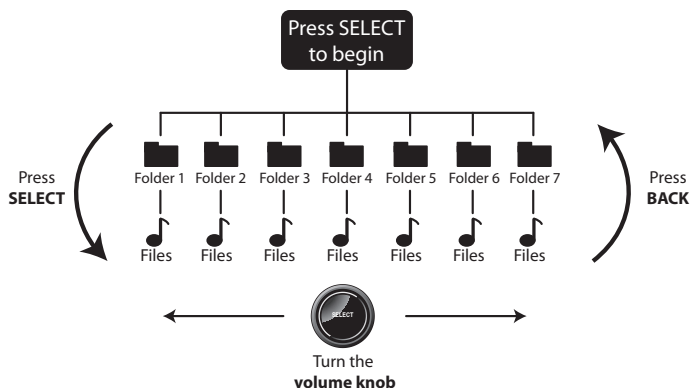

Limited One-Year Warranty

This warranty gives you specific legal rights. You may also have other rights which vary from state to state.

Dual Electronics Corp. warrants this product to the original purchaser to be free from defects in material and workmanship for a period of one year from the date of the original purchase.

Dual Electronics Corp. agrees, at our option, during the warranty period, to repair any defect in material or workmanship or to furnish an equal new, renewed or comparable product (whichever is deemed necessary) in exchange without charges, subject to verification of the defect or malfunction and proof of the date of purchase. Subsequent replacement products are warranted for the balance of the original warranty period.

Who is covered? This warranty is extended to the original retail purchaser for products purchased from an authorized Dual dealer and used in the U.S.A.

What is covered? This warranty covers all defects in material and workmanship in this product. The following are not covered: software, installation/removal costs, damage resulting from accident, misuse, abuse, neglect, product modification, improper installation, incorrect line voltage, unauthorized repair or failure to follow instructions supplied with the product, or damage occurring during return shipment of the product. Specific license conditions and copyright notices for the software can be found via www.dualav.com.

What to do?

1. Before you call for service, check the troubleshooting guide in your owner's manual. A slight adjustment of any custom controls may save you a service call.
2. If you require service during the warranty period, you must carefully pack the product (preferably in the original package) and ship it by prepaid transportation with a copy of the original receipt from the retailer to an authorized service center.
3. Please describe your problem in writing and include your name, a return UPS shipping address (P.O. Box not acceptable), and a daytime phone number with your shipment.
4. For more information and for the location of the nearest authorized service center please contact us by one of the following methods:

- Call us toll-free at 1-866-382-5476
- E-mail us at cs@dualav.com

Exclusion of Certain Damages: This warranty is exclusive and in lieu of any and all other warranties, expressed or implied, including without limitation the implied warranties of merchantability and fitness for a particular purpose and any obligation, liability, right, claim or remedy in contract or tort, whether or not arising from the company's negligence, actual or imputed. No person or representative is authorized to assume for the company any other liability in connection with the sale of this product. In no event shall the company be liable for indirect, incidental or consequential damages.

Troubleshooting

Problem	Cause	Action
Unit will not turn on (no power)	Yellow wire not connected or incorrect voltage Red wire not connected or incorrect voltage	Check connections for proper voltage (11-16VDC)
	Black wire not connected	Check connection to ground
	Fuse blown	Replace fuse
Unit has power (but no sound)	Speaker wires not connected	Check connections at speakers
	One or more speaker wires touching each other or touching chassis ground	Insulate all bare speaker wires from each other and chassis ground
Unit blows fuses	Yellow or red wire touching chassis ground	Check for pinched wire
	Speaker wires touching chassis ground	Check for pinched wire
	Incorrect fuse rating	Use fuse with correct rating
Excessive skipping	Unit is not mounted correctly or backstrap is not secure	Check mounting sleeve and backstrap support
	Physical defect in media (CD, CDR or CD-RW)	Check media for scratches
DISC ERROR appears on display	Disc read error	Press eject or RESET
	Focus error or disc is in upside down	Press eject or RESET
	The WMA file is copy-protected by DRM (Digital Rights Management)	Write disc using WMA files that are not copy-protected
NO FILE appears on display	No playable MP3/WMA files found on the device	Check the device for valid MP3/WMA files
Unit will not accept a disc	CD mechanism position out of alignment	Press EJECT to reset CD mechanism position
	CD transit screws still in place	Remove 2 transit screws located on top of the unit
NO SUPPORT appears on display	An invalid ID3 tag version is present	Version 1.0 to 2.0 ID3 tags are supported.

AXD130

Specifications

CD Player	Frequency response: 20Hz-20kHz Channel separation @ 1kHz: >45dB D/A converter: 1 Bit
FM Tuner	Tuning range: 87.5MHz-107.9MHz Usable sensitivity: 8.5dBf 50dB quieting sensitivity: 10dBf Stereo separation @ 1kHz: 30dB Frequency response: 30Hz-13kHz
AM Tuner	Tuning range: 530kHz-1710kHz Usable sensitivity: 22dBu Frequency response: 30Hz-2.2kHz
General	Speaker output impedance: 4-8 ohms Line output voltage: 2 Volts RMS Dimensions: 7" x 7" x 2" (178 x 178 x 50 mm)

Design and specifications subject to change without notice.



CEA-2006 Power Standard Specifications (reference: 14.4VDC +/- 0.2V, 20Hz~20kHz)

Power Output: 18 Watts RMS x 4 channels at 4 ohms and $\leq 1\%$ THD+N
Signal to Noise Ratio: 70dBa (reference: 1 watt into 4 ohms)

FCC Compliance

This device complies with Part 15 of the FCC Rules. Operation is subject to the following two conditions:

(1) this device may not cause harmful interference, and

(2) this device must accept any interference received, including interference that may cause undesired operation.

Warning: Changes or modifications to this unit not expressly approved by the party responsible for compliance could void the user's authority to operate the equipment.

Note: This equipment has been tested and found to comply with the limits for a Class B digital device, pursuant to Part 15 of the FCC Rules. These limits are designed to provide reasonable protection against harmful interference in a residential installation. This equipment generates, uses and can radiate radio frequency energy and, if not installed and used in accordance with the instructions, may cause harmful interference to radio communications. However, there is no guarantee that interference will not occur in a particular installation. If this equipment does cause harmful interference to radio or television reception, which can be determined by turning the equipment off and on, the user is encouraged to try to correct the interference by one or more of the following measures:

- Reorient or relocate the receiving antenna.
- Increase the separation between the equipment and receiver.
- Connect the equipment into an outlet on a circuit different from that to which the receiver is connected.
- Consult the dealer or an experienced radio/TV technician for help.

axxera[™]

Dual Electronics Corp.
Toll Free: 1-866-382-5476
Monday-Friday, 9AM-5PM, EST

www.axxeraaudio.com
©2013 Dual Electronics Corp. All rights reserved.

Other trademarks and trade names are those of their respective owners.

NSA0513-V01