



## User Manual

**Startup manual** gives you information of installation, preparation of the main unit and basic operation.



## INTRODUCTION

Thank you very much for purchasing the CAT EYE MSC-2Dx. The MSC-2Dx is a multi sports computer that combines the functions of a wireless heart rate monitor and a wired Cyclocomputer. Our race proven Cyclocomputer technology and the double pulse heartrate system enables you to monitor, track and record your training and racing like never before.

The recorded data can be downloaded to a PC by using the optional download unit.

Please read this manual to gain a thorough understanding of the product and how it works. Please keep this manual in a safe place.

If this manual is damaged or lost, contact our offices, your local dealer or [www.cateye.com](http://www.cateye.com).

### Important

- Always follow the warnings that are marked with  Warning!!!
- No part of this manual may be reproduced or transmitted without the prior written permission of Cat Eye Co., Ltd.
- The contents and illustrations in this manual are subject to change without notice.
- If there should be any errors or inaccuracies in this manual, please contact Cat Eye at [www.cateye.com](http://www.cateye.com).

# ABOUT THE MANUALS

---

## The following manuals are included:

### Quick Start manual

This manual gives you basic information on installation, set up and use of the main unit.

### User manual

This manual explains detailed use of the MSC-2Dx.

### Quick chart (Inside Carry Bag)

Reference chart.

The meaning of icons in this manual:



Warning!!!

Sections marked with these icons are critical for the safe use of the device. Instructions given must be followed.

---

### NOTE !

Helpful tips that cover important items are highlighted this way.

---

### CAUTION

Important cautionary notes on the use and operation of the MSC-2Dx.

---

Registration

Please register your MSC-2Dx to validate the warranty.



# CONTENTS

Introduction .....	1
Important .....	1
About the Manuals .....	2
The correct use of the Cat Eye MSC-2Dx .....	4
Name of Various Sections and Parts .....	5
Button Navigation .....	6
Changing the upper display .....	7
Functions .....	8
Using the Heart Rate Function	
Chest Belt Heart Rate Sensor .....	10
Before Wearing Chest Belt Heart Rate Sensor .....	10
Wearing The Heart Rate Sensor .....	11
Setting the Main Unit	
Setting Wheel Circumference .....	12
Setting Clock Time .....	13
Features	
Auto Time .....	14
Power Saving .....	14
Speed Pace .....	14
Lap .....	15
Heart Rate Target Zone .....	16
Memory Record .....	18
Downloading to a PC .....	23
Heart Rate Training .....	24
Trouble Shooting .....	26
Replacing Battery .....	28
Replacing Electrode Belt .....	29
Maintenance .....	29
Specifications .....	30
Registration .....	31
Accessories .....	32
Index .....	33



## Warning !!!

- Pace maker users should never use this device.
- This device should never be used in commercial aircraft.
- When using the MSC-2Dx, do not give excess attention to the monitor or the data. Pay attention to the road, traffic and your surroundings!
- Keep the device away from children. If children use this device, they should have adult supervision.
- Dispose of used batteries properly. Keep batteries out of the reach of children. In case the battery is swallowed by accident, consult a doctor immediately.

## NOTE !:

- The following places generate strong electromagnetic wave and interference, which cause incorrect measurement:
  1. Places near TV, PC, radios, motors/engines, or in cars and trains.
  2. Railroad crossings and near railway tracks, around television transmitting stations and radar bases.
- Do not use the chest belt if it causes a rash or other skin irritations.
- Avoid dropping or severely jarring the main unit or chest strap.
- When the chest belt becomes soiled with sweat, clean it with mild soap and water.
- Do not bend, twist or pull forcibly the electrode area of the chest belt.
- Try to avoid using the main unit within a 1.5m radius of other transmitters. Do not use other wireless devices simultaneously. It may result in improper measurements.
- Avoid exposing the main unit to direct sun light for extended periods of time when not in use.
- Do not disassemble the main unit. We recommend taking the main unit to a professional jeweler for battery replacement and proper resealing.
- Periodically check the positions and mounting condition of the magnet and the speed sensor.
- Never apply chemicals (thinner or benzene) to the unit.
- Static electricity could cause a function error, resulting in abnormal display of the data. In such a case, reset the main unit.

# NAME OF VARIOUS SECTIONS AND PARTS

## Main Unit

### A. Display

1. Upper Display
2. Middle Display
3. Lower Display
4. Speed Icon
5. Clock Time Icon
6. Speed Scale Icon
7. Heart Rate Target Zone Icon
8. Auto Time Mode Icon
9. Heart Rate Icon
10. Used Memory Rate Icon
11. Wheel Circumferences Icon
12. Alarm Icon
13. Memory Record Icon
14. Heart Rate Scale
15. Speed Pace Arrow
16. Selected Functions Icon

### B. Lap Button (LAP)

### C. Set Button (SET/AT)

### D. Light Button (LT)

### E. Mode Button (MODE)

### F. Start/Stop Button (S/S)

### G. All Clear Button (AC)

### H. Wrist Band

### I. Back Cover

### J. Contacts

### K. Serial No.

## Chest Belt Heart Rate Sensor

### L. Transmitter

### M. Electrode Belt

### N. Attachment Belt

## Mounting parts

### O. Bracket

### P. 2Dx Attachment

### Q. Speed Sensor

### R. Wheel Magnet

### S. Rubber Pad

### T. Nylon Tie

### U. Sensor Screw

### V. Sensor Band B

### W. Sensor Band A (Large)(Small)

## Accessories

### Carry Bag

### Quick Chart

### Quick Start Manual

### User Manual

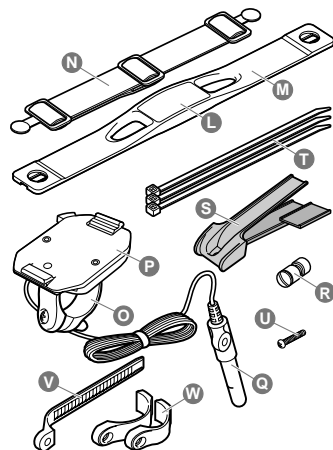
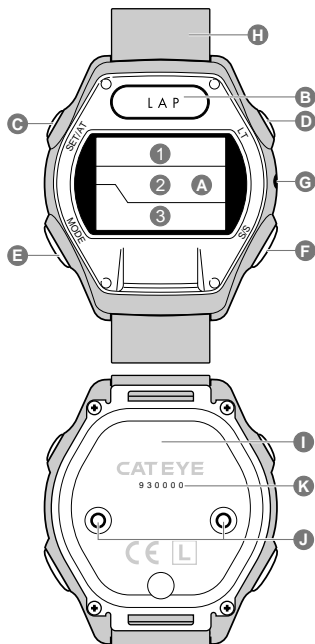
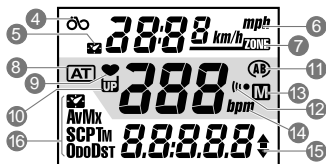

# BUTTON NAVIGATION

## Mode Button (MODE)

Under standard operations, this button switches the function of the lower display.

The functions of the lower display are divided into the main functions. Each main function has a corresponding sub function. To switch the functions of the lower display:

- Push MODE button to switch from one main function to the next main function.
- Hold down MODE button for more than 2 seconds to switch from a main function to its sub function.
- Push MODE button again to return to the main function from the sub function.
- You cannot directly move from one sub function to another.

See the following diagram for the flow of the main and sub functions.

**NOTE !:** This screen display can be switched from Clock Time to Speed on the lower screen.

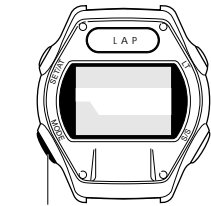

Mode Button (MODE)

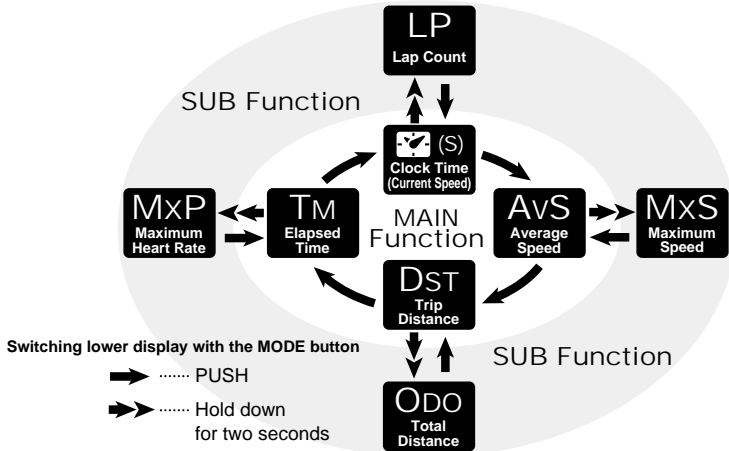

Lap Button (LAP) Light Button (LT)

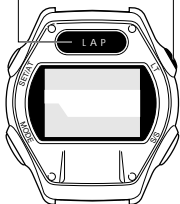

## Lap Button (LAP)

When the unit is measuring time, heart rate, etc., push this button to record data (Elapsed Time, Distance, Lap's Average Speed and Lap's Average Heart Rate) at any arbitrary point. Up to 50 lap data points can be captured. (See page 15, "Lap Feature")

## Light Button (LT)

This button illuminates the screen for about 3 seconds.

Set Button (SET/AT)

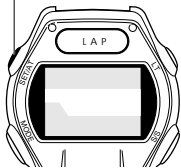

## Set Button (SET/AT)

This button is used to enter various setting screens. See the right diagram for how the screen changes.

When you are setting data into the unit, this button is used to fix and complete the setting.

Data on Lower Display	(SET/AT)	Area to Enter, Setting Item
Elapsed Time	<b>Tm</b>	Auto Time Feature On/Off
Average Speed	<b>AvS</b>	
Trip Distance	<b>Dst</b>	
Maximum Speed	<b>MxS</b>	Confirming Heart Rate Target Zone
Clock Time	<b>CL</b>	Clock Time Setting
Lap Count	<b>LP</b>	Lap Data Readout
Maximum H.R.	<b>MxP</b>	Memory Record File Select
Total Distance	<b>Odo</b>	Wheel Circumference Setting

## Start/Stop Button (S/S)

This button starts/stops measurement of Elapsed Time, Average Speed and Distance. While measuring, "bpm" in the middle display flashes. When Auto Time feature (**AT**) is on, this button does not function.

### Changing the Upper Display

#### Upper Display Select



- When Auto Time feature is off (**AT** is off), push SET/AT button and S/S button at the same time and the upper display changes from Current Speed to Clock.



- When Auto Time feature is on (**AT** is on), this button switches between speed and clock.

Start/Stop Button (S/S)

## All Clear Button (AC)

**NOTE!** This button is not used for normal daily operations. Push this button after replacing the battery or after a display error occurs.

This button deletes the lap data, record memory data and the clock time setting. The total distance, wheel circumference, speed scale and heart rate target zone settings will not be deleted.

After pushing AC button, reset the clock time.

- If the AC button is pressed while holding SET/AT button, the MSC-2Dx returns to the default state and all data is erased. Some users might want to perform this function at the beginning of a training season to record yearly training mileage in the Odometer. Do not perform this ALL CLEAR under normal condition.

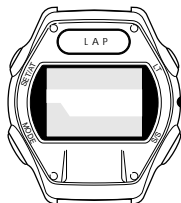

AC Button (AC)

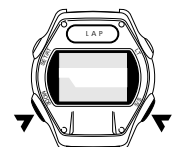

Reset Operation

## Reset Operation

If MODE button and S/S button are pressed simultaneously, elapsed time, maximum heart rate, average speed, maximum speed, and trip distance will be reset to zero and the lap data will be erased, provided that the lower display is not in Odometer mode.

# FUNCTIONS

## Upper Display

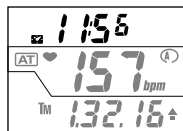
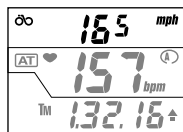

Either Current Speed or Clock Time can be selected on the upper display. (See page 7)

### Current Speed

The speed icon flashes. The data is updated once a second.  
Range: 0.0 (3.0) ~ 65.9 mph [0.0 (4.0) ~ 105.9 km/h]

### Clock Time

The clock icon flashes. Time is displayed in 24 hour or 12 hour.

#### Reference:

When the speed scale is "km/h", the clock time is always displayed in a 24-hour clock. When the "mph", the clock time is always displayed in a 12-hour clock.

## Middle Display

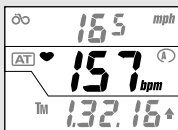

### Heart Rate

When the chest belt heart rate sensor is attached to the body, the heart rate icon flashes and the Heart Rate is displayed in real time.

Display Range: 0~299 bpm

## Lower Display

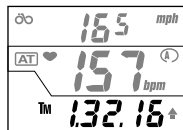

Select the desired function with MODE button on the lower display. Refer to page 6, "Mode Button" for navigation to each function.

### Tm Elapsed Time (Timer)

The time lapse from the start to the present time is shown in hours, minutes and seconds. The elapsed time data returns to zero with the reset option.

Range: 0.00.00~9.59.59

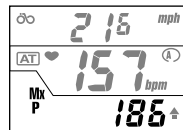

### MxP Maximum Heart Rate

The maximum heart rate from the start to the present time is displayed. This is the sub function of Elapsed Time. The Max Heart Rate data returns to zero when the MSC is reset.

Range: 0 ~ 299 bpm

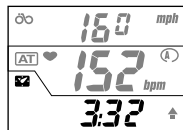

### Clock Time

Current time is displayed in 24 hour or 12 hour time. The Clock can be moved to the upper display. (Current Speed would then appear in the lower display.) (See page 7)



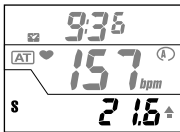

### S Current Speed

The present speed is displayed. It is updated once a second.  
 Range: 0.0(3.0)~65.9 mph [0.0(4.0)~105.9 km/h]

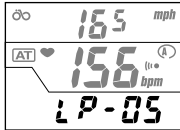

### LP Lap Count

The lap count from the start to the present time is displayed. This is the sub function of Clock Time (or Current Speed). The Lap data returns to zero when the MSC is reset.  
 Range: LP-00 ~ LP-50

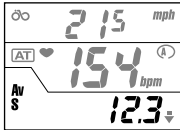

### AvS Average Speed

The average speed from the start to the present time is displayed. The Average Speed data returns to zero when the MSC is reset. When the elapsed time exceeds 27:46'39", or the trip distance exceeds 999.99 mile[km], (E) will appear on the display and calculation of average speed ceases indicating an Error.  
 Range: 0.0~65.9 mph [0.0~105.9 km/h]

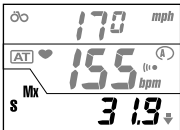

### MxS Maximum Speed

The maximum instantaneous speed is displayed. This is the sub function of Average Speed. The Max Speed data returns to zero when the MSC is reset.  
 Range: 0.0 (3.0) ~ 65.9 mph [0.0 (4.0) ~ 105.9 km/h]

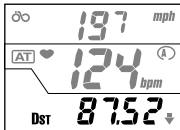

### Dst Trip Distance

The trip distance from the start to the present time is displayed. The distance data returns to zero when the MSC is reset.  
 Range: 0.00~999.99 mile [km]

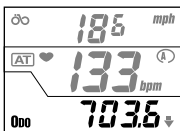

### Odo Total Distance

The trip distance is accumulated continuously. This is the sub function of Trip Distance. From 0 to 9,999.9, the increment is 0.1; from 10,000 to 99,999, the increment is 1.  
 Range: 0.0 ~ 9,999.9/10,000 ~ 99,999 mile [km]



### PTm Time in Pulse Zone (Time in Training Zone) **Readout Screen**

In the readout screen, the time spent within the heart rate target zone is displayed. The upper and middle displays indicate the upper and the lower limit of the zone respectively, and the lower display indicates the time spent in that heart rate zone.

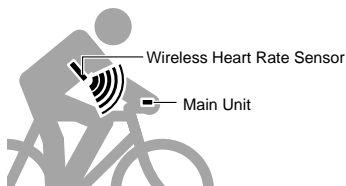

### Chest Belt Heart Rate Sensor

The chest belt heart rate sensor is based on the electrocardiograph methodology used in hospitals. The MSC-2Dx uses this technology but in a simplified and miniaturized form. In this methodology, electrodes attached to the body sense the differences of electric potential and thus heart rate is measured. In the same manner, MSC-2Dx's chest belt sensor uses two built-in electrodes that come into contact with the body to detect differences in electric potential. The signal is then transmitted to the main unit and heart rate is displayed.

**Reference:**

Maximum transmitting distance: **about 90 cm.**

### Before Wearing Chest Belt Heart Rate Sensor

 **Warning !!!**

**Pace maker users should never use this device.**

**NOTE !:**

- Wear the chest belt heart rate sensor at the center of your chest and in contact with your skin.
- To increase measurement effectiveness, dampen the electrode area with water or electrocardiograph electrolyte cream.
- People with sensitive skin can wear the chest belt over a thin shirt with the electrode area damped with water.
- Hair on the chest may interfere with accurate measurements.
- Do not use this unit with other cordless devices (including CATEYE CC-CL200) or some lamps (including CATEYE Stadium Light). Interference might occur, resulting in incorrect measurement.

## Wearing the Heart Rate Sensor

### NOTE !:

When wearing the chest belt heart rate sensor, ensure that the top mark on the transmitter comes to the top. If worn upside down, signal's transmittable distance might become shorter.

1. Adjust the length of the belt to fit your chest.
2. Hook the attachment belt to the electrode belt. Place the electrode area at the center of your chest. Be sure that the electrode area is held firmly against your skin.

**Reference:** When wearing the chest belt heart rate sensor over a shirt it is necessary to moisten the electrode area for the better results. In the winter season when skin can be dried, errors may occur even when the electrodes are in direct contact with your skin. This can be improved by moistening the electrodes.

3. Adjust the belt so that the transmitter is at the center (just above your diaphragm) of your chest.

Wear the chest belt heart rate sensor in the legible way (the top mark on the transmitter should come to the top).

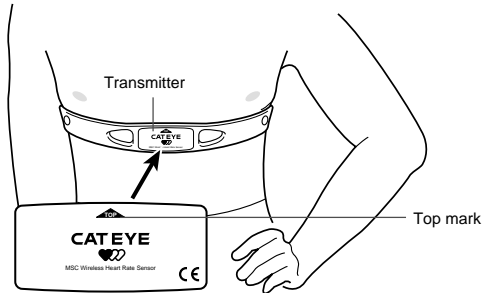
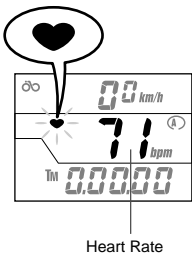

4. Place the main unit in front of your body. Check if the heart rate icon ♥ flashes in the middle display and the heart rate appears.

If the heart rate icon ♥ is not flashing, check the position of the chest belt heart rate sensor, moisten the electrode area, move away from any outside electronic interference, and try again.

# SETTING THE MAIN UNIT

## Setting Wheel Circumference

You can input two kinds of wheel circumferences into MSC-2Dx, so it can be quickly switched between two bikes.

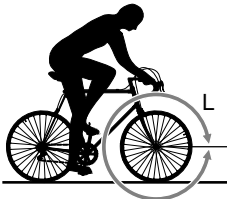

### 1. Determine the wheel circumference.

Refer to the Tire Size Reference Table below to determine your tire's circumference. For the most accurate setting you can perform a "wheel roll-out". To do this pump your tires up to normal pressure. On a level area place the valve stem perpendicular to the ground and mark the spot. Get on the bike and with your weight bearing on the tires roll one complete wheel length forward. Mark where the valve stem is perpendicular to the ground again. Measure the distance between the two. This number in millimeters is the most accurate calibration number you can put into the computer.

**Reference:** The tire size is shown on the side of your tire.

### 2. Push AC button.

The screen will illuminate for one second and then "km/h" or "mph" will flash. Push MODE button to switch between "km/h" and "mph".

### 3. Push SET/AT button.

The speed scale is now set. The wheel circumference set up screen now appears. The wheel circumference icon (A) and the preset wheel circumference (2096) flash.

### 4. Change the value.

- Push MODE button to increase the number.
  - Push LAP button to decrease the number.
- Hold down the button for rapid advancement.

#### Reference:

You can easily change a value for another wheel circumference (B) at this stage.

Push MODE and LT buttons simultaneously to switch to (B) and change the value by the same procedure described in 4.

### 5. Push SET/AT button.

The wheel circumference setting is completed. Elapsed Time TM function appears.

#### Setting Values Cross Reference Table

Tire Size	L(mm)
24 x 1	1753
24 x 3/4 Tubular	1785
24 x 1-1/8 Tubular	1795
24 x 1-1/4	1905
24 x 1.75	1890
24 x 2.00	1925
24 x 2.125	1965
26 x 1(559mm)	1913
26 x 1(650C)	1952
26 x 1.25	1953
26 x 1-1/8 Tubular	1970
26 x 1-3/8	2068
26 x 1-1/2	2100
26 x 1.40	2005
26 x 1.50	1985
26 x 1.75	2023
26 x 1.95	2050
<b>26 x 2.00</b>	<b>2055</b>
26 x 2.1	2068
26 x 2.125	2070
26 x 2.35	2083
27 x 1	2145
27 x 1-1/8	2155
27 x 1-1/4	2161
27 x 1-3/8	2169
650 x 35A	2090
650 x 38A	2125
650 x 38B	2105
700 x 18C	2070
700 x 19C	2090
700 x 20C	2086
<b>700 x 23C</b>	<b>2096</b>
700 x 25C	2105
700 x 28C	2136
700 x 30C	2170
700 x 32C	2155
700C Tubular	2130
700 x 35C	2168
700 x 38C	2180
700 x 44C	2224

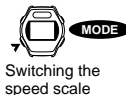
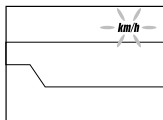

Switching the speed scale



The wheel circumference setting screen

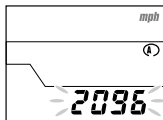

Increase the number



Decrease the number



Completes the wheel circumference setting

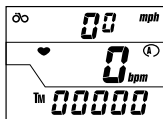

## NOTE !: Wheel Circumference A and B.

Wheel circumference (A) is specifically programmed for road riding and wheel circumference (B) is programmed for low speed sensitivity. If you are using this unit on a mountain bike, we recommend using the (B) calibration number for riding.

The initial setting of the wheel circumference is as follows:

Wheel Circumference (A) ----- 2096 (27 inch Standard Tire: 700 x 23C)

Wheel Circumference (B) ----- 2050 (MTB 26 x 1.95 Tire)

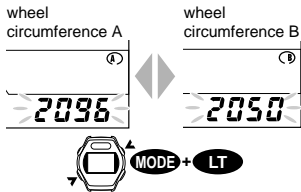

## Switching Between Wheel Circumference A and B

Elapsed time **TM** must not be running to switch settings.

Navigate to the Total Distance **ODO** on the lower display and push SET/AT button to enter the wheel circumference setting screen.

Push MODE and LT buttons simultaneously to switch between (A) and (B) wheel settings.

## Checking Wheel Circumference

You can check the current wheel circumference in the **ODO** mode by pressing the MODE and S/S buttons simultaneously.

## Changing Wheel Circumferences

To change the wheel circumference navigate to Total Distance **ODO**. (The Elapsed time **TM** can not be running.) Perform steps 3 through 5.

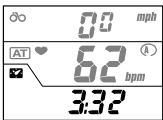

Clock time setting screen

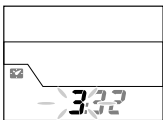

Increase the number



Decrease the number



Time unit switching

Completes the clock time setting

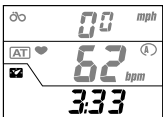

## Setting Clock Time

1. The Elapsed time **TM** must be turned off. The "bpm" icon of the middle display can not be flashing.
2. Navigate to the Clock Time  in the lower display
3. Push SET/AT button. The display enters the clock time set up screen and the hour flashes.
4. Press MODE button to increase and LAP button to decrease the number. Hold down the button for rapid advancement.
5. Push S/S button. The minutes flash.
6. Press MODE button to increase the digits and LAP button to decrease. Hold down the button for rapid advancement.
7. Push SET/AT button. Clock time is now set.

## NOTE !:

The digits for second becomes zero (:00) when SET/AT button is pressed.

# FEATURES

## Auto Time Feature (Auto Start/Stop)

When the Auto Time feature of AT is on, the main unit automatically starts/stops measuring and recording when ever the wheel is rotating. **[AT]** icon appears on the middle display. When AT feature is on, buttons will not start or stop any operations. Therefore the AT feature is only useful when using the unit for cycling.

When you use this unit on your wrist, turn off the Auto Time (**[AT]**) feature.

**NOTE !: If you turn **[AT]** feature on while using the unit as a wristwatch/heart rate monitor, the unit stops measuring. Be careful not to press the SET/AT button during wristwatch/heart rate use.**

### Switching Auto Time feature On/Off

1. The Auto Time feature can be turned on or off when Elapsed Time **TM**, Average Speed **AVS** or Trip Distance **DST** is in the lower display.
2. Push SET/AT button to turn on or off the Auto Time feature.

Auto Time feature is turned on when the **[AT]** icon appears or off when the **[AT]** icon is not visible.

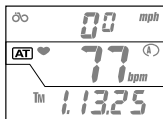

Auto time feature On

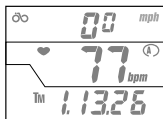

Auto time feature Off

## Power Saving Feature

When the main unit is left without any button operation or without receiving any signal of heart rate or wheel signal for about 15 minutes continuously, the power supply is shut down and the unit will go into the Sleep State, displaying only the clock (as in the left figure).

However, even in the Sleep State, the unit continues to count Elapsed Time **TM**.

When any button other than LT button is pressed, or the current signal is received, the screen wakes up and returns to normal display.

**NOTE !: If the unit is left with the readout screen or the setup screen of target heart rate zone/Lap/Memory Record, the power saving feature might not work. Always leave your MSC in a main function for long records of time.**

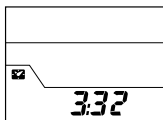

The Pace Arrow

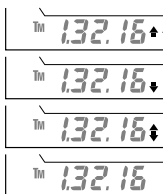

## Speed Pace Feature

The Pace arrow on the lower display indicates the current speed level, whether it is higher or lower than the average speed.

▲ ----- The current speed is higher than the average speed.

▼ ----- The current speed is lower than the average speed.

⬆ ----- The current speed is equal to the average speed.

No illumination ----- The current speed and/or average speed is zero.

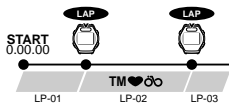

Lap interval longer than 5 sec.  
Up to about 27 hrs.

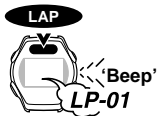

Lap number display for 3 sec.

## Lap Feature

Up to 50 lap data points can be captured (Elapsed Time, Average Heart Rate for the lap, [Average Speed for the lap] and Trip Distance) and stored in memory for manual review or downloading to a PC with an interface unit.

### Recording Lap Data

In any of the main or sub functions, push the LAP button. The beep sound goes off and the lap data is saved. At the same time, the lower display indicates the current lap number for about 3 seconds.

**NOTE !:** You must wait a minimum 5 seconds before recording next lap. The maximum measurable time is 27 hours and 46 minutes.

Because the lap data captured is the average heart rate and average speed for the interval, short lap intervals may produce inconsistent data.

**NOTE !:** Lap data can be recorded even if Elapsed Time TM is not running (=stop state). However, once you record the lap data in the Stop State, next lap data cannot be recorded unless current speed gets started. The reset operation erases all lap data points.

### Lap Data Read Out

To review the lap data:



Elapsed Time is not running. (=stop state)

1. Navigate to where the Lap Count LP is in the lower display.
2. Push SET/AT button.

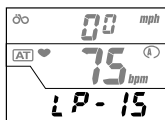

Switching TM/DST

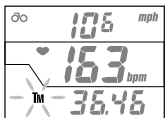

Lap data readout screen

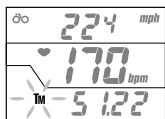

The next lap data

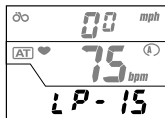

The lap number is shown in the lower display for 1 second, and the screen starts to readout the lap data.

The upper display indicates Average Speed, the middle display indicates Average Heart Rate and the lower display indicates Elapsed Time with the flashing TM icon. To switch the lower display between Elapsed time TM and Trip distance DST, hold down the MODE button.

**NOTE !:** The data of heart rate and speed shown here is the average value of the interval between the two points.

If you hold down LAP button for 2 seconds, the unit starts to download the data and the readout screen is fast-forwarded automatically. The screen continues fast-forwarding until the download is finished.

3. Continue the readout.  
Push LAP button to move to the next lap data.  
Push MODE button to return to the prior lap data.

**NOTE !:** Each lap number appears in the lower display for 1 second.

**NOTE !:** If you hold down LAP button, the unit starts downloading. If you have started to download by mistake, it can be stopped by pressing the Lap button again.

4. When you have finished reviewing the Lap data, push SET/AT button and the screen returns to the Lap Count LP display.

### Downloading Lap Data

The recorded lap data can be downloaded to a PC through the optional interface unit and e-train data software. See the download manual for details.

# Heart Rate Target Zone

The unit records the time you stayed in your targeted heart rate zones. This data can be manually reviewed or downloaded later to a PC.

Four target heart rate zones can be set. (Zone.1~Zone.4). The audible alarm tells you when your heart rate is outside of the specified zone.

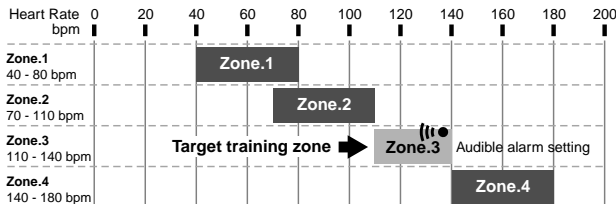

The chart shows an example of how zone 3 (target heart rate 110-140) is set with the audible alarm. The alarm will not sound when you are within the target zone of 110-140 bpm.

**NOTE !: Heart rate target zones are completely independent of each other.**

**They can overlap or do not have to touch another zone.**

**NOTE !: Alarm will not sound till you have first entered the zone.**

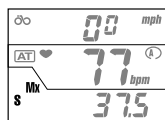

MXS display



**H.R. target zones  
readout screen**

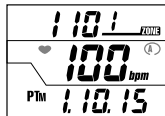

Upper heart rate limit

Lower heart rate limit

Time in heart rate zone



**H.R. target zones  
setting screen**



Upper heart rate limit

Lower heart rate limit

Zone number



**MODE**

Increase the number



**LAP**

Decrease the number



To upper heart rate limit setting

Zone 2 ~ Zone 4 setting in same way



**SET/AT**



## Setting Heart Rate Target Zones

Set each zone using the following procedure.

1. Navigate the lower display to Maximum Speed **MXS**.
2. Push SET/AT button.

The unit enters the readout screen of target zone.

3. Push SET/AT button again.

The unit enters the target zone set up screen.

The lower limit of zone 1 flashes in the middle display.

4. Set the desired lower heart rate limit.

- Push MODE button to increase the value.
- Push LAP button to decrease the value.

5. Push SET/AT button, and the lower heart rate limit is set. Then the upper heart rate limit flashes in the upper display.

Push S/S button to set (or reset) the alarm sound for this zone. (See page 17, "Setting Heart Rate Alarm Sound".)

6. Set the desired upper heart rate limit.

7. Push SET/AT button to set zone 1.

The screen enters zone 2 set up screen.

8. Repeat steps 4 - 7 for all zones.

9. After completing zone 4, push SET/AT button.

Target zone setting is completed. The screen returns to the maximum speed **MXS** function.

**NOTE !: Once you enter the H.R. target zone set up screen, you must navigate all the way from zone 1-zone 4. There is no short cut out of this set up.**



Alarm is off.

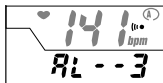

Alarm is set.

## Setting Alarm Sound

The alarm sound goes off when your heart rate is outside the range. If the alarm is set, the alarm icon (♥⚡) appears in the middle display. You can set the alarm in every zone.

To set the alarm, push S/S button in the desired zone's set up screen. To turn off the alarm, push S/S button again.

\* Once the alarm is set, the icon in the lower display changes from "Zone." to "AL--" so that you can see in which zone the alarm is set.

**NOTE !: The alarm goes off when your heart rate is out of the zone.**

**Alarm does not sound in the Stop State when Elapsed Time TM is not on.**

## Time In Heart Rate Zone

You can review how long you stayed in each target heart rate zone.

1. Navigate to Maximum Speed **MXS** in the lower display.

2. Push SET/AT button.

The unit enters the readout screen for target zone. The time in each zone is shown on the lower display.

You can download the data by mounting the unit on the interface unit and press the LAP button for 2 seconds.

3. Push MODE button to switch between the zones.

4. Push MODE button in zone 4, and the screen returns to Maximum Speed **MXS** function.

**NOTE !: You can check the time in zones even while still measuring. Hold down MODE button a little longer to switch between the zones. In the readout screen, bpm icon flashes to indicate that the measurement is proceeding, but ♥ icon does not flash.**

## Resetting Time In Heart Rate Zone

To delete the data of time in training zone, hold MODE and S/S buttons simultaneously in the readout screen of target zone. All data in the four training zones will be deleted.

**NOTE !: The ordinary reset operation done to reset distance, time, average speed etc. does not clear the data for time in training zones. You must not set this from within this function.**

## Downloading Time In Training Zone

The data of time in training zones can be downloaded to a PC through the optional interface unit. See the download manual for instructions.

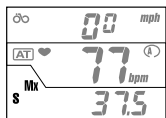

MXS display



H.R. target zone readout screen



Upper heart rate limit

Lower heart rate limit

Time in heart rate zone

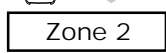

Downloading



Saved data reset

## Memory Record Interval Feature

Memory Record saves elapsed time, heart rate, speed and trip distance at the specified time interval in a selected file. You can choose from 4 time intervals (5, 15, 30 and 60 seconds) and record them to 5 separate files.

- When the Memory Record is on, **M** icon appears in the middle display.
- Memory Record data can only be erased from the individual file it was recorded to.
- The data is downloadable to a PC through the optional interface unit.

The total memory capacity is 2560 points. Used memory of each file is shown as a percentage of the total available.

**NOTE !:** Memory Record capacity and Lap feature's memory capacity are independent.

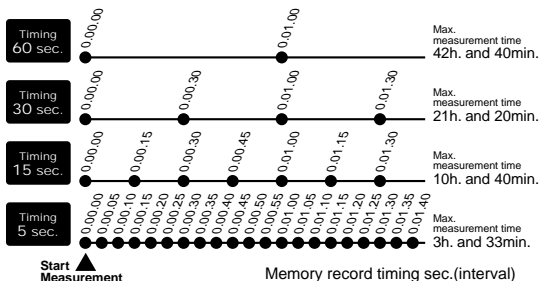
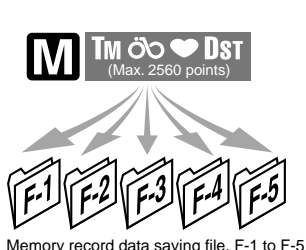

### Procedure for Memory Record

Take the following steps to record data to memory.

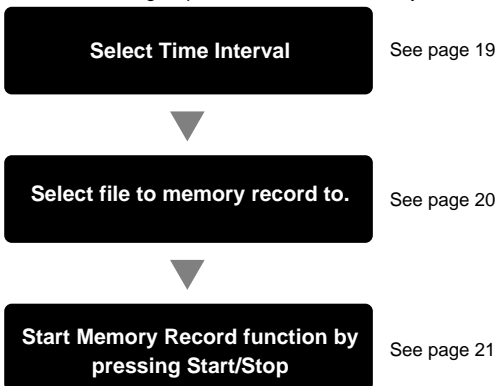

### Main/Sub Function



#### Memory record timing selection screen

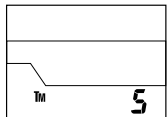

Timing selection  
→5 sec.→15 sec.  
→30 sec.→60 sec.



Complete the memory record timing select setting.



## Memory Record Interval Selection

Start from any function.



**M** icon must be off.

Hold down the Start/Stop Button for 2 seconds if Elapsed Time **TM** is running or turn **TM** on and then hold down for 2 seconds to turn **TM** off and turn Memory Record off.

1. Push MODE and SET/AT buttons simultaneously in any of the main or sub functions.  
Memory Record Interval is shown in the lower display.
2. Press the MODE button to advance the Memory Record Interval from 5, 15, 30 or 60.
3. Push SET/AT button at the desired Memory Record Interval.  
The Memory Record Interval is complete and the screen returns to Elapsed Time **TM** function.

## Check the Memory Record Files

Check the amount of memory stored in each file.

Check the memory files with the following procedures.



**M** icon must be turned off.



"Elapsed Time **TM**" can not be running. (Timer is in the Stop-state)

When **M** icon is on, turn it off according to the instruction in page 21.

1. Navigate the lower display to show Maximum Heart Rate **MPX**.
2. Push SET/AT button to enter the memory record file screen. The upper display shows the file number.

Middle display shows the percentage of the total memory each file is using. The lower display shows the remaining measurable time under the current Memory Record Interval.

**NOTE !:**  
**Depending on the Memory Record Interval you select, remaining time will vary.**

3. You can navigate through each file by pressing the LAP button. Note the file number on the top line of the screen. Check each file's used memory and delete any files to free up memory. Delete files by pressing and holding the Start/Stop and Mode buttons for two seconds. See that the center number (percentage of total memory used) goes to zero and additional time appears on the lower display.
4. Push SET/AT button to return to Maximum Heart Rate **MPX**.

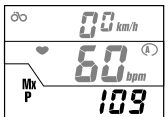

MXP display



#### Memory record file screen

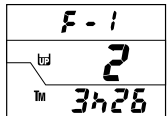

File Number

Used Memory Rate (%)

Max. measurable time  
Ex.) 3h and 26min.



File number switching

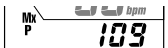

Complete of confirmation

## Setting up Memory Record

**M OFF** **M** icon must be turned off.

**TM STOP** "Elapsed Time **TM**" can not be running. (Timer is in the Stop-state)

**TM 0.00.00** "Elapsed Time **TM**" must be zero. (Reset **TM** by pressing the Start/Stop and Mode buttons simultaneously.)

When **M** icon is on, turn it off according to the instructions on page 21.

1. Navigate the lower screen to show Maximum Heart Rate **MXP** (a sub function of Elapsed Time **TM**).
2. Push SET/AT button to enter the memory record file screen.
3. Push LAP button and select a file from "F-1 to F-5" to record your activity into.
4. To delete the data already stored in the file, push S/S and MODE button simultaneously.

(Data deletion is done individually in each file.)

**NOTE !:** You cannot add additional data to a file that already has data recorded in it.

5. Push S/S button.

The file is selected and **M** icon appears.

**NOTE !:** If **M** icon does not appear, Elapsed time **TM** may not be zero. Go back to the top of this page, reset the unit and follow the procedure again.

6. Push SET/AT button.

The lower display returns to the Maximum Heart Rate **MXP**. Preparation is completed and the unit is ready to start memory record .

**NOTE !:**

- Be sure to check the remaining time before starting to record to memory. If the recordable memory time is not long enough, increase it by deleting some data stored in other files or selecting a different Memory Record Interval.
- When the used memory exceeds the capacity, the memory feature automatically turns off.

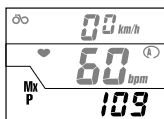

MXP display

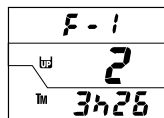

Memory record file screen



File selection



Erase memory data

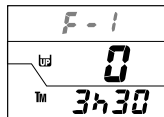

File number

Used Memory Rate (%)

Max. Measurable time



Select auto memory in file 1

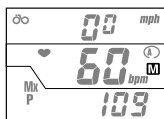
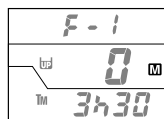

Memory record measurement ready

## Memory Record On/Off

### Starting Memory Record

Check that the **M** icon is on in the middle display (memory record feature is in stand-by state). Push S/S button and data of heart rate, speed, etc., is recording to memory. If the Auto Time feature is on (**AT** icon is on), the memory record measurement automatically starts when the bicycle starts.

**NOTE !: You can use lap feature only with the memory record reviewing.**

### Turning off Memory Record

To turn off memory record of the activity, holding down the S/S button for more than 2 seconds. **M** icon disappears.

**NOTE !: When the Auto Time feature is on (**AT** icon is on), Memory Record does not turn off even when your bicycle stops. You must manually turn it off by holding down S/S button for more than 2 seconds.**

- You can also turn off the memory record features by resetting the computer. But in this case, note that the general data is erased but the memory record data is stored in the file you selected.

### NOTE !:

Memory Record does not turn off unless you manually turn it off. See if Memory Record is on or off by noting if the **M** icon is visible. Only when the memory exceeds its capacity Memory Record is automatically turned off.

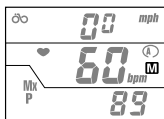

Memory Record  
Feature is stand-by



S/S

Memory Record  
Measurement

Memorizing of data  
measured at  
selected interval  
(timing)



S/S

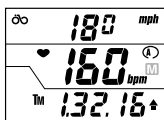

Complete of  
memory record  
measurement

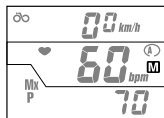

S/S



MODE+

S/S

Memory Record Measurement is  
released and **M** mark disappears.

### Canceling Memory Record

#### (Turning off **M** icon before timing starts)

To turn off Memory Record when the MSC-2Dx is in a stand-by state (**M** icon is on but the Elapsed Time **TM** has not started):

Hold down S/S button for more than 2 seconds, or

Reset the unit.

The **M** icon disappears and Memory Record is cancelled.

## Memory Record Data Review

Use the following procedure to review the data saved during Memory Record.

**NOTE !:** You cannot review the data while you are still recording to memory.



**M** icon must be off.



"Elapsed Time **TM**" must not be running (Stop-state)

If **M** icon is on, turn it off. In any mode or sub-mode press the Start/Stop button for two seconds.

1. Navigate so the lower display is Maximum Heart Rate **MXP**.
2. Push SET button to enter the Memory Record file screen.
3. Push LAP button to select the file to review.
4. Push MODE button to enter the file.

**M** icon appears and the screen starts replaying the recorded data from memory. **TM** icon flashes. By holding down MODE button, the lower display changes from Elapsed Time **TM** to Trip Distance **DST**.

5. Push LAP (or MODE) button to advance to the next data point. This time interval is determined by the Record Interval you selected (5, 15, 30 or 60 seconds).

**NOTE !:** If you hold down LAP button for 2 seconds, the unit starts downloading the data and the screen is fast forwarded automatically. The unit continues fast forwarding until the download is complete. If you have started downloading by mistake, stop it by pushing LAP button.

6. Push SET/AT button to return to the memory record file screen.
7. Push SET/AT button again, and the screen returns to Maximum Heart Rate **MXP**.

## Download Memory Record Data

Ride data of heart rate, speed, time and distance can be downloaded into a PC. See the download manual for details.

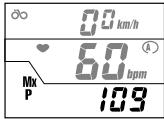

MXP display

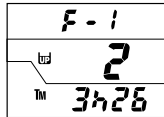

Memory record file screen



File selection



Memory record readout screen

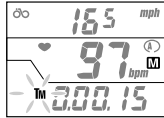

Switching TM/DST

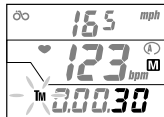

Next point data

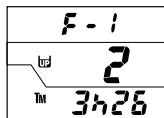

Memory record file screen



MXP display

## Downloading to a PC

By using the optional download unit, the data of memory record, lap and heart rate target zone can be downloaded to PC.

### Memory Record

Heart rate, speed, elapsed time and distance at every point is downloaded in CSV (Comma Separated Value) format, and displayed in the graph format on the screen.

### Lap

Heart rate, speed, elapsed time and distance at every lap is downloaded in CSV format.

### Heart rate target zone

Zone number, target zone and time in pulse zone is downloaded in CSV format.

## How to download

Set the main unit on the interface unit and hold down the LAP button in each function's readout screen. The unit starts to download the data and the readout screen is fast-forwarded.

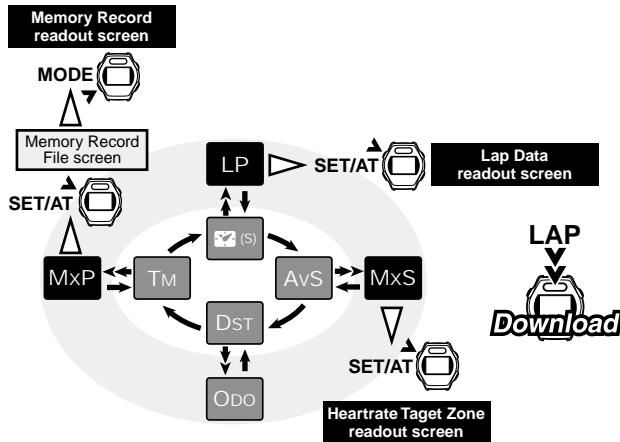

# HEART RATE TRAINING

The following is very general information about heart rate training. There are many good books on the subject. Visit a local bookseller or visit our web site for more in depth heart rate training information.

In general, heart rate goes up while exercising. The harder you exercise, the faster your heart will beat. In this way, heart rate is a good indication of the exercise intensity. By setting your target heart rate and making an effort to maintain that rate, you will be able to work out more efficiently. Before starting a training program, consult a medical specialist or trainer.

## 1. For improving your general fitness

Bicycling is one of the best activities to improve your general fitness. To improve your overall fitness through bicycling, set your target heart rate zone from the training level of between 30% and 70%, depending on your physical strength. It is desirable to work for twenty to thirty minutes a time, at a frequency of more than three times a week. To obtain your target zone, see the table below, which illustrates the correlation between heart rate and training level. For beginners, it is recommended to start with the level of 30%. From this point, gradually increase the level according to your fitness level and experience. For a purpose of improving your health, 70% is considered to be the highest goal.

For the purpose of losing weight, work at a comparatively lower level for a longer period. For maximum benefit you will want to workout for more than one hour at a time.

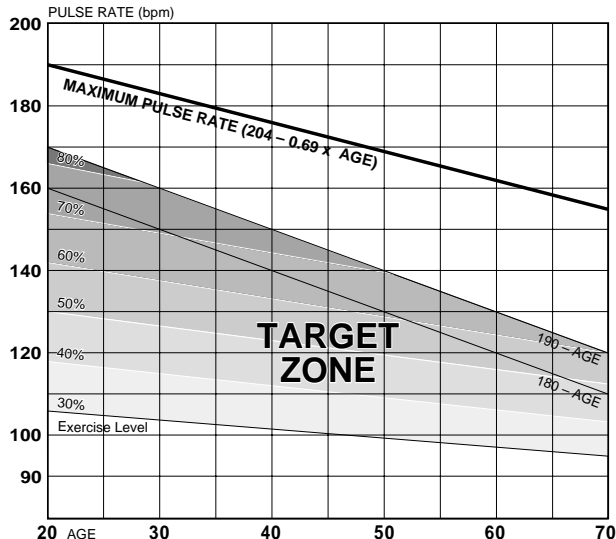



## 2. For competitors

Measure your resting heart rate just after awakening in the morning and your maximum heart rate (perhaps during competition). Then set your target zone according to your goal:

### A) For longer physical-endurance

Aiming at races which last for many hours  
or over consecutive days:  
60% - 70% (aerobic exercise)



### B) For physical-endurance which lasts about two hours

70% - 80% (aerobic exercise)



### C) For pushing power at full force for about a minute

more than 85% (anaerobic exercise)



### D) For instantaneous maximum power which lasts for several seconds (sprinting)

more than 95% (anaerobic exercise)



$$\text{Training level (\%)} = \frac{(\text{Target heart rate}) - (\text{Resting heart rate})}{(\text{Maximum heart rate}) - (\text{Resting heart rate})} \times 100$$

$$\text{Target heart rate} = (\text{Maximum heart rate} - \text{Resting heart rate})$$

$$\times \frac{\text{Training level (\%)} + \text{Resting heart rate}}{100}$$

### Resting heart rate

Measure your resting heart rate when you are awake in bed in the morning.

### Maximum heart rate

The following calculations are generally used:  $(220 - \text{age})$  or  $(240 - 0.69 \times \text{age})$ .

For more precise figure, consult a training specialist.

## TROUBLE SHOOTING

If a malfunction occurs, check the following before contacting Cat Eye or your retailer for repair or service.

Check if there is any electronic device around that might interfere with the measurement.

Trouble	Check Items	Remedy
<b>The liquid crystal screen appears dark or there are some dark spots.</b>	Was it left for a long time under direct sunlight?	It will return to normal after a few hours once it is out of the sunlight. Data will not be effected.
<b>Display response is slow.</b>	Was the ambient temperature too low (below 32°F [0°C])?	It will return to normal when the temperature rises. Data will not be effected.
<b>No display appears.</b>	Is the battery in the main unit worn out? Replace it with a new one (CR2032).	<b>NOTE !: After the battery is replaced, the AC (All Clear) button must be pressed to reset the data and set up the MSC-2Dx.</b>
<b>Meaningless display appears.</b>	Push AC button, and reset the unit again following the instruction in page 12, "SETTING THE MAIN UNIT", or refer to the Quick Start manual.	
<b>Heart rate measurement is abnormal.</b>	Are you near any electronic devices that are emitting electromagnetic signals (such as TV, stereo, motor or personal computer). While measuring heart rate, try to keep a greater distance away from these devices. Reset the data.	
<b>Current speed is no working properly.</b>	Check if there is any object on the contacts of the main unit or the bracket. Clean the contacts. Main unit is often stained with sweat. Periodically wash it with a mild hand soap and wipe dry. Check the clearance between the speed sensor and the magnet. Check if the marking line of the speed sensor and the magnet is aligned. Adjust the positions of the speed sensor and the magnet. (See Quick Start manual.) Check if the cable of the speed sensor is broken or damaged. Replace the bracket sensor set with a new one.	
<b>The timer does not stop even though S/S button is pressed (S/S button does not work).</b>	Is the Auto Time feature on ( <b>AT</b> icon is on)? When the Auto Time feature is on, S/S button does not start or stop measurement. Turn the Auto Time feature off if desired. (Refer to page 14, "Auto Time Feature".)	
<b>Heart rate display is not stable and the value is lower than the actual.</b>	Has the battery in the heart rate sensor is worn out? Replace the battery (CR2032).	

---

**The unit does not receive the heart rate signal.**

Check if the unit is in the sleep state (power saving feature is on).

Push any button other than the AC button.

Is the heart rate sensor placed in the correct position?

Adjust the position according to the instruction.

Is the heart rate sensor attached securely to your body?

Attach the sensor so that the electrode area contacts closely with your skin.

Is your skin dry (especially in winter)?

Lightly moisturize the electrode area.

Has the battery in the heart rate sensor worn out?

Replace it with a new one (CR2032).

Has the battery in the main unit worn out?

Replace it with a new one (CR2032).

Have the electrodes belts deteriorated over normal use?

Replace them with new ones. (See your local dealer or [www.cateye.com](http://www.cateye.com).)

---

**The heart rate display occasionally reads zero.**

Is the heart rate sensor in correct position?

Adjust the position according to the instruction.

The heart rate reads zero where there is some interference from an outside signal or the transmitter is too far from the main unit. Move closer to the main unit or move away from the radio frequency interference.

The battery in the main unit has worn out. Replace it with a new one.

---

**The display does not show Memory Record file.**

Is **M** icon on? Is the elapsed time TM measuring?

The display does not show the Memory Record file when the memory record feature is on or elapsed time is running. (See page 19, "Check Memory Record Files")

---

**You cannot turn record memory feature on. (**M** icon does not appear.)**

Reset Elapsed Time **TM**. (See page 20, "Setting up Memory Record")

---

**You cannot change the Interval Timer of memory record.**

Is **M** icon on?

If memory record feature is on, you cannot change Interval Timer. (See page 19, "Memory Record Interval Selection")

---

**The unit cannot record LAP data.**

At least 5 seconds of interval is needed to record the next lap data.

---

**The unit cannot read out LAP data.**

Is the elapsed time measuring?

The unit cannot read out LAP data when the elapsed time is measuring. (See page 15, "Lap Data Read Out")

---

**Clock setting screen does not appear.**

The display does not show clock setting screen when the elapsed time is running. (See page 13, "Setting Clock Time")

---

# REPLACING BATTERY

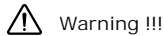

Warning !!!

**Safely dispose of the old battery. Do not place them within children's reach. If a battery is swallowed by accident, consult a doctor immediately.**

When the factory loaded battery has worn out, replace it with a new one according to the following instruction:

**NOTE !:** Always replace both batteries at the same time (the one in the main unit and the one in the chest belt).

## Main Unit

Battery life: **approx. 2 years** (if used for 1 hour a day)

The battery life shown in this manual is not definitive and it varies depending on the use environment.

### Caution:

When replacing the battery in the main unit it is highly recommended that you have this operation done by a professional jeweler who can test the unit for watertightness after re-sealing it.

- Back cover seal is critical to maintain the water resistant capacity. When re-assembling after replacing the battery, check if the packing properly fits in position.
- When replacing battery, handle the unit carefully and do not apply much pressure on any part of the unit.

1. Remove four screws on the back cover of the main unit using a precision screwdriver No.0.
2. Slide the battery lock to the direction of the arrow in the figure.
3. Replace it with a new lithium battery (CR2032) with (+) pole facing upward. Fasten the battery with the battery lock.
4. Replace the back cover and tighten the screws using a precision screwdriver No.0.

After replacing the battery, you **MUST** press AC button and set the clock time again.

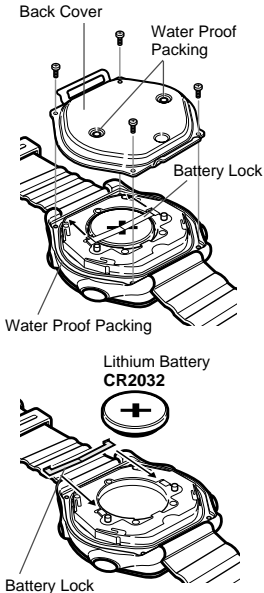

## Wireless Heart Rate Sensor

Battery life: **approx. 2 years** (if worn for 1 hour a day)

### Caution:

- The Wireless Heart Rate Sensor continues to consume battery while being attached to your body. When you are not measuring heart rate, remove it from your chest to save the battery life.
- Battery cover seal is critical for maintaining its watertight capacity. Check the battery cover for proper fit and positioning closing.

1. Remove the battery cover on the back of the transmitter with a coin.
2. Replace the old battery with a new lithium battery (CR2032) with the (+) pole upward as illustrated.
3. Close the battery cover securely.

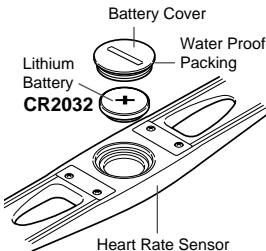

## REPLACING ELECTRODE BELT

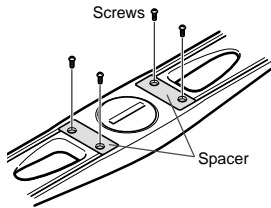

The electrodes on the chest belt naturally wear out after extended use. (See your retailer of [www.cateye.com](http://www.cateye.com) to obtain a replacement.) When there are cracks on the surface or measurement error occurs, replace the electrode belt with new one according to the following instruction:

1. Loosen the screws at the back of the transmitter.

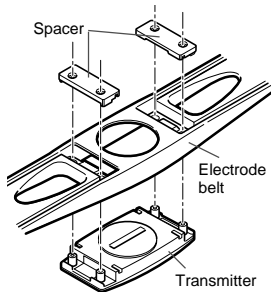

2. Remove the spacers. Remove the transmitter from the electrode belt.

3. Fix the transmitter to a new electrode belt. Clean the two contacts before assembling.

**NOTE !: If the contacts are dirty, the electrodes may fail to detect heart rate.**

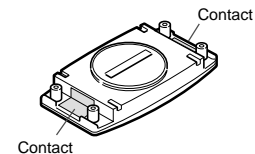

4. Put the spacers back and fasten the screws securely.













**NOTE !: When replacing the electrode belt, also check the transmitter's battery life.**

## MAINTENANCE

### Daily Care of the MSC-2Dx:

- The contacts on the main unit may be stained by sweat or oils. Wash the contact periodically with mild soapy water.
- If the contacts on the bracket get wet, wipe them dry following the ride. If they get rusty, or if they begin to corrode, it may result in the speed detection error.
- When the main unit or the chest belt heart rate sensor is soiled, wash it with water or clean it with mild soapy water using a soft cloth, and wipe it dry. Do not use benzene, alcohol or other solvent. They will damage the surface and void the warranty.
- Attachment belt absorbs sweat. To keep it clean, wash it occasionally with mild soapy water.
- Periodically check the position of the speed sensor and the magnet to assure they are properly aligned.

# SPECIFICATIONS

Display functions (Icon)		Range	Standard accuracy
Upper display	Current speed	<i>km/h mph</i> 0.0(3.0) - 65.9mph [0.0(4.0) - 105.9km/h]	±0.5mph (under 31mph)
	Clock time	1:00 - 12:59 [0:00 - 23:59]	±0.003%
	Speed icon	 Illuminates when Current Speed is selected.	
	Clock time icon	 Illuminates when Clock Time is selected.	
Center display	Heart rate	<i>bpm</i> 0 - 299 bpm	±1bpm
	Heart rate icon	 Blinks when the heart rate signal is received.	
	Record memory icon	 Illuminates when the record memory feature is activated.	
	Auto icon	 Illuminates when the Auto Time (automatic start/stop) feature is activated.	
	Alarm icon	 Illuminates when the alarm for heart rate target zone is operated.	
	Used memory icon	 Illuminates when using record memory rate (%) is indicated on display.	
	Wheel circumference icon	 Displays the wheel circumference currently active.	
Lower display	Elapsed time	 0:00'00" - 9:59'59"	±0.003%
	Maximum heart rate	<i>MxP</i> 0 - 299bpm	±1bpm
	Clock time	 1:00 - 12:59 [0:00 - 23:59]	±0.003%
	Current speed	<i>S</i> 0.0(3.0) - 65.9mph [0.0(4.0) - 105.9km/h]	±0.5mph (under 31mph)
	Lap count	<i>L P</i> LP-00 - LP-50 (Lap Feature)	
	Average speed	<i>AvS</i> 0.0 - 65.9mph [0.0 - 105.9km/h]	±0.5mph
	Maximum speed	<i>MxS</i> 0.0(3.0) - 65.9mph [0.0(4.0) - 105.9km/h]	±0.5mph (under 31mph)
	Trip distance	<i>Dst</i> 0.00 - 999.99mile [km]	±0.01mile (under 31mph)
	Total distance	 0.0 - 9999.9 / 10000 - 99999mile [km]	±0.1/1mile (under 31mph)
	Zone remaining time	<i>PTM</i> 0:00'00" - 9:59'59"	±1"
	Pace icon	 Displays whether the speed is higher or lower than the average speed. (Pace Feature)	
Additional features	Heart rate target zone	Heart rate range is divided into 4 zones and Time In Pulse Zone is measured and saved (Alarm may be set in each zone).	
	Memory Record feature	Saves measurement data for 5 files or maximum 2,560 points (Memory Record Interval timing may be selected from 5, 15, 30 or 60 sec.).	
	Lap feature	Saves for a maximum 50 points (Minimum interval: 5 sec.).	
	Others	Power saving feature (Auto reset upon receipt of speed sensor signal or forced reset by button operation). Download saved data to a PC (Optional download kit is required). <sup>*1</sup>	
Control system:	4-bit one-chip microcomputer, crystal oscillator		
Display system:	Liquid crystal display (equipped with the LED backlight)		
Speed signal detection system:	Noncontact magnetic sensor		
Heart rate signal transfer system:	Wireless signal simultaneous transfer (Transmission distance: Approx. 90 cm)		
Operating temperature range:	32°F - 104°F [0°C - 40°C] (Can be used below 0° with slower screen response.)		
Storage temperature range:	-4°F - 122°F [-20°C - 50°C]		
Wheel circumference set range:	10 - 3000mm / A/B switching method, initial value: A-2096, B-2050		
Applicable fork diameter:	11Ø - 36Ø		
Power supply/battery life:	Pre-installed batteries are for primarily for factory testing purpose. Their life may be shorter than replacement batteries. Normal battery life as follows:		
	Main unit:	CR2032 x 1 / approx. 2 years (When using 1 hour/day)	
	Heart rate sensor:	CR2032 x 1 / approx. 2 years (When attaching to body 1 hour/day)	
Dimensions/Weight:	Main unit:	1-13/16" x 2-1/16" x 19/32" [46.0 x 52.5 x 14.4 mm] / 1.52 oz. [43 grams]	
	Heart rate sensor:	13" x 1-7/16" x 19/32" [330 x 36 x 15 mm] / 2.19 oz [62 grams]	

Designs and specifications are subject to change without notice, due to modifications or improvements.

\*1) Windows 95/98 or Windows 2000 required; RS232C (serial port) needed

## REGISTRATION

CAT EYE Web Site (<http://www.cateye.com>)

For warranty service you must register your product. Please register your MSC-2Dx as soon as possible. CAT EYE provides you technical support and new product information as much as possible.

Please register on-line through our web site, or send the registration card below directly to our Customer Service Department. For registration, please fill in the product's serial number (the 6-digits number marked on the back of the main unit).

--	--	--	--	--	--



**CAT EYE CO., LTD.**

2-8-25 Kuwazu Higashi Sumiyoshi-ku, Osaka 546-0041 Japan  
**Service & Research Address for United States Consumers:**

**CAT EYE Service & Research Center**

1705 14 th St. 115 Boulder CO 80302

Phone: 303-443-4595 FAX: 303-473-0006

Toll Free: 800-5CAT EYE URL: <http://www.cateye.com>.

**For more information about download software, please see  
CAT EYE web site.**

U.S. Pat. Nos. 4633216/4642606/5089775/5226340 and Pat. Pending

MSC-2Dx 31

## ACCESSORIES

### Replacement part



#166-5150 Lithium battery CR2032

---

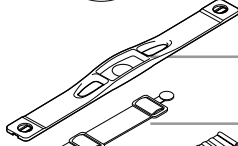

#169-9826 Replacement electrode belt

---

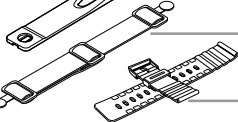

#169-9816 Attachment belt

---

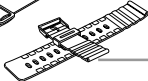

#249-9980 Wrist band kit

---

### Optional part

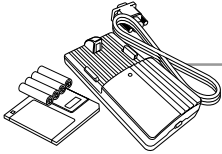

#240-1001 PC download kit

---

Interface unit and download software "e-Train Data™"  
Windows 95/98/2000 compatible  
English version (English version manual attached)  
RS232C connection cable

---

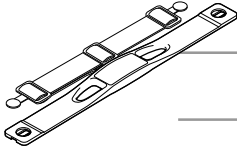

#169-9806 MSC Dx chest belt heart rate sensor kit

---

Multi sport strap (Velcro)

---

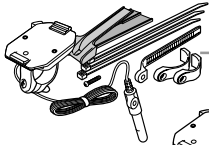

#249-9990 Bracket sensor kit

---



#249-9995 MSC-2Dx (bracket) attachment

---



#169-6070 Wheel magnet

---



#169-9760 Magnet for composite wheel

---



#169-6280 Universal sensor band

---



#249-9970 Attachment kit

---



# Index

## A

AC button -----	7
Aerobic exercise -----	25
Alarm -----	17
All clear -----	7
Anaerobic exercise -----	25
Auto Feature -----	14
Average speed -----	9

## C

Clock -----	8
Setting clock -----	13
Current speed -----	8,9

## E

Elapsed time -----	8
Electrode area -----	11
Electrode belt -----	11

## F

Feature setting -----	7
-----------------------	---

## H

Heart rate -----	8
Heart rate target zone	
Confirming zone stay time -----	16,17
Download -----	17
Resetting -----	17
Zone stay time -----	9
Heart rate sensor -----	10
Heart rate target -----	24, 25

## L

Lap -----	9,15
Lap data download -----	15
Lap data read out -----	15
Recording lap data -----	15
LAP button -----	6
Lap's average heart rate -----	6
Lap's average speed -----	6
Lower display -----	8
LT(Light) button -----	6

## M

Main function -----	6
Maximum heart rate -----	8,25
Maximum speed -----	9
Middle display -----	8
MODE button -----	6

## P

Power saving feature -----	14
----------------------------	----

## R

Record memory -----	18
Checking file -----	19
Data read out -----	22
Finishing record memory -----	21
Prepare for record memory -----	20
Record memory download -----	22
Record memory off -----	21
Record memory stand-by state ----	20
Record memory timing selection --	19
Starting record memory -----	21
Used memory rate (%) -----	19
Resetting -----	7
Resting Heart Rate -----	25

## S

SET/AT button -----	7
Speed pace feature -----	14
S/S(Start/Stop) button -----	7
Sub function -----	6
Switching upper display -----	7

## T

Total distance (Odometer) -----	9
Training level -----	24
Transmitter -----	11
Trip distance -----	9

## U

Upper display -----	8
---------------------	---

## W

Wheel circumference -----	12
A & B -----	13
Confirming wheel circumference -	13
Switching -----	13
Wheel circumference setting screen ---	12