

# INSTRUCTION MANUAL

MCD 782

## CAR MULTIMEDIA SYSTEM DVD/MPEG4 PLAYER

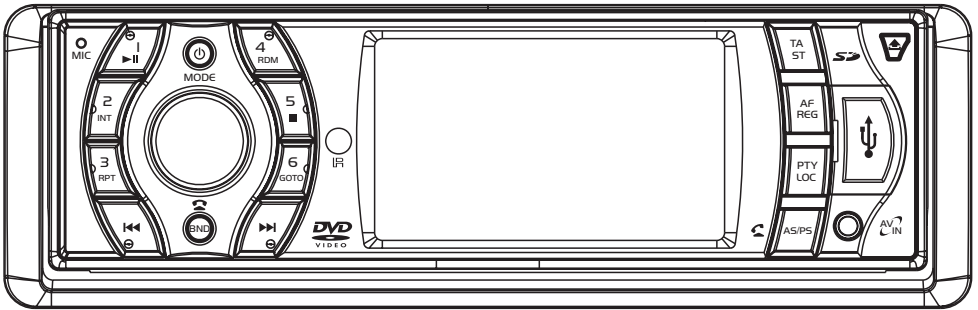

- DVD/VCD/CD/CD-R/CD-RW/MP3/MPEG4 Compatible
- Anti-Shock Mechanism
- FM Stereo Radio
- PLL Synthesizer Tuner
- RDS (Radio Broadcast System) Function
- Front Panel USB Input Port
- SD/MMC Memory card slot
- Built-in Bluetooth hands-free system
- Front panel AV input
- AV Output Socket
- Sub-woofer Output Socket
- 3" Widescreen Digital TFT LCD Display
- ISO Connectors for Power Supply and Speaker Outputs
- 4 x 75W High Power Output

# CONTENTS

<b>Safety Information</b> .....	<b>01</b>
<b>Installation</b> .....	<b>02</b>
<b>Using The Detachable Front Panel</b> .....	<b>04</b>
<b>Wiring Diagram</b> .....	<b>05</b>
<b>Operations</b> .....	<b>06</b>
Location and Function of Keys .....	06
Using The Remote Control.....	07
General Operations.....	08
Radio Operations.....	09
RDS(Radio Data System) Operations.....	10
AV Menu Settings.....	11
Disc Operations.....	12
Special Disc Operations.....	15
Data Disc Play Operations .....	17
USB Operations.....	18
SD/MMC Memory Card Operations.....	18
AV IN Operations.....	18
Bluetooth Hands-free Function.....	19
<b>Setup</b> .....	<b>21</b>
System Setup.....	21
Language Setup.....	23
Audio Setup.....	23
Digital Setup.....	23
<b>Attachment</b> .....	<b>24</b>
<b>Trouble Shooting</b> .....	<b>25</b>
<b>Specifications</b> .....	<b>26</b>

## Safety Information

### **CAUTION:**

Mobile DVD player is a class 1 laser product. However this mobile DVD player uses a visible/invisible laser beam which could cause hazardous radiation exposure if directed. Be sure to operate the mobile DVD player correctly as instructed.

Use of controls or adjustments or performance of procedures other than those specified herein may result in hazardous radiation exposure.

Do not open covers and do not repair yourself. Refer servicing to qualified personnel.

### **WARNING:**

- To reduce the risk of fire or electric shock, do not expose this equipment to rain or moisture.

- To reduce the risk of fire or electric shock, and annoying interference, use only the recommended accessories.

- This device is intended for continuous operation.





This product incorporates copyright protection technology that is protected by method claims of certain U.S. patents and other intellectual property rights owned by macro vision Corporation and other rights owners. Use of this copyright protection technology must be authorized by Macro vision Corporation, and is intended for home and other limited viewing uses only unless otherwise authorized by Macro vision Corporation. Reverse engineering or disassembly is prohibited.

### **Region Management Information**

Region Management Information: This Mobile DVD Player is designed and manufactured to respond to the Region Management Information that is recorded on a DVD disc. If the Region number described on the DVD disc does not correspond to the Region number of this Mobile DVD Player, this Mobile DVD Player cannot play this disc.

## **DISC NOTES**

### **Disc formats supported by this player**

	<b>DVD</b> 12 CM disc
	<b>VCD</b> 12 CM disc
	<b>CD</b> 12 CM disc
	<b>MP3</b> 12 CM disc
<b>MPEG4</b>	<b>MPEG4</b> 12 CM disc

### **Handling and Cleaning**

- Dirt, dust, scratches and warping discs will cause disoperation.
- Do not place stickers or make scratches on discs.
- Do not warp discs.
- A disc should always be kept in its case when not in use to prevent from damage.
- Do not place discs in the following places:
  1. Direct sunlight.
  2. Dirty, dusty and damp areas.
  3. Near car heaters.
  4. On the seats or dashboard.

### **Disc Cleaning**

Use a dry soft cloth to wipe the surface. If the disc is quite dirty, Use a soft cloth slightly moistures with isopropyl (rubbing) alcohol. Never use solvents such as benzene, thinner or conventional record cleaners as they may mar the surface of the disc.

### **Note:**

A disc may become somewhat scratched (although not enough to make it unusable) depending on the way it is handled and conditions in the usage environment. Note these scratches are not an indication of any problem with the player.

Label side up



Do not touch the underside of the disc



Do not bend



Wipe the disc from center toward the outside edge

### **Preparing New Discs with Rough Spots**

A new disc may have rough edges on its inside and outside edges. If a disc with rough edges is used, the proper setting will not be performed and the player will not play the disc. Therefore, remove the rough edges in advance by using a ballpoint pen or pencil as shown on the right. To remove the rough edges, press the side of the pen or pencil against the inside and outside edges of the disc.

Rough spots on outside edge

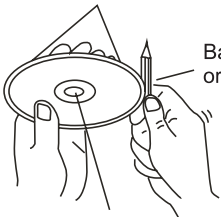

Ball point pen or pencil

Rough spots on inside edge

## **Installation**

### **Notes:**

- Choose the mounting location where the unit will not interfere with the normal driving function of the driver.
- Before finally installing the unit, connect the wiring temporarily and make sure it is all connected up properly and the unit and the system work properly.
- Use only the parts included with the unit to ensure proper installation. The use of unauthorized parts can cause malfunctions.
- Consult with your nearest dealer if installation requires the drilling of holes or other modifications of the vehicle.
- Install the unit where it does not get in the driver's way and cannot injure the passenger if there is a sudden stop, like an emergency stop.
- If installation angle exceeds 30° from horizontal, the unit might not give its optimum performance.

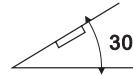

- Avoid installing the unit where it would be subject to high temperature, such as from direct sunlight, or from hot air, from the heater, or where it would be subject to dust, dirt or excessive vibration.

### **Din Front/Rear-Mount**

This unit can be properly installed either from 'Front' (conventional DIN Front-mount) or 'Rear' (DIN Rear-mount installation, utilizing threaded screw Holes at the sides of the unit chassis). For details, refer to the following illustrated installation methods.

### **Take Out Screw Before Installation**

Before install the unit, please remove the two screws.

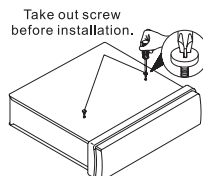

# 1. DIN FRONT-MOUNT (Method A)

## Installation Opening

This unit can be installed in any dashboard having an opening as shown below:

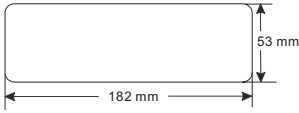

## Installing the unit

Be sure you test all connections first, and then follow these steps to install the unit.

1. Make sure the ignition is turned off, and then disconnect the cable from the vehicle battery's negative (-) terminal.
2. Disconnect the wire harness and the antenna.
3. Press the OPEN (  ) button to remove the control panel (For details, refer to 'USING THE DETACHABLE FRONT PANEL').
4. Lift the top of the outer trim ring then pull it out to remove it.
5. Use the two supplied release keys to remove the unit from the mounting bracket. Insert the left ("L") and right ("R") release keys as far as they will go (with the notches facing up) into the appropriate slots at the middle left and right sides of the unit. Then slide the sleeve off the back.

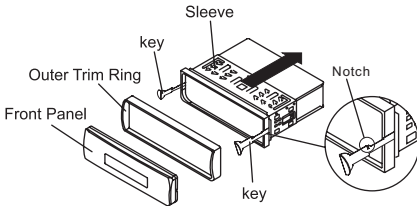

6. Mount the sleeve by inserting the sleeve into the opening of the dashboard and bend open the tabs located around the sleeve with a screwdriver. Not all tabs will be able to make contact, so examine which ones will be most effective. Bending open the appropriate tabs behind the dashboard to secure the sleeve in place.

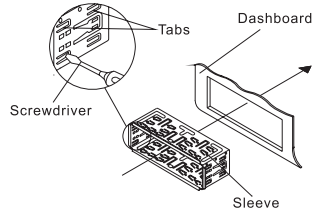

7. Reconnect the wire harness and the antenna and be careful not to pinch any wires or cables.
8. Slide the unit into the sleeve until it locks into place.
9. To further secure the unit, use the supplied metal strap to secure the back of the unit in place. Use the supplied hardware (Hex Nut (M5mm) and Spring Washer) to attach one end of the strap to the mounting bolt on the back of the unit. If necessary, bend the metal strap to fit your vehicle's mounting area. Then use the supplied hardware (Tapping Screw (5x25mm) and Plain Washer) to attach the other end of metal strap to a solid metal part of the vehicle under the dashboard. This strap also helps ensure proper electrical grounding of the unit.

Note to install the short threading terminal of the mounting bolt to the back of the unit and the other long threading terminal to the dashboard.

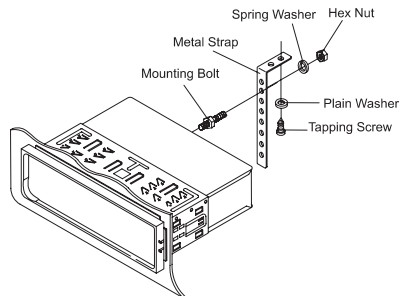

10. Reconnect the cable to the vehicle battery's negative (-) terminal. Then replace the outer trim ring and install the unit's front panel.

## Removing the unit

1. Make sure the ignition is turned off, and then disconnect the cable from the vehicle battery's negative (-) terminal.
2. Remove the metal strap attached the back of the unit (if attached).
3. Press the release button to remove the front panel.
4. Lift the top of the outer trim ring then pull it out to remove it.
5. Insert both of the supplied keys into the slots at the middle left and right sides of the unit then pull the unit out of the dashboard.

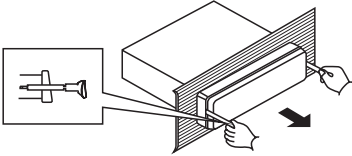

## 2. DIN REAR-MOUNT (Method B)

If your vehicle is a Nissan, Toyota, follow this mounting instruction. Use the screw holes marked T (Toyota), N (Nissan) located on both sides of the unit to fasten the unit to the factory radio mounting brackets supplied with your vehicle.

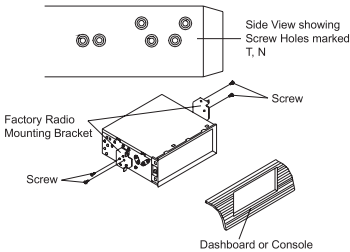

Fasten the unit to the factory radio mounting brackets. Align the screw holes on the bracket with the screw holes on the unit, and then tighten the screws (5x5mm) on each side.

Note: the outer trim ring, sleeve and the metal strap are not used for method B installation.

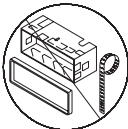

## Using The Detachable Front Panel

### REMOVING AND PROTECTING DETACHABLE FRONT PANEL

The front panel of the unit may be removed as a theft deterrent. After removing the front panel, use the case provided to keep the front panel from getting damaged.

1. Press the OPEN button to flip down the front panel.

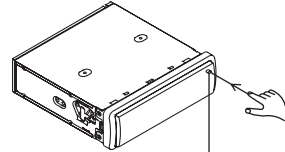

OPEN button

2. Grasp the right side of the front panel, then gently push the front panel towards the left side before pulling it out from the unit.

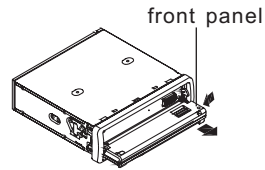

front panel

3. Store the front panel in the protective case provided for safe keeping.

protective case

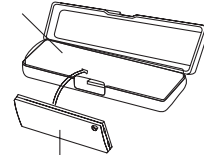

front panel

### TO ATTACH THE FRONT PANEL

Hold the right side of the front panel with the plate facing down.

First attach the left side of the front panel to the unit by inserting the hole into the left holder. Then slightly push it leftwards and attach the right side hole into the right holder. Finally push up the front panel.

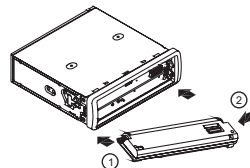

# Wiring Diagram

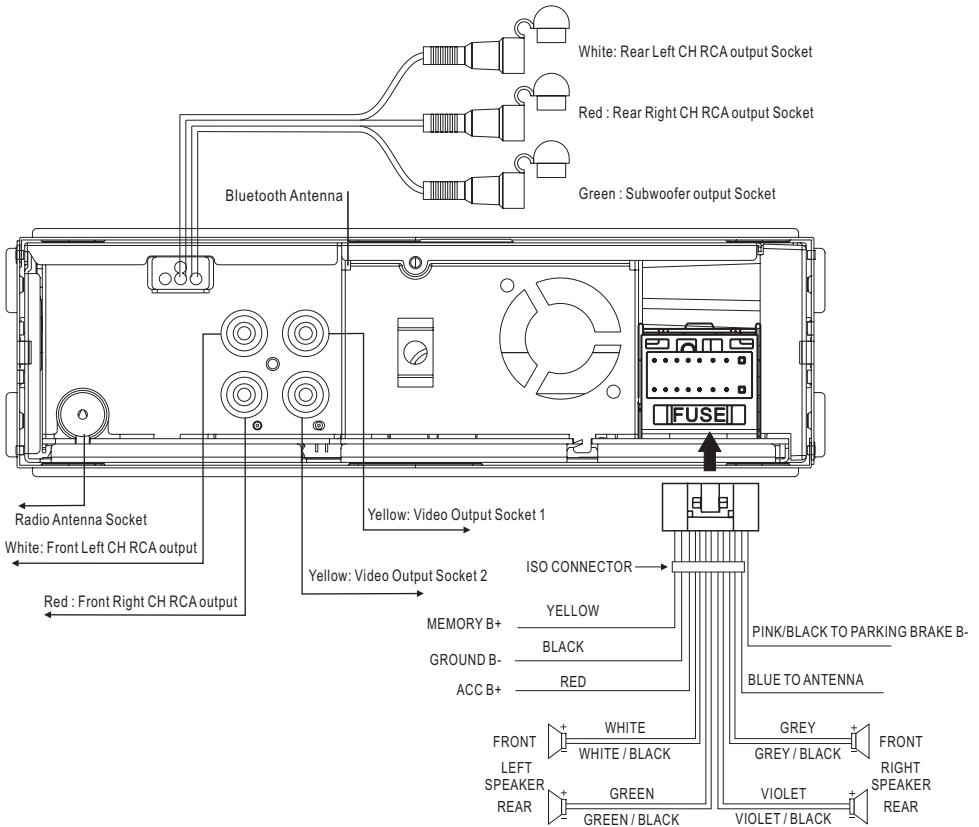

## Connecting the Parking brake wire to the vehicle's parking brake system

The "PINK/BLACK PARKING BRAKE" wire must be connected to the parking brake system of your vehicle. The unit will only play videos when the parking brake system is engaged, if the parking brake system is not engaged, the TFT screen will display the message "**DISABLED WHILE DRIVING**". This is a safety feature designed to prevent the driver from watching a video while driving. The video output of this unit is not affected by this.

### Note:

In radio, disc playing mode, the images will be displayed on the screen whether or not the parking brake system is engaged.

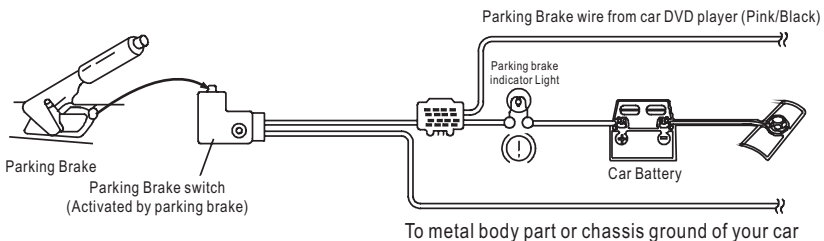

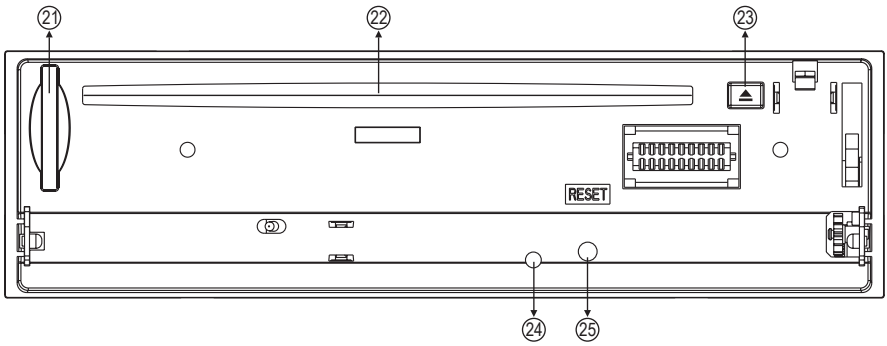
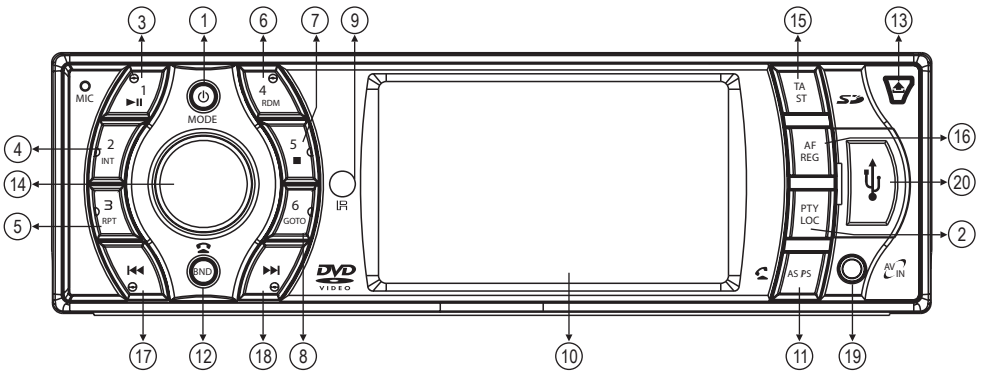



# Using The Remote Control

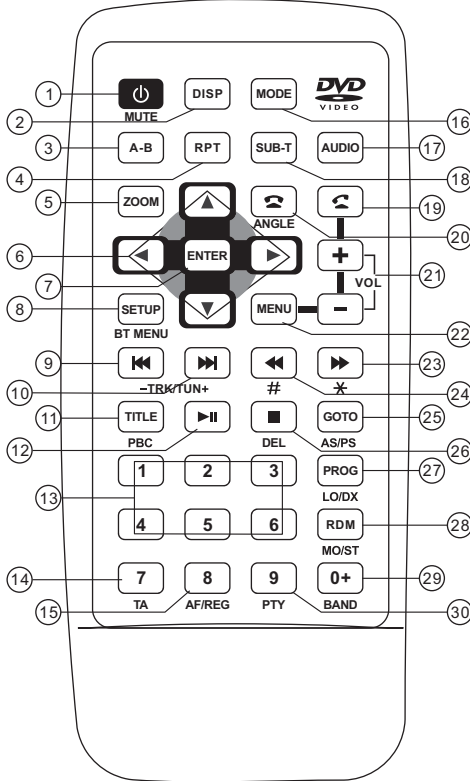

- (23) ►► Fast Forward Button, ✱ Button
- (24) ◀◀ Fast Reverse Button, # Button
- (25) GOTO Button  
AS/PS (Automatic Search & Preset memory Scan) Button
- (26) ■ (Stop) Button, DEL (Delete) Button
- (27) PROG(Programmed play mode) , LOC/DX Button
- (28) RDM (Random) Button, MO/ST Button
- (29) Numeric 0,+ Button, BAND Button
- (30) PTY(Program Type) Button, Numeric 9 Button

## Remark:

- ◆ Before you using the remote control, please take the transparent insulator slice off the bottom of remote control.
- ◆ Point the remote control at the remote sensor within 2 meters.
- ◆ It may not be possible to operate the remote control if the remote control sensor is exposed to direct sunlight.
- ◆ Operation angle: about  $\pm 30^\circ$  in each the direction of the front of the remote sensor.
- The remote control is a small, lightweight precision device. To avoid damage, short battery life, operational errors and poor response, observe the following.
  - Do not subject the remote control to excessive shock.
  - Do not put in a trouser pocket.
  - Keep away from food, moisture and dirt.
  - Do not place in direct sunshine.

## Descriptions of Function Controls

- (1) Power (⏻) Button, MUTE Button
- (2) DISP(Display)
- (3) A-B Button
- (4) RPT (Repeat) Button
- (5) ZOOM(Zoom in /Zoom out) Button
- (6) Cursor Buttons (◀/▶, ▲/▼)
- (7) ENTER Button
- (8) SETUP Button, BT MENU Button
- (9) ◀◀ Tune down, Seek down, track previous Button
- (10) ▶▶ Tune up, Seek up, track next Button
- (11) TITLE(DVD Title Menu) / PBC(Playback Control) Button
- (12) ▶|| (Play/Pause) Button
- (13) Pre-set M1~M6 Button, Numeric 1~6 Button
- (14) TA (Traffic Announcement) Button, Numeric 7 Button
- (15) AF(List of Alternative Frequencies) Button, REG(Regional Program) Button, Numeric 8 Button
- (16) MODE Button
- (17) AUDIO(Audio Setup Select) Button
- (18) SUB-T(Subtitle Language select) Button
- (19) ■ Button
- (20) ◀,ANGLE(Camera angle selection for some disc) Button
- (21) Volume +/- Button
- (22) MENU Button

## Battery replacement

Battery type: a button cell lithium battery (CR2025 3V)

1. Remove the battery holder by pressing the locking tab with your thumb and pulling it out.

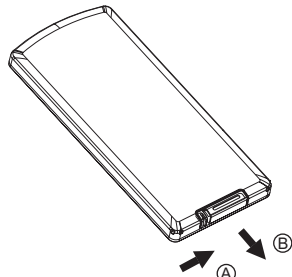

2. Replacing the battery  
Replace the battery with the same type and the (+) side facing up.

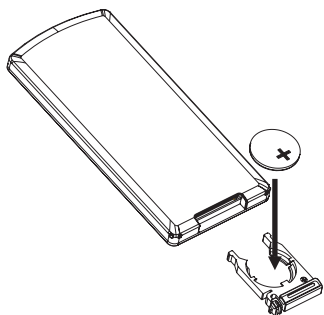

3. Closing the cover  
Gently push in the holder until securely locked into place.

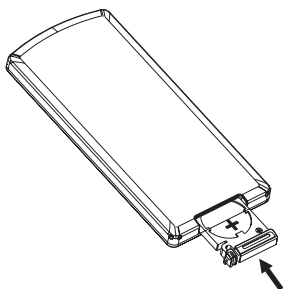

## General Operations

### Reset the unit

Operating the unit for the first time, after replacing the car battery or changing the connections, you must reset the unit.

1. Turn off the unit power.
2. Press the **OPEN** (▲) button and remove the front panel, then press the **RESET** button with a ballpoint or similar object to restore the unit to the original factory settings.

### Power on/off

In power off mode, switch on the unit by pressing any button except the **OPEN** button and the **EJECT** (▲) button or inserting a disc to disc slot, USB device to USB port or SD/MMC card to card slot. When the system is on, press and hold the **POWER** (⏻) button long to turn off the unit.

### Adjusting the volume level

Rotate the **VOL+/-** knob on the head unit, or use the **VOL+** or **VOL-** button on the remote control to adjust volume level.

### Anti-theft LED Indicator

Designed as a theft deterrent, the red LED will flash when the unit is turned off and the front panel is removed.

### ESP function

This car DVD player has the electronic shockproof feature. So that if the unit skips due to rough road conditions, the music or video will be uninterrupted.

### Mute on/off

When the unit is switched on, press the **MUTE** button to turn off the sound instantly. Press the **MUTE** again to return it to the prior sound level.

### To select playback mode

In power on mode, press **MODE** button repeatedly to select the different modes in the following sequence: DISC(with a disc inside the disc slot), USB(with USB device inserted), SD/MMC(with SD/MMC card inserted), BT, AV IN, TUNER mode.

### Last position memory feature

- During disc, USB, SD/MMC card playback, press and hold the **POWER** button to turn off the unit, when you next switch on it, the unit will resume playing from the point that it was interrupted.

-During disc, USB, SD/MMC card playback, press the **MODE** button to switch to a different mode, when you next return to the previous disc, USB, SD/MMC card playback mode again, the unit will resume playing from the point that it was interrupted.

Press and hold the **▶▶** or **◀◀** button until “MANU” appears on the TFT screen, it will change into manual searching mode.

### **- Manual search mode:**

Press the **▶▶** or **◀◀** button repeatedly to manually search upward or downward step by step for the desired radio station within the current band. For fast manual searching, press and hold the **▶▶** or **◀◀** button.

In manual search process, if the both buttons haven't been pressed within 5 seconds, it will change into automatic search mode automatically. “MANU” disappears on the TFT screen.

### Stereo/Mono

FM station is received in stereo mode. However, if the signal weak or reception is not as good as you would like, switching to MONO mode usually improves the overall sound quality. Press and hold the **TA/ST** button on the head unit or briefly press **MO/ST** on the remote control to choose FM STEREO or MONO audio effect.

## Radio Operations

### To select the radio mode

Press the **MODE** button to select the radio mode. You will see the following radio screen on the TFT screen.

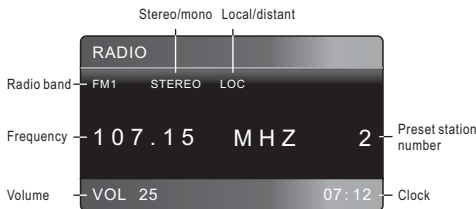

### To select a radio band

In radio mode, Press the **BAND** button repeatedly to select one of the three radio broadcasting bands: ->FM 1-> FM 2 -> FM 3 ->.

### Auto/ Manual tuning

#### **- Automatic search mode:**

Press the **▶▶** or **◀◀** button, the automatic search will start. It will search upward or downward for the strong signal radio station within the current band.

### Local/Distant

In urban settings, most stations are strong enough and it should be set in LOCAL mode. Switch to DX (distant) mode to search for stations with weaker signals. Press and hold the **PTY/LOC** button on the head unit or briefly press the **LO/DX** button on the remote control to choose local reception or DX(distant) reception mode.

### To store / recall a preset radio stations

You can store up to a total of 18 radio stations in the memory (18 FM), manually or automatically.

#### **- To store a station:**

- Select a band (if needed)
- Select a station by **▶▶** or **◀◀** button, refer to auto / manual tuning.
- Hold a Pre-set button (**M1-M6**) for at least 2 seconds.

#### **- To recall a station:**

- Select a band (if needed).
- Press a preset button (**M1-M6**) briefly to recall the stored station.

## **Auto store / Preset scan**

### **- Preset scan:**

Press the **AS/PS** button to scan each preset station. It will play a station for a few seconds, then go to next station until all 6 stations are scanned, finally the radio will play at the preset station where scanning started. The preset station number on the LCD will flash during the process. When you hear a station that you wish to listen to, press the **AS/PS** again to stop the preset scanning.

### **- Auto store:**

Press and hold the **AS/PS** button for more than 2 seconds to start auto store. The radio will scan from the lowest frequency, and automatically store the 6 strongest stations into the preset memories. When auto store is complete, the radio will start preset scan to the stored 6 station.

## **RDS (Radio Data System) Operations**

### **Setting RDS mode**

Briefly press the **AF/REG** button to turn the RDS mode on/off.

Whenever RDS is on, symbol "**AF**" appears on the TFT screen.

Program name is displayed when receiving an RDS station.

"**AF**" starts blinking if the broadcasting signals getting worse. "**ALARM**" will be displayed when an emergency broadcasting is received, meanwhile sound output level will be automatically adjusted to the preset output level when the volume level is set at minimum.

### **AF (alternative frequency) function**

Press **AF/REG** button short to switch AF mode on or off. There are 3 state of the segment "**AF**" on the LCD display:

**Segment "AF" off:** AF switching mode off.

**Segment "AF" on:** AF switching mode on, and has RDS information.

**Segment "AF" flashing:** AF switching mode is on, but RDS information is not received yet.

When AF switching mode is selected, the radio checks the signal strength of the AF all the time. The interval of checking time of each AFs depends on the signal strength of current station, from a few minute for strong station to few seconds for weak station. Every time that new AF is stronger than current station, it switches over to that frequency for very short time. Because the mute time of AF switching or checking time is very short, it is almost inaudible in case of normal program. During FM mode, when AF is on, manual store, Auto store/preset scan function can only receive and save RDS program.

### **REG(Regional Program) function**

Press and hold the **AF/REG** button for 2 seconds to switch on or off region mode. Some broadcasting stations change their program from normal broadcasting to regional broadcasting for a certain time period.

When region is on, the current listening program remains unchanged. When region is off, it allows the reception moved to the regional station.

### **TA(Traffic Announcement) Function**

Briefly press the **TA** button to turn TA search mode on or off.

When **TA** search mode is on and a traffic announcement is transmitted:

- Switch to the traffic announcement mode from any audio mode including DVD(CD/MPEG4/MP3), USB/SD/MMC or AV IN.
- Switch on the traffic announcement automatically when the receiver is in a waiting reception mode and the audio signal is muted.
- When the traffic announcement is over, the initial operation mode will be restored.
- If the volume level was under the threshold point, it will be raised to the threshold point.
- When **TA** mode is on, segment "**TA**" is turned on.
- When a TP station is received, segment "**TP**" is turned on.

## TA interruption function

The current traffic announcement is cancelled by pressing the **TA** button. But the **TA** mode will not be off.

## To select program type

Briefly press the **PTY** button to enter or exit the program type list. After tuning on the PTY list, the display as follows:

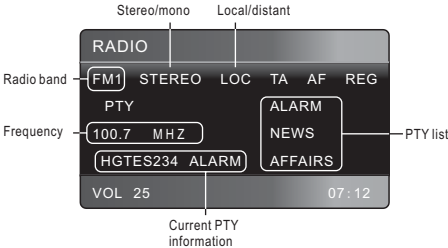

Press the **▶▶/◀◀** button on the head unit or **▲/▼** button on the remote control, you can select different program types as follows:

NEWS -> AFFAIRS -> INFO -> SPORT  
 -> EDUCATE -> DRAMA -> CULTURE ->  
 SCIENCE -> VARIED -> POP M ->  
 ROCK M -> EASY M -> LIGHT M ->  
 CLASSICS -> OTHER M -> WEATHER ->  
 FINANCE -> CHILDREN -> SOCIAL ->  
 RELIGION -> PHONE IN -> TRAVEL ->  
 LEISURE -> JAZZ -> COUNTRY M ->  
 NATION M -> OLDDIES -> FOLK M ->  
 DOCUMENT -> TEST -> ALARM ->  
 NEWS

After a few seconds, the unit will search your selected program type automatically. The PTY search stops when the unit finds a station with the selected program type, otherwise, the PTY search automatically exits to normal mode. During the PTY search process, press any key to stop the PTY search.

## AV menu settings

### AV Menu Overview

You can adjust various settings of the unit from the AV menu.

The AV menu contains the menu items and submenus shown in the figure below:

1. Press the **VOL+/-** knob on the head unit, or the **MENU** button on the remote control to activate AV menu.
2. Press the **▶▶** or **◀◀** button on the head unit, or **▲/▼/◀/▶** button on the remote control to select a menu item (AUDIO, PICTURE, SETUP).
3. Press the **VOL+/-** knob on the head unit, or the **ENTER** button on the remote control to access your selected menu item.
4. Rotate the **VOL+/-** knob on the head unit, or press the **VOL+** or **VOL-** button on the remote control to adjust the item you have selected.
5. Repeat steps 2, 3 and 4 to adjust other items if necessary.
6. Press the **MODE** button on the head unit or **ZOOM** button on the remote control to return to the previous menu.
7. Press the **MENU** button on the remote control to finish the procedure.

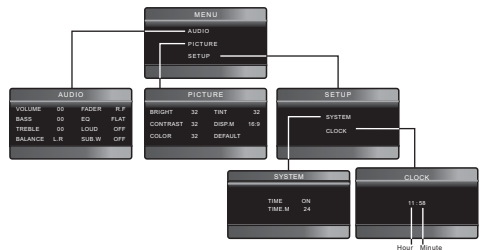

## Audio Menu

AUDIO			
VOLUME	00	FADER	R.F
BASS	00	EQ	FLAT
TREBLE	00	LOUD	OFF
BALANCE	L.R	SUB.W	OFF

1. Press the **▶▶** or **◀◀** button on the head unit, or **▲/▼/◀/▶** button on the remote control to select a menu item to adjust.
2. Rotate the **VOL+/-** knob on the head unit, or press the **VOL+** or **VOL-** button on the remote control to adjust the item you have selected.

**Volume level:** 0 ~ 63;

**Bass level:** -7 ~ +7;

**Treble level:** -7 ~ +7;

**Balance:** 15L ~ 15R; This setting adjust the balance between the left and right speakers.

**Fader:** 15R ~ 15F; This setting adjust the balance between the front and rear speakers.

**Equalization:** Flat, Classes, Rock, Pop; You can select a preset equalizer settings.

**Loudness:** on/off; Loudness introduces a special low- and high-frequency emphasis at low listening levels.

**Sub-woofer:** on/off; This unit is equipped with a sub-woofer output. If you connect this output to a powered sub-woofer or amplifier & sub-woofer system, enable this output by select ON.

## Picture Menu

PICTURE			
BRIGHT	32	TINT	32
CONTRAST	32	DISP.M	16:9
COLOR	32	DEFAULT	

1. Press the **▶▶** or **◀◀** button on the head unit, or **▲/▼/◀/▶** button on the remote control to select a menu item to adjust.
2. Rotate the **VOL+/-** knob on the head unit, or press the **VOL+** or **VOL-** button on the remote control to adjust the item you have selected.

**Bright:** 0 ~ 63; Adjust this setting if the picture is too bright or too dark.

**Contrast:** 0 ~ 63; Use this setting to adjust the contrast of the picture.

**Color:** 0 ~ 63; Use this setting to adjust the color of the picture.

**Tint:** 0 ~ 63; Use this setting to adjust the tint to make colors appear most natural.

### Disp.M: (Display monitor type)

Select a setting which is appropriate to the monitor you are using.

#### Monitor type



- **16:9:** Select this when the aspect ratio of your monitor is 16:9 (widescreen).

- **4:3:** Select this when the aspect ratio of your monitor is 4:3. If you view a wide screen picture, the black bars will appear to fill the left and the right side of the screen.

**Default:** Using this setting to make the picture menu setup restore to factory status.

After select this menu item, rotate the **VOL+/-** knob on the head unit or press the **VOL+** or **VOL-** button, you can make the picture setup restore to factory default setup.

## Setup Menu

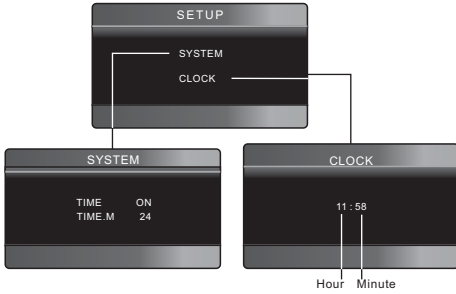

1. Press the **▶▶** or **◀◀** button on the head unit, or **▲/▼/◀/▶** button on the remote control to select a menu item to adjust.
2. Rotate the **VOL+/-** knob on the head unit, or press the **VOL+** or **VOL-** button on the remote control to adjust the item you have selected.

### Time: ON/OFF

Turns the clock display ON/OFF.

### Time. M: 12/24

Use this menu item to select 12 hour clock mode or 24 hour clock mode.

### Clock setting:

Use this menu item to set or make changes to the time displayed on the clock after select this menu item,

1. Press the **▶▶** or **◀◀** button on the head unit, or **◀/▶** button on the remote control to select hour or minute.
2. Rotate the **VOL+/-** knob on the head unit or press the **▲/▼** button on the remote control, you can adjust the hour or minute.

## Disc Operations

### Loading/Removing a Disc

1. Press the **OPEN** (**⏏**) button on the front panel to flip down the front panel and then insert a disc into the disc slot with the label side facing upward; and close the front panel, the player will play the disc automatically.
2. To eject the disc, press the **OPEN** (**⏏**) button to open the front panel and then press the **EJECT** (**⏏**) button.

### To select the disc mode

Press the **MODE** button to select the disc mode, if necessarily.

### Disc Information Screens

When you insert a DVD disc, a screen with information similar to the one below will appear when you press and hold the **SUB-T** button.



When you insert a CD, MP3, WMA, JPEG, or MPEG4 disc, the following screen appears.

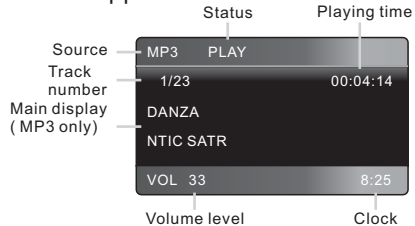

Press the **DISP** button to display the following screen.

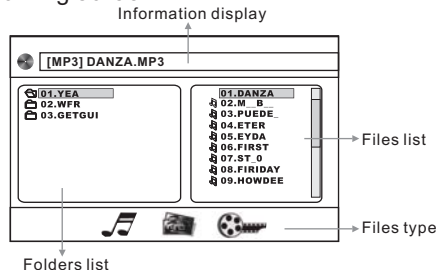

For MP3/JPEG/MPEG4:

Use the cursor buttons (**▲/▼/◀/▶**) to

select a file or folder, then press the **ENTER** button to confirm your selection. If you select a file, it will be played. If you select a folder its contents(files) will be displayed in the file list.

For CD:

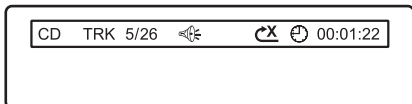

### **Single Track Selection**

Press the ►► or ◀◀ button on the head unit to skip to the next or previous track.

### **Fast Forward / Fast Reverse**

Press and hold the ►► or ◀◀ button on the head unit repeatedly or press the ► or ◀ button on the remote control to fast forward or fast reverse with different speed as follows:

**FORWARD:** 2X → 4X → 8X → 20X → PLAY  
**BACKWARD:** 2X → 4X → 8X → 20X → PLAY

In fast forward or fast reverse mode, press the ►|| button on the head unit or remote control to return to normal playback.

### **Pause Playback**

Press the ►|| button on the head unit or remote control to pause disc playback. Press it again to resume playback.

### **Stopping Playback**

Press the ■ button on the head unit or remote control once to stop playback. Press the ►|| button to resume playback. Press the ■ button twice and then press the ►|| button to stop playback and return to the first track on the disc.

### **Repeat Playback**

Use this function when you wish to repeat a whole disc, a track or a directory on the disc.

1. Press the **RPT** button on the head unit or remote control repeatedly to select the different repeat modes.
2. For different kinds of disc, pressing the **RPT** button has different effects.

### **For CD/VCD/SVCD:**

REP 1 → REP ALL → REP OFF

### **For MP3:**

REP 1 → REP DIR → REP ALL → REP OFF

### **For DVD:**

REP CHAPTER → REP TITLE → REP OFF

Note:

- REP 1:** Only one track(file) is repeated.
- REP DIR:** A single folder of tracks(files) is repeated.
- REP CHAPTER:** A chapter is repeated.
- REP TITLE:** A title is repeated.
- REP ALL:** An entire disc is repeated.
- REP OFF:** Normal playback mode.

Note: The repeat feature is not supported for VCD 2.0 discs when PBC(Playback Control) is on.

### **A-B Repeat (Paragraph repeat mode)**

A-B repeat allows you to specify a paragraph of the current track to be repeated.

1. Press the **A-B** button to set the starting point of the section you wish to repeat. "REPEAT A-" will be visible on the screen.

2. Press the **A-B** button to set the end point of section you wish to repeat. "REPEAT A-B" will be visible on the screen.

The unit will repeat the section of the current track you've just chosen from point "A" to "B". To return to normal playback, press the **A-B** button again. "A-B CANCEL" will be visible on the screen.

### **Playing in Random order**

Press the **RDM** button on the head unit or remote control to switch the random mode ON/OFF. In random mode, tracks(files) on the disc will be played in random order.

### **Previewing all tracks (Intro scan)(only for CD/VCD)**

Press the **INT** button to play the first 10 seconds of each track on the current



disc. Press it again to stop intro scan and return to normal playback.

## Special Disc Operations

### Disc Menu Operations

Menu-driven playback is possible while playing a disc with menu-driven features or when playing a VCD with PBC(Playback Control).

1. Press the **TITLE/PBC** button, a title list or disc menu will appear on the screen.
2. Use cursor button (**▲/▼/◀/▶**) to select a item on the menu you wish to play, then press the **ENTER** button to confirm your selection. (Note: On some disc, you can select the items with the numeric button.)

### Multi-subtitle Language Function

#### **For DVD:**

Some DVD discs have multiple languages, allowing you to select the subtitle language recorded on disc. Press the **SUB-T** button to switch between the different languages recorded on the disc.

#### **Notes:**

- Not all discs will allow changing the subtitle during playback. In these cases, select the desired subtitle language from the DVD's menu.
- There may be delay before the selected subtitle language appears.
- For some discs, the subtitles will be displayed even when this is set to off.
- The number of available languages varies from disc to disc.

### Multi-Audio Language

#### **For DVD:**

For DVD discs which have multiple language soundtracks, you can press the **AUDIO** button to switch between the audio languages recorded on the disc.

#### **Note:**

- The number of available languages varies from disc to disc.
- Some discs only contain one soundtrack language.
- Not all discs will allow changing the audio language during playback. In these cases, select audio language from the DVD's menu.

#### **For VCD/SVCD:**

Some VCD/SVCD discs which have multiple audio channels, you can select the desired audio channel to play by pressing the **AUDIO** button.

**STEREO:** Normal stereo (left / right) playback.

**MONO L:** Left audio channel only.

**MONO R:** Right audio channel only.

Notes:

- some disc only contain one audio channel.

### Multi-angle Function

You can view the same scene at different angles if the disc has been recorded with multiple viewing angles. Press the **ANGLE** button during playback. The following information will be shown:



This example indicates that you are currently viewing the first of three available camera angles. Press the **ANGLE** button to select a different angle.

#### **Notes:**

- Some time may be required for the angle to change.
- Depending on the disc, the viewing angle may switch in one of two ways.
  1. Seamless: The angle switches smoothly.
  2. Non-seamless: When the angle is switched, a still picture is displayed first, after which the angle switches.
- The number of available viewing angles varies from disc to disc.

- The function only works for discs having scenes recorded at different angles.

### ZOOM Function

Press the **ZOOM** button repeatedly to enlarge or reduce the size of image according to the disc as follows:

ZOOM 2 → ZOOM 3 → ZOOM 4 → ZOOM 1/2 → ZOOM 1/3 → ZOOM 1/4 → ZOOM OFF

In zoom in mode, press the cursor button (▲/▼/◀/▶) to move the zoomed-in area.

### Programmed Play Function

Press the **PROG** button during playback to activate the programming editing interface as follows:

**For VCD/SVCD/CD:**

PROGRAM			
1 [ ]	5 [ ]	9 [ ]	13 [ ]
2 [ ]	6 [ ]	10 [ ]	14 [ ]
3 [ ]	7 [ ]	11 [ ]	15 [ ]
4 [ ]	8 [ ]	12 [ ]	16 [ ]

PLAY CLEAR

**For DVD/MP3/MPEG4:**

PROGRAM			
T	C	T	C
1---	5---	9---	13---
2---	6---	10---	14---
3---	7---	11---	15---
4---	8---	12---	16---

PLAY CLEAR

- 1) Use the cursor button (▲/▼/◀/▶) to select the item that you want to program. The item you selected will be highlighted.
- 2) Input the track number that you want to program using the numeric button (0-9) on the remote control.
- 3) Press the cursor button (▲/▼/◀/▶) to move to "PLAY" operation button and then press the **ENTER** button to program the playback sequence.

### On Screen Display

Press and hold the **SUB-T** button during playback to display information of the current disc on the screen:

**For DVD Disc Information:**

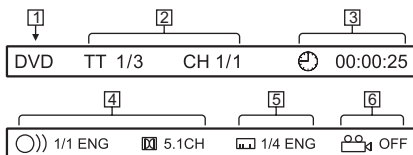

**For VCD/CD/MP3/JPEG:**

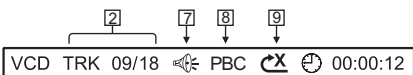

### **1. Disc type**

### **2. Playback information**

**TT 1 / 3:** Current title/ Total title;  
**CH 1 / 1:** Current Chapter/ Total Chapter;  
**TRK 9 / 18:** Current Track/ Total Track.

### **3. Time indication**

⌚ : Elapsed playing time of the disc;  
 ⌚ : Remaining time of the disc;  
 T: Elapsed playing time of the current title;

T-: Remaining time of the current title;

C: Elapsed playing time of the current chapter;

C-: Remaining time of the current chapter.

### **4. Audio language or audio channel indication**

### **5. Subtitle language indication**

### **6. View angle indication**

### **7. Mute indication**

### **8. PBC indication (only for VCD with PBC)**

### **9. Repeat playback indication**

- ⌂ : One track repeat playback;
- ⌂ : One directory repeat playback;
- ⌂ : The whole disc repeat playback;
- ⌂ : Exit repeat playback mode;

### GOTO Function

Press the **GOTO** button, the screen will display the following message.

**For DVD:**

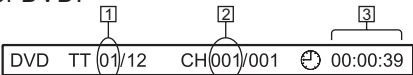

**For VCD/CD/MP3:**



**- To search for a particular Title, Chapter, or Track**

1. Use the cursor button (▲/▼/◀/▶) to highlight 1 (track number), 2 (chapter number) or 4 (VCD track number).

2. Then enter a number with the number button to input the desired Title/Chapter, Track, then press the **ENTER** button to confirm your selection.

**- To search for a particular point by playing time**

1. Use the cursor button (▲/▼/◀/▶) to move to 3 (time).

2. Use the number buttons on the remote control to input the elapsed playing time of the current title or the disc, and then press the **ENTER** button to confirm the selection.

**Data Disc Play Operations**

When you insert a data disc containing audio(MP3), movie(MPEG4) or picture(JPEG) files into the disc slot, the following main menu will appear:

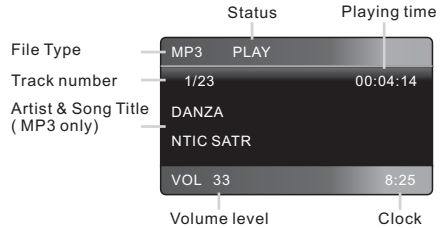

Press the **TITLE** button on the remote control to change the source. Press the **DISP** button on the remote control to switch to the following interface:

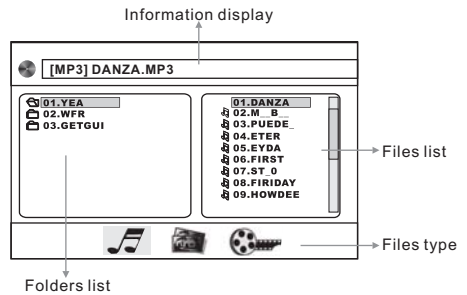

Use the cursor buttons (▲/▼/◀/▶) to select a item on the screen you wish to play, then press the **ENTER** button to confirm your selection.

Press the **TITLE** button to switch between AUDIO(🎵), JPEG(🖼️) and MOVIE(🎬) mode.

Playback type icons :

- 🎵 AUDIO Playback mode (default)
- 🖼️ JPG Playback mode (default)
- 🎬 MOVIE Playback mode (default)

Press the **STOP**(■) button to return to the main menu.

## USB Operations

### Using the USB stick:

This disc player features a front panel USB interface. A USB device can be connected to this port. When you insert a USB stick through the port, the DVD player will search for the MP3/WMA files and start to play them automatically. If you insert a SD/MMC card into the SD/MMC card slot or a disc into the disc slot while reading the USB stick, the unit will play the disc. You can press **MODE** button to switch to USB playback mode.

### Note:

- Use the USB adaptor cable, if necessary.
- The operations of playing MP3/WMA files in the USB is the same as the MP3/WMA operation described in the CD/MP3/WMA disc operations.
- When reading the USB stick, please don't touch or remove it.
- If following the instruction above, the unit can't read the file in the USB stick, please check if the device is in good condition, or take it out then insert it into the USB port once more.
- The main unit can only support the standard USB-memory device.
- USB MP3 player is not a standard which means different brand name or different models have their own standard. So this product cannot support all MP3 players.
- When connecting an MP3 player and there is a normal battery in the player (non rechargeable battery), you should remove the battery from the MP3 player and then connect it to the USB port. Otherwise, it may cause battery burst.
- When reading a USB device, be sure not to remove it from the USB port (change mode beforehand).

## SD/MMC Memory Card Operations

### Using the SD/MMC card:

This disc player features a SD/MMC memory card slot. When you insert a SD/MMC card into the memory card slot, the DVD player will read the SD/MMC card automatically. If you insert a USB stick into the USB port or a disc into the disc slot while reading the SD/MMC card, the unit will play the file in the USB or track on the disc. When you press the **MODE** button to switch back to SD/MMC reading mode. The operations of the SD/MMC memory card playback is the same with the CD / MP3 / WMA disc operations described above.

### Note:

- When reading the memory card, please don't touch or take out the card.
- If following the instruction above, the unit can't read the card, please check if the card is in good condition, or take out the card and then insert it into the card slot once more.

## AV In Operations

This car DVD player is equipped with an Audio / Video Auxiliary input jack on the front panel, so you can connect a video game, digital camera/camcorder or other device you wish to use in this car DVD player.

To connect a video device to the auxiliary A/V input jack, first connect it with the cable provided, Then press the **MODE** button to turn AV IN mode ON or OFF.

## Bluetooth Hands-free Function

When link up your mobile phone to this bluetooth hands-free system, you can dial or receive calls via this bluetooth device during driving.

You can also transmit the audio data(music) from a mobile phone to the DVD tuner via this bluetooth device.

Sound and picture will be automatically off when there is an in-coming call. Voice comes out from your car speakers and the built-in microphone receives your voice.

**You have to active automatic call reception so that the mobile phone accepts incoming calls automatically** (See the menu of the hands-free system). **In many countries, this is a prerequisite for legal operation of hands-free equipment while driving.**

### 1. Pairing

Before you use bluetooth free-hands system, between this bluetooth free-hands system and your bluetooth mobile phone must be connected with each other. This process is called "Pairing".

1. Turn your bluetooth mobile phone on and activate pairing mode. Now your bluetooth mobile phone searches for bluetooth devices in the reception range.

2. Once the bluetooth free-hands was found, please enter the pairing code "8888" to connect both devices with each other.

### 2. CONNECT

Press the **ST/LOC** button on the front panel or the **AUDIO** button on the remote control, the bluetooth module can connect with your mobile phone so long as you activate the bluetooth of the mobile phone. If connecting success, "CON OK", "CONNTEED" will be visible on the LCD display, and the "BT" will twinkle continuously on the LCD display.

Otherwise, it will appear "CONT FAIL", "NO CONT" on the LCD display. Meanwhile, the "BT" will not twinkle continuously on the LCD display.

### 3. DIAL CALL

3.1 Dial with the mobile phone directly.

3.2 Dial with the remote controller.

3.2.1 After connecting, press the "0~9", # or

\* push button on the remote control to enter telephone number .

- Pressing and holding the + button on the remote control when you want to input " + ".

- Simultaneously, the entered number will be appeared on the touch screen.

- If a number is wrongly input, press the **DEL** button on the remote control to delete the incorrect number.

3.2.2 Press the "☎" button on the head unit or remote control to dial.

### 4. Caller ID

When a ring comes, the caller's numbers will be shown on the touch screen, you can decide whether or not to answer, so you avoid unnecessary trouble and disturb.

### 5. Accepting an incoming call

If the automatic call accept function is not activated, when a ring comes, press the "☎" button on the head unit or remote control to switch on the calling.

### 6. Rejecting an incoming call

When a ring comes, press the "☎" button on the head unit or remote control to reject the coming call.

### 7. Terminating a call

During a phone call, press the "☎" button on the head unit or remote control to hang up the current call.

### 8. Call Transfer

During a phone call, you can transfer the call to your mobile phone or the hands-free system by pressing the "☎" button on the head unit or remote control.

### 9. BT MENU

At connect status, press the **BT MENU** button on the remote control to enter bluetooth menu. The structure of the bluetooth menu as follows:

**PRESET**(Preset phone number) :

List of saved phone number, you can save 6 phone numbers total.

**RECEIVE**(Received phone number):

List of the latest 6 received calls.

**DIALED**(Dialed phone number):

List of the latest 6 outgoing calls.

**MISSED**(Missed phone number):

List of the latest 6 Missed calls.

**AUTO ON/OFF**: Switch auto answer or

manual answer.

**DEFAULT:** Restore to the default setup.

Use ▲/▼ cursor button to select the item. Press the **ENTER** to enter the current menu item. Press the **ZOOM** button to exit from current menu. Press the **BT MENU** button exit bluetooth menu.

#### a) Select preset number list:

You can select the next or prev phone number that stored on preset number list by pressing the ▲/▼ button.

#### b) Edit preset number list:

When you access the preset phone number list. You can see **NO NUMBER**(1-6) on the LCD display if you haven't stored any phone number. Then press **ENTER** again to enter editing status.

- Press the "0~9", # or \* push button on the remote control, Or click the numerical buttons "0~9", # or \* on the touch screen to enter telephone number .

- Pressing and holding the + button on the remote control, when you want to input " + " .

- Simultaneously, the entered number will be appeared on the LCD display.

If a number is wrongly input, press the **DEL** button on the remote control to delete the incorrect number.

After the entire phone number has been input, press the **ZOOM** to save the phone number. Press **ZOOM** again to exit from phone editing status.

**Note:** If a new phone number is saved, the old number is deleted.

#### c) Dialling from the phone number memory

When you look around the preset phone number or received list or dialed list or missed list, you can dial any phone number on the lists by pressing "  " button without entering the phone number again.

#### d) Switch auto or manual answer

Select auto answer or manual answer the coming phone by rotating the volume knob or pressing **VOL+/VOL-** button after enter this preset item.

### 10. Voice dialing function

If your mobile phone supports this function,

you can also use this function with the hands-free system.





**Note:**To operate this function according to the instruction manual of your mobile phone.

### 11. A2DP Function

If your mobile phone support **A2DP** function ( Advance Audio Distribution Profile) that it is special designed for transmitting stereo music to bluetooth device.

You can transmit the audio data(music) from a mobile phone to the DVD tuner via this bluetooth device. You can listen to the music stored in your mobile phone by the bluetooth hands-free system.

- Make sure that your mobile phone and this DVD tuner were connected via pairing.

The  (Pause/play),  (Stop),  (Previous Track),  (Next Track) on the remote control are available in A2DP playback status.

Press the **MODE** button on the head unit or remote control to switch to other mode.

### **WARNING:**

1. Please be sure that the distance between your mobile phone and car audio is less than 3 meters.

2. This device must accept any interference received, including interference that may cause undesired operation.

## Setup

In DVD mode, when the disc is playing or in stop mode, press the **SETUP** button to enter the setup menu.

1. When the **SYSTEM SETUP** icon in the upper part of the menu is highlighted, use the ◀/▶ button to move between the different setting pages.

2. Press the ▼ button to move the cursor to the list of options below. Then you can use the ▲/▼ button to move between the different setup options

3. Press the ▶ or **ENTER** button to move to list of setup options, and the use ▲/▼ button and **ENTER** button to adjust your selection.

4. When the setting is finished, press the **SETUP** button to return to normal mode.

**NOTE:** When settings are changed, the old settings are overwritten. Make note of the current settings before making changes. If the vehicle's battery is disconnected, the settings will be cleared and will return to the factory settings when power is next applied.

### System Setup

When you first open the setup menu, you will see the System Setup page:

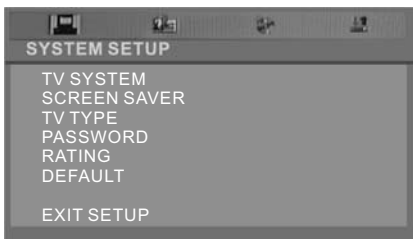

#### 1) TV SYSTEM

TV SYSTEM is used to select the TV output mode. This player can play discs recorded in either PAL or NTSC formats.

- Select NTSC format when the unit is connected to an NTSC TV.
- Select PAL format when the unit is connected to a PAL TV.
- You can also choose AUTO SELECT,

which will sense the type of monitor attached to the output and select NTSC or PAL as need. If you know the type of monitor, you should choose the type in this menu rather than letting AUTO select do it for you. This is because there may be an small undesirable delay and flickering of the screen during the AUTO select process.

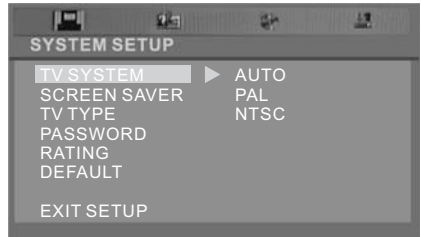

#### 2) SCREEN SAVER

Like a computer monitor, video screens can “burn in” if a still image is displayed too long on the screen.

This unit features a “screen saver” which produces a moving image to avoid burn-in, if SCREEN SAVER is enabled in the Setup menu.

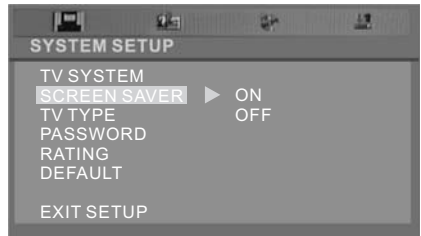

#### 3) SETTING the TV TYPE

TV types can vary based on their aspect ratio. The common monitors fall into one of three categories: 4:3 (PS/Pan and Scan), 4:3 (LB/ Letterbox) or 16:9 (Widescreen).

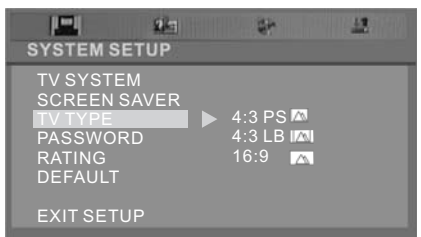

Playing a video recorded in one aspect ratio on a monitor with a different ratio can result in some mismatches and undesirable display distortion or cutoffs.

Picture Format on Disc	TV Screen Size		
	4:3	4:3	16:9
4:3	Pan Scan	Letter-box	Wide Screen
16:9			

Read the following to assist you in setting up the TV type:

#### 4:3 PS (PAN SCAN)

Select this when connected to a conventional 4:3 size monitor. The picture will fill the entire TV screen. However, due to the mismatch in aspect ratio, parts of the movie at the extreme left and right sides will not be visible when playing a 16:9 format movie.



#### 4:3 LB (LETTER BOX)

When you are playing a widescreen format video on a normal (4:3) monitor, the best way to view this is in (4:3) letterbox format. You can see the full picture, but there will be a black band at the top and bottom of the screen.



#### 16:9 (WIDESCREEN)

Select this format when connected to a widescreen TV.



#### 4) PASSWORD

The password system is used in conjunction with the Parental Controls settings to prevent a young person from changing the settings without permission. The factory default password is "0000". If you wish to change it, enter "0000" and when prompted, enter a different 4-digit number.

#### 5) PARENTAL CONTROL LEVEL

Use this function to restrict the viewing of movies to children of appropriate age levels.

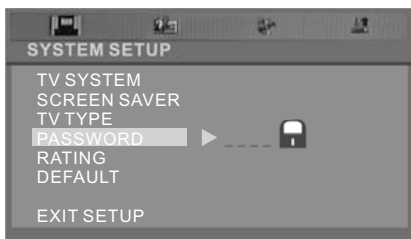

1. Press the **▲/▼** button to select "PASSWORD" then press the **ENTER** button.
2. The password input mode is now activated. Use the on the remote control to input the 4-digit password, then press the **ENTER** button. (The factory default password is "0000")
3. Press the **▲/▼** button to select "RATING" then press the **ENTER** button. The restriction levels (parental levels) appear on the right.
4. Press the **▲/▼** button to select the restriction level (1 to 8) and then press the **ENTER** button.
5. When the setting is finished, press the **SETUP** button to return to normal mode.

#### 6) DEFAULT

Select DEFAULT and confirm it to restore all the System Settings to those programmed at the factory, except the Parental Controls and Password.



## Language Setup

When you open the language setup page, you will see the following screen:



This menu provides many choices for the menu, DVD and subtitle languages. The languages for the DVD player in its various menus are set in different menus than those choices you might make for the playback of a particular disc. Please note that language options vary from disc to disc, and some settings may be unavailable on some discs.

### OSD LANGUAGE:

ENGLISH/GERMAN/SPANISH/FRENCH/P  
ORTUGUESE/ITALIAN/RUSSIAN/POLISH

### AUDIO LANG:

ENGLISH/GERMAN/SPANISH/FRENCH/P  
ORTUGUESE/ITALIAN/RUSSIAN/POLISH

### SUBTITLE LANG:

ENGLISH/GERMAN/SPANISH/FRENCH/P  
ORTUGUESE/ITALIAN/RUSSIAN/POLISH

### MENU LANG:

ENGLISH/GERMAN/SPANISH/FRENCH/P  
ORTUGUESE/ITALIAN/RUSSIAN/POLISH

## Audio Setup

When you open the AUDIO menu, you will see the following screen:



1. AUDIO OUT: Change among SPDIF/OFF, SPDIF/RAW and SPDIF/PCM.

2. KEY: Change among b, -4, -2, 0, +2, +4, #.

## Digital Setup

When you open the DIGITAL SETUP menu, you will see the DIGITAL SETUP screen:

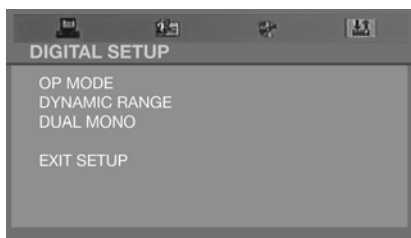

1) OP MODE: Change among LINE OUT/RF REMOD.

- LINE OUT: LINE OUT mode, with digital dialog normalization.

- RF REMOD: RF REMODULATION mode, with heavy compression and digital dialog normalization.

2) DYNAMIC RANGE: Change among FULL, 6/8, 4/8, 2/8, OFF.

3) DUAL MONO: Change among STEREO, MONO L, MONO R, MIX MONO.

### About Parental Controls

Commercially-recorded DVD discs have parental level assignments. The range of parental controls is from 1 to 8. In general, this range corresponds to established movie rating systems. Movie rating systems may vary depending on the country in which you live. At the bottom of this page is a chart showing the rating system and corresponding Parental Control ratings for the USA.

The player can be set in a similar way. If the player's parental level is set to 8 it will play all discs. If the player's parental level is set below 8, only discs with a lower or equal parental level will play.

For example, if the player is set to 5, only discs with parental control ratings of 1-5 will play. To play a disc with a higher number rating, you must change the player's rating to a higher number.

Consider a disc that is suitable for most audiences, and is rated as level 2 for the most part. However in the middle there are also scenes rated at 5 and 7 (not suitable for children). Alternative scenes with lower rating are included. The player plays the highest rated scene that the parental setting allows.

A section of the disc can have several different sequences that vary in parental control level. In the above example of a disc with parental control, the player will show a different section depending on the parental control level set in the player's menu.

In this way parents can control the content of films and there is no indication that any censorship has occurred.

	Unlock		Unlock
1	KID SAFE	5	PG-R
2	G	6	R
3	PG	7	NC-17
4	PG 13	8	ADULT

### Playing MP3 discs

#### What is MP3?

MP3 (MPEG-1 Audio Layer 3) is a compression standard prescribed by the ISO, the International Standardization Organization and MPEG, which is a joint activity institution of the IEC.

MP3 files contain compressed audio data. MP3 encoding is capable of compressing audio data at extremely high ratios, reducing the size of music files to as much as one-tenth their original size. This is achieved while still maintaining near-CD quality. The MP3 format realizes such high compression ratios by eliminating the sounds that are either inaudible to the human ear or masked by other sounds.

#### Corresponding file systems

This device supports discs formatted with ISO9660 level 1 or level 2. Under the ISO9660 standard, there are some restrictions to remember.

The maximum nested folder depth is 8 (including the root directory). The number of characters for a folder/file names are letters A-Z (all caps), numbers 0-9, and '\_' (underscore).

This device also can play back discs in Joliet, Romeo, etc., and other standards that conform to ISO9660. However, sometimes the file names, folder names, etc., are not displayed correctly.

#### Playing a JPEG disc

When preparing a disc of jpeg images to be shown using the DVD player, please note that following guidelines:

- The recommended image size is 640 x 480 pixels. If a file is recorded at a higher resolution, the player must resample it, which will cause delays in displaying the image.
- Only "baseline" type JPEG images can be displayed on this player. This is the typical format used in digital cameras and web cameras.

“Progressive” (typically used for website display) or “lossless” (an older format which is rarely used today) JPEG files cannot be played. So be sure you are saving the files in the proper format. If you play a progressive or lossless JPEG image, a black screen will appear. When you next select a baseline image, you may experience some delays.

### Playing MPEG discs

- This unit can play back MPEG 1 or 2 files with the extension code <.mpg>.
- Audio stream should conform to MPEG1 Audio Layer 2.

### Frequently Asked Questions

**Q: I inserted a DVD disc, but it cannot be played. The message “REGION ERROR” is displayed.**

**A:** DVD players and discs all have “REGION CODES.” If the region code number on the DVD disc does not correspond to the region number of this DVD player, the unit cannot play the disc.

**Q: When I insert a DVD disc, there is a window shown on the screen for me to enter a 4 character password. Why?**

**A:** The current disc has a “Parental Control” level, and the player’s parental level is set below the level of the disc. To view this disc, you should enter the correct password to play the disc normally.

## Troubleshooting

If it appears that your DVD unit is faulty, please first consult this checklist. It may be that something simple has been overlooked.

Under no circumstances should you try to repair the player yourself, as this will void the warranty. Only qualified service personnel may remove the cover or service this player.

### No Power

- ◆ If the power supply is connected to the car accessory circuits, but the engine is not turned on, switch the ignition key to “ACC.”
- ◆ Check if the fuse is blown. Replace with a new fuse if necessary.
- ◆ Check if the POWER button on the front of the player is set to ON.

### No Picture

- ◆ Check if the monitor or TV is switched ON.
- ◆ Check if select proper mode has been selected (such as Disc Play mode or AV mode).
- ◆ Check the video connections.
- Distorted Picture
- ◆ Check the disc for fingerprints and clean it with soft cloth, wiping from center to the edge.
- ◆ Sometimes a small amount of picture distortion may be present. This is not a malfunction.

### Completely Distorted Picture

- ◆ The disc format is not the same as the TV-set used (PAL/NTSC). Select the proper setting in the TV SYSTEM menu.

### No Color in Picture

- ◆ The disc format is not the same as the TV-set used (PAL/NTSC). Select the proper setting in the TV SYSTEM menu (see page 21).

### Disc Does Not Play

- ◆ Be sure that the disc label faces up.
- ◆ Clean the disc.
- ◆ Check if the disc is defective by trying another disc.

### **No Sound**

- ◆ Check the audio connections.

### **The Player Does Not Respond to the Remote Control**

- ◆ Aim the remote control directly at the sensor on the front of the player.
- ◆ Remove any obstacles which may interfere with the signal path.
- ◆ Inspect or replace the remote control battery.

### **Picture is distorted or Only Black and White**

- ◆ The disc format is not according to the TV-set used (PAL/NTSC). Select the proper setting in the TV SYSTEM menu.

### **No Audio at Digital Output**

- ◆ Check the digital connections.
- ◆ Check the Digital Audio menu to make sure that the digital output is correctly set.
  - ◆ Check if the audio format of the selected audio language matches your receiver's capabilities.

### **Buttons Do Not Work**

- ◆ Press Reset button on the front panel of the DVD unit.

## **Specifications**

### **GENERAL**

Power Supply Requirements  
DC 12 Volts, Negative Ground

Chassis Dimensions  
178(W)x160(D)x 50(H) mm

Tone Controls  
- Bass (at 100 Hz) ±10 dB  
- Treble (at 10 KHz) ±10 dB

Maximum Output Power: 4x75watts

Current Drain: 15 Ampere (max.)

### **DVD PLAYER**

Signal to Noise Ratio: > 50 dB

Channel Separation: > 40 dB

Frequency Response: 20Hz - 20 KHz

Discs/files played: DVD,VCD,SVCD,CD-DA,CD-R/RW/MPEG4/MP3/WMA

### **MONITOR SCREEN**

Screen: 3 inch wide liquid crystal panel

Number of pixels: 16,777,216 pixels

Number of dots: 959(w)X240(h) pixels

### **RADIO**

#### **FM**

Frequency Coverage: 87.5 - 108 MHz

IF: 10.7 MHz

Sensitivity (S/N=30dB): 4µV

Stereo Separation: >25dB

### **USB/SD/MMC CARD**

USB Port type: 2.0

USB Port Maximum Handling Capacity: 2GB

SD/MMC Card Slot Maximum Handling Capacity: 2 GB