



MICRO COMPONENT  
AUDIO SYSTEM  
**MP3-CD/CD-R/RW PLAYBACK**  
MM-ZS8

Instruction Manual



## Safety Warnings



GB

**CLASS 1 LASER PRODUCT  
KLASSE 1 LASER PRODUKT  
LUOKAN 1 LASER LAITE  
KLASS 1 LASER APPARAT  
PRODUCTO LASER CLASE 1**

### CLASS 1 LASER PRODUCT

This Compact Disc player is classified as a CLASS 1 LASER product.

Use of controls adjustments or performance of procedures other than those specified herein may result in hazardous radiation exposure.

 **CAUTION**   
RISK OF ELECTRIC SHOCK.  
DO NOT OPEN

**CAUTION:**  
TO REDUCE THE RISK OF ELECTRIC SHOCK,  
DO NOT REMOVE REAR COVER, NO USER  
SERVICEABLE PARTS INSIDE, REFER SER-  
VICING TO QUALIFIED SERVICE  
PERSONNEL.

### CAUTION-INVISIBLE LASER RADIATION WHEN OPEN AND INTER LOCKS DEFEATED, AVOID EXPOSURE TO BEAM.

WARNING: TO REDUCE THE RISK OF FIRE OR ELECTRIC SHOCK, DO NOT EXPOSE THIS APPLIANCE TO RAIN OR MOISTURE.

CAUTION: TO PREVENT ELECTRIC SHOCK, MATCH WIDE BLADE OF PLUG TO WIDE SLOT, FULLY INSERT.



This symbol indicates that dangerous voltage constituting of a risk of electric shock is present within this unit.



This symbol indicates that there are important operating and maintenance instructions in the owners manual accompanying this unit.

## Wiring the Mains Power Supply Plug(UK Only)

### IMPORTANT NOTICE

The mains lead on this equipment is supplied with a moulded plug incorporating a fuse. The value of the fuse is indicated on the pin face of the plug and, if it requires replacing, a fuse approved to BS1362 of the same rating must be used.

Never use the plug with the fuse cover omitted. If the cover is detachable. If a replacement fuse cover is required, it must be of the same colour as the pin face of the plug. Replacement covers are available from your dealer.

If the fitted plug is not suitable for the power points in your house or the cable is not long enough to reach a power point, you should obtain a suitable safety approved extension lead or consult your dealer for assistance.

However, if there is no alternative to cutting off the plug, remove the fuse and then safely dispose of the plug. Do NOT connect the plug to a mains socket as there is a risk of shock hazard from the bared flexible cord.

### IMPORTANT

The wires in the mains lead are coloured in accordance with the following code:-

**BLUE = NEUTRAL      BROWN = LIVE**

As these colours may not correspond to the coloured markings identifying the terminals in your plug, proceed as follows:-

The wire coloured BLUE must be connected to the terminal marked with the letter N or coloured BLUE or BLACK. The wire coloured BROWN must be connected to the terminal marked with the letter L or coloured BROWN or RED.

**WARNING:** DO NOT CONNECT EITHER WIRE TO THE EARTH TERMINAL WHICH IS MARKED WITH THE LETTER E OR BY THE EARTH SYMBOL  , OR COLOURED GREEN OR GREEN AND YELLOW.

# Contents

Thank you for buying this  
SAMSUNG micro component system.

Please take time to read these instructions.  
They will allow you to operate your  
system with ease and take full advantage  
of its features.



◆ SAFETY WARNINGS .....	2
◆ INSTALLING YOUR MICRO COMPONENT SYSTEM	
■ Front Panel View .....	4
■ Remote Control .....	5
■ Rear Panel View .....	6
■ Where to Install Your Micro Component System .....	7
■ Connecting your System to the Power Supply .....	7
■ Inserting Remote Control Batteries .....	7
■ Connecting to an External Source .....	8
■ CD Digital Out Jack .....	8
■ Speaker Connection .....	8
■ Connecting the AM (MW)/LW Aerial .....	9
■ Connecting the FM Aerial .....	9
■ DEMO Function .....	10
■ DIMMER Function .....	10
■ Setting the Clock .....	10
◆ MP3-CD/CD-PLAYER	
■ To replay the CD/MP3-CD .....	11
■ Selecting a Track .....	11
■ To select the MP3-CD album and track .....	11
■ Searching for a Specific Music Passage on a CD .....	12
■ Function to skip through 10 tracks at a time .....	13
■ Repeating One or All Tracks on the Compact Discs .....	13
■ REPEAT A→B Function .....	13
■ Resume Function .....	13
■ Programming the Order of Playback .....	14
■ Checking or Changing Programmed Tracks .....	14
◆ TUNER	
■ Searching for and Storing the Radio Stations .....	15
■ Selecting a Stored Station .....	15
■ Improving Radio Reception .....	15
■ About RDS broadcasting .....	16
■ About RDS DISPLAY function .....	16
■ PTY(Program Type) indication and PTY-SEARCH function .....	17
◆ TAPE DECK	
■ Listening to a Cassette .....	18
■ Selecting the Cassette Playback Mode .....	18
■ Recording a Compact Disc .....	19
■ Recording a Radio Program .....	19
◆ OTHER FUNCTIONS	
■ Timer Function .....	20
■ Canceling the Timer .....	20
■ EQ/S BASS Function .....	21
■ SRS WOW Function .....	21
■ MUTE Function .....	22
■ Setting the System to Switch off Automatically .....	22
■ Connecting Headphones .....	22
◆ RECOMMENDATIONS FOR USE	
■ Safety Precautions .....	23
■ Cleaning Your Micro Component System .....	23
■ Precautions When Using Compact Discs .....	24
■ Precautions When Using Audio Cassettes .....	24
■ Before Contacting the After-Sales Service .....	24
■ Technical Specifications .....	25

## Symbols



Press



Push



Important



Note

## Front Panel View

GB

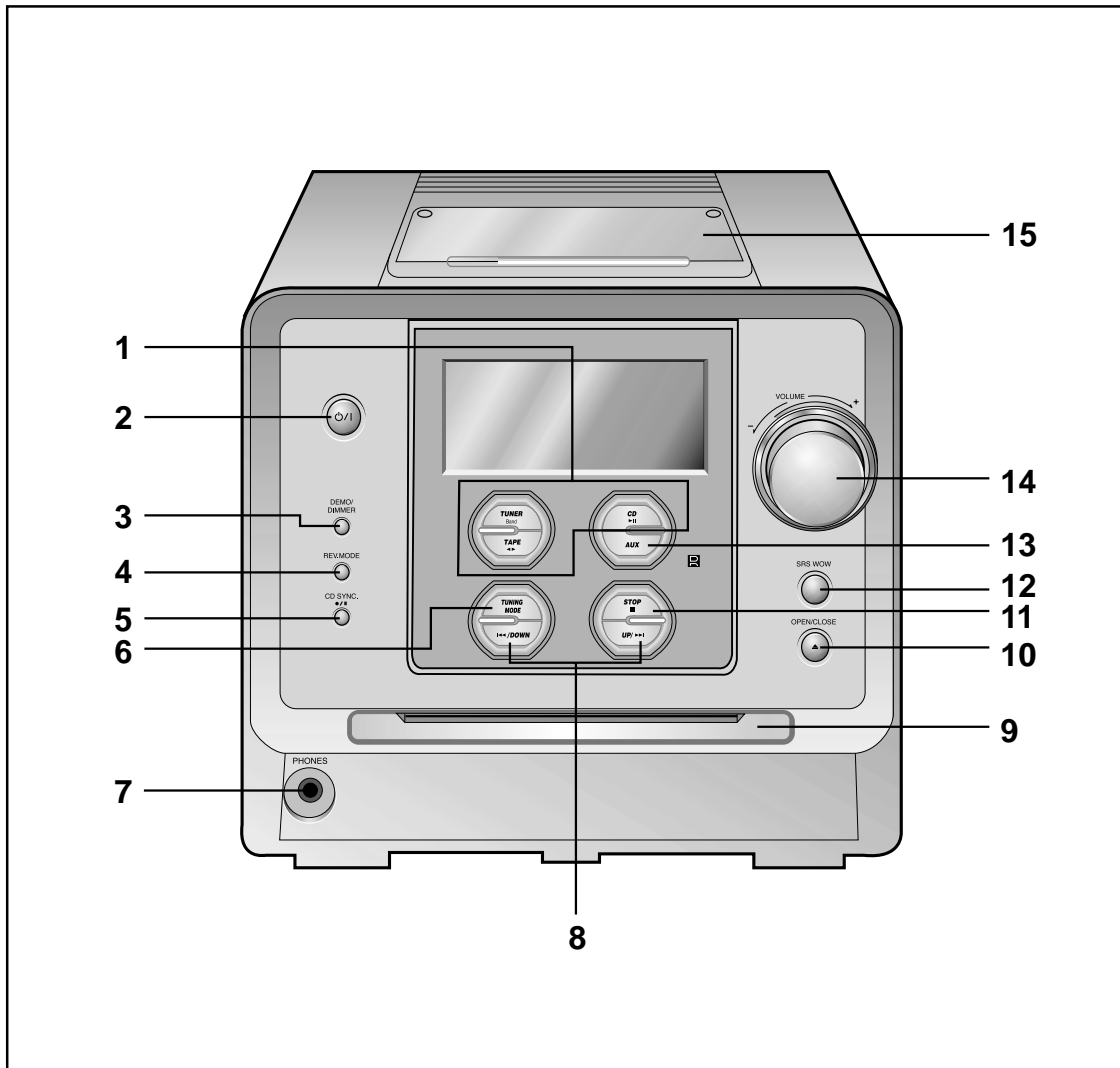

- |                               |   |
|-------------------------------|---|
| 1. Function (TUNER/CD/TAPE)   | 9. Disc Tray                              |
| 2. POWER                      | 10. CD Door OPEN/CLOSE                    |
| 3. DEMO/DIMMER                | 11. STOP                                  |
| 4. REV.MODE                   | 12. SRS WOW                               |
| 5. CD SYNCHRONISE / REC/PAUSE | 13. AUX                                   |
| 6. TUNING MODE                | 14. VOLUME                                |
| 7. Headphone Jack Connector   | 15. PUSH EJECT (Cassette Door OPEN/CLOSE) |
| 8. Skip or Search             |   |

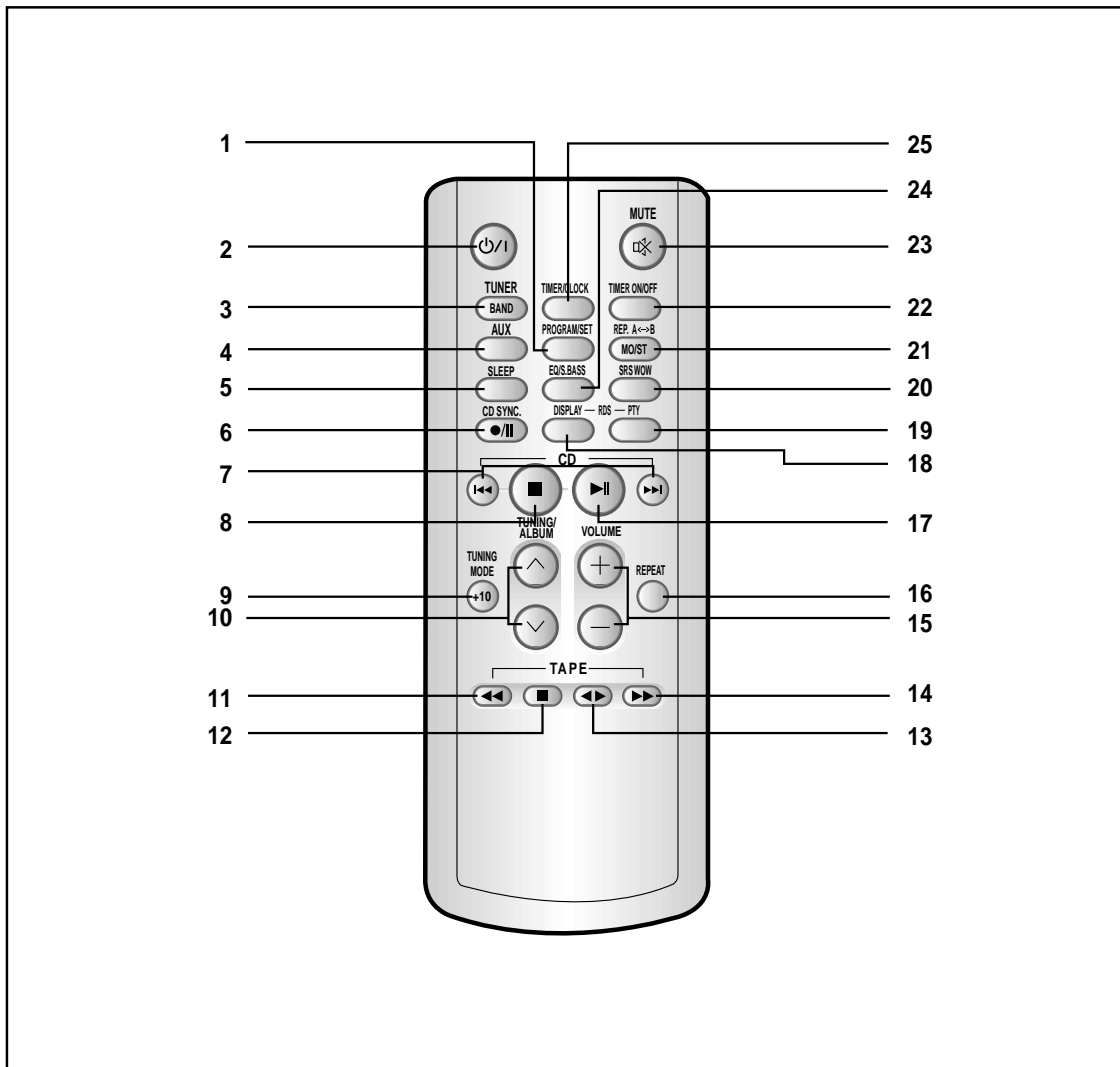

- |                                    |                                 |
|------------------------------------|---------------------------------|
| 1. PROGRAM/SET                     | 14. Tape Fast-Forward           |
| 2. POWER                           | 15. VOLUME Control              |
| 3. TUNER/BAND                      | 16. REPEAT                      |
| 4. AUX                             | 17. CD Play/Pause               |
| 5. SLEEP                           | 18. Display (RDS)               |
| 6. CD SYNCHRONISE / REC/PAUSE      | 19. PTY (RDS)                   |
| 7. CD SKIP or SEARCH               | 20. SRS WOW                     |
| 8. CD Stop                         | 21. REPEAT A↔B / FM Mono/Stereo |
| 9. TUNING MODE/+10                 | 22. TIMER ON/OFF                |
| 10. Tuning Up or Down / ALBUM SKIP | 23. MUTE                        |
| 11. Tape Rewind                    | 24. EQ/Super BASS               |
| 12. Deck Stop                      | 25. TIMER/CLOCK                 |

## Rear Panel View

GB

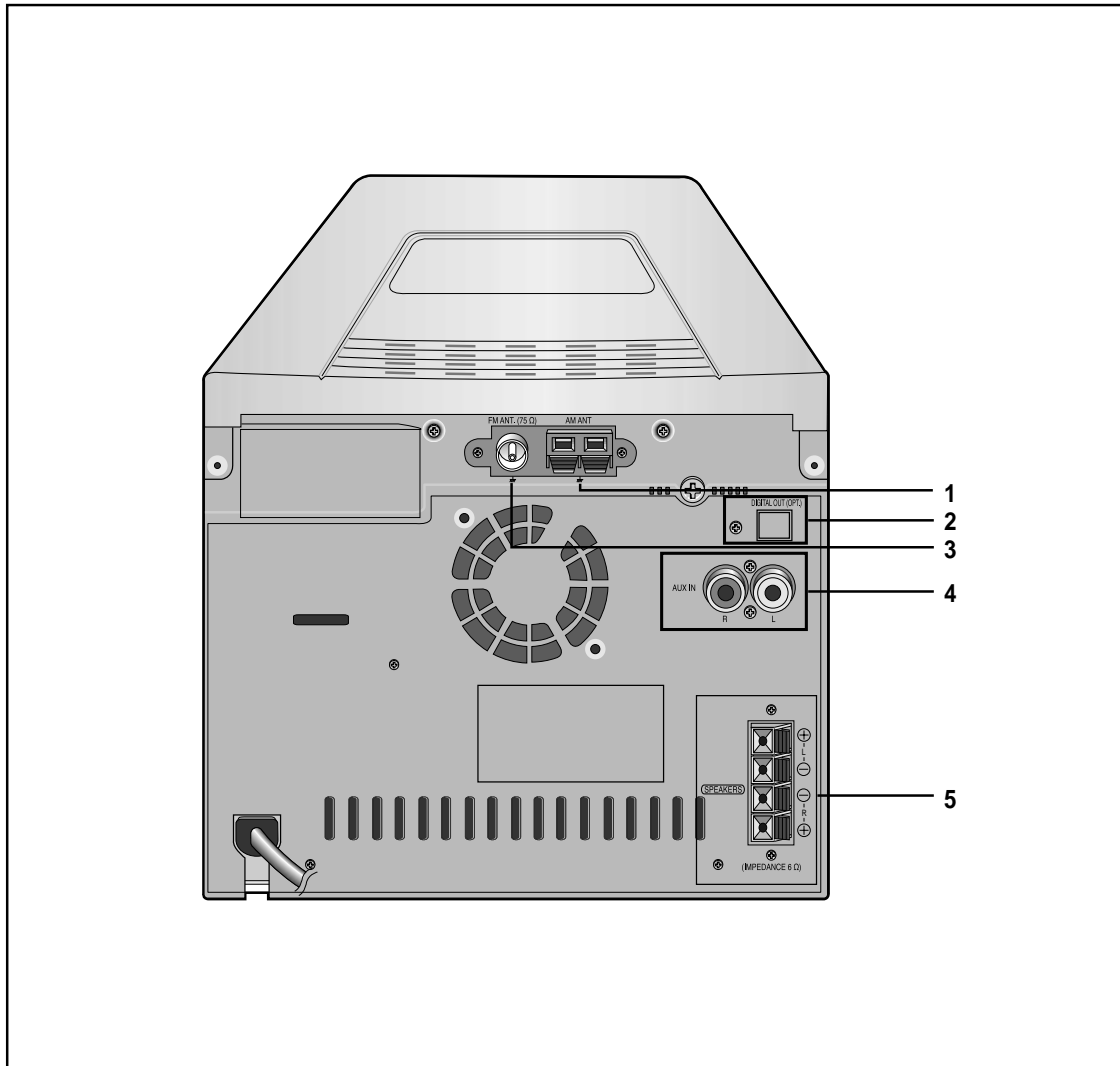

1. AM Aerial Connector Terminal
2. CD Digital Out jack
3. FM Aerial Connector Terminal
4. AUX-Input
5. Loudspeaker Connector Terminals

## Where to Install Your Micro Component System

To take full advantage of your new micro component system, follow these installation instructions before connecting the unit.

- ◆ Install the system on a flat, stable surface.
- ◆ Never place this unit on carpeting.
- ◆ Never place this unit in an outdoor area.
- ◆ Maintain an open space of approximately 6 inches (15 cm) on the sides and rear of the system, for ventilation purposes.
- ◆ Make sure that you have enough room to open the compact disc compartment easily.
- ◆ Place the loudspeakers at a reasonable distance on either side of the system to ensure good stereo sound.
- ◆ Direct the loudspeakers towards the listening area.
- ◆ For optimum performance, make sure that both speakers are placed at an equal distance above the floor.



## Connecting your System to the Power Supply

The main lead must be plugged into an appropriate socket.

- ☛ Before plugging your system into a main socket, you must check the voltage.

- 1 Plug the main lead (marked **AC Cord** on the rear of the system) into an appropriate socket.
- 2 Press the (⏻ / I) button to switch your micro component system on.

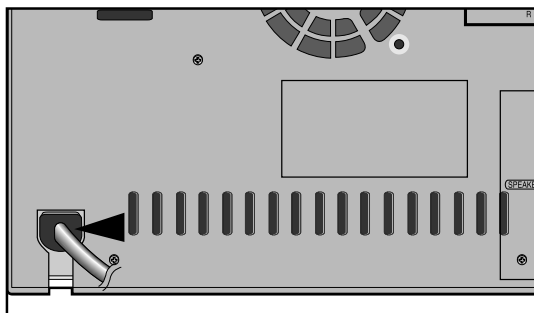

## Inserting Remote Control Batteries

GB

Insert or replace remote control batteries when you:

- ◆ Purchase the micro component system
  - ◆ Find that the remote control is no longer operating correctly
- ☛ When replacing the batteries, use a new set of batteries and never mix alkaline and manganese batteries.

- 1 Place your thumb on the position marked  on the battery compartment cover (rear of the remote control) and push the cover in the direction of the arrow.
- 2 Insert two AAA, LR03 or equivalent batteries, taking care to respect the polarities:
  - ◆ + on the battery against + in the battery compartment
  - ◆ - on the battery against - in the battery compartment
- 3 Replace the cover by sliding it back until it clicks into position.

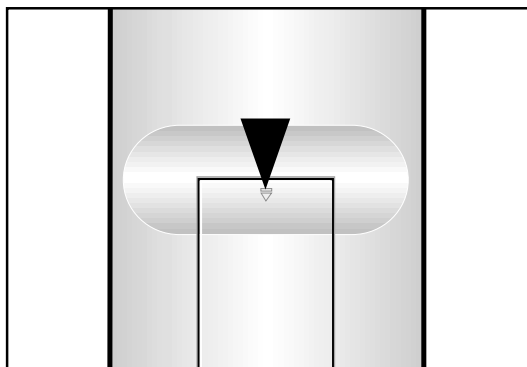

## Connecting to an External Source

The auxiliary input can be used to take advantage of the sound quality of your micro component system when listening to other sources.

- Examples:**
- ◆ A television
  - ◆ A video disc player
  - ◆ A HI-FI stereo video cassette recorder

➤ To connect the external source, the source must have an audio output. In addition, you need an RCA connection cable.

- 1 Set the system to standby mode and disconnect it and the external source from the main.
- 2 Connect the audio cable to the rear of the micro component system.
 

Connect the...	To the connector marked...
Red jack	R (right)
White jack	L (left)

➤ For optimum sound quality, do not invert the right and left channels.
- 3 Plug the system back into the main socket and press (⏻/I) to switch it on.
- 4 Select the AUX source by pressing **AUX**.  
**Result:** **AUX** is displayed.
- 5 Switch the external source on.

**Example:** You can watch a film and take advantage of stereo sound provided that the original sound track is in stereo (as if you were in a cinema).

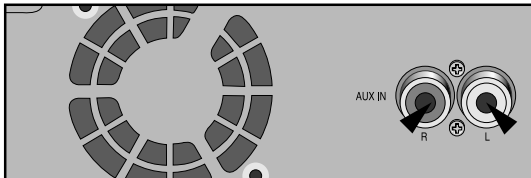

## CD Digital Out Jack

This unit can output CD digital sound signals through this jack. Use an optical cable to connect digital audio equipment. (DAT deck, MD recorder, etc.). Remove the dust cap (1) from the CD DIGITAL OUT jack. Then, connect an optical cable plug to the CD DIGITAL OUT jack.

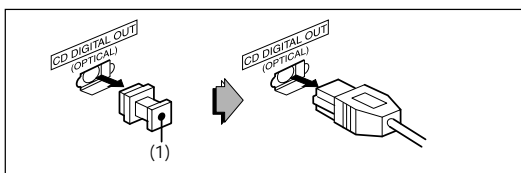

**When the CD DIGITAL OUT jack is not being used.**  
Attach the supplied dust cap.

## Speaker Connection

**Main Speaker Connection:** Connect the Speaker cords (red/black) to the Main Speaker jacks of System.

- ◆ Red wire to the + terminals
- ◆ Black wire to the - terminals

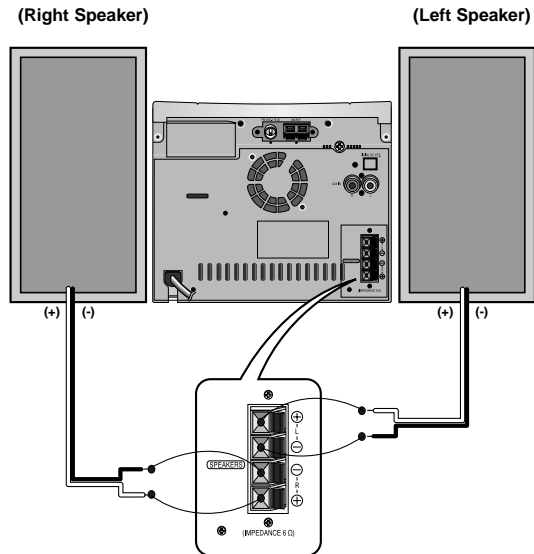

## Directions in Installing Speaker

- ◆ Installation in a place near heating apparatus, under direct lay of light or with high humidity may cause performance degradation of the speaker.
- ◆ Do not install on the wall or on a high place of pole or other unstable place to prevent any safety accident caused by falling of the speaker.
- ◆ Do not take the speaker apart from TV or computer monitor. The speaker near the TV or computer monitor may influence the quality of the screen display.



## Connecting the AM (MW)/LW Aerial

GB

The AM aerial (for long and medium waves) can be:

- ◆ Placed on a stable surface
- ◆ Fixed to the wall (you must first remove the base)

The **AM** aerial connector terminals are located on the rear of the system and are marked **AM ANT.**

- ☛ To avoid noise interference, check that the loudspeaker wires do not run close to the aerial wires. Always keep them at least 2 inches (5 cm) away.

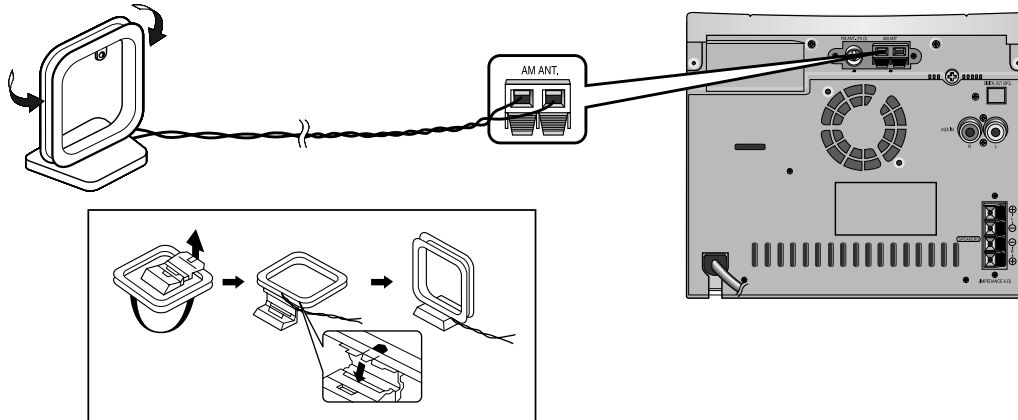

## Connecting the FM Aerial

How to connect a COAXIAL TYPE aerial.

- ◆ Connect a 75Ω antenna to the **FM** antenna terminal.
- ◆ Plug the connector on the **FM** aerial supplied into the coaxial socket (75Ω) marked **FM** on the rear of the system.
- ◆ Follow the instructions given on Page 15 to tune into a radio station, and determine the best position for the aerial.
- ◆ If reception is poor, you may need to install an outdoor aerial. To do so, connect an outdoor **FM** aerial to the **FM** socket on the rear of the system using a 75Ω coaxial cable (not supplied).

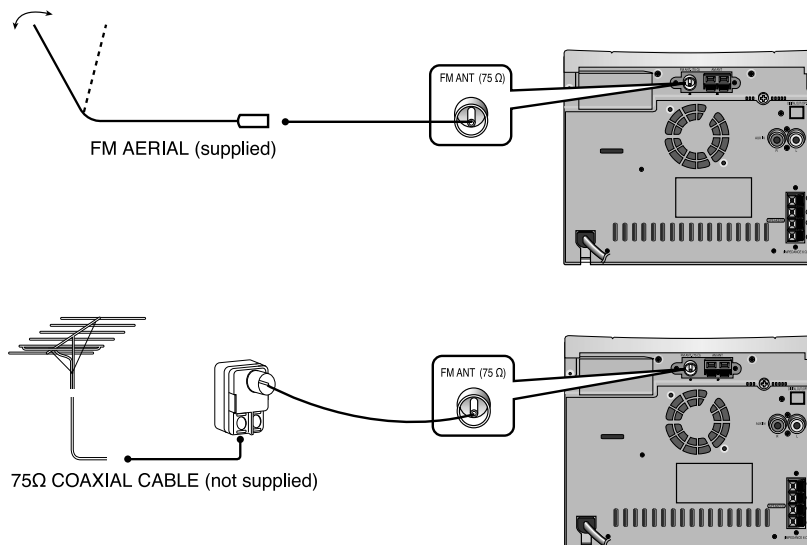

## DEMO Function

GB

You can view the various functions available on your system.

- 1 Press and hold **DEMO/DIMMER** button.  
Result: The various functions available are listed in turn on the display.

➤ All these functions are described in detail in this booklet. For instructions on how to use them, refer to the appropriate sections.

- 2 To cancel this function, press **DEMO/DIMMER** again.



## DIMMER Function

You can adjust the brightness of the LCD display depending on the surrounding lighting conditions.

- 1 Press the **DEMO/DIMMER** button.  
◆ Your selection switches each time the button is pressed:  
**DIMMER ON(Dim) → DIMMER OFF(Bright).**



## Setting the Clock

Your system is equipped with a clock which allows you to turn your system on and off automatically.

You should set the clock:

- ◆ When you first purchase the micro component system
  - ◆ After a power failure
  - ◆ After unplugging the unit
- ☛ ◆ For each step, you have a few seconds to set the required options. If you exceed this time, you must start again.

- 1 Switch the system on by pressing (⏻/|).
- 2 Press **TIMER/CLOCK** twice.  
Result: **CLOCK** is displayed.
- 3 Press **PROGRAM/SET**.  
Result: The hour flashes.
- 4 

To...	Press...
Increase the hours .....	▶▶
Decrease the hours .....	◀◀
- 5 When the correct hour is displayed, press **PROGRAM/SET**.  
Result: The minutes flash.
- 6 

To...	Press...
Increase the minutes .....	▶▶
Decrease the minutes .....	◀◀
- 7 When the correct time is displayed, press **PROGRAM/SET**.  
Result: ◆ "TIMER" appears in the display.  
◆ The current time is now set.

- ◆ You can display the time, even when you are using another function, by pressing **TIMER/CLOCK** once.

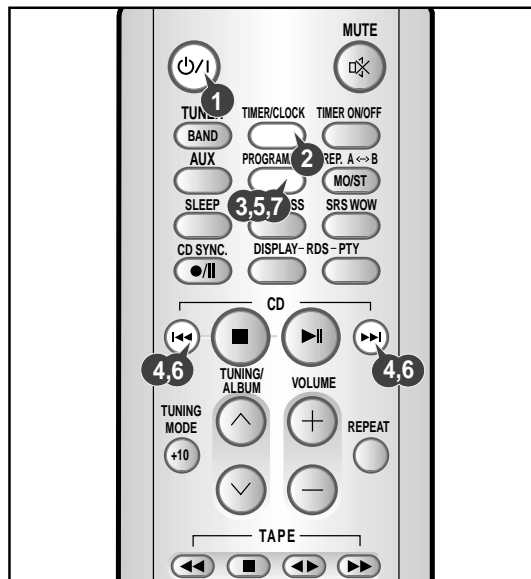

## To replay the CD/MP3-CD

You can play 12 cm or 8 cm compact discs without an adapter.

This unit has been designed to playback the CDs: Audio CD, CD Text, CD-R, CD-RW and MP3-CD.

Continued use of irregular shape CDs (heart-shape, octagonal, etc.) can damage the unit.

- 1 Select the CD function by pressing **CD (▶||)** button.
- 2 Press the **Open/Close (▲)** button.  
**Result:** The compartment opens.
- 3 Place your disc in the compartment, with the label on the disc facing upwards.
- 4 Close the compartment by pressing the **Open/Close (▲)** button again.
- 5 Press the **CD (▶||)** button.
  - ◆ Your CD Player will take a few moments to scan through all the tracks recorded on a particular MP3-CD
  - ◆ The English name of the song may be indicated on the display only if directly downloaded from the PC or if the purchased MP3-CD is sorted according to titles(directory). (Other languages besides English may not be indicated.)
  - ◆ The English name of the track may not be indicated depending on the characteristics of the MP3-CD.
- 6 To stop playback temporarily, press the **CD (▶||)** button.
  - Press **CD (▶||)** again to continue playing the disc.
- 7 Press the **STOP (■)** button when you have finished.

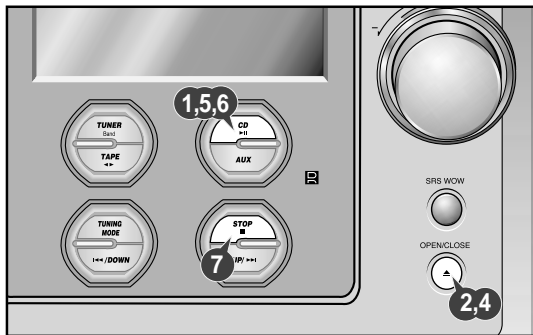

## Selecting a Track

You can select the track you wish to listen to, either when the compact disc player is stopped or when a disc is playing.

To start playback at the beginning of the...	Press...
Next track .....	▶▶ once
Current track .....	◀◀ once
Previous track .....	◀◀ twice
Track of your choice .....	◀◀ or ▶▶ the appropriate number of times.

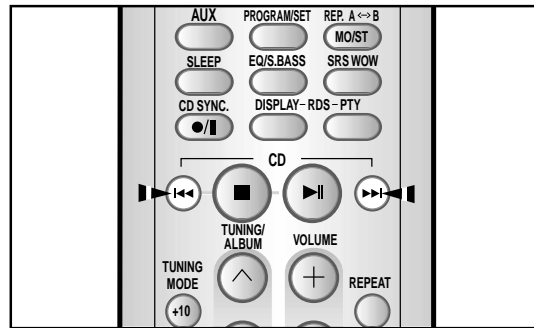

## To select the MP3-CD album and track

The album and track of the MP3-CD desired to listen may be selected on stopping or during playbacks.

- 1 To move the album, press the **TUNING/ALBUM ^ / v** button.
  - ◆ Moves the track within the album.
  - ◆ If the ◀◀, ▶▶ button is pressed more than the number of tracks within the album, it moves to the next album.

➤ This function works only with remote control.

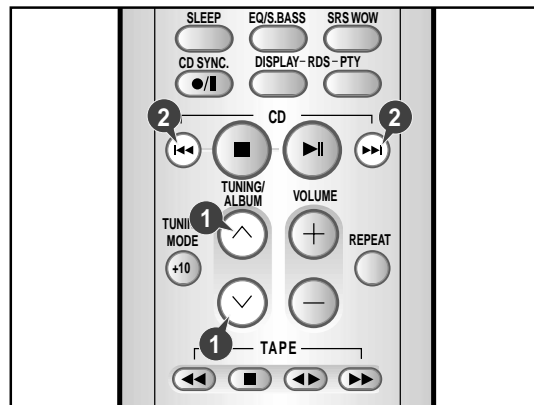

GB



### What is MP3?

MP3 means MPEG1 Layer 3, the global standard for audio signal compression technology. It uses digital compression technology to compress original sound data by up to 12 times without sound quality degradation.

### File Compatibility

- ◆ The unit will playback files created in MP3 format (Mpeg1.Layer3) with \*.mp3 as their extension.
- ◆ Files created in MP2 format (Mpeg1.Layer2) with \*.mp2 as their extension can also be played back.

### How many MP3 files can a CD-R or CD-RW disc record?

The maximum capacity of one CD-R or CD-RW disc is 740MB.  
Normally, one MP3 file has a capacity of 4MB, therefore approximately 180 files can be recorded on a single disc.

### Regarding the playback of CD-R/RW

- ◆ In the case of an original CD-R(Recordable) recorded in audio CD format, CD-RW(Rewritable) and editing by the user, playback is processed on the respective completed status. (The player may not be played back according to the characteristics of the CD or recorded status.)
- ◆ The CD-RW is comparably less reflexive than CD which causes more time delay to read.

## Searching for a Specific Music Passage on a CD

When listening to a compact disc, you can quickly search for a specific music passage on a track.

To search through the tracks...	Press and hold down...
Forwards .....	⏪ for at least one second
Backwards .....	⏩ for at least one second

➤ It is recommended that you turn the volume down before using this function.

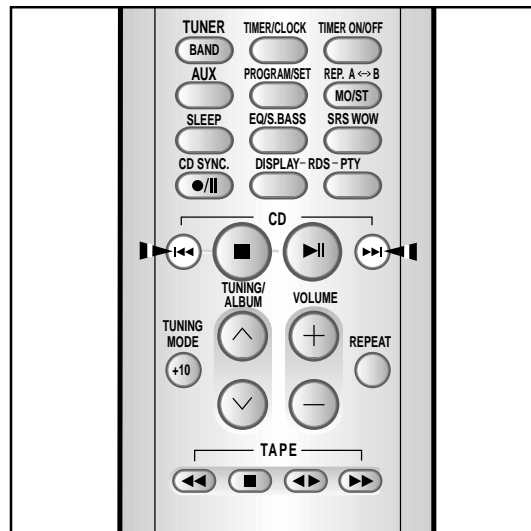

### Playback sequence of albums and tracks

- ◆ In case of Window Explorer display.
- ◆ The arrows indicates playback sequence of albums and tracks.
- ◆ Tracks with jpg, wav or doc only are not audio files and therefore will be skipped.

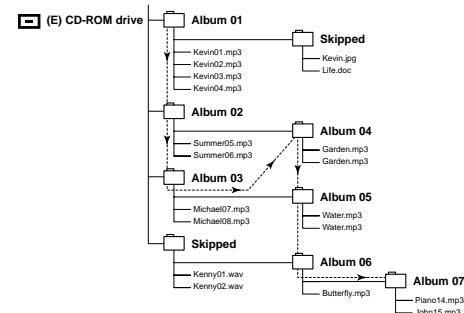

## Function to skip through 10 tracks at a time

Press the +10 button briefly while playing back a CD. The track 10 tracks after the current one will then be played back.

**Example:** If you want to select track 43 during playback of track 15, press the +10 button three times, and then press the ►► button three times.

15 → 20 → 30 → 40 → 41 → 42 → 43



## Repeating One or All Tracks on the Compact Discs

You can repeat indefinitely:

- ◆ A specific track on a compact disc.
- ◆ All tracks on the compact disc selected.

- To repeat...** Press Repeat on the Front Panel one or more times until...

The current track indefinitely ..... **REPEAT 1** is displayed  
All tracks ..... **REPEAT ALL** is displayed

- To cancel this function, press **REPEAT** again.

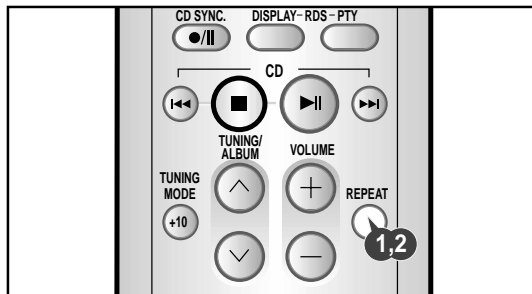

## REPEAT A↔B Function

(This function is not available during playback of an MP3-CD.)

When you select CD(TAPE) Repeat (A↔B) playback, the music passages to which you were listening is repeated 3 times.

- Press **CD(►||)** / **TAPE(◄◄)** button.  
**Result:** The CD(TAPE) player starts playing.
- Press **REP. A↔B** button.  
**Result:** The indications appear: **START**  
◆ A Time is memorized.
- Press **REP. A↔B** button.  
**Result:** The indications appear: **END**  
◆ B Time is memorized.  
◆ Your selected passages are repeated 3 times.
- When you have finished the Repeat playback, press **REP. A↔B**.

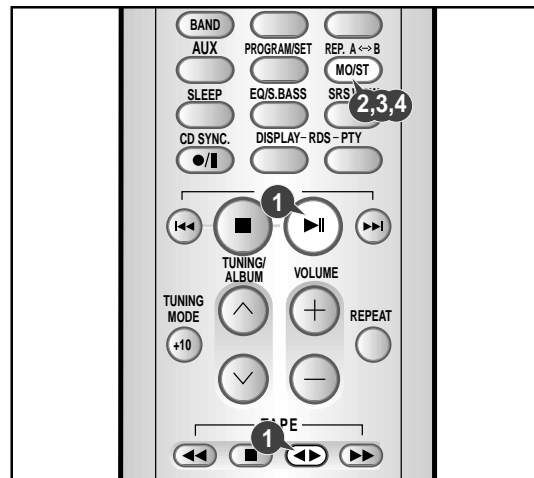

## Resume Function

(This function is only available during playback of an MP3-CD.)

When CD playback is selected again after your CD player has been stopped or turned off, this function allows playback from the start of the track that you last listened to.

- ◆ Press the **PROGRAM/SET** button while your MP3-CD is being played back.
- The **RESUME ON** and **RESUME OFF** may be repeatedly selected.

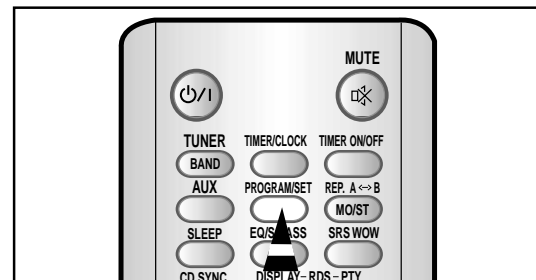

GB

©

## Programming the Order of Playback

(This function is not available during playback of an MP3-CD.)

GB

Ⓢ

You can decide:

- ◆ The order of the track desired to listen
- ◆ The track not desired to listen
  - ◆ A maximum of up to 24 order of tracks desired to listen may be programmed.
  - ◆ Before selecting the track, the CD player should be stopped.
  - ◆ This function may be used simultaneously with the CD Repeat function.
  - ◆ In the case of the MP3-CD, the PROGRAM/SET button may be used as the RESUME ON, OFF function.

- 1 If the CD function is selected, stop the player by pressing ■ button.
- 2 Load the selected CD.
- 3 Press PROGRAM/SET.
 

Result: The following indications are displayed:

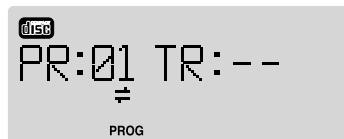

(01 = Program no., -- = Track no. on the disc)

- 4 Select the required track by pressing:
  - ◆ ◀◀ to move back through the tracks
  - ◆ ▶▶ to move forward through the tracks
- 5 Press PROGRAM/SET to confirm your selection.
 

Result: The selection is stored and PR:01 TR:-- is displayed.
- 6 To select other tracks, repeat Steps 4 to 5.
- 7 Press CD (▶||) to listen to the track selection in the order programmed.
- 8 

To...	Press...
Listen to the current track again .....	■ once
Listen to the previous track .....	◀◀ twice
Listen to the next track .....	▶▶ once
Skip forwards or backwards .....	◀◀ or ▶▶ the appropriate number of times
- 9 To cancel the selection, press ■ button.
  - ◆ Once if the compact disc player is stopped

Result: PROG is no longer displayed.

➤ ◆ If you open the compartment, the selection is cancelled.

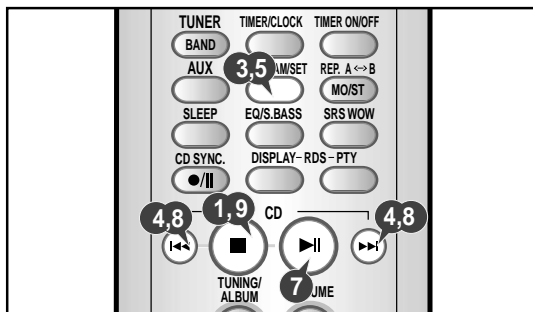

## Checking or Changing Programmed Tracks

You can check or change your selection of tracks at any time.

- 1 Press ■ once if you have started listening to the selection.
- 2 Press PROGRAM/SET button twice.
 

Result: The following indications are displayed:

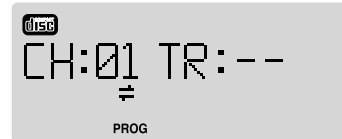

(01 = Program no., -- = Track no. on the disc)

➤ If you have already programmed 24 tracks, Check is displayed instead of CH when you press PROGRAM/SET.

- 3 Press PROGRAM/SET one or more times until the track to be changed is displayed.
- 4 Press ◀◀ or ▶▶ to select a different track.
- 5 Press PROGRAM/SET to confirm your change.
- 6 Press CD (▶||) to start listening to the selection.
 

Result: The first track selected is played.

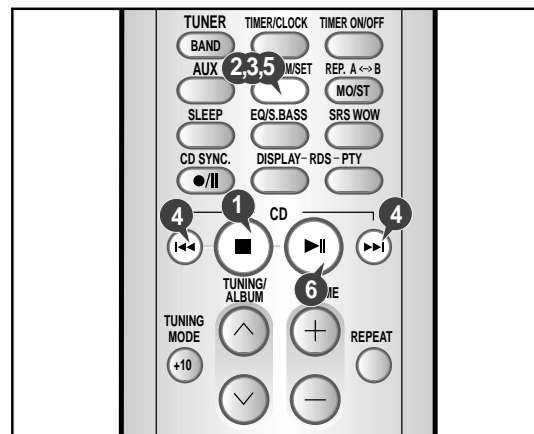

## Searching for and Storing the Radio Stations

You can store up to:

- ◆ 15 FM stations
- ◆ 8 MW stations
- ◆ 7 LW stations

- 1 Switch the system on by pressing (⏻/I).
  - 2 Select the required frequency band by pressing **TUNER/BAND** again on the front panel or **BAND** on the remote control.  
Result: The appropriate indication is displayed:
 

◆ FM	Frequency Modulation
◆ AM(MW)	Medium Wave
◆ LW	Long Wave
  - 3 To search for a station... Press TUNING MODE
 

Manually .....	One or more times until <b>MANUAL</b> is displayed.
Automatically .....	One or more times until <b>AUTO</b> is displayed.

➤ PRESET function is explained in detail in the section "Selecting a Stored Station" on.
  - 4 Select the station to be stored by:
    - ◆ Pressing ◀◀ or ▶▶ buttons on the front panel or ^ or v buttons on the remote control to increase or decrease the frequency respectively.
    - ◆ To scroll through the frequencies faster when searching manually, hold down the ◀◀ or ▶▶ buttons.
    - ◆ The automatic search procedure may stop on a frequency that does not correspond to a radio station. If this happens, use the manual search mode.
  - 5 If you do not want to store the radio station found, revert to Step 4 and search for another station.  
Otherwise:
    - a Press **PROGRAM/SET**.  
Result: The **PROG** is displayed for a few seconds.
    - b Pressing ◀◀ or ▶▶ buttons on the front panel or ^ or v buttons on the remote control to assign a program number between 1 and 15.
    - c Press **PROGRAM/SET** to store the radio station.  
Result: **PROG** is no longer displayed and the station is stored.
  - 6 To store any other radio frequencies required, repeat Steps 3 to 5.
- ◆ The PROGRAM function can be used to assign a new station to an existing program number.

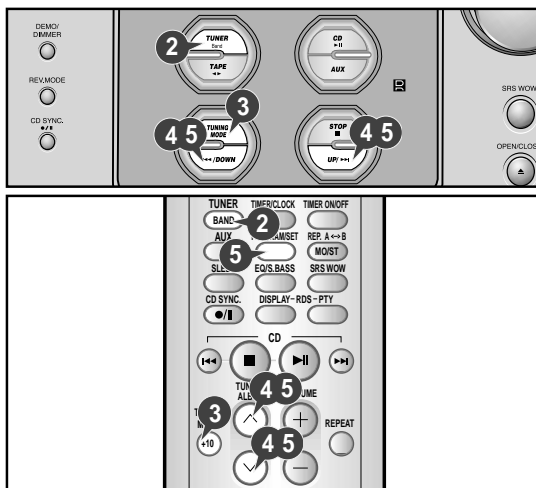

## Selecting a Stored Station

You can listen to a stored radio station as follows:

- 1 Switch the system on by pressing (⏻/I).
- 2 Select the required frequency band by pressing **TUNER/BAND** on the front panel.
- 3 Select the radio station as follows.

To listen to ...	Press ...
Stored station .....	1. the <b>TUNING MODE</b> button until " <b>PRESET</b> " is displayed.
	2. ◀◀ or ▶▶ button to select the required program.

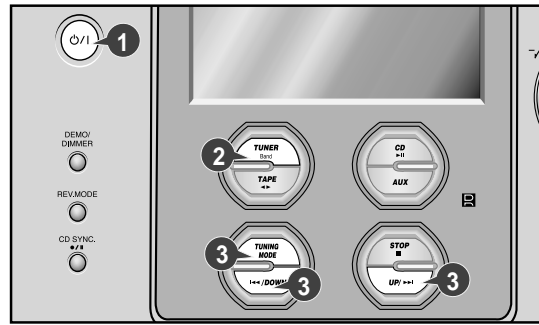

## Improving Radio Reception

You can improve the quality of radio reception by:

- ◆ Rotating the FM or AM(MW) aerial
- If reception from a specific FM radio station is poor, press **MO/ST** to switch from stereo mode to mono. The quality of the sound will be improved.

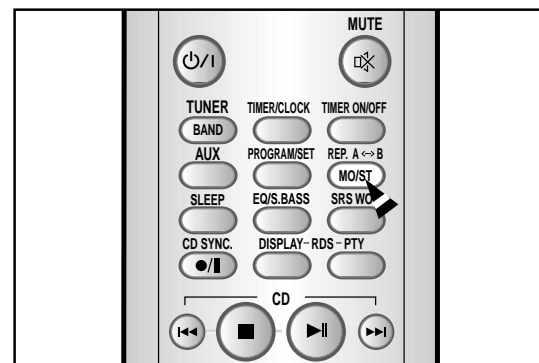

## About RDS broadcasting



This unit has the RDS (Radio Data System) function, which enables for the various information such as broadcasting station, radio text, time and 30 types of programs (News, Rock, Classic, etc.) to be received from the FM RDS station together with normal radio signal.

- 1 Press the (⏻/ I) button.
- 2 Receive the FM radio.
  - ◆ See the radio receiving method on the **page 15**.
  - ◆ FM and frequency are shown on the display
  - ◆ If the received station transfers the RDS information, 'RDS' appears automatically on the display.
- 3 Press the **RDS Display** button to select the desired RDS mode.
  - ◆ Whenever the button is pressed, RDS mode changes as follows.

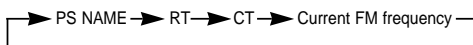

- ◆ The RDS function is available only in **FM** broadcasting.

### Description on RDS function

1. **PTY**(Program Type) : Displays the type of programme currently being broadcast
2. **PS NAME**(Program Service Name) : Indicates the name of broadcasting station and is composed of 8 characters.
3. **RT**(Radio Text) : Decodes the text broadcast by a station (if any) and is composed of maximum 64 characters.
4. **CT**(Clock Time) : Decodes the real time clock from the FM frequency.
  - Some stations may not transmit PTY, RT or CT information therefore this may not be displayed in all cases.
5. **TA**(Traffic Announcement) : When this symbol flashes it shows that the traffic announcement is in progress.



## About RDS DISPLAY function

### About "PS NAME" MODE

- Displays the name of broadcasting station.

Press the **RDS DISPLAY** button to select the PS NAME.

- ◆ **"PS NAME"** appears on the display.
- ◆ If the PS information is being received, the PS name (BBC, AFO, NDR, etc.) is shown on the display.
- ◆ If the PS information isn't received, the original FM frequency is shown.

- ◆ Even though no **RDS DISPLAY** button is pressed, the reception of PS information ensures the PS name is displayed.

### About 'RT' MODE

- Displays the character transmitted from the broadcasting station.

Press the **RDS DISPLAY** button to select the RT MODE.

- ◆ **"RT"** appears on the display.
- ◆ If the RT information is being received, the received information is shown on the display.
- ◆ If the RT information isn't received, the **"NO RT"** is shown. On the display.

### About CT(Clock Time)

- Sets the time of RDS clock.

To select the CT time, set the **RDS DISPLAY** button to CT MODE.

- ◆ The CT information will take up to 2 minutes to be decoded therefore the clock isn't displayed immediately.
- ◆ If there is no received CT information, **"NO CT"** is displayed.



## PTY(Program Type) indication and PTY-SEARCH function

- ◆ The PTY information is composed of an identification symbol, which helps the FM radio to recognize the program type of each FM station.
- ◆ The below 30 PTY information is shown on the display by pressing the Pty button.

Display	Program Type
NEWS	• News including an announced opinion and report
AFFAIRS	• Several matters including a current incident, documentary, discussion and analysis.
INFO	• Information including weights and measures, returns and forecast, matters interesting the customer, medical information, etc.
SPORT	• Sports
EDUCATE	• Education
DRAMA	• Drama-Radio serial, etc.
CULTURE	• Culture-National or local culture including the religious problem, social science, language, theater, etc.
SCIENCE	• Natural science and technology
VARIED	• Others-Speech, amusing program (quiz, game), interview, comedy and satirical play, etc.
POP M	• Pop music
ROCK M	• Rock music
M.O.R.M	• M.O.R- Comfortable music, occasionally vocal or piece
LIGHT M	• Light classical music- Classical music and instrumental and chorus music
CLASSICS	• Heavy classical music-Orchestra music, symphony, chamber music and opera
OTHER M	• Other music - Jazz, R&B country music
WEATHER	• Weather
FINANCE	• Finance
CHILDREN	• Children's programmes
SOCIAL	• Social affairs
RELIGION	• Religion
PHONE IN	• Phone in
TRAVEL	• Travel
LEISURE	• Leisure
JAZZ	• Jazz Music
COUNTRY	• Country Music
NATION M	• National Music
OLDIES	• Oldies Music
FOLK M	• Folk Music
DOCUMENT	• Documentary
TEST	• Alarm Test

### About PTY-SEARCH

- 1 Receive the FM radio.
    - ◆ See the radio receiving method on the **page 15**.
    - ◆ The FM and frequency appear on the display.
      - ◆ If the received station is transmitting the RDS information, "RDS" lights up.
  - 2 Press the **PTY** button.
    - ◆ The PTY MODE(NEWS, AFFAIRS, etc.) appears on the display.
    - ◆ Press the TUNING **◀◀** or **▶▶** button to select the desired PTY MODE.
- ◆ If the station is transmitting no PTY information, 'NO PTY' lights on the display.
- ◆ When the PTY MODE is selected(The PTY MODE is shown on the display), press the PTY KEY once again to convert into PTY-SEARCH MODE and auto-search the station sequentially.
- ◆ If the PTY MODE received in the course of auto-search agrees with the selected PTY MODE, the auto-search stops and the PTY-SEARCH is finished.
- If the PTY MODE which agrees with the PTY MODE selected in the course of auto-search, isn't received, it is returned to the first frequency at beginning the PTY SEARCH and the auto-search and PTY SEARCH are suspended.

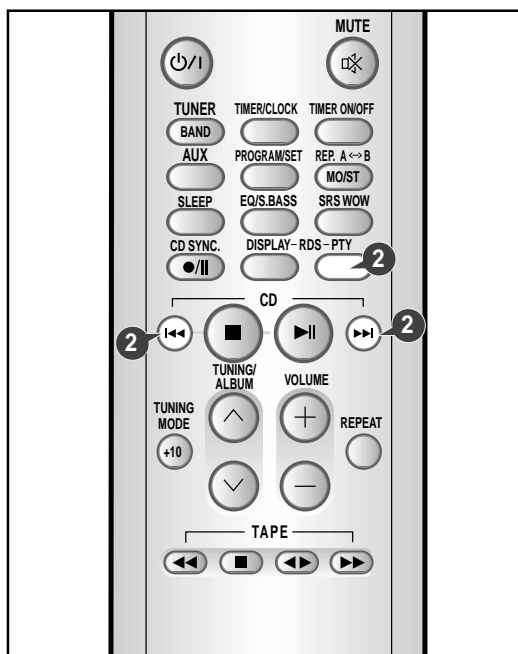

## Listening to a Cassette



- Always treat your cassettes with care; refer, if necessary, to the section entitled "Precautions When Using Audio Cassettes" on page 24.

- 1 Switch the system on by pressing (⏻ / I).
- 2 Open the cassette deck by pushing on the corner of the cover marked **PUSH EJECT** (▲) until you hear a click and then releasing it.
  - ◆ Insert the pre-recorded cassette with the open edge of the tape facing downwards.
- 3 Close the deck by pushing on it until it clicks into place.
- 4 

To listen to...	Press ...
Side A	Tape (◀▶) button once.
Side B	Tape (◀▶) button twice.

**Result:** The cassette starts playing.
- 5 Press the ◀▶, ▶▶ or ◀◀, ▶▶ button if necessary.
 

To...	Press ...
Rewind the cassette	◀◀ / DOWN button.
Fast-forward the cassette	▶▶ / UP button.
- 6 When you have finished playback, press ■ button.

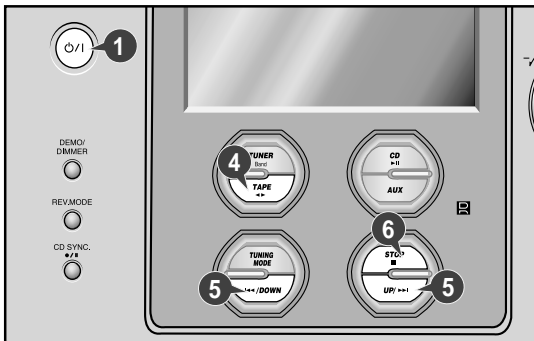

## Selecting the Cassette Playback Mode

Your micro component system has three cassette playback modes which enable you to listen to both sides of a cassette automatically. Press REV.MODE until the appropriate symbol is displayed.

**When the display indicates... The micro component system plays back...**

- One side of the selected cassette and then stops.
- One side of the cassette. The other side of the cassette and then stops.
- Both sides of the cassette indefinitely until you press stop.

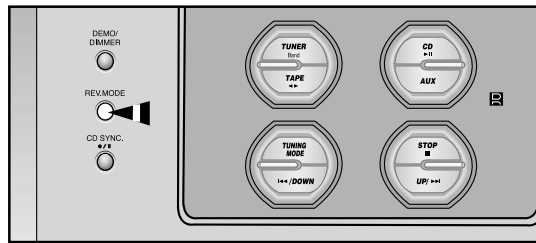

## Recording a Compact Disc

You can record a compact disc on a cassette in two different ways:

- ◆ Synchronised recording
- ◆ Direct recording

### Synchronised recording

This feature enables you to synchronize the start of the recording with the start of the disc or track of your choice.

- 1 Switch the system on by pressing (⏻/|).
- 2 Insert a blank cassette in Deck.
  - ◆ Press the **PUSH/EJECT** button (⏻) to open the cassette door, insert a cassette, and then close the cassette door.
  - ◆ Insert the cassette with the safety tabs.
- 3 Load a compact disc.
  - ◆ Press the **OPEN/CLOSE** button (⏻) to open the CD door.
  - ◆ Insert a CD and press the **OPEN/CLOSE** button (⏻) to close the CD door.
- 4 Press the **CD** (▶||) button.
  - ◆ Use the CD selection (◀◀, ▶▶) buttons to select the desired song.
- 5 Press and hold **CD SYNC.** button.
  - ◆ When stopped, press the button to start the recording from the first piece of music.
  - ◆ Press and hold **CD SYNC.** button during the playback of CD to start the recording from the first part of the music being played.
- 6 To stop recording, press ■ button.

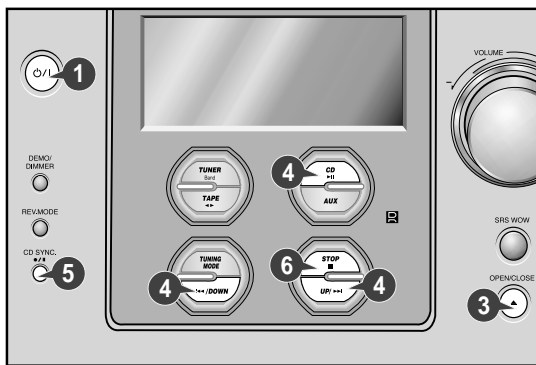

### Direct recording

The direct recording mode enables you to start recording with any track on the compact disc.

- ◆ You do not need to adjust the volume, as it has no effect on the recording.

- 1 Switch the system on by pressing (⏻/|).
- 2 Insert a blank cassette in Deck.
  - ◆ Press the **PUSH/EJECT** button (⏻) to open the cassette door, insert a cassette, and then close the cassette door.
  - ◆ Insert the cassette with the safety tabs.

- 3 Load a compact disc.
  - ◆ Press the **OPEN/CLOSE** button (⏻) to open the CD door.
  - ◆ Insert a CD and press the **OPEN/CLOSE** button (⏻) to close the CD door.
- 4 Press the **CD** (▶||) button.
  - ◆ Use the CD selection (◀◀, ▶▶) buttons to select the desired song.
- 5 Press the ●/|| (**REC/PAUSE**) button.
 

**Result:** ◆ Recording will begin.

  - ◆ To stop recording, press ■ button.

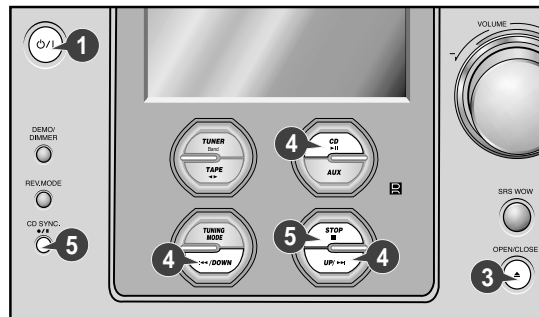

## Recording a Radio Program

You can record a radio program of your choice.

- ◆ You do not need to adjust the volume, as it has no effect on the recording.

- 1 Switch the system on by pressing (⏻/|).
- 2 Insert a blank cassette in Deck.
- 3 Select the **TUNER** function by pressing **TUNER/BAND**.
- 4 Select the radio station that you wish to record by pressing ◀◀ or ▶▶ button.
- 5 Press ●/|| (**REC/PAUSE**).
 

**Result:** **REC** is displayed in red and recording starts.
- 6 To stop recording, press ■ button.

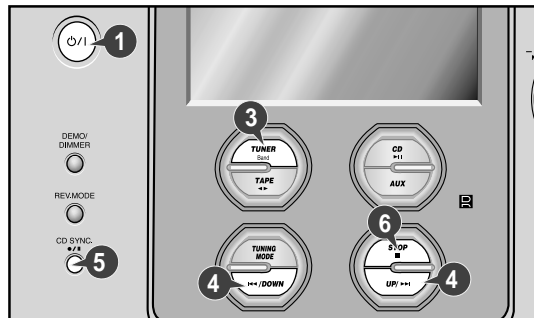

GB

RECALL

## Timer Function

GB

The timer enables you to switch the system on or off at specific times.

**Example:** You wish to wake up to music every morning.

- If you no longer want the system to be switched on or off automatically, you must cancel the timer.
- ◆ Before setting the timer, check that the current time is correct.
- ◆ For each step, you have a few seconds to set the required options. If you exceed this time, you must start again.

- 1 Switch the system on by pressing (⏻/I).
- 2 Press **TIMER/CLOCK** until **TIMER** is displayed.
- 3 Press **Program/Set**.  
**Result:** **ON TIME** is displayed (instead of the equalizer symbols) for a few seconds, followed by any switch-on time already set; you can set the timer switch-on time.
- 4 Set the timer switch-on time.
  - a Set the hour by pressing ◀◀ or ▶▶ button.
  - b Press **PROGRAM/SET**.  
**Result:** The minutes flash.
  - c Set the minutes by pressing ◀◀ or ▶▶ button.
  - d Press **PROGRAM/SET**.  
**Result:** **OFF TIME** is displayed (instead of the equalizer symbols) for a few seconds, followed by any switch-off time already set; you can now set the timer switch-off time.
- 5 Set the timer switch-off time.
  - a Set the hour by pressing ◀◀ or ▶▶ button.
  - b Press **PROGRAM/SET**.  
**Result:** The minutes flash.
  - c Set the minutes by pressing ◀◀ or ▶▶ button.
  - d Press **PROGRAM/SET**.  
**Result:** **VOL 10** is displayed, where **10** corresponds to the volume already set.
- 6 Press ◀◀ or ▶▶ button to adjust the volume level and press **PROGRAM/SET**.  
**Result:** The source to be selected is displayed.
- 7 Press ◀◀ or ▶▶ button to select the source to be played when the system switches on.
 

If you select...	You must also...
TAPE (cassette) .....	Insert a cassette tape.
TUNER (radio) .....	a Press <b>PROGRAM/SET</b> . b Select a preset station by pressing Tuning ◀◀ or ▶▶.
CD (compact disc) .....	Load a compact disc.
- 8 Press **PROGRAM/SET** to confirm the timer.
- 9 Press (⏻/I) to set the system to standby mode.  
**Result:** ⏻ is displayed to the bottom left of the time, indicating that the timer has been set. The system will switch on and off automatically at the required times.

- ◆ If the timer switch on and off times are identical, the word **ERROR** is displayed.

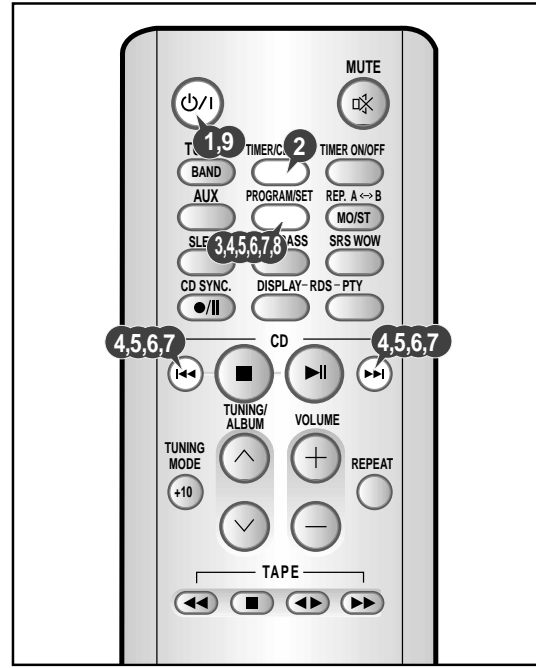

## Canceling the Timer

After having set the timer, it will start automatically as shown by the **TIMER** indication on the display. If you no longer wish to use the timer, you must cancel it.

- You can stop the timer at any time (system on or in standby mode).

To...	Press <b>TIMER ON/OFF</b> ...
Cancel the timer .....	Once. <b>Result:</b> ⏻ is no longer displayed.
Restart the timer .....	Twice. <b>Result:</b> ⏻ is displayed again.

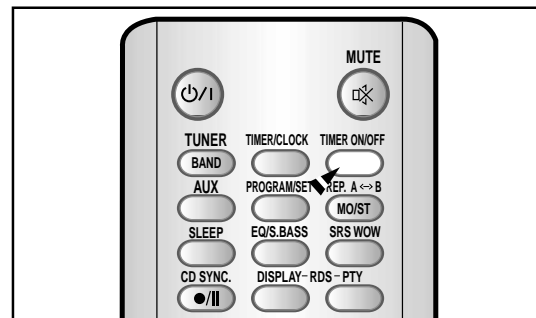

## EQ/S.BASS Function

Your micro component system is equipped with a preset equalizer that allows you to choose the most appropriate balance between treble and bass frequencies, according to the type of music you are listening to. The function of Power Sound amplifies bass and improves high key or bass twice as much for you to appreciate powerful real sound.

Press **EQ/S.BASS** on the front panel until the required option is selected.

**Result:** Press the button repeatedly to select "**CLASSISC → ROCK → POP → S.BASS → P.SOUND**".

- ◆ **S.BASS Function** : S.Bass function emphasizes the bass sound to produce the effect of explosion or booms.
- ◆ **P.SOUND Function** : You can experience the powerful and realistic sound by amplifying bass and improving the sound quality of high- and low-pitched sounds by two-fold.

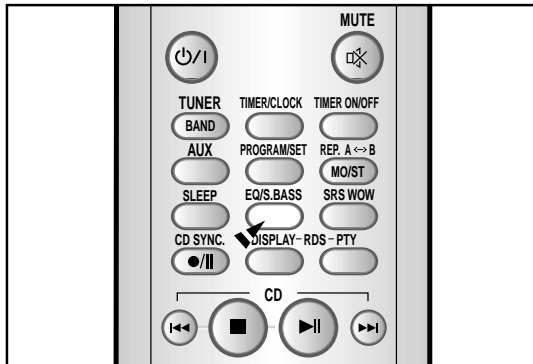

## SRS WOW Function



You can enjoy realistic surround sound by using the SRS and TruBass sound field functions and the SRS WOW function that enhances sound clarity.

**Press the SRS WOW button.**

**Result:** Each time the button is pressed, the selection changes as follows: **TRU BASS → SRS → SRS WOW**.

- ◆ **TruBASS Function**: Enhances the bass and low frequencies to produce deep and rich bass sounds.
- ◆ **SRS Function**: Provides the surround sound that fills the room.
- ◆ **SRS WOW Function**: Provides the surround sound effects with enhanced sound field depth and bass, through speakers and headphones.

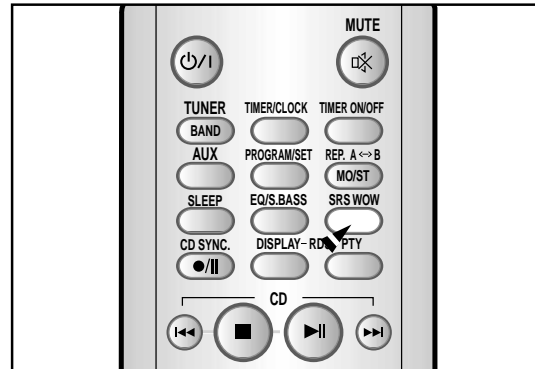

◆ **SRS** is a trademark of SRS Labs, Inc.

◆ **WOW** technology is incorporated under license from SRS Labs, Inc.

## MUTE Function

GB

You can turn the sound off temporarily on your system.  
Example: You wish to answer a telephone call.

- 1 Press **MUTE** (🔇).
- 2 To switch the sound back on (at the same volume as before), press **MUTE** again or the **VOLUME** buttons.



## Setting the System to Switch off Automatically

While listening to a compact disc or a cassette, you can set the system to switch off automatically.

Example: You wish to go to sleep to music.

- 1 Press **SLEEP**.  
Result: The following indications are displayed:  
**90 MIN**
- 2 Press **SLEEP** one or more times to indicate how long the system should continue playing before it switches off:  
**90 MIN → 60 MIN → 45 MIN**  
**OFF ← 15 MIN ← 30 MIN**  
➤ At any time, you can:
  - ◆ Check the remaining time by pressing **SLEEP**
  - ◆ Change the remaining time by repeating Steps 1 and 2
- 3 To cancel SLEEP function, press **SLEEP** one or more times until **OFF** is display.

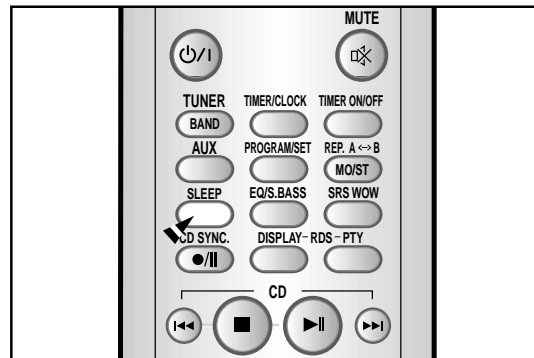

## Connecting Headphones

You can connect a set of headphones to your micro component system so that you can listen to music or radio programmers without disturbing other people in the room. The earphones must have a 3.5Ø jack or an appropriate adapter.

Connect the headphones to the **PHONES** jack on the front panel.  
Result: The loudspeakers are no longer used to output the sound.

- ⚠ Prolonged use of headphones at a high volume may damage your hearing.

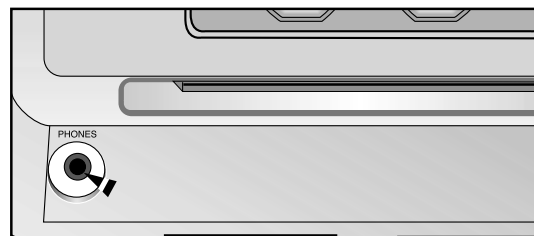

## Safety Precautions

The following diagrams illustrate the precautions to be taken when using or moving your micro component system.

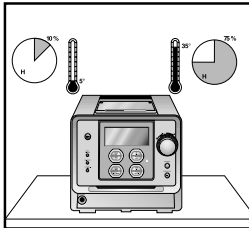

Ambient operating conditions:  
Ambient temperature 5°C-35°C  
Humidity 10-75%

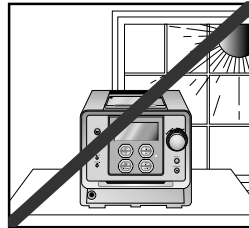

Do not expose the unit to direct sun radiation or other heat sources. This could lead to overheating and malfunction of the unit.

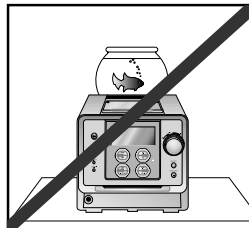

Do not place potted plants or vases on top of the unit. Moisture entering the unit could lead to dangerous electric shock and can cause equipment damage. In such events immediately disconnect the main plug from the socket.

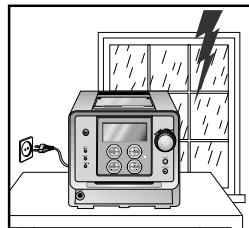

During thunderstorms, disconnect the main plug from the socket. Main voltage peaks due to lightning could damage the unit.

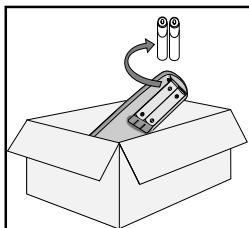

Remove the batteries from the remote control, if not used for any extended period. Leaking batteries can cause serious damage to the remote control.

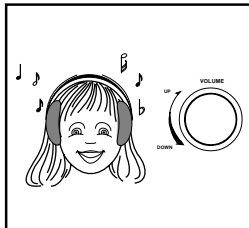

When using headphones, take care not to listen at excessive volumes. Extended use of headphones at high volumes will lead to hearing damage.

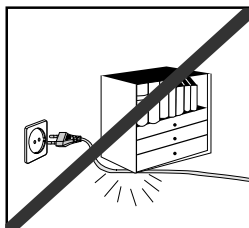

Do not place heavy items on the main lead. Main cable damage can lead to damage of the equipment (fire hazard) and can cause electric shock.

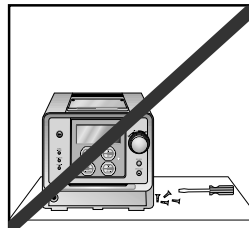

Do not remove any equipment panels. The inside of the unit contains live components, which cause electric shock.

## Cleaning Your Micro Component System

GB

To obtain the best possible results from your micro component system, you must clean the following elements regularly:

- ◆ The outer casing
- ◆ The compact disc player
- ◆ The cassette players (heads, rollers and drive capstans)
- ◆ Always unplug the system from the wall outlet:
  - ◆ Before cleaning it
  - ◆ If you are not going to be using it for a long time

### Outer Casing

Clean the outer casing regularly using a soft cloth and a light detergent. Do not use abrasive powders, liquids or aerosol cleaners. Never let any liquids get into the system.

### Compact Disc Player

- 1 Before playing a compact disc, clean it with a special CD cleaning agent. Do not use the same cleaning agents as for vinyl LP records. Carefully wipe the disc from the centre outward.
- 2 Regularly clean the player with a special cleaning disc (available from your local dealer).

### Tape Decks

- 1 Press **PUSH EJECT** (▲) to open the cassette deck.
- 2 Use a cotton bud and a special cassette cleaning agent to clean the:
  - ◆ Head (1)
  - ◆ Rollers (2)
  - ◆ Drive capstans (3)

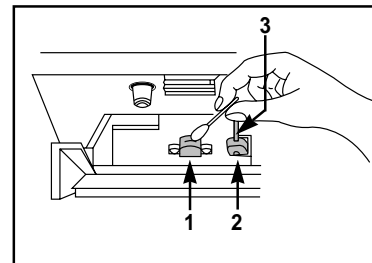

- ◆ If you will not be using the remote control for a long time, remove the batteries to prevent corrosion.
- ◆ Although your system is very hard-wearing, it should not be used in an excessively dusty environment or subjected to shocks or extreme heat (close to heating appliances or in direct sunlight, etc.).
- ◆ If the unit emits an unpleasant odor when in use, unplug it from the main supply and contact the after-sales service.

## Precautions When Using Compact Discs

GB

- ◆ Handle your compact discs with care. Always hold them by the edges to avoid leaving fingerprints on the shiny surface.
- ◆ When you have finished playing a compact disc, always put it back in its case.
- ◆ Do not fix paper or adhesive tape to the discs and do not write on the label.
- ◆ Clean them with a special-purpose cloth.
- ◆ Store your compact discs in a clean place, out of direct sunlight, where they will not be exposed to high temperatures.
- ◆ Always use compact discs marked .



## Precautions When Using Audio Cassettes

- ◆ Check that the tape in the cassette is sufficiently taut.
- ◆ To prevent erasing a cassette that you wish to keep, remove the safety tab on the upper edge of the cassette. To record a cassette, where the tab has been broken, simply cover the opening with adhesive tape.
- ◆ When you have finished playing a cassette, always put it back in its case.
- ◆ Store your cassettes in a clean place, out of direct sunlight, where they will not be exposed to high temperatures.
- ◆ Avoid using 120-minute cassettes as they place unnecessary strain on the tape mechanism.

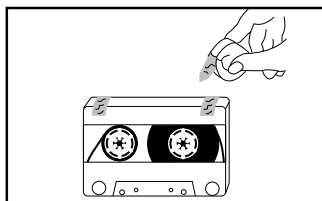
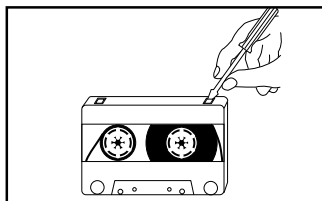
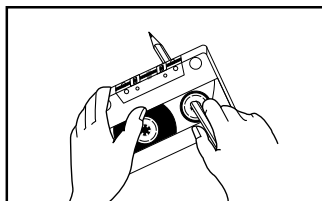

## Before Contacting the After-Sales Service

It always takes a little time to become familiar with a new appliance. If you have any of the problems listed below, try the solutions given. They may save you the time and inconvenience of an unnecessary service call.

	Problem	Checks/Explanation
G E N E R A L	The system does not work	<ul style="list-style-type: none"> <li>• The main lead is not correctly plugged into a wall socket or the wall socket is not switched on.</li> <li>• The remote control batteries need replacing or the polarity has not been respected.</li> <li>• The <math>\odot / 1</math> button has not been pressed.</li> </ul>
	There is no sound	<ul style="list-style-type: none"> <li>• The volume has been completely turned down.</li> <li>• The correct function (TUNER, CD, TAPE, AUX) has not been selected.</li> <li>• You have connected a set of earphones.</li> <li>• The loudspeaker wires have been disconnected.</li> <li>• The MUTE button has been pressed.</li> </ul>
	The Timer does not work	<ul style="list-style-type: none"> <li>• The timer has been stopped by pressing <b>TIMER ON/OFF</b>.</li> </ul>
C D	In case it does not work, even the action is taken as above.	<ul style="list-style-type: none"> <li>• Press the <b>SRS WOW</b> button for 5 seconds in power 'OFF'(standby), then it is returned the original position (RESET)</li> </ul>
	The compact disc player does not start playing	<ul style="list-style-type: none"> <li>• The CD function has not been selected.</li> <li>• The disc has been inserted face down or is either dirty or scratched.</li> <li>• The laser sensor is dirty or dusty.</li> <li>• The system has not been installed on a flat, horizontal surface.</li> <li>• Condensation has formed in the player; leave the system in a warm, airy room for at least one hour.</li> </ul>
C A S S E T T E S	The tape does not start playing	<ul style="list-style-type: none"> <li>• The TAPE function has not been selected.</li> <li>• The cassette has not been inserted correctly.</li> <li>• The cassette player has not been closed.</li> <li>• The tape is either slack or broken.</li> </ul>
	The volume falls off The cassette is not erased correctly There is excessive wow and flutter	<ul style="list-style-type: none"> <li>• The audio heads are dirty.</li> <li>• The rollers or drive capstans are dirty.</li> <li>• The tape is worn.</li> </ul>
R A D I O	Reception is poor or no radio stations are received at all	<ul style="list-style-type: none"> <li>• The TUNER function has not been selected.</li> <li>• The radio frequency has not been correctly selected.</li> <li>• The aerial has been disconnected or is not facing the right way. Turn it until you find the best orientation.</li> <li>• You are in a building that blocks radio waves; you must use an outside aerial.</li> </ul>

If the above guidelines do not allow you to solve the problem, take a note of:

- ◆ The model and serial numbers, normally printed on the rear of the system
- ◆ Your warranty details
- ◆ A clear description of the problem

Then contact your local dealer or SAMSUNG after-sales service.



## Technical Specifications



SAMSUNG strives to improve its products at all times. Both the design specifications and these user instructions are thus subject to change without notice.

---

<b>RADIO</b>	
<b>LW</b>	
Usable sensitivity	60 dB
<b>AM (MW)</b>	
Signal/noise ratio	40 dB
Usable sensitivity	56 dB
Total harmonic distortion	2 %
<b>FM</b>	
Signal/noise ratio	60 dB
Usable sensitivity	3 dB
Total harmonic distortion	1.0 %
.....	
<b>COMPACT DISC PLAYER</b>	
Frequency range	20 Hz - 20 KHz ( $\pm$ 1 dB)
Signal/noise ratio	90 dB (at 1 KHz) with filter
Distortion	0.05 % (at 1 KHz)
Channel separation	80 dB
Disc sizes	Diameter: 120 or 80 mm. Thickness: 1.2 mm
.....	
<b>TAPE DECK</b>	
Frequency range	125 Hz ~ 10 KHz
Signal/noise ratio	40 dB
Channel separation	35 dB
Erasing effect	60 dB
.....	
<b>AMPLIFIER</b>	
Output power	
♦ Main(6 $\Omega$ ) .....	2 X 25 Watts RMS (total harmonic distortion : 10%)
Channel separation	50 dB
Signal/noise ratio	80 dB
.....	
<b>GENERAL</b>	
Dimensions	194(W) x 172 (H) x 310(D) mm

---

**THIS APPLIANCE IS MANUFACTURED BY:**

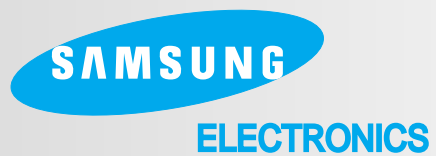

**AH68-01331B**