

PCL-818 Series

12-bit ISA Multifunction Card

User Manual

Copyright

The documentation and the software included with this product are copyrighted 2007 by Advantech Co., Ltd. All rights are reserved. Advantech Co., Ltd. reserves the right to make improvements in the products described in this manual at any time without notice. No part of this manual may be reproduced, copied, translated or transmitted in any form or by any means without the prior written permission of Advantech Co., Ltd. Information provided in this manual is intended to be accurate and reliable. However, Advantech Co., Ltd. assumes no responsibility for its use, nor for any infringements of the rights of third parties, which may result from its use.

Acknowledgements

Intel and Pentium are trademarks of Intel Corporation.

Microsoft Windows and MS-DOS are registered trademarks of Microsoft Corp.

All other product names or trademarks are properties of their respective owners.

Part No. 20038180A0

2nd Edition

Printed in Taiwan

January 2007

Product Warranty (2 years)

Advantech warrants to you, the original purchaser, that each of its products will be free from defects in materials and workmanship for two years from the date of purchase.

This warranty does not apply to any products which have been repaired or altered by persons other than repair personnel authorized by Advantech, or which have been subject to misuse, abuse, accident or improper installation. Advantech assumes no liability under the terms of this warranty as a consequence of such events.

Because of Advantech's high quality-control standards and rigorous testing, most of our customers never need to use our repair service. If an Advantech product is defective, it will be repaired or replaced at no charge during the warranty period. For out-of-warranty repairs, you will be billed according to the cost of replacement materials, service time and freight. Please consult your dealer for more details.

If you think you have a defective product, follow these steps:

1. Collect all the information about the problem encountered. (For example, CPU speed, Advantech products used, other hardware and software used, etc.) Note anything abnormal and list any onscreen messages you get when the problem occurs.
2. Call your dealer and describe the problem. Please have your manual, product, and any helpful information readily available.
3. If your product is diagnosed as defective, obtain an RMA (return merchandise authorization) number from your dealer. This allows us to process your return more quickly.
4. Carefully pack the defective product, a fully-completed Repair and Replacement Order Card and a photocopy proof of purchase date (such as your sales receipt) in a shippable container. A product returned without proof of the purchase date is not eligible for warranty service.
5. Write the RMA number visibly on the outside of the package and ship it prepaid to your dealer.

Declaration of Conformity

CE

This product has passed the CE test for environmental specifications when shielded cables are used for external wiring. We recommend the use of shielded cables. This kind of cable is available from Advantech. Please contact your local supplier for ordering information.

Technical Support and Assistance

- Step 1. Visit the Advantech web site at **www.advantech.com/support** where you can find the latest information about the product.
- Step 2. Contact your distributor, sales representative, or Advantech's customer service center for technical support if you need additional assistance. Please have the following information ready before you call:
 - Product name and serial number
 - Description of your peripheral attachments
 - Description of your software (operating system, version, application software, etc.)
 - A complete description of the problem
 - The exact wording of any error messages

Safety Instructions

1. Read these safety instructions carefully.
2. Keep this User's Manual for later reference.
3. Disconnect this equipment from any AC outlet before cleaning. Use a damp cloth. Do not use liquid or spray detergents for cleaning.
4. For plug-in equipment, the power outlet socket must be located near the equipment and must be easily accessible.
5. Keep this equipment away from humidity.
6. Put this equipment on a reliable surface during installation. Dropping it or letting it fall may cause damage.
7. The openings on the enclosure are for air convection. Protect the equipment from overheating. **DO NOT COVER THE OPENINGS.**
8. Make sure the voltage of the power source is correct before connecting the equipment to the power outlet.
9. Position the power cord so that people cannot step on it. Do not place anything over the power cord.
10. All cautions and warnings on the equipment should be noted.
11. If the equipment is not used for a long time, disconnect it from the power source to avoid damage by transient overvoltage.
12. Never pour any liquid into an opening. This may cause fire or electrical shock.
13. Never open the equipment. For safety reasons, the equipment should be opened only by qualified service personnel.
14. If one of the following situations arises, get the equipment checked by service personnel:
 - a. The power cord or plug is damaged.
 - b. Liquid has penetrated into the equipment.
 - c. The equipment has been exposed to moisture.
 - d. The equipment does not work well, or you cannot get it to work according to the user's manual.
 - e. The equipment has been dropped and damaged.
 - f. The equipment has obvious signs of breakage.
15. **DO NOT LEAVE THIS EQUIPMENT IN AN ENVIRONMENT WHERE THE STORAGE TEMPERATURE MAY GO BELOW -**

20° C (-4° F) OR ABOVE 60° C (140° F). THIS COULD DAMAGE THE EQUIPMENT. THE EQUIPMENT SHOULD BE IN A CONTROLLED ENVIRONMENT.

16. CAUTION: DANGER OF EXPLOSION IF BATTERY IS INCORRECTLY REPLACED. REPLACE ONLY WITH THE SAME OR EQUIVALENT TYPE RECOMMENDED BY THE MANUFACTURER, DISCARD USED BATTERIES ACCORDING TO THE MANUFACTURER'S INSTRUCTIONS.

The sound pressure level at the operator's position according to IEC 704-1:1982 is no more than 70 dB (A).

DISCLAIMER: This set of instructions is given according to IEC 704-1. Advantech disclaims all responsibility for the accuracy of any statements contained herein.

Contents

Chapter 1	Overview	2
1.1	Introduction	2
1.2	Features	3
1.3	Applications	4
1.4	Installation Guide	5
	Figure 1.1:Installation Flow Chart	6
1.5	Software Overview	7
1.6	Device Driver Roadmap	8
1.7	Accessories	10
Chapter 2	Installation	12
2.1	Unpacking	12
2.2	Driver Installation	13
	Figure 2.1:Advantech Automation Software Setup	13
	Figure 2.2:Options for Driver Setup	14
2.3	Hardware Installation	15
2.4	Device Setup & Configuration	16
	Figure 2.3:Device Manager	16
	Figure 2.4:Device Settings	17
	Figure 2.5:Device Name	18
	Figure 2.6:Test Utility	19
Chapter 3	Signal Connections	22
3.1	Overview	22
3.2	Switch & Jumper Settings	22
	Figure 3.1:Connectors, Jumpers& Switches	22
3.3	Signal Connections	30
3.3.1	Pin Assignments	30
3.3.2	I/O Connector Signal Description	31
	Figure 3.2:Analog Output Connections	34
3.4	Field Wiring Considerations	36
Appendix A	Specifications	38
A.1	Analog Input	38
A.2	Analog Output	39
A.3	Digital Input /Output	39
A.4	Counter/Timer	40
A.5	General	40
Appendix B	Block Diagram	42
B.1	PCL-818HD/HG	42
B.2	PCL-818L	42
Appendix C	Register Structure & Format	44
C.1	Overview	44
C.2	I/O Port Address Map	44
C.3	A/D Data & Channels — BASE+00H~01H	47

C.4	Software A/D Trigger — BASE+00H	48
C.5	A/D RangeControl — BASE+01H	48
C.6	MUX Scan Channel Control — BASE+02H	50
C.7	MUX Scan Channel Status — BASE+02H	52
C.8	Digital I/O Registers - BASE + 03/0BH	52
C.9	D/A Output — BASE+04/05H	53
C.10	FIFO Interrupt Control — BASE+06H	54
C.11	Clear Interrupt Request — BASE+08H	55
C.12	A/D Status — BASE+08H	55
C.13	A/D Control — BASE+09H	57
C.14	Timer/Counter Enable — BASE+0AH	59
C.15	Programmable Timer/Counter — BASE+0C~0FH	59
C.16	Clear FIFO Interrupt Request — BASE+14H	60
C.17	A/D Data and Channel from FIFO - BASE + 17/18H	60
C.18	FIFO Status — BASE+19H	61
C.19	FIFO Clear — BASE+19H	62
Appendix D	Calibration	64
D.1	VR Assignment	65
	Figure D.1:PCL-818HD/HG/L VR Assignment	65
D.2	A/D Calibration	66
D.3	D/A Calibration	66

Overview

Sections include:

- Introduction
- Features
- Applications
- Installation guide
- Software Overview
- Device Driver Roadmap
- Accessories

Chapter 1 Overview

1.1 Introduction

Thank you for buying the Advantech PCL-818HD/HG/L. The PCL-818HD/HG/L is a high-performance multifunction data acquisition card for IBM PC/XT/AT or compatible computers. It offers the five most desired measurement and control functions: 12-bit A/D conversion, D/A conversion, digital input, digital output and timer/counter.

A programmable-gain instrument amplifier (x 0.5, 1, 2, 4 and 8) lets you acquire different input signals without external signal conditioning. An onboard 1 K word FIFO buffer provides high-speed data transfer and predictable performance under Windows.

Automatic channel scanning circuitry and on-board SRAM let you perform multiple-channel A/D conversion with DMA and individual gains for each channel.

The PCL-818HD uses a CPLD chip designed in-house by Advantech engineers. This single chip integrates most of the card's functions, giving you maximum accuracy and reliability, along with minimum cost, size and power consumption.

The PCL-818HD is hardware and software compatible with its popular predecessor, the PCL-818HG. This puts rich software support and a wide variety of external signal conditioning boards at your disposal.

1.2 Features

- 16 single-ended or eight differential analog inputs, switch selectable
- 12-bit A/D, up to 100 KHz sampling rate with DMA transfer and different gain for each channel
- Software-selectable gain: x 0.5, 1, 2, 4 or 8
- Onboard 1 K word FIFO buffer with software selectable interrupt
- Software selectable analog input ranges (VDC):
- Bipolar: +/-0.625, +/-1.25, +/-2.5, +/-5, +/-10
- Unipolar: 0 to 1.25, 0 to 2.5, 0 to 5, 0 to 10
- 16 digital inputs and 16 digital outputs, TTL/DTL compatible
- One 12-bit analog output channel
- Flexible triggering options: software, programmable pacer and external pulse
- Data transfers by program control, interrupt handler routine or DMA

The PCL-818HD/HG/L offers the following main features:

Automatic Channel/Gain Scanning

The PCL-818HD/HG/L features an automatic channel/gain scanning circuit. This circuit, instead of your software, controls multiplexer switching during sampling. On-board SRAM stores different gain values for each channel. This combination lets you perform multi-channel high-speed sampling (up to 100 KHz) with different gains for each channel and DMA data transfer.

Wide Selection with Migration Path

The PCL-818HD/HG/L lets you choose the card that exactly matches your application and price range. The PCL-818HD/HG/L is the perfect choice if you are on a tight budget. It offers the best price/performance in the market. If you need more power, you can easily upgrade to any other card in the series. The PCL-818HD/HG/L is connector compatible. All your programs will work with your new card, protecting your investment.

Keeping Output Values after System Reset

When the system is hot reset (power not shut down), the PCL-818HD/HG/L can either retain the last analog output values, or return to its default configuration, depending on the jumper setting. This practical function eliminates danger caused by improper operation during unexpected system reset.

Board ID

The PCL-818HD/HG/L has a built-in DIP Switch that helps define each card's ID when multiple PCL-818HD/HG/L cards have been installed on the same PC chassis. The board ID setting function is very useful when users build their system with multiple PCL-818HD/HG/L cards. With correct Board ID settings, you can easily identify and access each card during hardware configuration and software programming.

Note: For detailed specifications of the PCL-818HD/HG/L, please refer to Appendix A, Specifications.

1.3 Applications

- Transducer and sensor measurements
- Waveform acquisition and analysis
- Process control and monitoring
- Vibration and transient analysis

1.4 Installation Guide

Before you install your PCL-818HD/HG/L card, please make sure you have the following necessary components:

- **PCL-818HD/HG/L DA&C Card**
- **PCL-818HD/HG/L User's Manual**
- **Driver Software** Advantech DLL drivers (included in the CD-ROM)
- **Wiring Cable** PCL-10120/10137 (option)
- **Wiring Board** ADAM-3920/3937, PCLD-7216/780/782/782B/785/785B/786/788/789D/880/885/8115 (optional)
- PC or workstation with a PCI-bus slot (Win 95/98/NT/2000/ME/XP)

Some other optional components are available for enhanced operation:

- Application software ActiveDAQ, GeniDAQ or 3rd party software

After you get the necessary components and maybe some of the accessories for enhanced operation of your Multifunction card, you can then begin the Installation procedures. Figure 1-1 on the next page provides a concise flow chart to give users a broad picture of the software and hardware installation procedures:

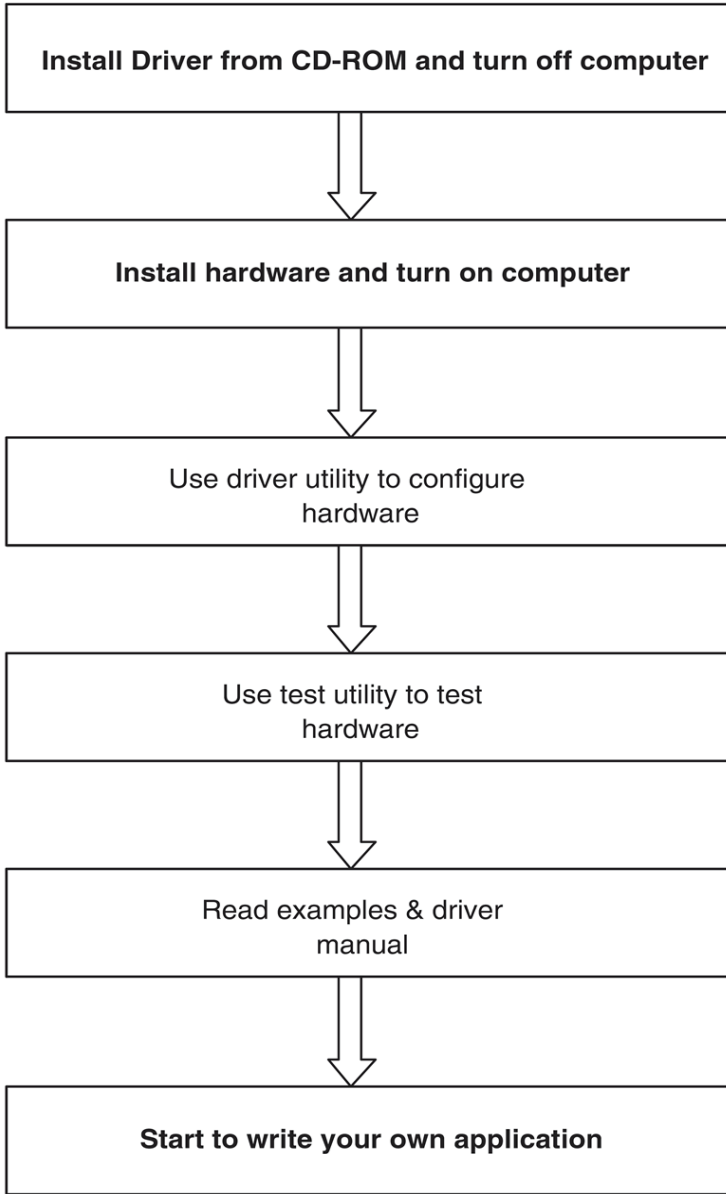

Figure 1.1: Installation Flow Chart

1.5 Software Overview

Advantech offers a rich set of DLL drivers, third-party driver support and application software to help fully exploit the functions of your PCL-818HD/HG/L card:

- Device Drivers (on the companion CD-ROM)
- LabVIEW driver
- Advantech ActiveDAQ
- Advantech GeniDAQ

Programming choices for DA&C cards: You may use Advantech application software such as Advantech Device Drivers. On the other hand, advanced users are allowed another option for register-level programming, although not recommended due to its laborious and time-consuming nature.

Device Drivers

The Advantech Device Drivers software is included on the companion CD-ROM at no extra charge. It also comes with all the Advantech DA&C cards. Advantech's Device Drivers features a complete I/O function library to help boost your application performance. The Advantech Device Drivers for Windows 95/98/NT/2000/ME/XP works seamlessly with development tools such as Visual C++, Visual Basic, Borland C++ Builder and Borland Delphi.

Register-level Programming

Register-level programming is available for experienced programmers who find it necessary to write code directly at the level of the device register. Since register-level programming requires much effort and time, we recommend that you use the Advantech Device Drivers instead. However, if register-level programming is indispensable, you should refer to the relevant information in Appendix C, Register Structure and Format, or to the example codes included on the companion CD-ROM.

1.6 Device Driver Roadmap

This section will provide you a roadmap to demonstrate how to build an application from scratch using Advantech Device Drivers with your favorite development tools such as Visual C++, Visual Basic, Delphi and C++ Builder. The step-by-step instructions on how to build your own applications using each development tool will be given in the Device Drivers Manual. Moreover, a rich set of example source code is also given for your reference.

Programming Tools

Programmers can develop application programs with their favorite development tools:

- **Visual C++**
- **Visual Basic**
- **Delphi**
- **C++ Builder**

For instructions on how to begin programming works in each development tool, Advantech offers a Tutorial Chapter in the Device Drivers Manual for your reference. Please refer to the corresponding sections in this chapter on the Device Drivers Manual to begin your programming efforts. You can also look at the example source code provided for each programming tool, since they can get you very well oriented.

The Device Drivers Manual can be found on the companion CD-ROM. Alternatively, if you have already installed the Device Drivers on your system, The Device Drivers Manual can be readily accessed through the Start button:

Start/Advantech Automation/Device Manager/Device Driver's Manual

The example source code could be found under the corresponding installation folder such as the default installation path:

\\Program Files\\Advantech\\ADSAPI\\Examples

For information about using other function groups or other development tools, please refer to the Creating Windows 95/NT/2000 Application with Device Drivers chapter and the Function Overview chapter on the Device Drivers Manual.

Programming with Device Drivers Function Library

Advantech Device Drivers offer a rich function library that can be utilized in various application programs. This function library consists of numerous APIs that support many development tools, such as Visual C++, Visual Basic, Delphi and C++ Builder.

According to their specific functions or services, those APIs can be categorized into several function groups:

- Analog Output Function Group
- Digital Input/Output Function Group
- Counter Function Group
- Port Function Group (direct I/O)
- Event Function Group

For the usage and parameters of each function, please refer to the Function Overview chapter in the Device Drivers Manual.

Troubleshooting Device Drivers Error

Driver functions will return a status code when they are called to perform a certain task for the application. When a function returns a code that is not zero, it means the function has failed to perform its designated function. To troubleshoot the Device Drivers error, you can pass the error code to `DRV_GetErrorMessage` function to return the error message. Alternatively, you can refer to the Device Drivers Error Codes Appendix in the Device Drivers Manual for a detailed listing of Error Codes, Error IDs and the Error Messages.

1.7 Accessories

Advantech offers a complete set of accessory products to support the PCL-818HD/HG/L card. These accessories include:

Wiring Cables

- PCL-10120 The PCL-10120 cable is a 20-pin flat cable for PCL-818HD/HG/L cards.
- PCL-10137 The PCL-10137 shielded cable is specially designed for PCL-818HD/HG/L cards to provide high resistance to noise. To achieve a better signal quality, the signal wires are twisted in such a way as to form a “twisted-pair cable”, reducing cross-talk and noise from other signal sources. Furthermore, its analog and digital lines are separately sheathed and shielded to neutralize EMI/EMC problems.

Wiring Boards

- ADAM-3920 20-pin wiring terminal for DIN-rail mounting
- ADAM-3937 37-pin D-type wiring terminal for DIN-rail mounting
- PCLD-7216 16-channel SSR I/O module carrier board
- PCLD-780 Universal screw-terminal board
- PCLD-782 16-channel opto-isolated D/I board
- PCLD-782B 24-channel opto-isolated D/I board
- PCLD-785 16-channel relay output board
- PCLD-785B 24-channel relay output board
- PCLD-786 8-channel SSR I/O module carrier board
- PCLD-788 16-channel relay multiplexer board
- PCLD-789D Amplifier and multiplexer board
- PCLD-880 Universal screw-terminal board
- PCLD-885 16-channel power relay output board
- PCLD-8115 Industrial wiring terminal with CJC circuit

Installation

Sections include:

- Unpacking
- Driver Installation
- Hardware Installation
- Device Setup & Configuration

Chapter 2 Installation

2.1 Unpacking

After receiving your PCL-818HD/HG/L package, please inspect its contents first. The package should contain the following items:

- PCL-818HD/HG/L card
- Companion CD-ROM (Device Drivers included)
- User's Manual

The PCL-818HD/HG/L card harbors certain electronic components vulnerable to electrostatic discharge (ESD). ESD can easily damage the integrated circuits and certain components if preventive measures are ignored.

Before removing the card from the antistatic plastic bag, you should take the following precautions to ward off possible ESD damage:

- Touch the metal part of your computer chassis with your hand to discharge the static electricity accumulated on your body. Alternatively, one can also use a grounding strap.
- Touch the anti-static bag to a metal part of your computer chassis before opening the bag.
- Take hold of the card only by the metal bracket when removing it out of the bag.

After taking out the card, you should first:

- Inspect the card for any possible signs of external damage (loose or damaged components, etc.). If the card is visibly damaged, please notify our service department or our local sales representative immediately. Do not install a damaged card into your system.

Note: *Keep the anti-static bag for future use. You might need the original bag to store the card if you have to remove the card from PC or transport it elsewhere.*

2.2 Driver Installation

We recommend you to install the driver before you install the PCL-818HD/HG/L card into your system, since this will guarantee a smooth installation process.

The Advantech Device Drivers Setup program for the PCL-818HD/HG/L card is included in the companion CD-ROM that is shipped with your DA&C card package. Please follow the steps below to install the driver software:

Step 1: Insert the companion CD-ROM into your CD-ROM drive.

Step 2: The Setup program will be launched automatically if you have the autoplay function enabled on your system. When the Setup Program is launched, you will see the following Setup Screen.

Note: *If the autoplay function is not enabled on your computer, use Windows Explorer or Windows Run command to execute SETUP.EXE on the companion CD-ROM.*



Figure 2.1: Advantech Automation Software Setup

Step 3: Select the Device Drivers option.

Step 4: Select the specific device then just follow the installation instructions step by step to complete your device driver installation and setup.

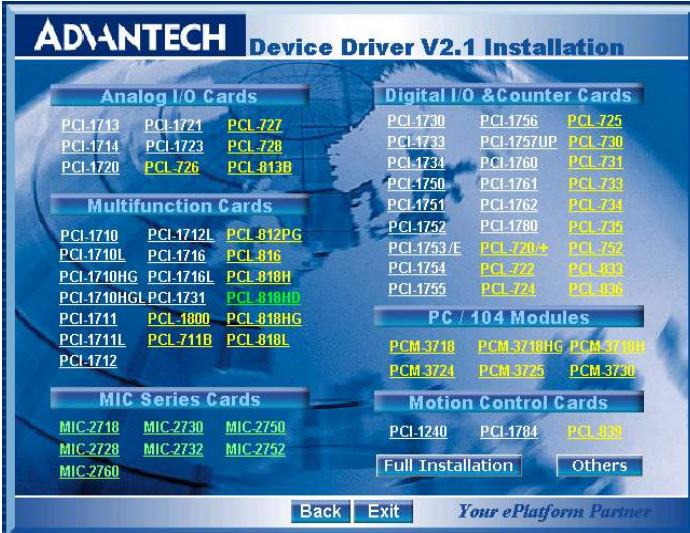

Figure 2.2: Options for Driver Setup

For further information on driver-related issues, an online version of the Device Drivers Manual is available by accessing the following path:

Start/Advantech Automation/Device Manager/Device Driver's Manual

2.3 Hardware Installation

Note: Make sure you have installed the driver first before you install the card (please refer to 2.2 Driver Installation)

After the Device Drivers installation is completed, you can then install the PCL-818HD/HG/L card into any PCI slot on your computer. However, it is suggested that you refer to the computer user's manual or related documentation if you have any doubt. Please follow the steps below to install the card onto your system.

Step 1: Turn off your computer and unplug the power cord and cables. **TURN OFF** your computer before installing or removing any components on the computer.

Step 2: Remove the cover of your computer.

Step 3: Remove the slot cover on the back panel of your computer.

Step 4: Touch the metal part on the surface of your computer to neutralize the static electricity that might be on your body.

Step 5: Insert the PCL-818HD/HG/L card into an ISA slot. Hold the card only by its edges and carefully align it with the slot. Insert the card firmly into place. Use of excessive force must be avoided; otherwise, the card might be damaged.

Step 6: Fasten the bracket of the ISA card on the back panel rail of the computer with screws.

Step 7: Connect appropriate accessories (37-pin cable, wiring terminals, etc. if necessary) to the ISA card.

Step 8: Replace the cover of your computer chassis. Reconnect the cables you removed in step 2.

Step 9: Plug in the power cord and turn on the computer.

After your card is properly installed on your system, you can now configure your device using the Advantech Device Manager Program that has itself already been installed on your system during driver setup. A complete device installation procedure should include device setup, configuration and testing. The following sections will guide you through the Setup, Configuration and Testing of your device.

2.4 Device Setup & Configuration

The Advantech Device Manager program is a utility that allows you to set up, configure and test your device, and later stores your settings on the system registry. These settings will be used when you call the APIs of Advantech Device Drivers.

Setting Up the Device

Step 1: To install the I/O device for your card, you must first run the Device Installation program (by accessing Start/Advantech Automation/Device Manager/Advantech Device Manager).

Step 2: You can then view the device(s) already installed on your system (if any) on the Installed Devices list box. Since you have not installed any device yet, you might see a blank list such as the one below (Fig. 2-3).

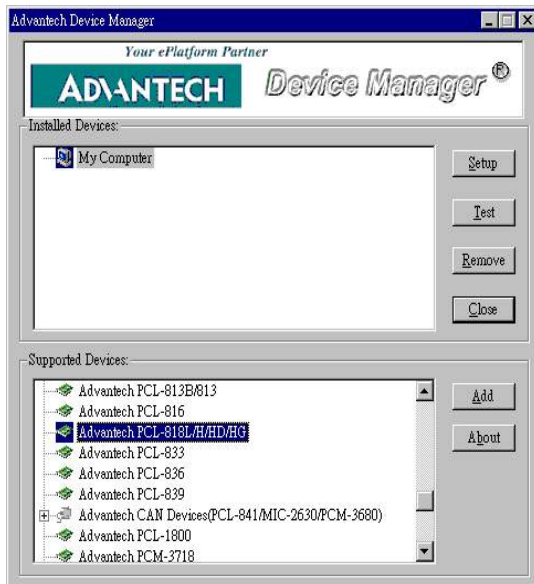

Figure 2.3: Device Manager

Step 3: Scroll down the List of Devices box to find the device that you wish to install, then click the Add... button. You will see a Device Setting dialog box such as the one in Fig. 2-4.

Configuring the Device

Step 4: On the Device Setting dialog box (Fig. 2-4), you can configure the A/D channels configuration either as 8 Differential or 16 Single-ended, and specify the D/A voltage reference either as External or Internal.

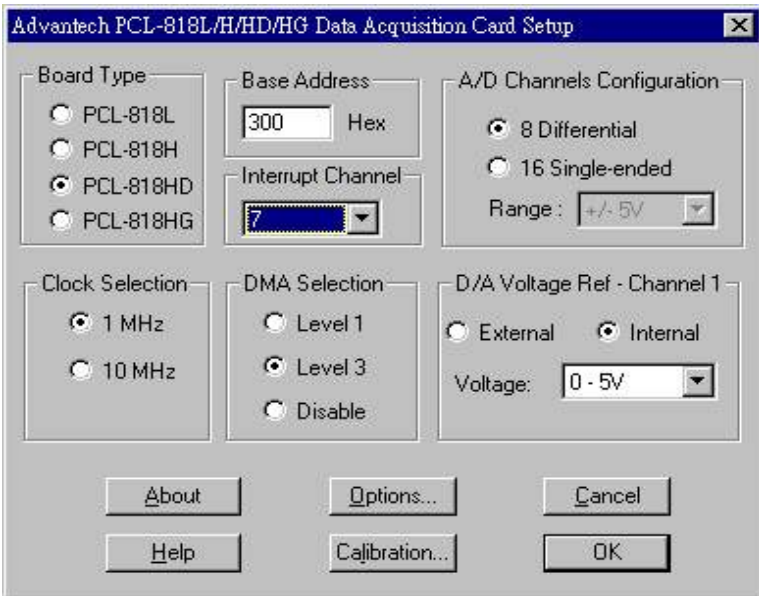

Figure 2.4: Device Settings

Step 5: After you have finished configuring the device, click OK and the device name will appear in the Installed Devices box as seen below:

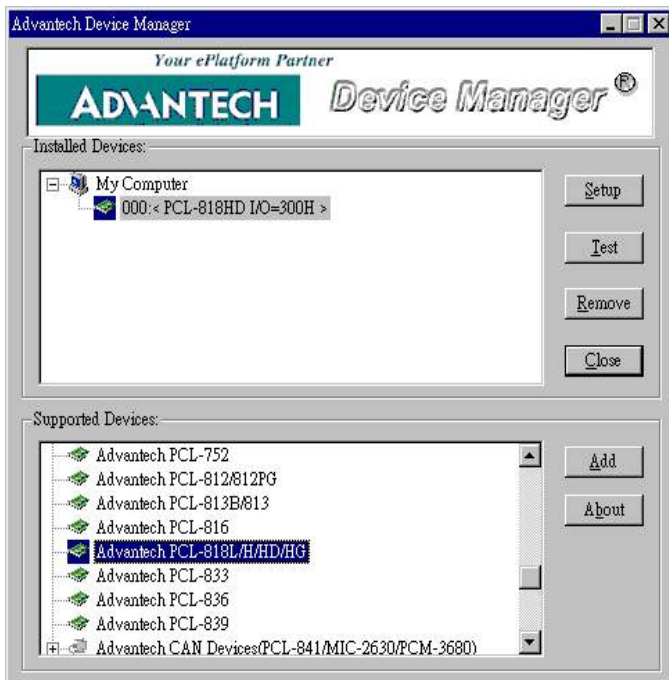

Figure 2.5: Device Name

After your card is properly installed and configured, you can click the Test... button to test your hardware by using the testing utility supplied.

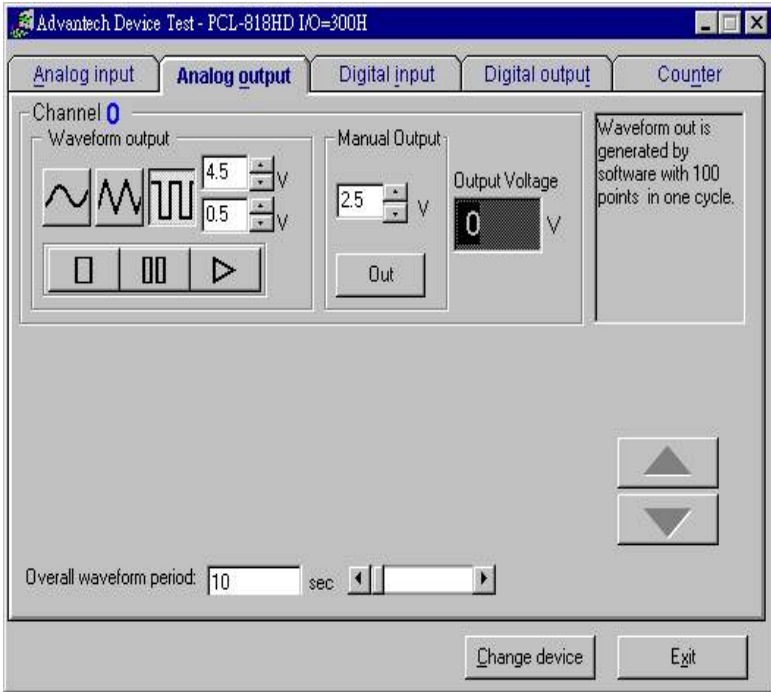

Figure 2.6: Test Utility

For more detailed information, please refer to Chapter 2 of the Device Drivers Manual. You can also find the rich examples on the CD-ROM to speed up your programming.

Signal Connections

Sections include:

- Overview
- Switch & Jumper Settings
- Signal Connections
- Field Wiring Considerations

Chapter 3 Signal Connections

3.1 Overview

Maintaining signal connections is one of the most important factors in ensuring that your application system is sending and receiving data correctly. A good signal connection can avoid unnecessary and costly damage to your PC and other hardware devices. This chapter provides useful information about how to connect input and output signals to the PCL-818HD/HG/L via the I/O connector.

3.2 Switch & Jumper Settings

The PCL-818HD/HG/L card has one function switch and five jumper settings.

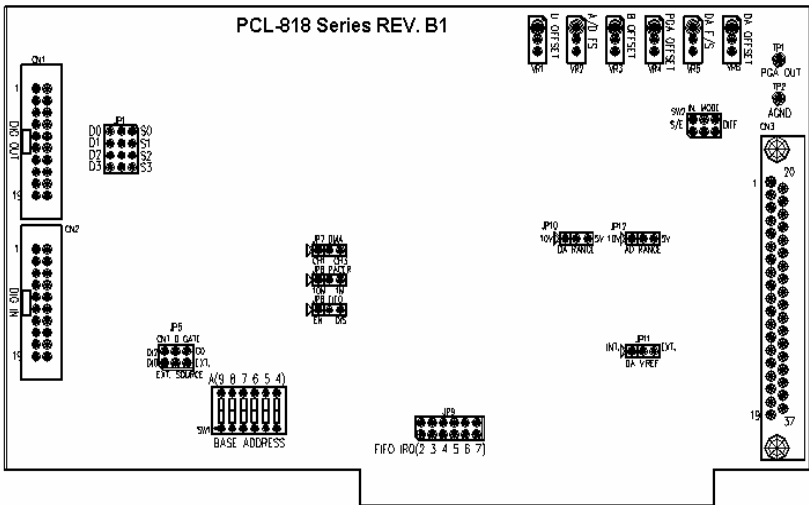

Figure 3.1: Connectors, Jumpers & Switches

Base Address Selection (SW1)

You control the PCL-818HD/HG/L's operation by reading or writing data to the PC's I/O (input/output) port addresses. The PCL-818HD/HG/L requires 32 consecutive address locations with the FIFO buffer enabled or 16 locations with the FIFO disabled.

Switch SW1 sets the card's base (beginning) address. Valid base addresses range from Hex 000 to Hex 3F0. Other devices in your system may, however, be using some of these addresses.

We set the PCL-818HD/HG/L for a base address of Hex 300 at the factory. If you need to adjust it to some other address range, set switch SW1 as shown in the following table:

Cable I/O addresses, FIFO disabled (SW1)						
Range (Hex)	Switch position					
	1	2	3	4	5	6
000-00F	●	●	●	●	●	●
010-01F	●	●	●	●	●	○
...						
200-20F	○	●	●	●	●	●
210-21F	○	●	●	●	●	○
...						
*300-30F	○	○	●	●	●	●
...						
3F0-3FF	○	○	○	○	○	○

○=Off ●=On *=default



Note: *Switches 1-6 control the PC bus address lines as follows:*

Switch	1	2	3	4	5	6
Line	A9	A8	A7	A6	A5	A4

Channel Configuration, S/E or DIFF (SW2)

The PCL-818HD/HG/L offers 16 single-ended or eight differential analog input channels. Slide switch SW2 changes the channels between single-ended or differential input. Slide the switch to the left-hand position, marked DIFF, for eight differential inputs (the default) or to the right-hand position, marked S/E, for 16 single-ended inputs.



Table 3-1: Switch SW2 Settings

Switches	Function Description	
SW2		Differential (default)
		Single-ended

DMA Channel Selection (JP7)

The PCL-818HD/HG/L supports DMA data transfer. Jumper JP7 selects the DMA channel 1 or 3.



Table 3-2: Jumper JP7 Settings

Jumpers	Function Description	
JP7		Channel 3 (default)
		Channel 1

D/A Reference Voltage, Int./Ext. (JP11)

Jumper JP11 selects reference voltage source for the PCL-818HD/HG/L's D/A converters. You can use the card's internal reference or supply an external reference.

Table 3-3: Jumper JP11 Settings

Jumpers	Function Description	
JP11		External
		Internal (default)

When you set JP11 to INT, the D/A converter takes its reference voltage input from the card's on-board reference. Jumper JP10 selects either -5 V or -10 V on-board reference voltage. With JP11 set to INT the D/A channel has an output range of 0 to +5 V or 0 to +10 V, respectively.

When you set JP11 to EXT, the D/A converter takes its reference voltage input from pin 31 of connector CN3. You can apply any voltage between -10 V and +10 V to this pin to function as the external reference. The reference input can be either DC or AC (<100 KHz).

When you use an external reference with voltage V_{ref} you can program the D/A channel to output from 0 V to $-V_{ref}$, you can also use the D/A converter as a programmable attenuator. The attenuation factor between reference input and analog output is:



$$\text{Attenuation factor} = G / 4095$$

Where G is a value you write to the D/A registers between 0 and 4095. For example, if you set G to 2048, then the attenuation factor is 0.5. A sine wave of 10 V amplitude applied to the reference input will generate a sine wave of 5 V amplitude on the analog output.

Internal Voltage Reference, -10 V or -5 V (JP10)

If you use an internal reference voltage (set with JP11), the PCL-818HD/HG/L provides a choice of DC internal reference voltage sources: -5 V and -10 V.

Table 3-4: Jumper JP10 Settings

Jumpers	Function Description	
JP10		5 V (default)
		10 V

Timer Clock Selection (JP8)



The PCL-818HD/HG/L's JP8 controls the input clock frequency for the 8254 programmable clock/timer. You have two choices: 10 MHz and 1 MHz. This lets you generate pacer output frequencies from 2.5 MHz to 0.00023 Hz (71 minutes/pulse).

The following equation gives the pacer rate:

$$\text{Pacer rate} = \text{Fclk} / (\text{Div1} * \text{Div2})$$

Fclk is 1 MHz or 10 MHz, as set by jumper JP8. Div 1 and Div2 are the dividers set in counter 1 and counter 2 in the 8254. See Chapter 8 for more details.

Table 3-5: Jumper JP8 Settings



Jumpers	Function Description	
JP8		1 MHz (default)
		10 MHz

FIFO Enable/Disable (JP6)

When you enable the PCL-818HD/HG 's FIFO (First In First Out) buffer, each time the card makes an A/D reading, it will store the data in both the A/D output registers (accessed at addresses BASE+0/1) and in the FIFO buffer (accessed at BASE+23/24). When you enable the FIFO, the PCL-818HD/HG will require 32 consecutive I/O addresses.

When you disable the FIFO buffer, you can only access the converted data from the A/D output registers at BASE+0/1. The PCL-818HD/HG will only require 16 consecutive VO addresses.





Table 3-6: Jumper JP6 Settings

Jumpers	Function Description	
JP6		Disabled
		Enabled (default)

Ext. Trigger and Counter Gate 0 Control (JP5)

JP5 has two jumpers. The upper jumper selects the card's A/D trigger source when you use external triggering. The lower jumper selects the gate control for counter 0 of the card's 8254 timer/counter.

Table 3-7: Jumper Settings

Jumpers	Function Description	
JP5 (Upper)		G0 (default)
		DI2
JP5 (Lower)		Ext. (default)
		DI0

We recommend that you leave JP5 set to the default DIO and DI2, because the software driver requires this setting.

FIFO Interrupt Selection (JP9)

The PCL-818HD/HG's JP9 controls the interrupt (2 through 7) that the FIFO generates when it is half full. The FIFO interrupt control register, BASE+6, enables and disables this interrupt. Jumper settings are as follows:

FIFO IRQ Select (IRQ2 Default)

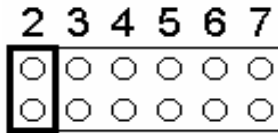









Digital Output, 20-pin or 37-pin Connector (JP1-4)

The PCL-818HD/L's JPI to JP4 switch digital output channels 0 to 3 between the card's 20-pin connector and 37-pin connector. If you set the jumpers to the left (D) side, the digital output signals will come out on connector CN1 (20-pin). If you set the jumpers to the right (S) side, the output signals will come out on connector CN3 (37-pin).

These four digital output signals select the analog input channel when you use a multiplexer/amplifier daughter board. Daughter boards with a DB-37 connector, such as the PCLD-789D, read the digital output signals from the DB-37 connector (CN3). With other daughter boards you will need to connect an external 20-pin flat cable from CN1 to the daughter board.

Table 3-8: Jumper Settings

Jumpers	Function Description	
JP1 (first)		S0
		D0 (default)
JP1 (second)		S1
		D1 (default)
JP1 (third)		S2
		D2 (default)
JP1 (fourth)		S3
		D3 (default)

3.3 Signal Connections

3.3.1 Pin Assignments

Figure 3-2 shows the pin assignments for the 37-pin I/O connector.

CN1			CN2				
D/O 0	1	2	D/O 1	D/I 0	1	2	D/I 1
D/O 2	3	4	D/O 3	D/I 2	3	4	D/I 3
D/O 4	5	6	D/O 5	D/I 4	5	6	D/I 5
D/O 6	7	8	D/O 7	D/I 6	7	8	D/I 7
D/O 8	9	10	D/O 9	D/I 8	9	10	D/I 9
D/O 10	11	12	D/O 11	D/I 10	11	12	D/I 11
D/O 12	13	14	D/O 13	D/I 12	13	14	D/I 13
D/O 14	15	16	D/O 15	D/I 14	15	16	D/I 15
D.GND	17	18	D.GND	D.GND	17	18	D.GND
+5 V	19	20	+12 V	+5 V	19	20	+12 V

CN3 (Single ended)

A/D S0	1	20
A/D S1	2	21
A/D S2	3	22
A/D S3	4	23
A/D S4	5	24
A/D S5	6	25
A/D S6	7	26
A/D S7	8	27
A.GND	9	28
A.GND	10	29
VREF	11	30
S0*	12	31
+12 V	13	32
S2*	14	33
D.GND	15	34
NC	16	35
Counter	17	36
Counter	18	37
+5 V	19	

CN3 (Differential)

A/D H0	1	20	A/D L0
A/D H1	2	21	A/D L1
A/D H2	3	22	A/D L2
A/D H3	4	23	A/D L3
A/D H4	5	24	A/D L4
A/D H5	6	25	A/D L5
A/D H6	7	26	A/D L6
A/D H7	8	27	A/D L7
A.GND	9	28	A.GND
A.GND	10	29	A.GND
VREF	11	30	DA0.OUT
S0*	12	31	DA0.VREF
+12 V	13	32	S1*
S2*	14	33	S3*
D.GND	15	34	D.GND
NC	16	35	EXT.TRIG
Counter	17	36	Counter 0
Counter	18	37	PACER
+5 V	19		

Note: The S0/S1 is NC, and S2/S3 is AGND for PCL-818HG

3.3.2 I/O Connector Signal Description

Table 3-9 I/O Connector Signal Descriptions

Signal Name	Reference	Direction	Description
A/D S <0..15>	A.GND	Input	Analog input (single-ended), channels 0 through 15.
A/D H <0..7>	A.GND	Input	Analog input high (differential), channels 0 through 7.
A/D L <0..7>	A.GND	Input	Analog input low (differential), channels 0 through 7.
D/A	A.GND	Output	Analog output
AGND	-	-	Analog Ground. The two ground references (A.GND and D.GND) are connected together on the PCL-818HD/HG/L card.
D/O	D.GND	Output	Digital output, channels 0 through 15.
D/I	D.GND	Input	Digital input, channels 0 through 15.
CLK	D.GND	Input	Clock input for the 8254.
GATE	D.GND	Input	Gate input for the 8254.
OUT	D.GND	Output	Signal output for the 8254.
VREF	D.GND	Output	Voltage reference.
REFIN	D.GND	Input	External voltage reference input.
S1-S4	D.GND	Output	Daughterboard channel select.
DGND	-	-	Digital Ground. The two ground references (A.GND and D.GND) are connected together on the PCL-818HD/HG/L card.
+12V	D.GND	Output	+12 V _{DC} Source (from ISA bus directly with FUSE protection).
+5V	D.GND	Output	+5 V _{DC} Source (from ISA bus directly with FUSE protection).
NC	-	-	No connection.

Analog Input Connection

The PCL-818HD/HG/L supports either 16 single-ended or 8 differential analog inputs. Switch SW2 selects the input channel configuration.

Single-ended Channel Connections

Single-ended connections use only one signal wire per channel. The voltage on the line references to the common ground on the card. A signal source without a local ground is called a "floating" source. It is fairly simple to connect a single ended channel to a floating signal source. A standard wiring diagram looks like this:

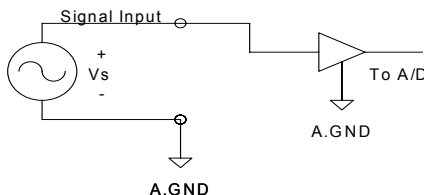

Differential Channel Connections

Differential input connections use two signal wires per channel. The card measures only the voltage difference between these two wires, the HI wire and the LOW wire. If the signal source has no connection to ground, it is called a "floating" source. A connection must exist between LOW and ground to define a common reference point for floating signal sources. To measure a floating sources connect the input channels as shown below:

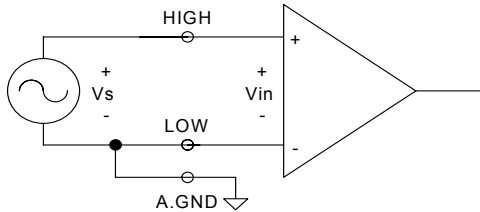

If the signal source has one side connected to a local ground, the signal source ground and the PCL-818HD/HG/L ground will not be at exactly the same voltage, as they are connected through the ground return of the equipment and building wiring. The difference between the ground voltages forms a common-mode voltage.

To avoid the ground loop noise effect caused by common-mode voltages, connect the signal ground to the LOW input. Do not connect the LOW input to the PCL-818HD/HG/L ground directly. In some cases you may also need a wire connection between the PCL-818HD/HG/L ground and the signal source ground for better grounding. The following two diagrams show correct and incorrect connections for a differential input with local ground:

Correct Connection

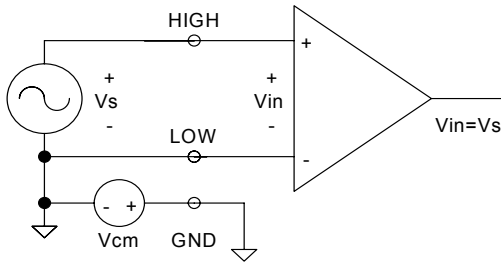

Incorrect Connection

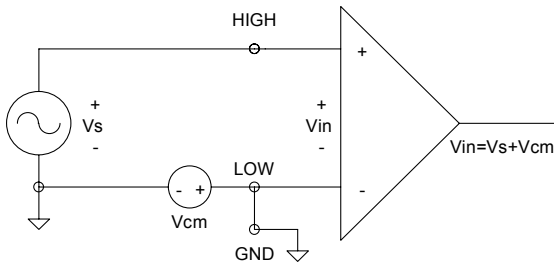

Expanding Analog Inputs

You can expand any or all of the PCL-818HD/HG/L's A/D input channels using multiplexing daughterboards. Daughterboards without D-type connectors require the PCLD-774 Analog Expansion Board.

The PCLD-789(D) Amplifier and Multiplexer multiplexes 16 differential inputs to one A/D input channel. You can cascade up to eight PCLD-789(D)s to the PCL-818HD/HG/L for a total of 128 channels. See the PCLD-789(D) user's manual for complete operating instructions.

The PCLD-774 Analog Expansion Board accommodates multiple external signal-conditioning daughter boards, such as PCLD-779 and PCLD-789(D). It features five sets of on-board 20-pin header connectors. A special star-type architecture lets you cascade multiple signal-conditioning boards without the signal-attenuation and current-loading problems of normal cascading.

The PCLD-8115 Screw Terminal Board makes wiring connections easy. It provides 20-pin flat cable and DB-37 cable connectors. It also includes CJC (Cold Junction Compensation) circuits.

Special circuit pads on the PCLD-8115 accommodate passive signal conditioning components. You can easily implement a low-pass filter, attenuator or current shunt by adding resistors and capacitors.

Analog Output Connection

The PCL-818HD/HG/L provides one D/A output channel. You can use the internal precision -5 V or -10 V reference to generate 0 to +5 V or 0 to +10 V D/A output. Use an external reference for other D/A output ranges. The maximum reference input voltage is ± 10 V and maximum output scaling is ± 10 V. Loading current for D/A outputs should not exceed 5 mA.

Connector CN3 provides D/A signals. Important D/A signal connections such as input reference, D/A outputs and analog ground appear below:

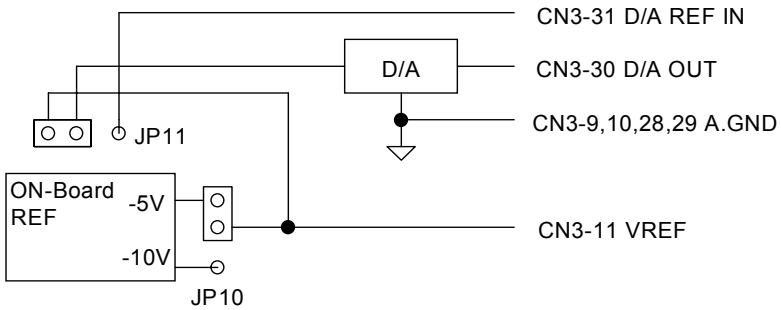
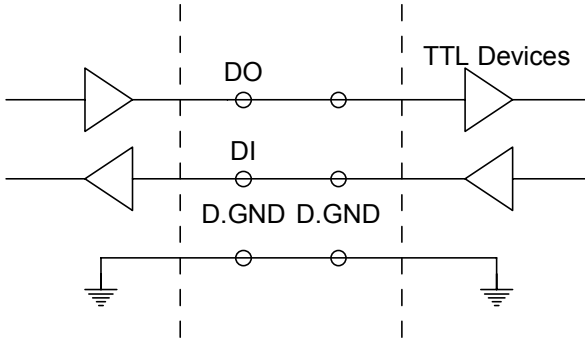

Figure 3.2: Analog Output Connections

Digital Signal Connections

The PCL-818HD/HG/L has 16 digital input and 16 digital output channels. The digital I/O levels are TTL compatible. The following figure shows connections to exchange digital signals with other TTL devices:



To receive an OPEN/SHORT signal from a switch or relay, add a pull-up resistor to ensure that the input is held at a high level when the contacts are open. See the figure below:

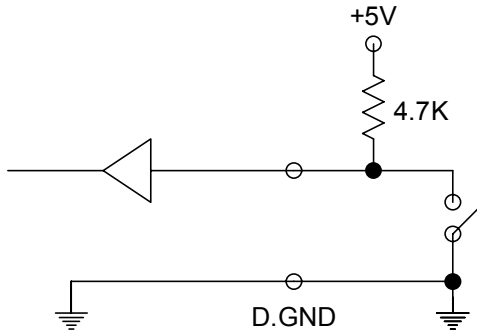

3.4 Field Wiring Considerations

When you use the PCL-818HD/HG/L to acquire data from outside, noises in the environment might significantly affect the accuracy of your measurements if due cautions are not taken. The following measures will be helpful to reduce possible interference running signal wires between signal sources and the PCL-818HD/HG/L.

The signal cables must be kept away from strong electromagnetic sources such as power lines, large electric motors, circuit breakers or welding machines, since they may cause strong electromagnetic interference.

Keep the analog signal cables away from any video monitor, since it can significantly affect a data acquisition system.

If the cable travels through an area with significant electromagnetic interference, you should adopt individually shielded, twisted-pair wires as the analog input cable. This type of cable has its signal wires twisted together and shielded with a metal mesh. The metal mesh should only be connected to one point at the signal source ground.

Avoid running the signal cables through any conduit that might have power lines in it.

If you have to place your signal cable parallel to a power line that has a high voltage or high current running through it, try to keep a safe distance between them. Alternatively, you can place the signal cable at a right angle to the power line to minimize the undesirable effect.

The signals transmitted on the cable will be directly affected by the quality of the cable. In order to ensure better signal quality, we recommend that you use the PCL-10137 shielded cable.

APPENDIX
A

Specifications

Appendix A Specifications

A.1 Analog Input

Channels	16 single-ended or 8 differential or combination										
Resolution	12-bit										
FIFO Size	4K samples (for PCL-818HD/HG only)										
PCL-818HD Max. Sampling Rate ¹	100 KS/s										
PCL-818HG Max. Sampling Rate	Gain	0.5, 1	5, 10	50, 100	500, 1000						
	Speed	100 KS/s	35 KS/s	7 KS/s	770 S/s						
PCL-818L Max. Sampling Rate ¹	40 KS/s										
Conversion Time	8 μ s										
Input range and Gain List for PCL-818HD	Gain	0.5	1	2	4	8					
	Unipolar	N/A	0~10	0~5	0~2.5	0~1.25					
	Bipolar	± 10	± 5	± 2.5	± 1.25	± 0.625					
Input range and Gain List for PCL-818HG	Gain	0.5	1	5	10	50	100	500	1000		
	Unipolar	N/A	0~10	N/A	0~1	N/A	0~0.1	N/A	0~0.01		
	Bipolar	± 10	± 5	± 1	± 0.5	± 0.1	± 0.05	± 0.01	± 0.005		
Input range and Gain List for PCL-818L	Gain	0.5	1	2	4	8					
	Bipolar	± 10	± 5	± 2.5	± 1.25	± 0.625					
Drift	Gain	1	2	4	8	16					
	Zero (V/)	15	15	15	15	15					
	Gain (ppm//)	25	25	25	30	40					
Small Signal Bandwidth for PGA	Gain	1	2	4	8	16					
	Bandwidth	4.0	2.0 MHz	1.5 MHz	0.65	0.35 MHz					
Common mode voltage	± 11 V max. (operational)										
Max. Input voltage	± 15 V										
Input Protect	30 Vp-p										
Input Impedance	1 G/5 pF										
Trigger Mode	Software, onboard Programmable Pacer or External										
PCL-818HD/L Accuracy	DC	INLE: ± 1 LSB									
		Monotonicity: 12 bits									
		Offset error: Adjustable to zero									
		Gain	0.5	1	2	4	8				
		Gain error (% FSR)	0.01	0.01	0.02	0.02	0.04				
	Ch Type	S.E./D	S.E./D	S.E./D	D	D					
	AC	SNR: 68 dB									
PCL-818HG Accuracy	DC	INLE: ± 1 LSB									
		Monotonicity: 12 bits									
		Offset error: Adjustable to zero									
		Gain	0.5, 1	5, 10	50, 100	500	1000				
		Gain error (% FSR)	0.01	0.02	0.04	0.08	0.08				
	Ch Type	S.E./D	S.E./D	D	D	D					
	AC	SNR: 68 dB									
		ENOB: 11 bits									
External TTL Trigger Input	Low	0.4 V max.									
	High	2.4 V min.									

A.2 Analog Output

Channels	1	
Resolution	12-bit	
Output Range (Internal & External Reference)	Using Internal Reference	0 ~ +5V, 0 ~ +10 V
	Using External Reference	-10V ~ +10 V
Accuracy	Relative	±0.5 LSB
	Differential Non-linearity	±0.5 LSB (monotonic)
Gain Error	Adjustable to zero	
Slew Rate	10V/s	
Drift	40 ppm/	
Driving Capability	3 mA	
Max. Update Rate	100 K samples/s	
Output Impedance	0.81 (min.)	
Digital Rate	5 MHz	
Settling Time	26s (to ±1/2 LSB of FSR)	
Reference Voltage	Internal	-5 V ~ + 5 V
	External	-10 V ~ + 10 V

A.3 Digital Input /Output

Input Channels	16 bits	
Level	TTL compatible	
Input Voltage	Low	0.8 V max.
	High	2.0 V min.
Output Channels	16 bits	
Level	TTL compatible	
Output Voltage	Low	0.5 V max. @ +8 mA (sink)
	High	2.4 V min. @ -0.4 mA (source)

A.4 Counter/Timer

Device	Intel 8254 or equivalent
Channels	3 channels, 16 bits. 2 channels are permanently configured as programmable pacers; 1 channel is free for your application
Compatibility	TTL/CMOS
Base Clock	Channel 2: Takes input from output of channel 1 Channel 1: 10 MHz or 1MHz, switch selectable Channel 0: Internal 100 KHz or external clock (10 MHz max.), selected by software
Pacer output	0.00023 Hz (71 minutes/pulse) to 2.5 MHz

A.5 General

I/O Connector Type	DB-37 female x 1, 20-pin connector x 2	
Dimensions	185 mm x 100 mm (7.3" x 3.9")	
Power Consumption	Typical	+5 V @ 650 mA
Temperature	Max. Operation	+5 V @ 700 mA 0 ~ 60 °C (32 ~158°F) (refer to IEC 68-2-1,2)
	Storage	-20~85°C (-4~185°F)
Relative Humidity	5~95%RH non-condensing (refer to IEC 68-2-3)	
Certification	CE certified	

APPENDIX

B

Block Diagram

Appendix B Block Diagram

B.1 PCL-818HD/HG

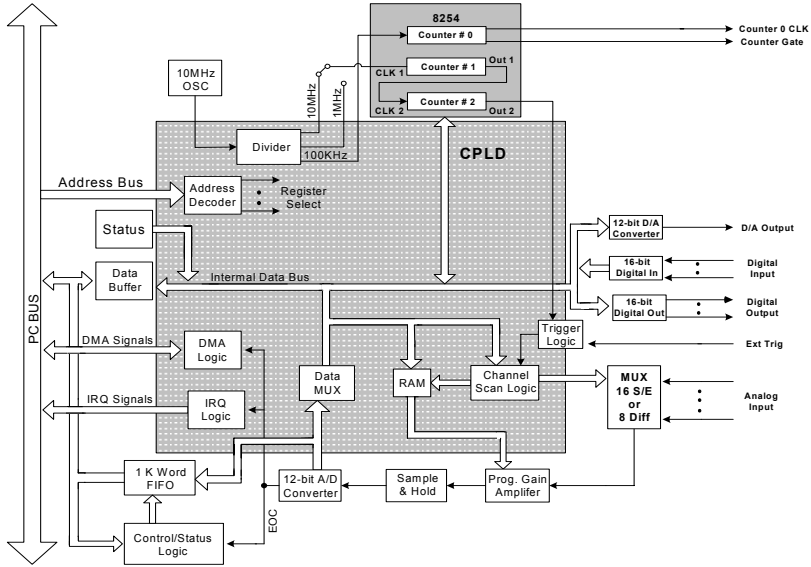

B.2 PCL-818L

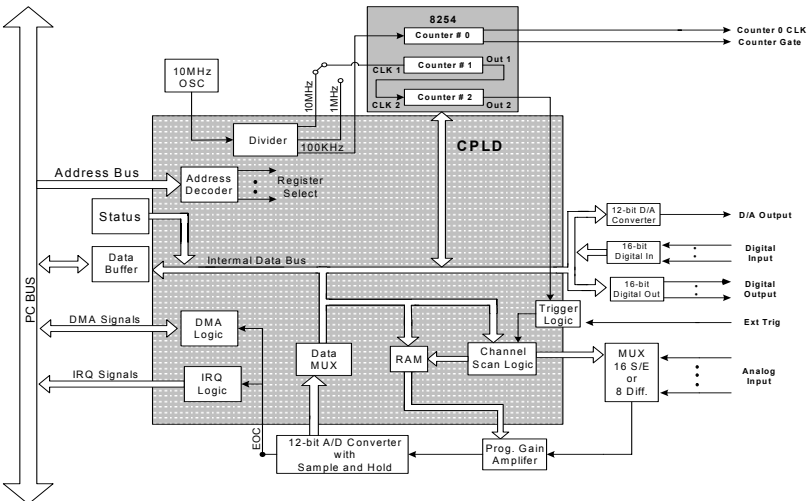

APPENDIX

C

Register Structure & Format

Appendix C Register Structure & Format

C.1 Overview

The PCL-818HD/HG/L is delivered with an easy-to-use 32-bit Device Drivers for user programming under the Windows 95/98/NT/2000/ME/XP operating system. We advise users to program the PCL-818HD/HG/L using the 32-bit Device Drivers provided by Advantech to avoid the complexity of low-level registry programming.

The most important consideration in programming the PCL-818HD/HG/L the register level is to understand the function of the card's registers. The information in the following sections is provided only for users who would like to do their own low-level programming.

C.2 I/O Port Address Map

The PCL-818HD/HG/L requires 32 consecutive addresses in the PC's I/O space. The address of each register is specified as an offset from the card's base address. For example, BASE+0 is the card's base address and BASE+7 is the base address plus seven bytes.

Table C-1 shows the function of each register of the PCL-818HD/HG/L or driver and its address relative to the card's base address.

Table C-1 PCL-818HD/HG/L Register Format (Part 1)

Base Addr. +HEX		7	6	5	4	3	2	1	0
00H	R	A/D low byte data and channels							
		AD3	AD2	AD1	AD0	C3	C2	C1	C0
	W	Software A/D trigger							
01H	R	A/D high byte data and channels							
		AD11	AD10	AD9	AD8	AD7	AD6	AD5	AD4
	W	A/D range control							
02H	R	MUX scan channel status							
						CC3	CC2	CC1	CC0
	W	MUX scan channel control							
03H	R	Digital Input (low byte)							
		DI7	DI6	DI5	DI4	DI3	DI2	DI1	DI0
	W	Digital Output (low byte)							
04H	R	N/A							
	W	D/A output data							
05H	R	N/A							
	W	D/A output data							
06H	R	N/A							
	W	FIFO interrupt control							
07H	R	N/A							
									FINT
	W	N/A							
	R								
	W								

Table C-1 PCL-818HD/HG/L Register Format (Part 2)

Base Addr. +HEX		7	6	5	4	3	2	1	0
08H	R	A/D Status							
		EOC	U/B	MUX	INT	CN3	CN2	CN1	CN0
	W	Clear interrupt request							
09H	R	A/D Control							
		INTE	I2	I1	I0		DMAE	ST1	ST0
	W	A/D Control							
		INTE	I2	I1	I0		DMAE	ST1	ST0
0AH	R	N/A							
	W	Timer/Counter Control						TC1	TC0
0BH	R	Digital Input (high byte)							
		DI15	DI14	DI13	DI12	DI11	DI10	DI9	DI8
	W	Digital Output (high byte)							
		DO15	DO14	DO13	DO12	DO11	DO10	DO9	DO8
0CH	R	Counter 0							
	W	Counter 0							
0DH	R	Counter 1							
	W	Counter 1							
0EH	R	Counter 2							
	W	Counter 2							
0FH	R	N/A							
	W	Counter Control							

Table C-1 PCL-818HD/HG/L Register Format (Part 3)

Base Addr. +HEX		7	6	5	4	3	2	1	0
14H	R	N/A							
	W	Clear FIFO Interrupt Request							
17H	R	A/D data and channels from FIFO							
		AD3	AD2	AD1	AD0	C3	C2	C1	C0
	W	N/A							
18H	R	A/D data and channels from FIFO							
		AD11	AD10	AD9	AD8	AD7	AD6	AD5	AD4
	W	N/A							
19H	R	FIFO status							
	W	FIFO clear							
							FF	HF	EF

C.3 A/D Data & Channels — BASE+00H~01H

Table C-2 Register for A/D Data & Channels

Read	A/D Data & Channels							
Bit #	7	6	5	4	3	2	1	0
BASE + 00H	AD3	AD2	AD1	AD0	C3	C2	C1	C0
BASE + 01H	AD11	AD10	AD9	AD8	AD7	AD6	AD5	AD4

AD11 ~ AD0 Analog to digital data

AD0 the least significant bit (LSB) of the A/D data

AD11 the most significant bit (MSB)

C3 ~ C0 A/D channel number from which the data is derived

C0 the least significant bit (LSB) of the channels

C3 the most significant bit (MSB)

C.4 Software A/D Trigger — BASE+00H

You can trigger an A/D conversion from software, the card's on-board pacer or an external pulse. If you select software triggering, a write to the register BASE+00H with any value will trigger an A/D conversion.

Bits 1 and 0 of register BASE+09H select the trigger source. See pages 57 and 58 for BASE+09H register layout and programming information.

Table C-3 Register for Software A/D Trigger

Write	Software A/D trigger							
Bit #	7	6	5	4	3	2	1	0
BASE + 00H	X	X	X	X	X	X	X	X

C.5 A/D RangeControl — BASE+01H

Each A/D channel has its own individual input range, controlled by a range code stored in on-board RAM. If you want to change the range code for a given channel, select the channel as the start channel in register BASE+02H, MUX scan (described in the next section), then write the range code to bits 0 to 3 of BASE+01H.

Table C-4 Register for A/D Range Control

Write	A/D range control							
Bit #	7	6	5	4	3	2	1	0
BASE + 01H	X	X	X	X	G3*	G2*	G1	G0

G3 ~ G0 A/D range control

G0 the least significant bit (LSB) of the A/D range

G3 the most significant bit (MSB)

Range codes appear below:

PCL-818HD					
Input Range (V)	Unipolar/Bipolar	Gain Code			
		G3	G2	G1	G0
-5 to +5	B	0	0	0	0
-2.5 to +2.5	B	0	0	0	1
-1.25 to +1.25	B	0	0	1	0
-0.625 to +0.625	B	0	0	1	1
0 to 10V	U	0	1	0	0
0 to 5V	U	0	1	0	1
0 to 2.5V	U	0	1	1	0
0 to 1.25V	U	0	1	1	1
-10V to +10V	B	1	0	0	0
N/A		1	0	0	1
N/A		1	0	1	0
N/A		1	0	1	1
N/A		1	1	0	0
N/A		1	1	0	1
N/A		1	1	1	0
N/A		1	1	1	1
PCL-818HG					
Input Range (V)	Unipolar/Bipolar	Gain Code			
		G3	G2	G1	G0
±5V	B	0	0	0	0
±0.5V	B	0	0	0	1
±0.05V	B	0	0	1	0
±0.005V	B	0	0	1	1
0 to 10V	U	0	1	0	0
0 to 1V	U	0	1	0	1
0 to 0.1V	U	0	1	1	0
0 to 0.01V	U	0	1	1	1
±10V	B	1	0	0	0
±1V	B	1	0	0	1
±0.1V	B	1	0	1	0
±0.01V	B	1	0	1	1
N/A		1	1	0	0
N/A		1	1	0	1
N/A		1	1	1	0
N/A		1	1	1	1

PCL-818L			
Input Range		Range Code	
JP7=5V	JP7=10V	G1	G0
±5V	±10V	0	0
±2.5V	±5V	0	1
±1.25V	±2.5V	1	0
±0.625V	±1.25V	1	1

Note: G3 and G2 are not used for PCL-818L.

C.6 MUX Scan Channel Control — BASE+02H

The write register at BASE+02H controls multiplexer (MUX) scanning. The high nibble provides the stop scan channel number, and the low nibble provides the start scan channel number. Writing to this register automatically initializes the MUX to the start channel. Each A/D conversion trigger sets the MUX to the next channel.

With continuous triggering the MUX will scan from the start channel to the end channel, then repeat. For example, if the start channel is 3 and the stop channel is 7, then the scan sequence is 3, 4, 5, 6, 7, 3, 4, 5, 6, 7, 3, 4....

Table C-5 Register for MUX Scan Channel Control

Write	MUX scan channel control							
Bit #	7	6	5	4	3	2	1	0
BASE + 02H	CH3	CH2	CH1	CH0	CL3	CL2	CL1	CL0

CH3 ~ CH0 Stop scan channel number

CH0 the least significant bit (LSB) of the stop channel

CH3 the most significant bit (MSB)

CL3 ~ CL0 Start scan channel number

CL0 the least significant bit (LSB) of the start channel

CL3 the most significant bit (MSB)

The MUX scan register low nibble, CL3 to CL0, also acts as a pointer when you program the A/D input range (see previous section). When you set the MUX start channel to N, the range code written to the register BASE+01H is for channel N.

Programming example for PCL-818HD

This BASIC code fragment sets the range for channel 5 to ± 0.625 V:

```
200 OUT BASE+2, 5 'SET POINTER TO CH.5
```

```
210 OUT BASE+1, 3 'RANGE CODE=3 FOR  $\pm 0.625$  V
```

Note: *The MUX start/stop channel changes each time you change the input range. Do not forget to reset the MUX start and stop channels to the correct values after you finish setting the range.*

C.7 MUX Scan Channel Status — BASE+02H

Read register BASE+02H to get the current multiplexer (MUX) channel.

Table C-6 Register for MUX Scan Channel Status

Read	MUX scan channel status							
Bit #	7	6	5	4	3	2	1	0
BASE + 02H					CC3	CC2	CC1	CC0

CC3 ~ CC0 Current channel number

CC0 the least significant bit (LSB) of the stop channel

CC3 the most significant bit (MSB)

C.8 Digital I/O Registers - BASE + 03/0BH

The PCL-818HD/HG/L provides 16 digital input channels and 16 digital output channels. You read digital input data from registers BASE+03H and BASE+0BH. After the read operation the input lines go to three-state (data is not latched).

You write digital output data to registers BASE+03H and BASE+0BH. The registers latch the output value (you cannot read it back).

Using the PCL-818HD/HG/L's input and output functions is fairly straightforward. Chapter 3 gives some ideas for digital signal connections.

Table C-7 Register for Digital Output

Write	Digital Output							
Bit #	7	6	5	4	3	2	1	0
BASE + 03H	DO7	DO6	DO5	DO4	DO3	DO2	DO1	DO0
BASE + 0BH	DO15	DO14	DO13	DO12	DO11	DO10	DO9	DO8

DO15 ~ DO0 Digital output data

DO0 the least significant bit (LSB) of the DO data

DO15 the most significant bit (MSB)

Table C-8 Register for Digital Output

Read	Digital Input							
Bit #	7	6	5	4	3	2	1	0
BASE + 03H	DI7	DI6	DI5	DI4	DI3	DI2	DI1	DI0
BASE + 0BH	DI15	DI14	DI13	DI12	DI11	DI10	DI9	DI8

DI15 ~ DI0 Digital input data

DI0 the least significant bit (LSB) of the DI data

DI15 the most significant bit (MSB)

Note: Digital Outputs D0 - D3 is selectable from the 20-pin connector or the 37-pin D connector. Please refer to chapter 2 for details.

C.9 D/A Output — BASE+04/05H

Write-only registers BASE+04H and BASE+05H accept data for D/A output.

The PCL-818HD/HG/L provides one D/A output channel with two double-buffered 12-bit multiplying D/A converters. Write registers at addresses BASE+04H and BASE+05H hold output data. DA0 is the least significant bit (LSB) and DA11 is the most significant bit (MSB) of the D/A data.

Table C-9 Register for D/A Output

Write	D/A output data							
Bit #	7	6	5	4	3	2	1	0
BASE + 04H	DA3	DA2	DA1	DA0	X	X	X	X
BASE + 05H	DA11	DA10	DA9	DA8	DA7	DA6	DA5	DA4

DA11 ~ DA0 Analog to digital data

DA0 the least significant bit (LSB) of the D/A data

DA11 the most significant bit (MSB)

When you write data to the D/A channels, write the low byte first. The low byte is temporarily held by a register in the D/A and not released to the output. After you write the high byte, the low byte and high byte are added and passed to the D/A converter. This double buffering process protects the D/A data integrity through a single step update.

The PCL-818HD/HD/L provides a precision fixed internal -5 V or -10 V reference, selectable by means of Jumper JP10. This reference voltage is available at connector CN3 pin 11. If you use this voltage as the D/A reference input, the D/A output range is either 0 to +5 V or 0 to +10 V. You can also use an external DC or AC source as the D/A reference input. In this case, the maximum reference input voltage is ± 10 V, and the maximum D/A output ranges are 0 to +10 V or 0 to -10 V.

Connector CN3 supports all D/A signal connections. Chapter 3 gives connector pin assignments. Chapter 3 gives a wiring diagram for D/A signal connections.

C.10 FIFO Interrupt Control — BASE+06H

Table C-10 Register for FIFO Interrupt Control

Write	FIFO interrupt control							
Bit #	7	6	5	4	3	2	1	0
BASE + 06H	X	X	X	X	X	X	X	FINT

FINT Enable/disable FIFO interrupt

0 FIFO interrupt disabled

FIFO interrupt enabled

Note: This register is not used for PCL-818L.

C.11 Clear Interrupt Request — BASE+08H

Write any value to register BASE+08H to clear the interrupt request.

Table C-11 Register for Clear Interrupt Request

Write	A/D control							
Bit #	7	6	5	4	3	2	1	0
BASE + 09H	X	X	X	X	X	X	X	X

C.12 A/D Status — BASE+08H

Read-only register BASE+08H provides information on the A/D configuration and operation. Including:

- Bipolar or unipolar input for the channel to be converted next
- Single-ended or differential input
- Interrupt status for the channel already converted
- End of conversion for the channel already converted
- Channel to be converted next

Writing to this I/O port with any data value clears its INT bit. The other data bits do not change.

Table C-12 Register for A/D Status

Read	A/D status							
Bit #	7	6	5	4	3	2	1	0
BASE + 08H	EOC	U/B	MUX	INT	CN3	CN2	CN1	CN0

EOC End of Conversion

0 The A/D conversion is idle, ready for the next conversion. Data from the previous conversion is available in the A/D data registers.

1 The A/D converter is busy, implying conversion is in progress.

U/B Unipolar/bipolar mode indicator

0 Bipolar mode

Unipolar mode

Note: *This bit is used for PCL-818L.*

MUX	Single-ended/differential channel indicator
0	8 differential channels
1	16 single-ended channels
INT	Data valid
0	No A/D conversion has been completed since the last time the INT bit was cleared. Values in the A/D data registers are not valid data.
1	The A/D conversion has finished, and converted data is ready. If the INTE bit of the control register (BASE +09H) is set, an interrupt signal will be sent to the PC bus through interrupt level IRQ _n , where n is specified by bits I2, I1 and I0 of the control register. Though the A/D status register is read-only, writing to it with any value will clear the INT bit.
CN3 to CN0	When EOC = 0, these status bits contain the channel number of the next channel to be converted.

Note: *If you trigger the A/D conversion with the on-board pacer or an external pulse, your software should check the INT bit, not the EOC bit, before it reads the conversion data.*

EOC can equal 0 in two different situations: the conversion has completed or no conversion has been started. Your software should therefore wait for the signal INT = 1 before it reads the conversion data. It should then clear the INT bit by writing any value to the A/D status register BASE+08H.

C.13 A/D Control — BASE+09H

Read/write register BASE+09H provides information on the PCL-818HD/HG/L's operating modes.

Table C-13 Register for A/D Control

Read/Write	A/D control							
Bit #	7	6	5	4	3	2	1	0
BASE + 09H	INTE	I2	I1	I0		DMAE	ST1	ST0

INTE Disable/enable generated interrupts

0 Disables the generation of interrupts. No interrupt signal can be sent to the PC bus.

Enables the generation of interrupts. If DMAE = 0 the PCL-818HD/HG/L will generate an interrupt when it completes an A/D conversion. Use this setting for interrupt driven data transfer.

If DMAE = 1 the PCL-818HD/HG/L will generate an interrupt when it receives a T/C (terminal count) signal from the PC's DMA controller, indicating that a DMA transfer has completed. Use this setting for DMA data transfer. The DMA transfer is stopped by the interrupt caused by the T/C signal. See DMAE below.

I2 to I0 Selects the interrupt used by an interrupt or DMA driven data transfer.

Interrupt level	I2	I1	I0
N/A	0	0	0
N/A	0	0	1
IRQ2	0	1	0
IRQ3	0	1	1
IRQ4	1	0	0
IRQ5	1	0	1
IRQ6	1	1	0
IRQ7	1	1	1

Note: Make sure that the IRQ level you choose is not being used by another I/O device.

DMAE Disable/enable DMA transfers
0 Disables DMA transfers
1 Enables DMA transfer. Each A/D conversion initiates two successive DMA request signals. These signals cause the 8237 DMA controller to transfer two bytes of conversion data from the PCL-818HD/HG/L to memory.

Note: You must program the PC's 8237 DMA controller the DMA page register before you set DMAE to 1.

ST1 to ST0 Trigger source

Trigger Source	ST1	ST0
Software trigger	0	X
External trigger	1	0
Pacer trigger	1	1

C.14 Timer/Counter Enable — BASE+0AH

Write register BASE+0AH enables or disables the PCL-818HD/HG/L's timer/counter.

Table C-14 Register for Timer/Counter Enable

Write	Timer/Counter enable							
Bit #	7	6	5	4	3	2	1	0
BASE + 0AH							TC1	TC0

TC0 Disable/enable pacer

0 Pacer enabled

1 Pacer controlled by TRIG0. This blocks trigger pulses sent from the pacer to the A/D until TRIG0 is taken high.

TC1 Counter 0 input source mode

0 Sets Counter 0 to accept external clock pulses

1 Connects Counter 0 internally to a 100 KHz clock source

C.15 Programmable Timer/Counter — BASE+0C~0FH

The four registers located at addresses BASE+0CH, BASE+0DH, BASE+0EH and BASE+0FH are used for the Intel 8254 programmable timer/counter. Please refer to the 8254 product literature for detailed application information.

C.16 Clear FIFO Interrupt Request — BASE+14H

Write any value to this I/O port to clear the FIFO's interrupt request.

Table C-15 Register for Clear FIFO Interrupt Request

Write	Clear FIFO Interrupt Request							
Bit #	7	6	5	4	3	2	1	0
BASE + 14H	X	X	X	X	X	X	X	X

Note: This register is not used for PCL-818L.

C.17 A/D Data and Channel from FIFO - BASE + 17/18H

The PCL-818HD/HG stores data from A/D conversions in a 1 K word First-In First-Out (FIFO) data buffer. Registers at BASE+17H and BASE+18H store the channel number and data. The register at BASE+19H clears the FIFO buffer and sets its empty flag (EF).

Table C-16 Register for A/D Data and Channel from FIFO

Read	A/D data and channels from FIFO							
Bit #	7	6	5	4	3	2	1	0
BASE + 17H	AD3	AD2	AD1	AD0	C3	C2	C1	C0
BASE + 18H	AD11	AD10	AD9	AD8	AD7	AD6	AD5	AD4

AD11 ~ AD0 Analog to digital data

AD0 the least significant bit (LSB) of the A/D data

AD11 the most significant bit (MSB)

C3 ~ C0 A/D channel number from which the data is derived

C0 the least significant bit (LSB) of the channels

C3 the most significant bit (MSB)

Note: This register is not used for PCL-818L.

C.18 FIFO Status — BASE+19H

The register at BASE+19H clears the FIFO buffer and sets its empty flag (EF). The FIFO status register, address BASE+19H, has flags which you can read to determine the current state of the FIFO buffer, including full flag, half-full flag, and empty flag.

Table C-17 Register for FIFO Status

Read	FIFO status							
Bit #	7	6	5	4	3	2	1	0
BASE + 19H						FF	HF	EF

EF	FIFO empty flag
1	FIFO is empty
0	FIFO is not empty
HF	FIFO half-full flag
1	FIFO is half-full or more than half-full
0	FIFO is less than half-full
FF	FIFO full flag
1	FIFO is full
0	FIFO is not full

Note: This register is not used for PCL-818L.

C.19 FIFO Clear — BASE+19H

Writing any value to BASE+19H clears all data in the FIFO and sets the empty flag (EF) to 1.

Table C-18 Register for FIFO Clear

Write	FIFO clear							
Bit #	7	6	5	4	3	2	1	0
BASE + 19H	X	X	X	X	X	X	X	X

Note: This register is not used for PCL-818L.

APPENDIX
D

Calibration

Appendix D Calibration

This chapter provides brief information on PCL-818HD/HG/L calibration. Regular calibration checks are important to maintain accuracy in *data acquisition and control* applications. We provide the calibration program on the companion CD-ROM to assist you in D/A calibration.

Note: If you installed the program to another directory, you can find these programs in the corresponding sub-folders in your destination directory.

The PCL-818HD/HG/L is calibrated at the factory for initial use. However, a recalibration of the analog input and the analog output function every six months is recommended.

These calibration programs make calibration an easy job. With a variety of prompts and graphic displays, these programs will lead you through the calibration and setup procedures, showing you all the correct settings and adjustments.

To perform a satisfactory calibration, you will need a 4½-digit digital multi-meter and a voltage calibrator or a stable, noise-free D. C. voltage source.

Note: Before you calibrate the D/A function, you must turn on the power at least 15 minutes to make sure the DA&C card is already stable.

A calibration program, CALB.EXE, is included on the CD-ROM:

CALB.EXE PCL-818HD/HG/L calibration utility

This calibration utility is designed for the Microsoft DOS environment. Access this program from the default location:

C:\Program Files\Advantech\ADSAPI\Utilities\PCL818

D.1 VR Assignment

The six variable resistors (VRs) on the PCL-818HD/HG/L board help you make accurate adjustment on all A/D and D/A channels. See the figure in Appendix B for help finding the VRs. The following list shows the function of each VR:

VR	Function
VR1	A/D unipolar offset
VR2	A/D full scale
VR3	A/D bipolar offset
VR4	PGA offset
VR5	D/A full scale
VR6	D/A offset

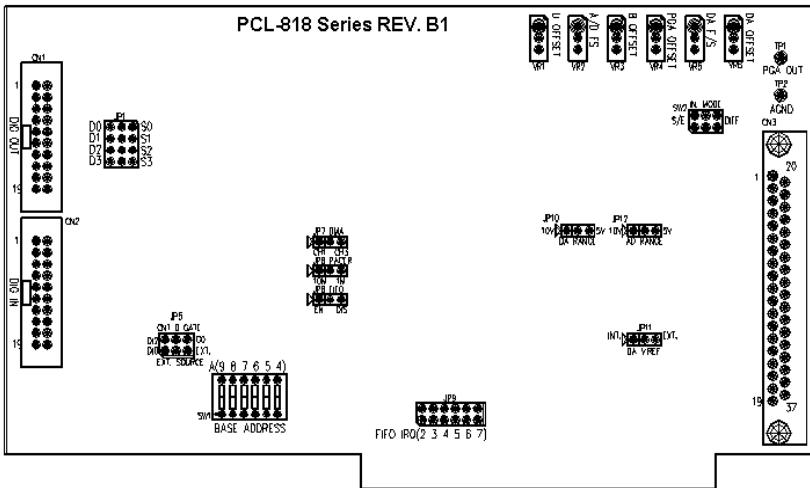

Figure D.1: PCL-818HD/HG/L VR Assignment

D.2 A/D Calibration

Note: Using a precision voltmeter to calibrate the A/D outputs is recommended.

Regular and accurate calibration ensures maximum possible accuracy. The CALB.EXE calibration program leads you through the whole A/D offset and gain adjustment procedure. The basic steps are outlined below:

1. Short the A/D input channel 0 to ground and measure the voltage at TP1 on the PCB (see the figure in Appendix B). Adjust VR4 until TP1 is as close as possible to 0 V.
2. Connect a DC voltage source with value equal to 0.5 LSB (such as the D/A output) to A/D Channel 0 (pin 1 on connector CN3).
3. Adjust VR3 until the output from the card's A/D converter flickers between 0 and 1.
4. Connect a DC voltage source with a value of 4094.5 LSB (such as the D/A output) to A/D channel 0.
5. Adjust VR2 until the A/D reading flickers between 4094 and 4095.
6. Repeat steps 2 to step 5, adjusting VR2 and VR3.
7. Select unipolar input configuration. Connect a DC voltage source with a value of 0.5 LSB (such as the D/A output) to A/D channel 0. Adjust VR1 until the reading of the A/D flickers between 0 and 1.

D.3 D/A Calibration

Note: Using a precision voltmeter to calibrate the D/A outputs is recommended.

Connect a reference voltage within the range ± 10 V to the reference input of the D/A channel you want to calibrate. You can use either the on-board -5 V (-10 V) reference or an external reference. Adjust the full-scale gain and zero offset of the D/A channel with VR5 and VR6, respectively. Use a precision voltmeter to calibrate the D/A output.

Set the D/A data register to 0 and adjust VR6 until the output voltage equals 0 V.

Set the D/A data to 4095 and adjust VR5 until the D/A output voltage equals the reference voltage minus 1 LSB, but with the opposite sign. For example, if V_{ref} is -5 V, then V_{out} should be +4.9988 V.