

Rinnai

Installation and User Manual

RHFE-308 FTR

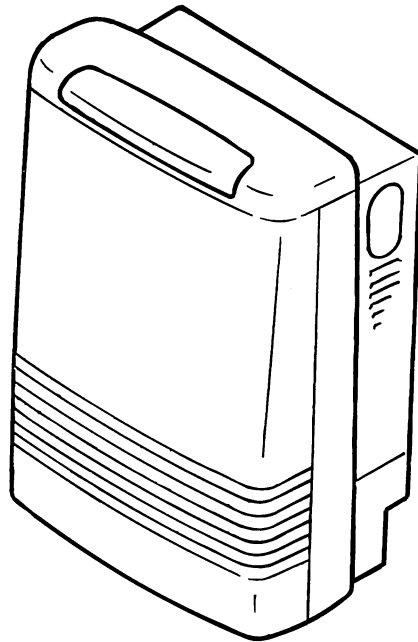

Energysaver Space Heater

Important.

Read these instructions carefully before attempting installation or use of this appliance. All work must be carried out by competent persons.

CONTENTS

Getting to Know your RHFE-308 FTR	3
Remote Control	4
Control Panel Layout	5
Features	6
Safety Points	8
Operating your new RHFE-308 FTR	10
Setting the Clock	14
Pre-heat	17
Override Function	18
Caring for your new RHFE-308 FTR	19
Error Messages	21
Installation Instructions	22
Location	24
Installing the Flue	27
Sleeve and Manifold Installation	29
Flue Extension Kits	32
Conversion	36
Connecting Gas and Electrical Services	37
Testing	38
Gas Pressure Setting	39
Block and Wiring Diagram	42
Dimensions	44
Specification	46
Service Contact	48

GETTING TO KNOW YOUR NEW RHFE-308FTR

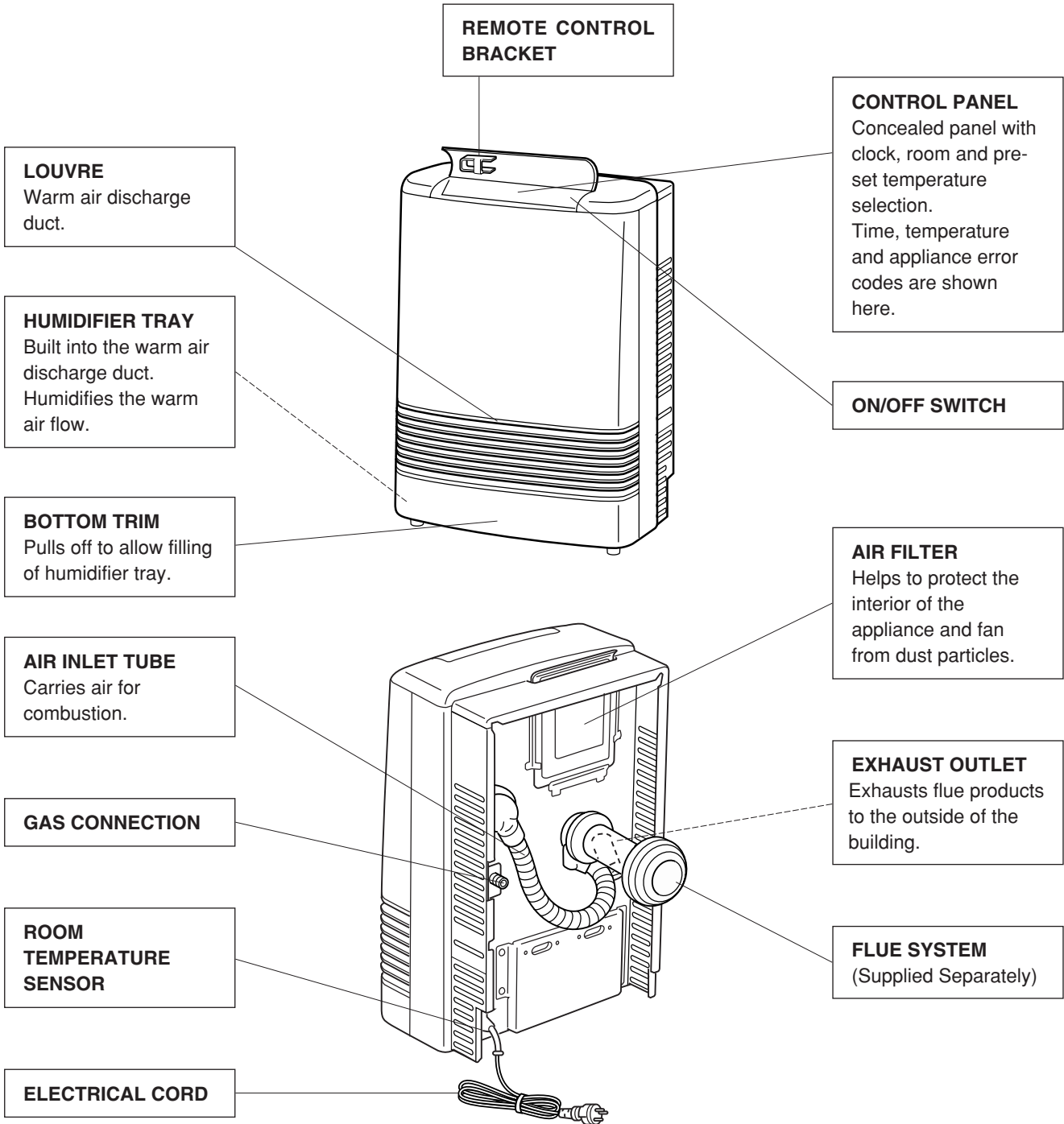

Rinnai Corporation - Japan



ISO 9001
JIS Q 9001

ISO 9001
APPROVED BY JIA



JAB
QMS Accreditation
R004

Manufactured under a Quality System Certified as complying with ISO 9001 by an Accredited Certification Body.



REMOTE CONTROL

TO REPLACE BATTERY
Simply open the back of the remote control and replace Lithium battery.
TYPE: CR 2032

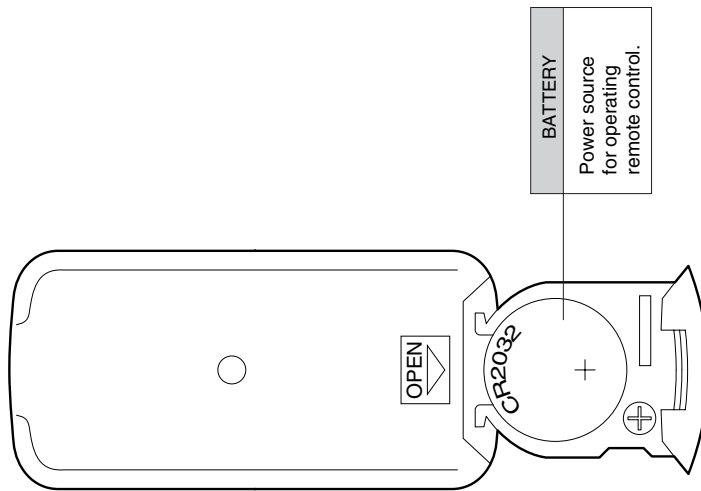

REVERSE

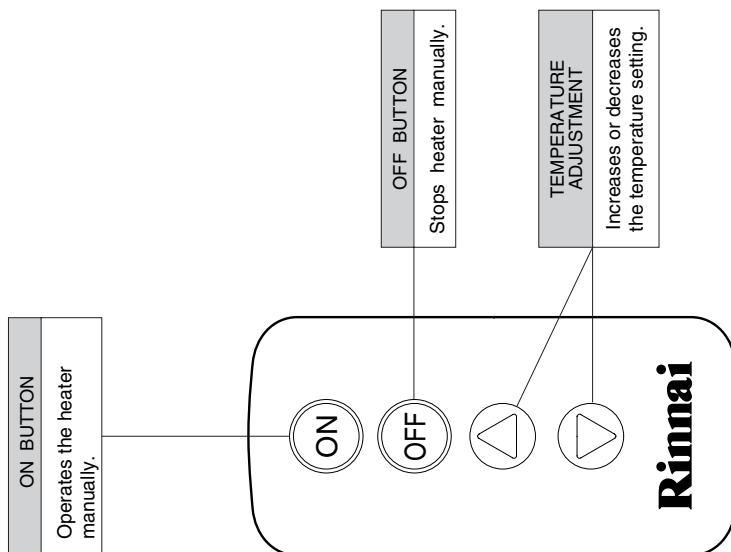

FRONT

■ NOTE

- Some fluorescent lights may interfere with the transmission of remote control signals, in this case changing the position from which you are operating the remote control may help.
- Avoid leaving the remote control in direct sunlight and do not place the remote close to the louvres of the heater.
- Avoid getting the remote control wet, or dropping it.
- The remote control works within 5 metres and an angle of 40° to the receiver on the heater.
- Only use the battery type specified. (CR 2032).
- Remove battery if control is not going to be used for a long period. This will help to avoid damage from leaking batteries.

CONTROL PANEL LAYOUT

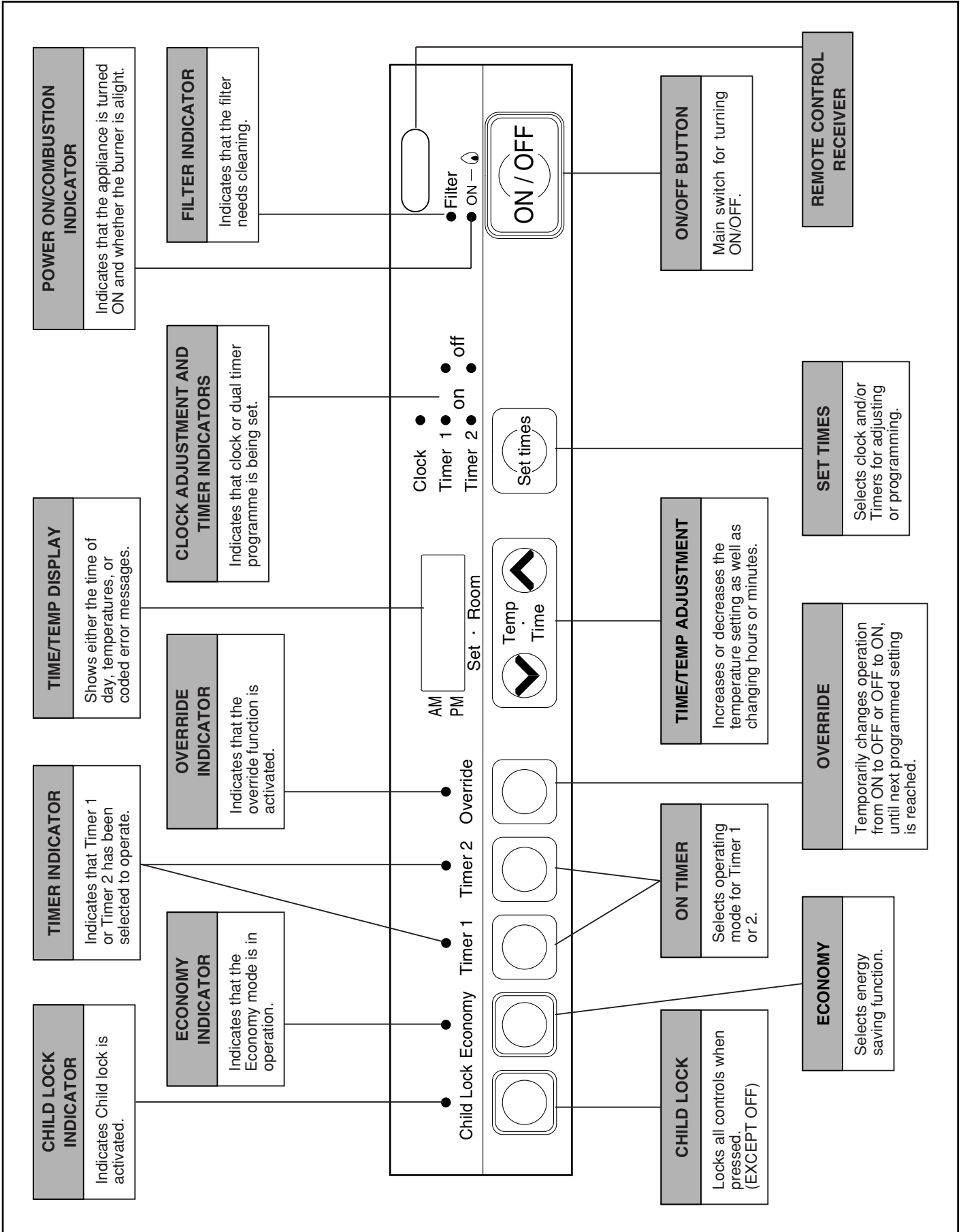

FEATURES

FORCED FLUE SYSTEM

Air for combustion is taken from outside the room and the flue products are exhausted outside, keeping the room air clean.

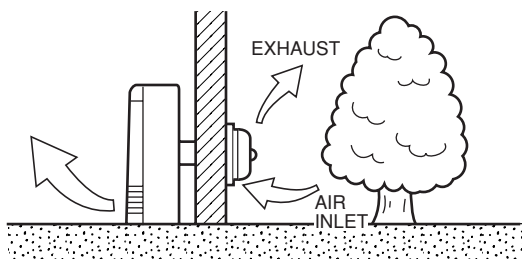

PUSH BUTTON IGNITION

Only one touch of the ON/OFF switch is required to operate the heater.

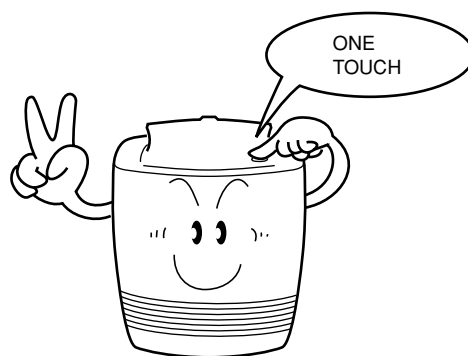

WARM AIR DISCHARGE

Warm air flows from the bottom of the appliance through the louvres, assisting in even heat distribution. An integral humidifier tray is built into the warm air discharge duct.

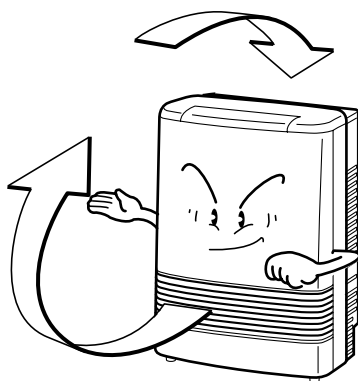

PRE-HEAT

The function will automatically operate the appliance within one hour prior to the programmed time of the Timer. This is designed to heat a room to the pre-set temperature by the programmed time.

DUAL ON/OFF TIMER

The Dual Timer allows you to programme the appliance to come on for two separate periods each day, usually one period in the morning, and one period in the evening. The built in Intelligent Mode brings the room temperature to the temperature you have selected, by the time programmed into the Timer.



The Dual Timer feature means that you can "Set and Forget" your heater. It will turn itself ON and OFF at times you have programmed until you cancel the Timer program.

FILTER INDICATOR

When the fan filter becomes covered with dust and the temperature inside the appliance rises, the filter indicator will flash. The filter should be vacuumed at regular intervals to avoid unnecessary strain on the appliance.

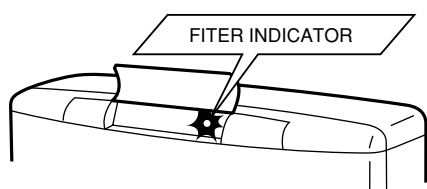

AUTO COMFORT

Ensures that the flow of warm air from the louvres is maintained at a comfortable volume during the warm-up period by a 8 step modulating convection fan, in conjunction with the thermostat, reducing cool draughts.

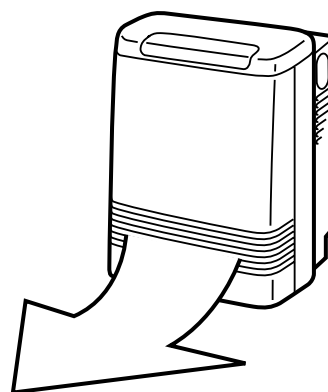

REMOTE CONTROL

For the convenience of turning the heater ON or OFF, as well as adjusting the temperature up or down while at a short distance from the heater.

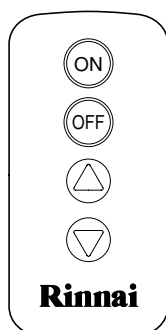

CHILD LOCK

When the Child lock is activated all controls other than the OFF switch will be locked. Deactivating the lock releases the controls. If the lock is activated when the appliance is off, all functions will be locked.

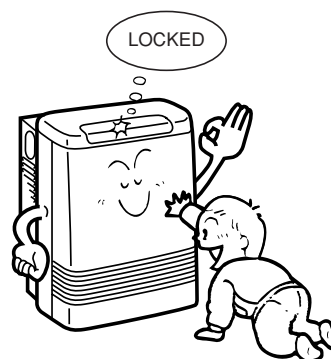

ECONOMY MODE

This is an energy saving feature designed to reduce the room temperature to 1°C less than the pre-set temperature over a period of 30 minutes, and an additional 1°C after another 30 minutes.

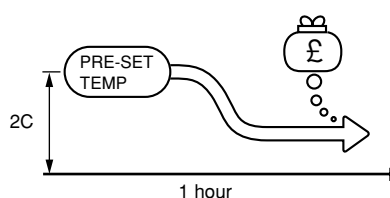

MEMORY

The micro-computer records selected pre-set temperatures, the times programmed into the Timers as well as operating the Economy and Intelligent modes, to maintain comfort levels.

SAFETY POINTS

Do not restrict the warm air discharge by placing articles in front of the heater.

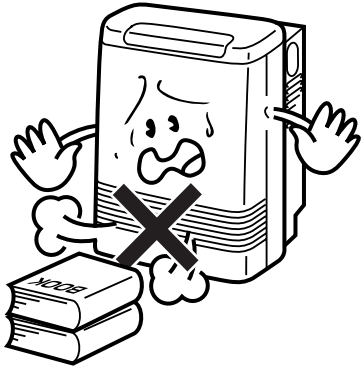

This appliance must not be used for any purpose other than heating.

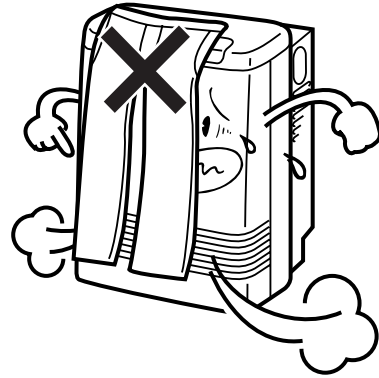

Do not spray aerosols whilst the heater is operating. Most aerosols contain butane gas, and can be a fire hazard if used near this heater when it is in use.

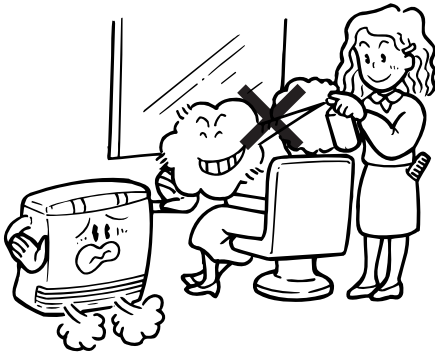

Flue guard is recommended where children may be able to touch the flue terminal.

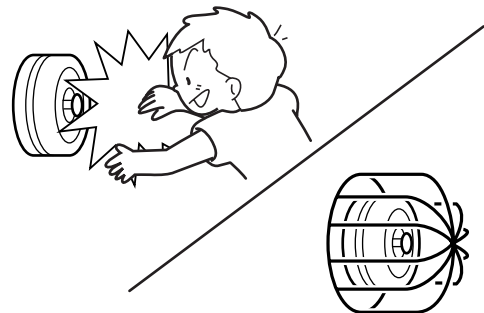

Do not allow curtains or other flammable or combustible materials to come into contact with the heater.

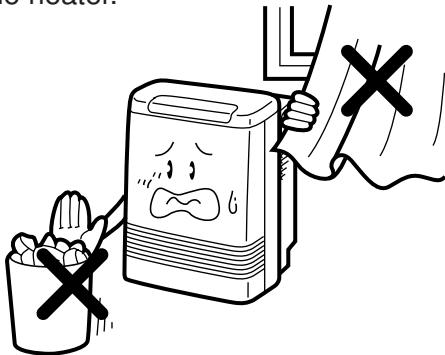

Combustible materials must not be placed where the heater could ignite them.

Do not allow anyone to sit on or lean against the appliance.



SAFETY POINTS

Keep flammable materials, trees, shrubs, etc, away from the flue terminal.

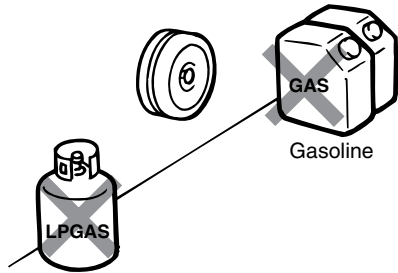

Do not allow anyone to post articles through the louvres.

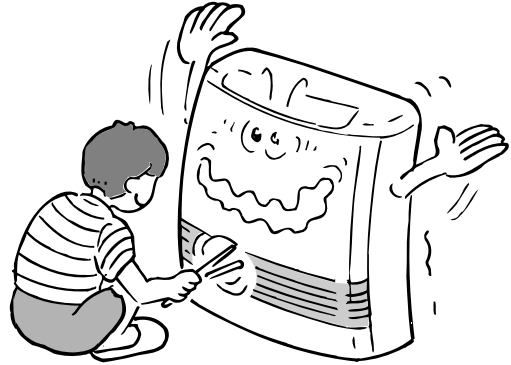

Filter should be cleaned at regular intervals.

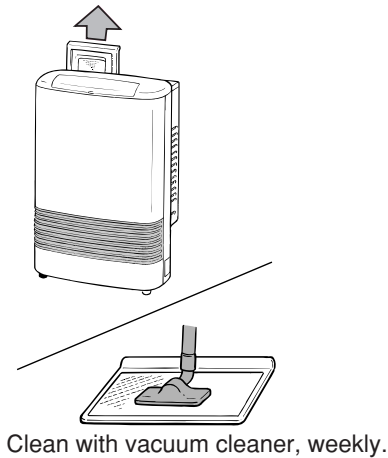

Young children should be supervised at all times. Hand or body contact with the louvres should be avoided.

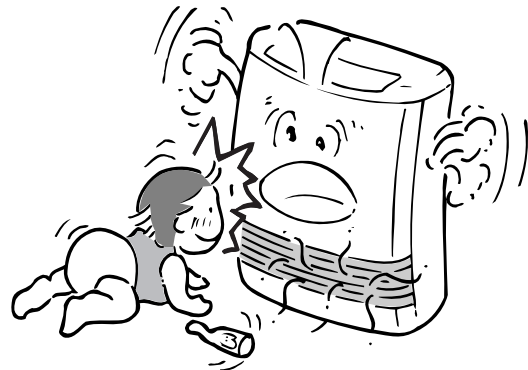

Do not place articles containing liquids on top of the heater. Liquids spilt on the controls may cause extensive damage.

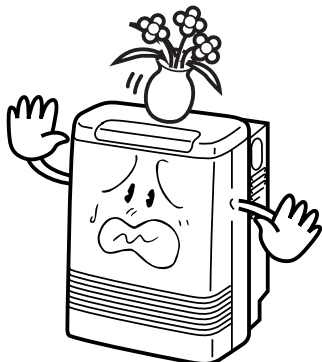

Do not allow young children or the infirm to sleep directly in front of the heater.

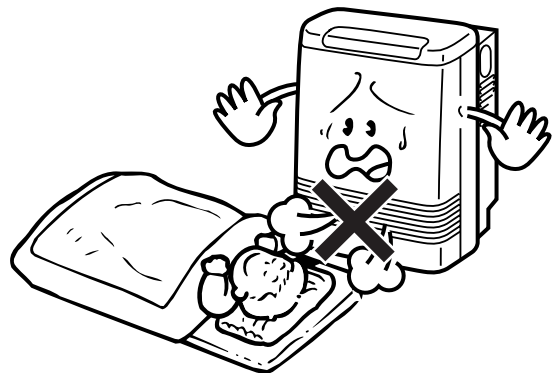

OPERATING YOUR NEW RHFE-308FTR

■ TO OPEN THE CONTROL PANEL

Lift lightly in the centre of the lid where there is a catch. The control panel lid will then drop backward to an angle.

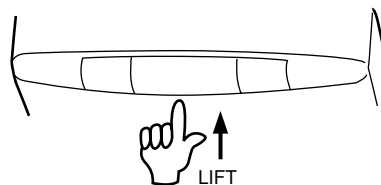

■ TURNING ON

Press the ON/OFF button to operate the heater. The ON indicator will glow green. After approximately 20 seconds the spark generator will be heard before the burner ignites and the ON indicator glows red, indicating that the burner is alight. Warm air can be felt coming from the louvres 15 seconds later.

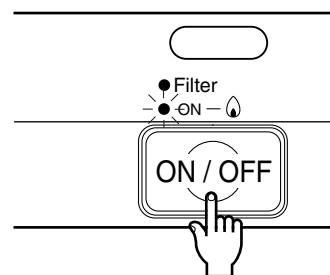

If the heater does not ignite on initial use, this may be due to air remaining in the gas supply line. The spark generator will only continue for 15 seconds. After this it will be necessary to press the ON/OFF button OFF, then ON again.

■ TURNING OFF

Simply press the ON/OFF button to switch off the heater. The ON indicator will go out. The convection fan will continue to operate for several minutes after the burner has gone out in order to cool the appliance. **Do not unplug the appliance while the convection fan is running.**

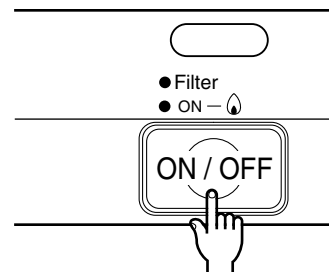

DO NOT turn heater off by unplugging at the power point. The convection fan must continue to run until the appliance cools.

ROOM TEMPERATURE ADJUSTMENT

The room temperature and pre-set temperatures can only be displayed and adjusted when the heater is running.

1

Press the “ \wedge ” button to increase the temperature setting or “ \vee ” button to decrease the temperature setting.

The Temperatures can be preset to:

- a) [L] low (about 10°C)
- b) [16°C] to [26°C] in 1°C steps
- c) [H] (continuously high)

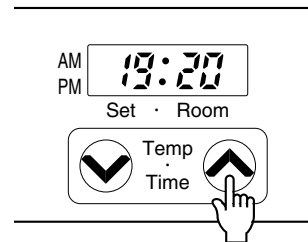

If the heater does not ignite then the pre-set temperature may not be set to a setting which is higher than the room temperature. The ON indicator will change colour from red to green when the heater reaches the pre-set temperature and stops running.

ECONOMY MODE

The Economy mode may only be operated when the heater is turned on, but remains in the system memory once set until deactivated.

Select the Economy mode before selecting time operation.

1

Press the Economy button to start the Economy function. The Economy indicator will glow.

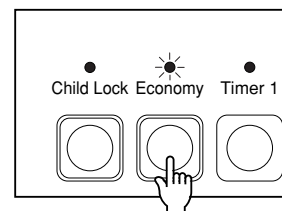

2

Press the Economy button once more to switch off the function.

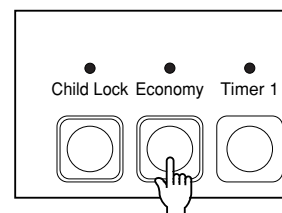

After the room is heated initially the air temperature may be dropped to a lower level without affecting comfort. 30 mins after the selected room temperature (set with the thermostat) is reached, the Economy mode, if set, reduces the temperature by 1°C. After another 30 mins it reduces the temperature by a further 1°C, this is an energy saving feature. The Economy mode does not operate if the heater is under capacity for the room size.

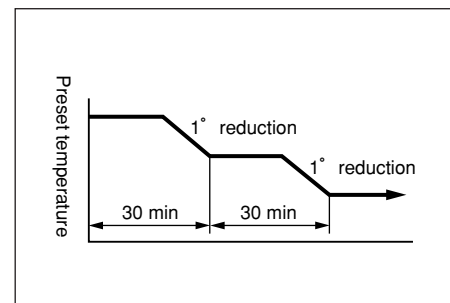

■ CHILD LOCK

The Child lock will help to prevent accidental operation as well as small children from altering the controls.

1

To operate the Child lock simply press the Child Lock button. The function is activated immediately and the Child lock indicator will glow.

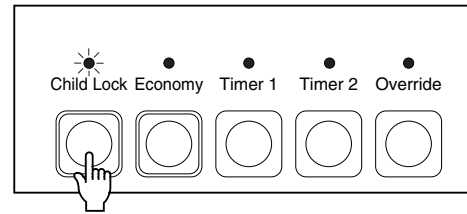

2

To deactivate the Child lock simply press the Child Lock button for 2 seconds and the Child lock indicator will go out. The lock can be deactivated at any time in this way.

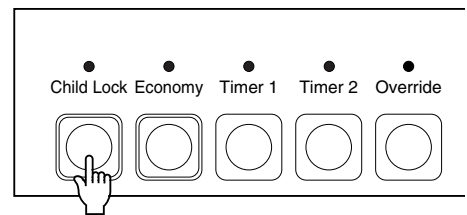

During normal operation the Child lock may be activated and all controls other than the OFF switch will be locked. Deactivating the lock releases the controls. If the lock is activated whilst the heater is turned OFF, then all functions will be locked. If the heater is turned OFF whilst the Child lock is activated, it cannot be turned ON again until the lock is deactivated.

■ AUTO COMFORT

A room temperature sensor located at the rear of the appliance is continuously monitoring the temperature of the room. The main purpose of Auto Comfort is to improve control over the flow of warm air being discharged through the louvres when the heater is first operated. The means by which this control is achieved is a 7 speed modulating convection fan and the temperature sensor, in conjunction with a micro-computer.

In order to achieve comfortable heating, it is preferable to avoid cold draughts from the appliance. In the case of a conventional fan heater, the convection fan operates normally from the time of ignition and a cool draught may accompany the flow of air from the appliance.

To overcome this situation, fuzzy logic controls the speed of the convection fan after taking into consideration the room temperature at the time of ignition. For example: the room temperature is low, then the fan rotates at low speed. As the room temperature rises the speed of the convection fan gradually increases.

In this way it is possible to ensure a comfortable flow of warmed air, as well as decreasing the sensation of cold draughts immediately after ignition.

The convection fan speed increases proportionally as the room gradually heats up. This improves the warm air distribution, assisting in a reduction of warm air stratification throughout the room, and resulting in more effective heating conditions.

The micro computer continuously monitors the room temperature and adjusts the convection fan speed according to the conditions at the time.

■ FAN FILTER

To protect the room air fan from dust particles or lint, a filter is situated at the rear of the appliance. When this filter becomes blocked, the filter indicator will flash to indicate that it should be cleaned. Clean the filter weekly during the heating season to avoid unnecessary strain on the appliance.

Do not remove filter when appliance is operating. When the filter requires cleaning, clean filter before using the appliance, or whilst the appliance is not operating.

If you do not clean the filter at regular intervals and the filter indicator is allowed to remain flashing, then the appliance will stop and [14] will flash on the Digital Display signifying that the inbuilt safety device has functioned. You must clean the filter before operating the heater again.

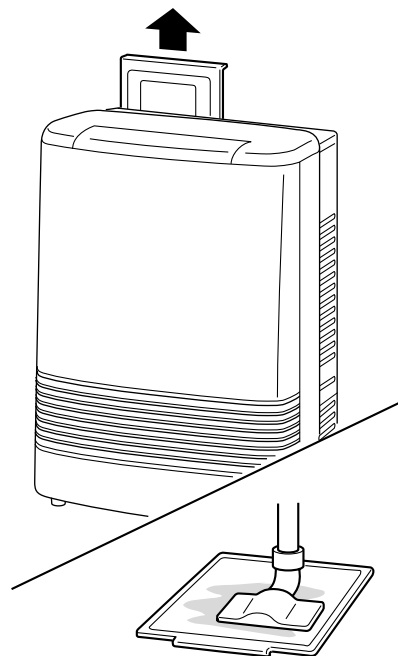

■ HUMIDIFIER TRAY

So that you can humidify the air, your Rinnai RHFE-308FTR is fitted with an enamelled tray at the bottom of the heater. If you choose to make use of the humidifier tray, it will need filling about once a day during the heating season. **Do not fill the humidifier tray while the heater is running.**

1 To fill the humidifier tray:

Remove the bottom trim panel, below the louvres, by pulling on both sides. Simply pull the tray forward to allow it to be filled with water. The warm air will be humidified as it passes over the water in the tray. Refit the bottom trim panel after filling the tray. The RHFE-308FTR is a very high efficiency appliance, during operation a small amount of condensation is produced in the flue system, this drains into the enamelled humidifier tray.

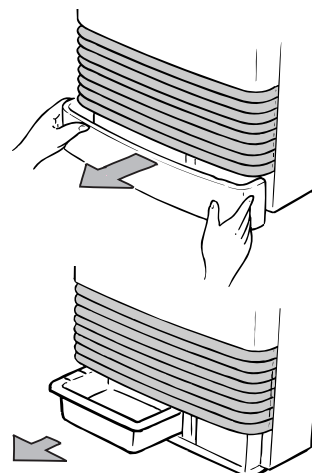

The humidifier has the benefit (when filled with water) of raising the humidity in the air. With increased humidity, the heater can actually be run at a lower temperature while still maintaining the same level of comfort.

■ VERTICAL LOUVRE ADJUSTMENT

The warm air flow direction may be altered by inserting a screwdriver or similar tool and gently bending the vertical louvre(s) either to the left or the right.

Note: These louvres are not designed to be adjusted more than 6 times.

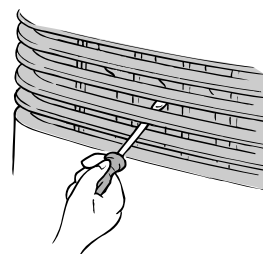

SETTING THE CLOCK

When the appliance is first plugged in and then turned on, the Digital Display will show --:--.
As an example, let's set the clock to 10:35 am.

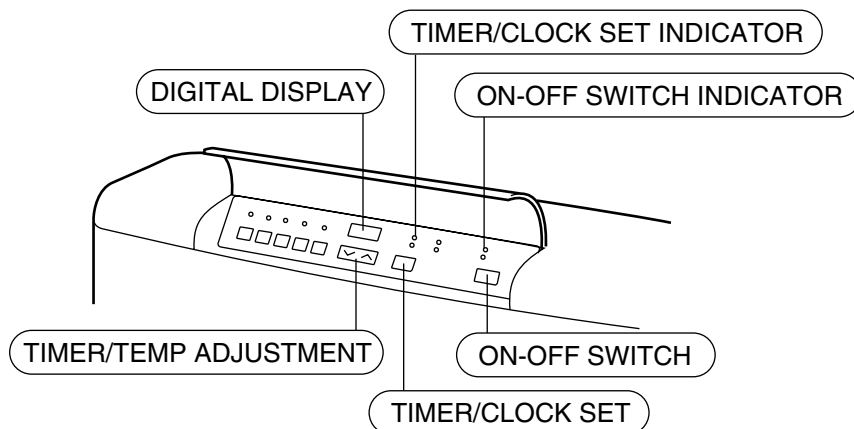

OPEN THE CONTROL PANEL - SEE PAGE 10.

1

When the appliance is first plugged in or after a power failure, the Digital Display will show --:--.

Press the Set Times button once, the Clock Indicator will flash.

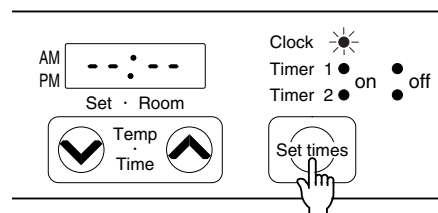

2

Press and hold the “^” button; the minutes will begin to change first, then the time will change by whole hours. Release the button when AM 10:00 shows on the Digital Display. Confirm that you have selected AM, a small indicator on the left hand side of the Digital Display indicates the AM setting.

Press and hold the “^” button again, release the button when AM 10:35 shows. If you go past AM 10:35, then the “v” button can be used to change the time settings in reverse.

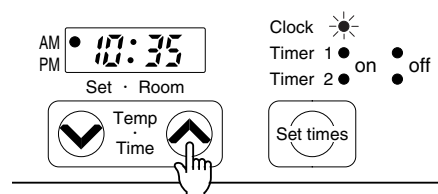
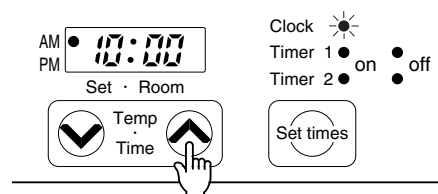

3

Press the Timer Set button five times to lock in and complete setting the time. The Clock and Timer indicators will go out. A small indicator on the Digital Display will flash to show that the clock is operating.

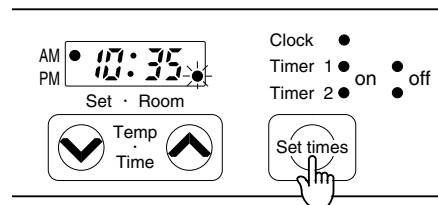

PROGRAMMING THE ON/OFF TIMER(S)

Before programming the Timers you must ensure that the clock has been set to the correct time. See page 14.

As an example let's programme Timer 1 to heat the room by 7:10 AM and finish at 9:00 AM.

1

Press the Set Times button twice. The Digital Display will show AM 6:00. Timer 1 indicator will flash.

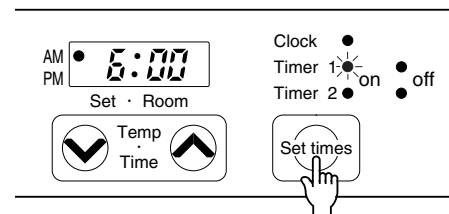

2

Press the “^” button until AM 7:00 appears, release the button, then press it again until AM 7:10 appears. (Press the “v” button if you go past AM 7:10.)

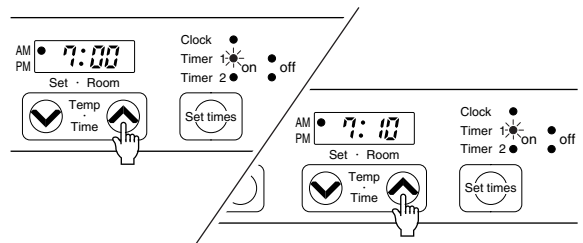

3

Press the Set Times button again, the Timer 1 OFF indicator will flash. Press the “^” button until AM 9:00 appears.

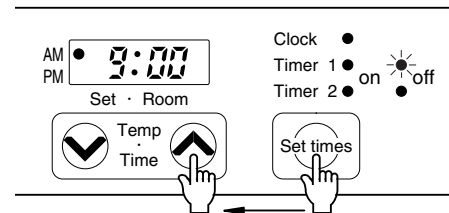

4

Press the Set Times button three times to lock in the programmed time. The Digital Display will show the current time. A small indicator on the Digital Display will flash to show that the Display has returned to the clock.

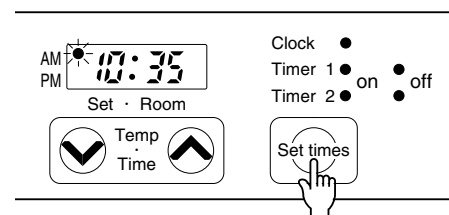

TURN TO NEXT PAGE TO OPERATE THE TIMERS.

TIMER 2 is programmed in the same way, remember to ensure that the Timer 2 indicator is flashing when you programme in the desired setting.

The Timers can be programmed to operate for any two periods in any 24 hours. Turn to next page to operate the dual timer.

The programmed time must be selected and locked-in within one minute of the On Timer indicators flashing otherwise the programmed times will not be retained in the system memory.

OPERATING THE TIMER(S)

Before operating the Timer(s), the clock time must be correct, and a starting time and finishing time for the Timer(s) must be programmed. See pages 14 and 15. The two Timers operate in the same way. This heater does not commence operation at the programmed starting time. It will attempt to heat a room by the programmed starting time. See Pre-heat page 17, for further explanation.

1

To select the Timer(s) to commence heating:

Check the time shown on the Digital Display is correct. See page 14. Check the ON and OFF times, for both Timers if necessary, see page 15.

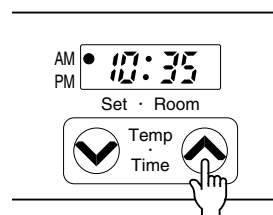

2

Press the ON-OFF button to operate the heater. The On indicator will glow green and the heater will begin to operate. Select the desired temperature setting.

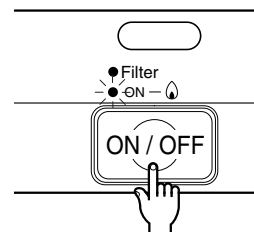

3

Press the Timer 1 and/or Timer 2 button(s). The Timer indicator(s) will glow and the heater will remain on standby until one hour prior to the time programmed into the selected Timer(s) is reached. When this time is reached, the Timer indicator will flash and the heater will operate. The ON indicator glows red when the heater commences operation.

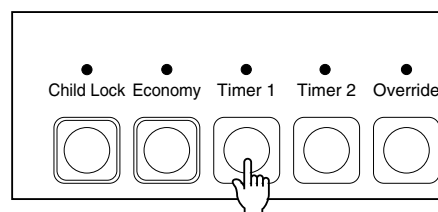

SET AND FORGET OPERATION

Your heater can be operated to alternate between Timers automatically during cold weather by selecting Timer 1 and Timer 2 together. Both Timer indicators will glow. The appliance will remain on standby at intervals between the programmed finishing and starting times of each Timer. While the heater is operating during programmed intervals the Timer indicator will flash.

If there is a power failure, the system memory will retain the Timer programs, and the clock will stop at the time the power goes off. The clock will start again when the power comes back on, but the time will be slow by the duration of the power failure. To set the clock to the correct time after the power has come back on, simply follow the instructions on page 14.

PRE-HEAT

1

This function operates automatically in conjunction with either of the Timers. When a Timer is selected, the heater may operate anywhere within an hour prior to the programmed starting time of the Timer.

The Pre-heat function will heat a room to the pre-set temperature by the programmed On Time.

This function is called Pre-heat due to the way it operates. The room temperature is sensed one hour before reaching the programmed time of either Timer.

The temperature differential at the time of sensing the room temperature, combined with the data from the previous operation governs exactly how long before the programmed On time the micro-computer will operate the heater and ignite the burner.

The following chart may help to improve understanding of the Pre-heat function.

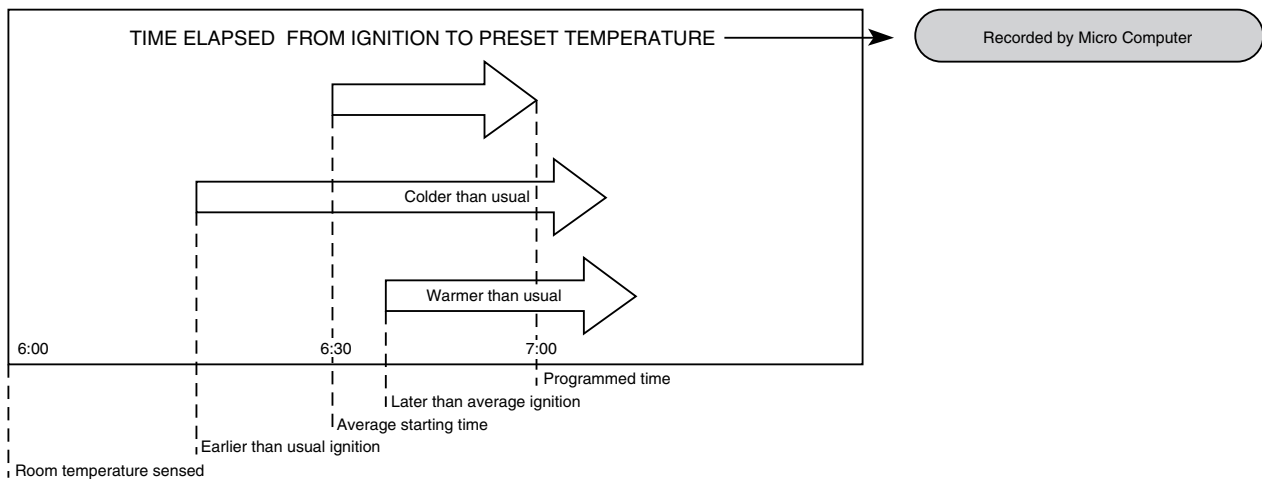

OVERRIDE FUNCTION

This function is intended to be used to manually override the current operation of the heater, For example; if the heater is in standby mode (i.e. between finishing time and starting time of a Timer), and the Override button is selected, then the heater will begin to operate, and heat the room.

1

To operate the Override simply press the Override button. The Override indicator will flash.

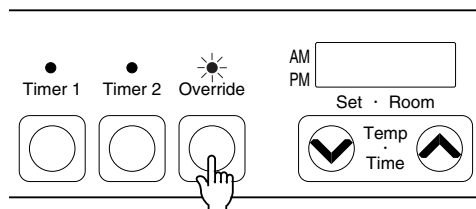

2

To manually deactivate the Override simply press the Override button again. The Override indicator will go out, and the heater will return to standby mode.

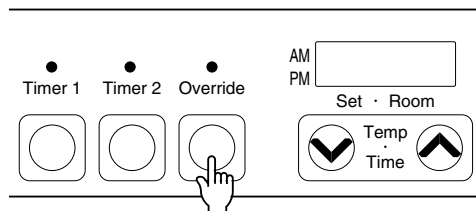

The heater will continue to operate on Override until the Override button is pressed again, or one of the Timers takes over the operation of the appliance. This means that the Override mode will automatically drop out if a programmed Starting time is reached. The appliance will then return to operating at times programmed into the Timer(s).

USING THE REMOTE CONTROL

To Turn ON or OFF

Remote Control will not turn heater ON if Timer(s) have been selected.

To manually operate when Timer(s) are not selected, simply press the ON or OFF button.

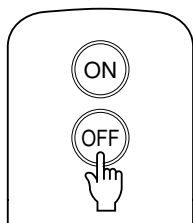

To Change Temperature

To alter the temperature at any time while the heater is operating, simply press the "▲" or "▼" buttons.

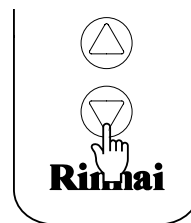

If the Timer(s) have been selected, and the heater is in standby mode, and the OFF button on the Remote Control is pressed, the Timer(s) will be deactivated.

CARING FOR YOUR NEW RHFE-308FTR

This appliance is controlled by a micro computer. If there is something wrong with the appliance then it will stop, as it is protected by the following safety devices.

Ignition Safety Device
 Burner Safety Device
 Overheat Safety Device

Power Failure Safety Device
 Power Surge Safety Device
 Fan Delay Safety Device

Your RHFE-308FTR requires very little maintenance, simply clean the rear fan filter once a week and wipe the outer case and louvre section with a damp cloth.

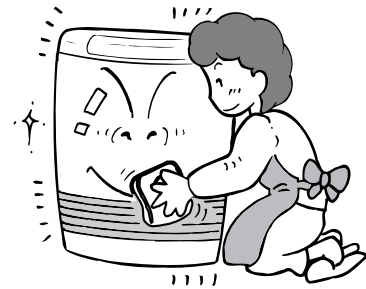

DO NOT USE SOLVENTS.

Solvents may melt or distort plastic parts.

Problem Cause									Remedy
	No ON indicator	Burner doesn't ignite	Unusual combustion	Combustion stops during operation	Smell of gas	Noisy ignition	Takes too long to warm the room	Remote control doesn't work	
Not Plugged In	●	●							Plug In
Power Cut	●	●		●					Re-ignite manually after power is restored
(Initial Installation) Air in gas pipe		●							Purge air (Installer)
Gas Filter Blocked		●	●				●		Service Call
Missed Ignition	●	●							Service Call
Flue terminal obstructed			●	●		●			Clear obstruction
Flue manifold not connected						●			Service Call
Louvre obstructed				●			●		Clear obstruction
Air filter blocked				●			●		Clean filter (weekly)
Gas Escape					●				Service Call
On Timer is set		●							Cancel On Timer
Child Lock set		●							Cancel Child lock
Gas turned off at meter	●	●							Turn gas on
Battery flat (remote control)								●	Replace battery

PRE-SERVICE CHECK

Before asking for a service call please check the following points.

These points are part of the normal operation of the unit.

■ At Ignition:

Heater does not operate.



Is the heater plugged in?
Have the fuses or breaker blown at the switch board?
Is there a power failure?
Is the air filter blocked?
Is anything blocking the outlet for the hot air?
Is the flue blocked?
Are Timers set? Clear Timers and operate again.

Warm air does not flow when the burner lights.



The fan is started automatically after a short delay. This is to allow the heat exchanger to warm up, helping to avoid cold draughts.

Smoke or strange smells are produced on the first trial light up after installation.



This is caused by grease or oil and dust on the heat exchanger and will stop after a short time.

Sharp clicking noises at ignition, or when the unit cuts down on the thermostat, or goes out.



This is simply expansion noise from the heat exchanger.

■ During combustion:

Clucking noise when the thermostat operates.



This is the sound of the solenoid gas valves opening and closing.

Unit is not heating room.



Is the air filter blocked?
Is the set temperature high enough?
Is the warm air outlet blocked by anything?
Are the doors and windows of the room closed?

Air filter is blocked or the louvres are blocked or obstructed.



Allow heater to cool, clean air filter, operate again.

Heater will not re-ignite after overheating.



Even after unit has cooled down the heater does not ignite again. Repair is necessary. Contact your local agent or Rinnai for a Service call.

■ When the unit is turned off:

Convection fan continues to run after turning OFF.



This is to remove the residual heat from the heat exchanger, the fan will stop when the heater cools down.

■ Other Points:

Steam is discharged from the flue terminal.



High efficiency appliances tend to discharge water vapour on cold days, this is normal.

Unit cuts off without apparent reason.



Check whether filters are blocked, dirty filters will cause the heater to overheat.

Power Failure.



Switch OFF, then ON again when power is restored to re-set controls.

ERROR MESSAGES

The Rinnai RHFE-308FTR has the ability to check its own operation continuously. If a fault occurs, an error message will flash on the Digital Display of the control panel. This assists with diagnosing the fault, and may enable you to overcome a problem without a service call. Please quote the code when enquiring about service.

Code Displayed	Fault	Remedy
11	Ignition Failure	Check gas in ON. Service call if repeated
12	Flame Failure	Check gas in ON. Service call if repeated
14	Overheat	Clean Filter. Service call if repeated
16	Room Overheat	Lower room temperature to less than 40 deg. C
31	Room Temperature Sensor Faulty	Service Call
32		
33	Overheat Temperature Sensor Faulty	Service Call
34		
49	Sensor Breakdown	Service Call
53	Sparker Failure	Service Call
61	Combustion Fan Failure	Service Call
70	Faulty On/Off Switch	Service Call
71	Faulty Solenoids	Service Call
72	Faulty Flame Rod	Service Call
73	Communication Error	Turn Heater Off, then back On
99	Flue Block	Check around flue terminal

In all cases you may be able to clear the Error message simply by turning the heater Off, then back On. If the Error message still remains or returns on the next operation contact Rinnai or your nearest service agent and arrange for a service call.

INSTALLATION INSTRUCTIONS

Important Safety Instructions

1. Gas Safety (Installation & Use) Regulations 1998 are the 'Rules in Force'.
In your own interest and that of safety, it is law that all gas appliances shall be installed by competent persons in accordance with the above regulations.
Failure to install appliances correctly could lead to prosecution. Other persons should NOT attempt to install this equipment.
2. Unpack the appliance and check it carefully. If it appears to have any operating defects DO NOT INSTALL, but contact the supplier.
3. This appliance is intended to be used to raise the temperature in a room or office etc. You should NOT use it for any other purpose without seeking advice from the supplier.
4. This appliance is safe if correctly installed and sited. Please comply CAREFULLY with the instructions.
5. This appliance is to be used for NATURAL GAS (G20) and PROPANE (G31) only. It must NOT be used with any other type of gas.
6. Installation MUST be carried out in accordance with the current issue of:
 - a) Building Regulations issued by the Dept. of the Environment and Building Standards (Scotland Consolidation) Regulations.
 - b) I.E.E. Wiring Regulations for electrical installations.
 - c) Gas Safety (Installation and Use) Regulations 1998.
 - d) BS5871 Part 1:2001
 - e) BS5440 Part 1:2000 and Part 2:2000
 - f) BS6891 Part 1:1998 (Natural Gas) and BS5482 Part 1:1994 (Propane).
 - g) Local Byelaws
 - h) Children & Young Persons Act 1933 revised 1952
 - i) Health and Safety at Work etc. Act, 1974
 - j) Such other specifications or legislation that may have superseded the above documents.
7. Should the heater be fitted in a room where there are young children; elderly; infirm or handicapped persons, it is strongly recommended that a guard is fixed around the heater.

Guards conforming to British Standard Specification 6778:1986 (Fireguards for Use with Portable Free Standing or Wall Mounted Heating Appliances) in respect of fixing, strength and painted finish are acceptable and overall dimensions should be such that there is a gap of at least 100mm (4 inches) between the guard and the heater. Standard guards that meet these requirements are available from the supplier.









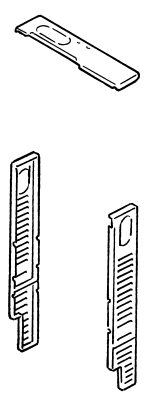

Please be sure you are aware of the implications of these notes.

INSTALLATION INSTRUCTIONS

Specification

Input: 3.4kW
 Ignition: Continuous Spark
 Flue: Forced Flue (Components supplied separately.)
 Gas Control: Rinnai Electronic Modulating Control
 Electrical Supply: 230V, 50Hz. This unit has a supply lead and 3 pin plug.
 Burner: Stainless Steel Bunsen Type
 Gas Inlet: 1/2 in. BSP

Remove parts from carton and check that all parts shown below are included in the installation kit.

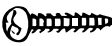
Back Spacer Set		1	Flue Locking Clamp		1
			Insulation Clip		1
			Plastic Tie for air inlet		2
			Hose Clip		1
Wall Bracket		1	M4 for Securing Flue		3
Spacer Bracket		1	M4 for Air Intake Clip		2
M4 for Back Spacer Set		10	M4.8×32 wood screws for wall bracket and flue manifold.		5
Customers Installation and Operating Instructions		1			

Check the unit supplied is correct for the gas type in your area.
 Refer to local gas authority for confirmation of gas type if in doubt.
 Refer to data plate located inside the front panel.
 Check for damage, if the unit is damaged contact your supplier of Rinnai UK.
 Do not install a damaged unit before checking with your supplier.
 Refer to an approved pipe sizing chart if in doubt about size of gas pipe.

LOCATION

When positioning the heater the main points governing the location are:

1. Flueing
2. Warm air distribution

This heater must not be installed where curtains or other combustible materials could come into contact with it.

In some cases curtains may need restraining.

See diagram for other recommended clearances.

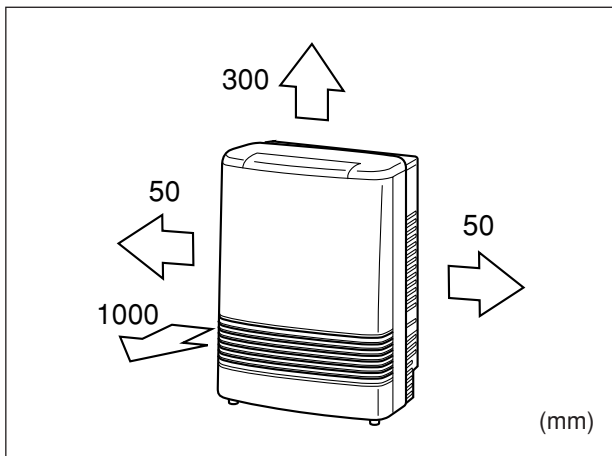

Flue fittings must be kept clear of flammable materials.

This heater is not designed to be built in.

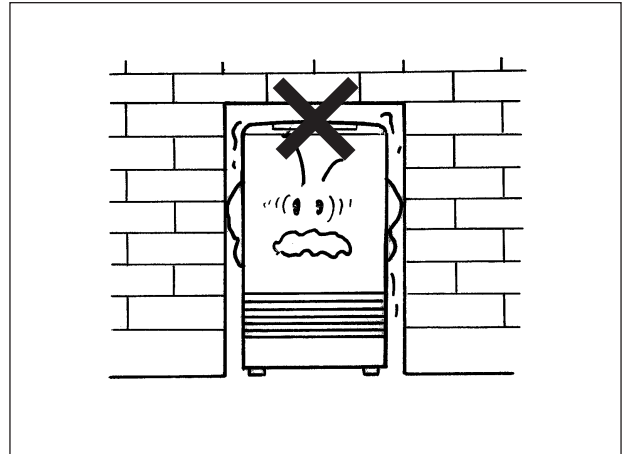

The flue is not designed to be positioned under floors, or below the level of the heater.

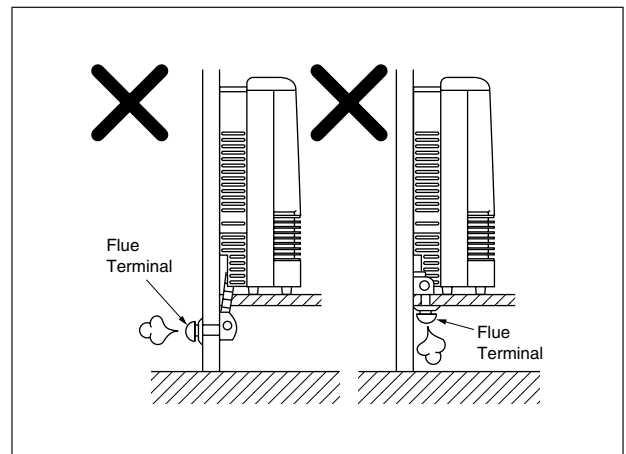

The flue terminal should be positioned away from flammable materials.

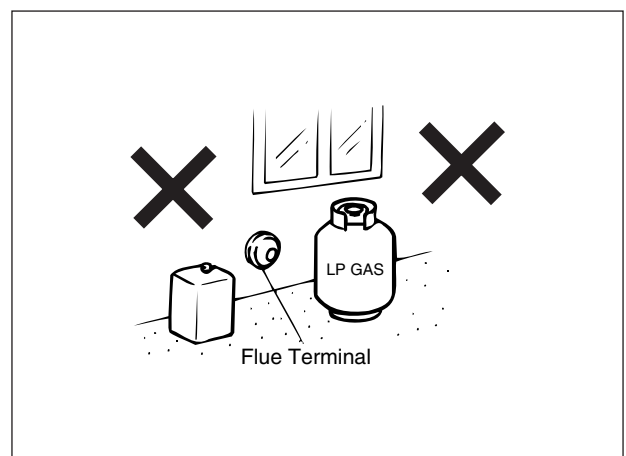

LOCATION

Do not flue into natural draught flues or fireplaces, this unit can only be used with one of the six types of Rinnai flue kits.

Do not flue unit into other rooms.

Flue terminal must be outside.

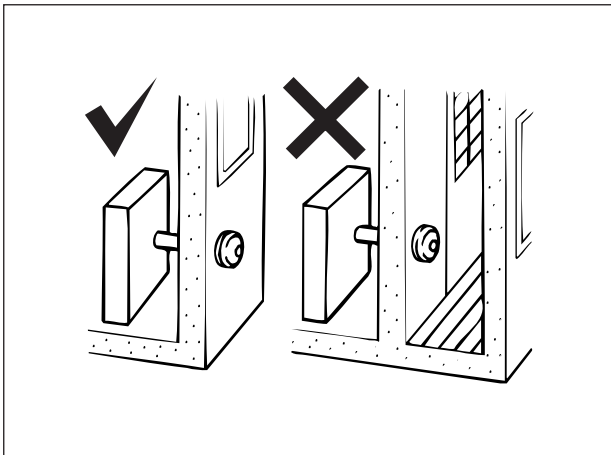

Flue may be positioned directly under opening windows, with a minimum clearance of 300mm.

FLUE SIZES:

6 Flue lengths are available.

S	flue suits wall	75	-	115 mm
A	flue suits wall	115	-	240 mm
B	flue suits wall	240	-	400 mm
C	flue suits wall	400	-	600 mm
D	flue suits wall	600	-	800 mm
E	flue suits wall	800	-	1000 mm

Co-ax flue also available.

SNOW AREAS

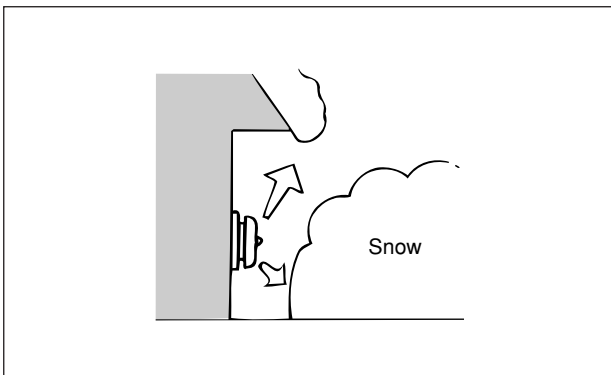

In areas subject to heavy snowfall, keep snow clear of flue terminal at all times.

STANDARD INSTALLATION OF FLUE MANIFOLD.

Diagram below shows minimum clearances and distances from obstructions. Also check local regulations.

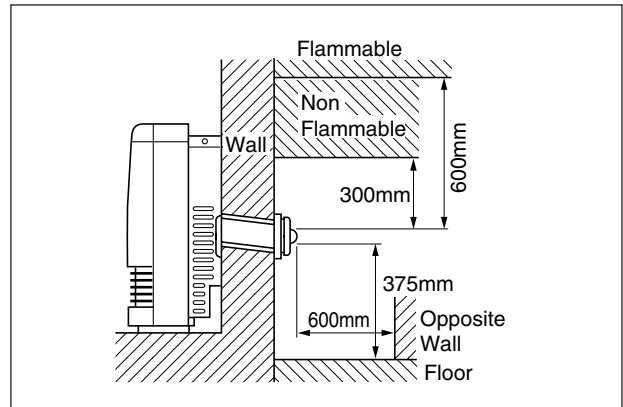

Side Clearances

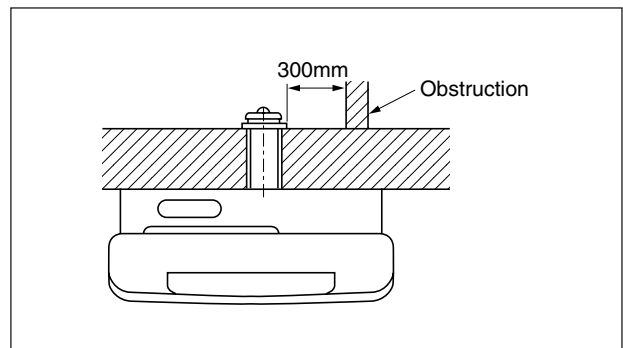

FIT BACK COVERS (SIDES ONLY)

Fit back covers (sides only) as shown below.

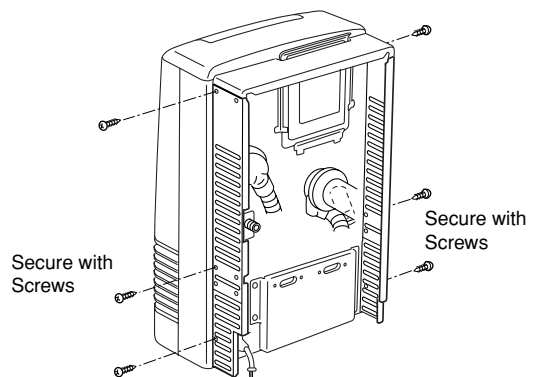

GAS CONNECTION

Fit suitable copper flare elbow to appliance inlet.

LOCATION

Do not install the heater in an unusually dusty area.

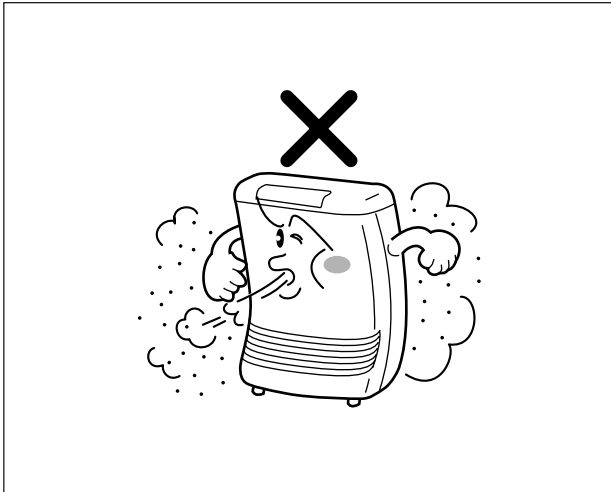

- Use a flue guard if the terminal is easily accessible to children.
- Check local regulations.
- Guards are available as an optional extra.

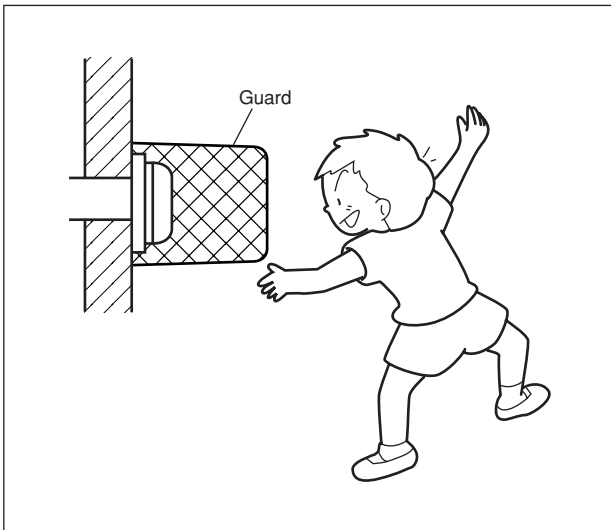

- Floor must be level.
- Do not use electrical extension cords to connect the unit to a power supply.
- Keep the power cord away from the flue.

FLUE MANIFOLD POSITION

Important

The centre of the hole for the flue manifold must only be drilled in the position indicated on the diagram below.

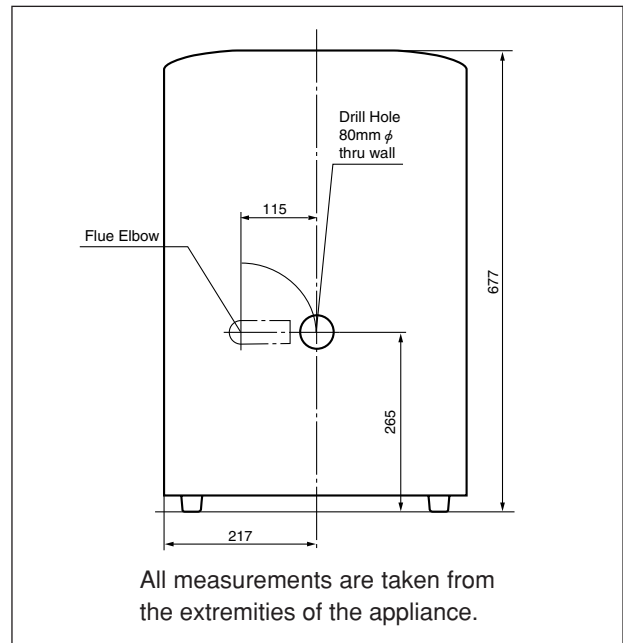

Before drilling the flue hole, check for water and gas pipes as well as electric cables.

For weatherboard walls drill through centre of the weatherboard from the outside, then drill from inside through the plaster board.

WALL MOUNTING BRACKETS

- Place top back spacer.
- Mark the position of the top edge of the top spacer on the wall.
- Move the heater away from the wall.
- Mark the centre lines 30mm down from the top edge mark, and 40mm in from the left and right hand sides of the top spacer.
- Attach wall brackets at the marked position. Remove right hand back spacer.

INSTALLING THE FLUE

General.

The flue must be installed in accordance with:

Manufacturers Installation Instructions
British Standards including BS 5440 and BS EN 1319:1999
Gas Safety (Installation and Use) Regulations
IGE/UP/10 Part 1 Edition 2.
Building Regulation J

The flue must be installed by a competent, authorised person. It is the installer's responsibility to ensure that the unit has been installed to all current requirements.

The Rinnai RHFE-308 FTR may only be installed with the approved Rinnai Infinity flue kit provided. Before commencing installation, please read the Installation Instructions within this book.

The required clearance of the flue terminal is shown on page 28. A terminal guard cage must be installed over all terminals under 2m high.

The flue can be run horizontally or vertically. The maximum run should not be more than 7.0m, and for each 90° bend the maximum run is reduced by 1.0m, to a max. 3 bends.

The nature of the appliance will not cause condensation in the concentric flue pipe under normal operation if the flue is less than 2.5m. If the flue is over 2.5m the horizontal sections should slope back to the unit except for the horizontal section through the wall that should slope to the outside to prevent ingress of rainwater. The flue should be bracketed to prevent sagging.

POSITIONING THE FLUE TERMINAL

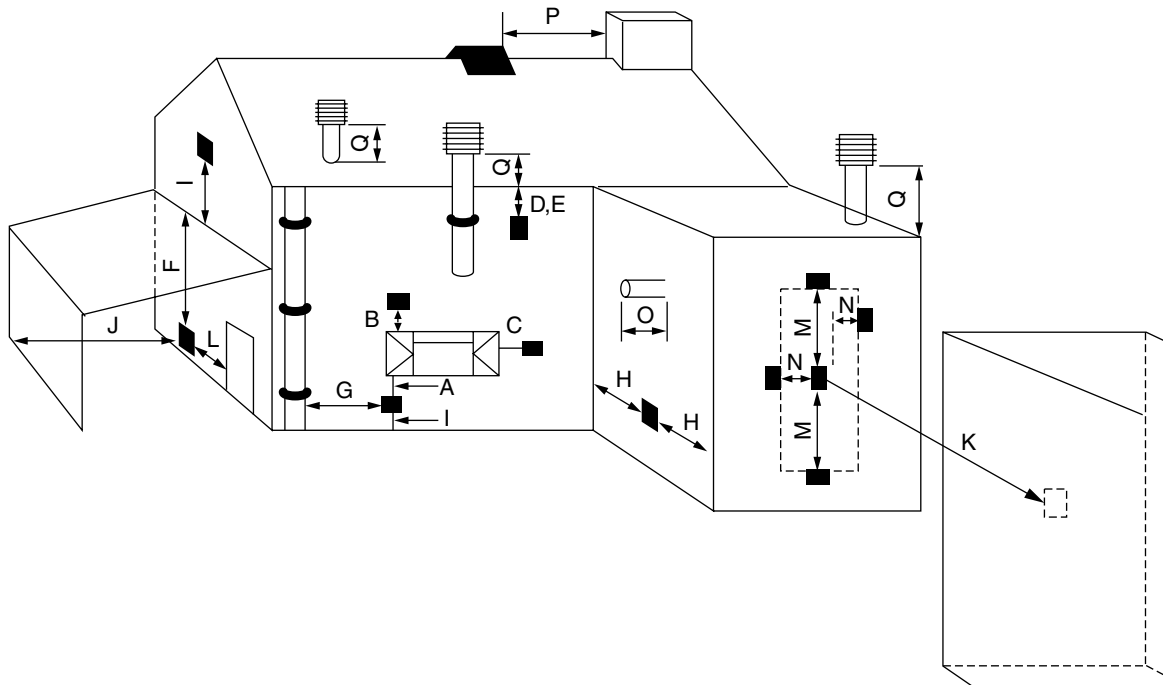

Dimension	Terminal Position	Distance
A	Directly below an opening, air brick, opening windows, etc.	300mm
B	Above an opening, air brick, opening window, etc.	300mm
C	Horizontally to an opening, air brick, opening window, etc.	300mm
D	Below gutters, soil pipes or drain pipes.	75mm
E	Below eaves.	200mm
F	Below balconies or car port roof.	200mm
G	From a vertical drain pipe or soil pipe.	150mm
H	From an internal or external corner.	200mm
I	Above ground, roof or balcony level.	300mm
J	From a surface facing the terminal.	600mm
K	From a terminal facing a terminal.	1200mm
L	From an opening in a car port. (e.g. door, window) into a dwelling.	1200mm
M	Vertically from a terminal on the same wall.	1500mm
N	Horizontally from a terminal on the same wall.	300mm
O	From the wall on which the terminal is mounted	N/A
P	From a vertical structure on the roof.	N/A
Q	Above an intersection with roof.	N/A

SLEEVE AND MANIFOLD INSTALLATION

METHOD FOR STANDARD WALLS

1. Dis-assemble Manifold from Sleeve.

The flue consists of 3 parts, sleeve, inside connectors and tube, outside terminal and inner connections, then pull sleeve off outer terminal).

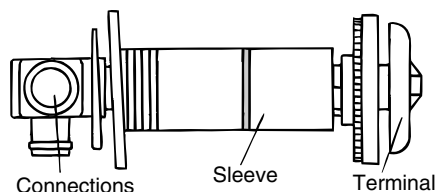

2. Adjustment of Sleeve Length.

Measure wall thickness through previously drilled 80mm hole. End of sleeve should protrude 5-10mm from outside wall. Adjust sleeve length to wall thickness plus 5-10mm. (Sleeve is threaded for adjustment).

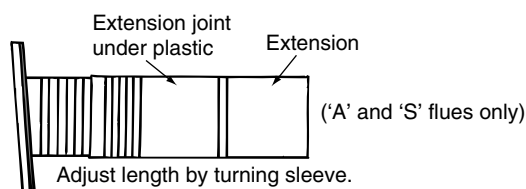

3. For A and S flues only

Depending on flue set and wall thickness extension piece "C" may need to be removed. Cut plastic, remove extension, then follow instruction 2. This applies to "A" and "S" flues only. There is no extension on other flues, they can be fully adjusted by turning the threaded section.

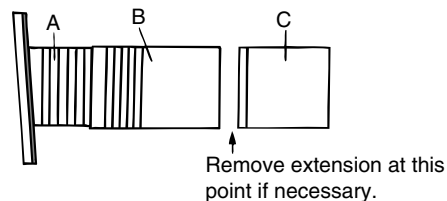

4. Fixing Sleeve.

Fix to the wall, using the 3 screws provided.

NOTE:

The flange is marked "TOP", sleeve must be fitted with this mark UP. Check sleeve protrudes 5-10mm on the outside.

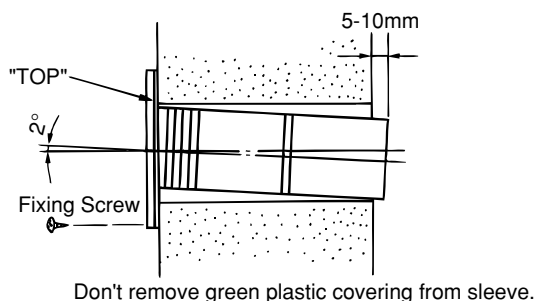

SLEEVE AND MANIFOLD INSTALLATION

METHOD FOR STANDARD WALLS

5. Check rubber seal is in place on terminal.

* For weather board walls, add spare rubber seal provided to compensate for weatherboard angle.

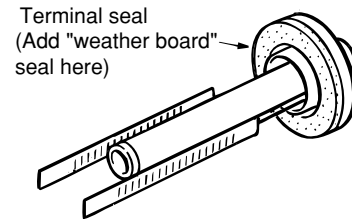

6. Installation of Terminal

From outside, insert terminal into sleeve with the "A" mark at the top. Left hand side fixing tie is marked "LEFT" (from inside).

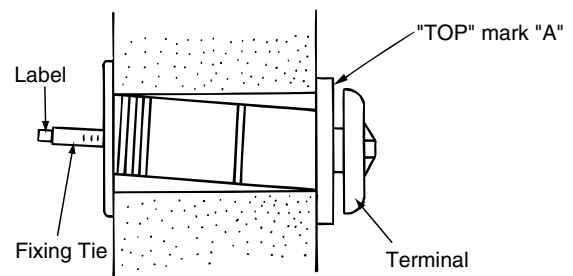

7. Attaching Ties

Pull hard on left and right hand side ties, clip ties over lugs inside sleeve. You should be able to pull ties 2 or 3 slots past the starting point. Cut the ties, leaving about 20mm past the lugs. Bend ties so they are parallel with the wall.

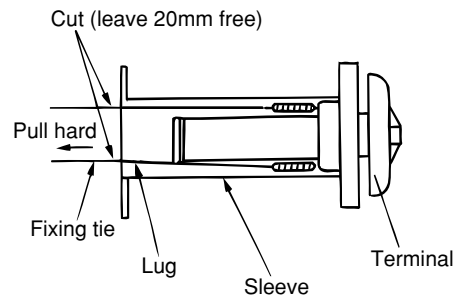

8. Insert Inner Connection Assembly. Push assembly into the terminal tube, make sure "TOP" mark is uppermost. Fix with 3 screws provided.

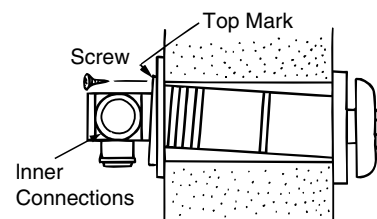

9. Manifold can still be turned after attaching.

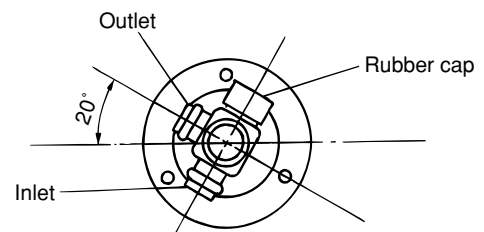

FITTING UNIT

AIR INLET HOSE

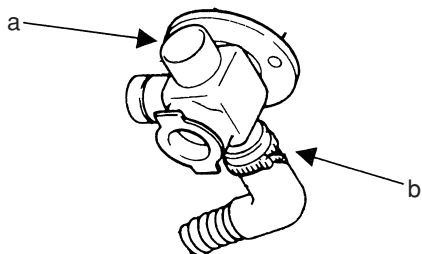

Attach the Air Inlet Hose to the flue manifold on either inlet position a or b. The unused inlet is plugged with the rubber cap supplied on the manifold.

EXHAUST PIPE & LOCKING CLAMP

The following components can be fitted by reaching down the rear of the appliance as it is positioned against the wall.

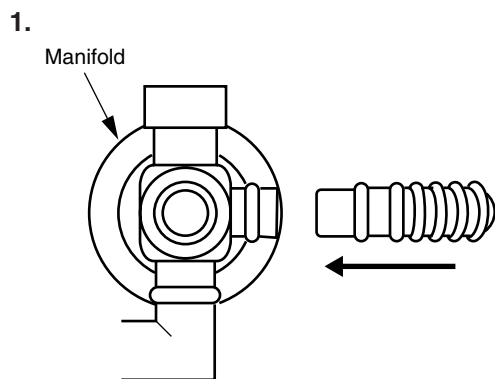

1. Connect the flue elbow to the manifold by moving the appliance into position.

2.

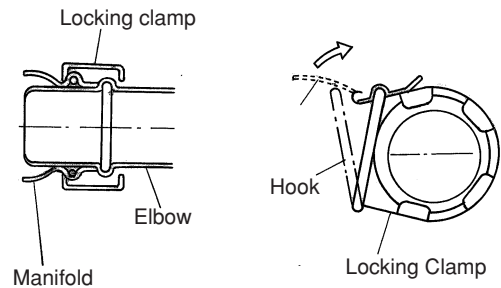

Fit the locking clamp over the connection between the flue elbow and the manifold. Engage the hook and rotate it until it snaps against the body of the clamp.

3.

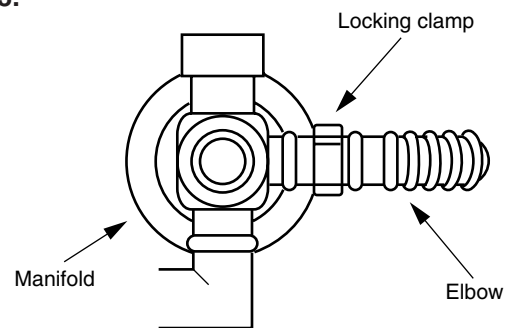

4.

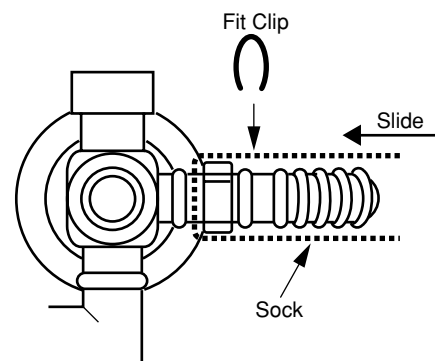

Slide the insulation sock up to the flue manifold and slip the securing clip over the sock as shown.

FORCED FLUE HEATER EXTENSION KITS

EXTENSION KIT PARTS AND INSTALLATION GUIDE

FOT - 155	0.5m EXTENSION KIT
FOT - 156	1.0m EXTENSION KIT
FOT - 157	2.0m EXTENSION KIT
FOT - 158	BENT ELBOW KIT
FOT - 160	LONG FLEX TUBE 600 KIT

Rinnai

- This extension set is to be used for installations requiring extra distance.
MAXIMUM FLUE LENGTH 4.5m WITH 3 ELBOWS

■ NAMES AND NUMBERS OF PARTS

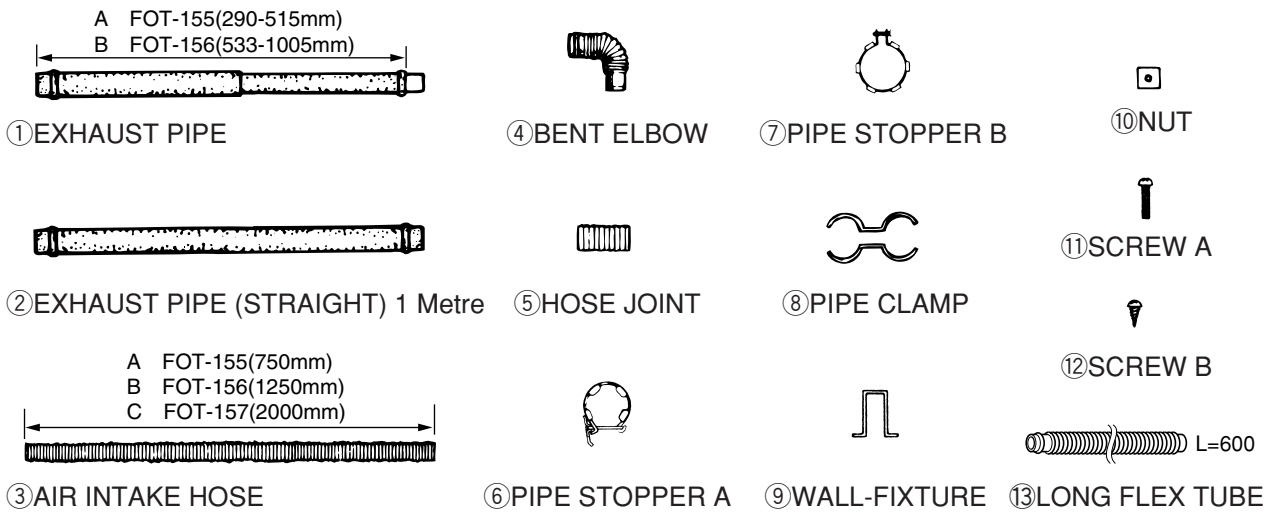

		PARTS No.	FOT-155	FOT-156	FOT-157	FOT-158	FOT-160
①	A	EXHAUST PIPE	FOT 081-2	1			
	B	EXHAUST PIPE	FOT 082-2		1	1	
②		EXHAUST PIPE (STRAIGHT)	FOT 157-3			1	
③	A	AIR INTAKE HOSE	RHF 300-51-6	1			
	B	AIR INTAKE HOSE	RHF 300-51-7		1		
	C	AIR INTAKE HOSE	RHF 300-51-3			1	
④		BENT ELBOW	FOT 087-002			1	
⑤		HOSE JOINT	FOT 062-12	1	1	1	
⑥		PIPE STOPPER A	305F-0017	1	1	2	1
⑦		PIPE STOPPER B	FOT 081-4	1	1	1	
⑧		PIPE CLAMP	FOT 062-8	2 SET	3 SET	4 SET	
⑨		WALL FIXTURE	FOT 062-9	2	3	4	
⑩		NUT	FOT 062-10	2	3	4	
⑪		SCREW A	ZAA0422SC	2	3	4	
⑫		SCREW B	ZEAA0412SZ	4	6	8	
⑬		LONG FLEX TUBE	FOT 160-2				1

FLUE EXTENSION KITS

INSTALLING AN EXTENSION KIT FOR THE RHFE-308 FTR

Installing an extension kit requires construction of an air line and the flue line. The air line is connected between the Air Supply Elbow at the rear of the heater and the air inlet port on the Flue Pipe. Similarly, the flue line is connected between the joint pipe at the rear of the heater and the flue port on the flue pipe.

Caution: Check to see there is no debris in the pipe or hose.

HOW TO INSTALL

Example. Extension to left of unit facing forward using elbow. (View from rear.)

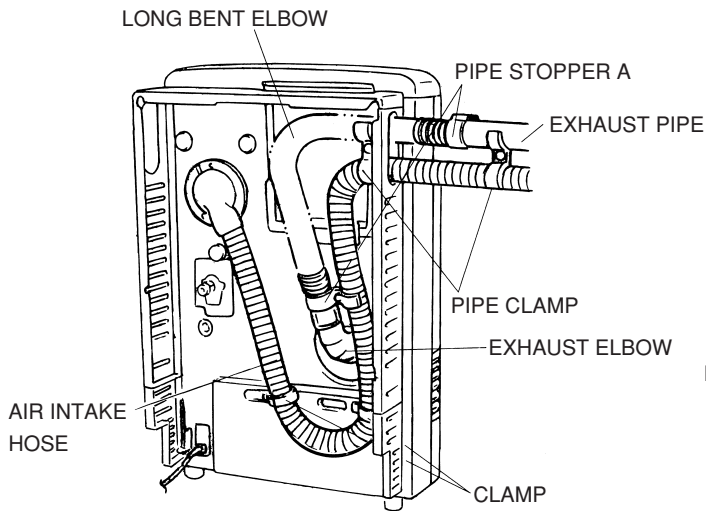

Example. Extension to right of unit facing front using elbow. (View from rear.)

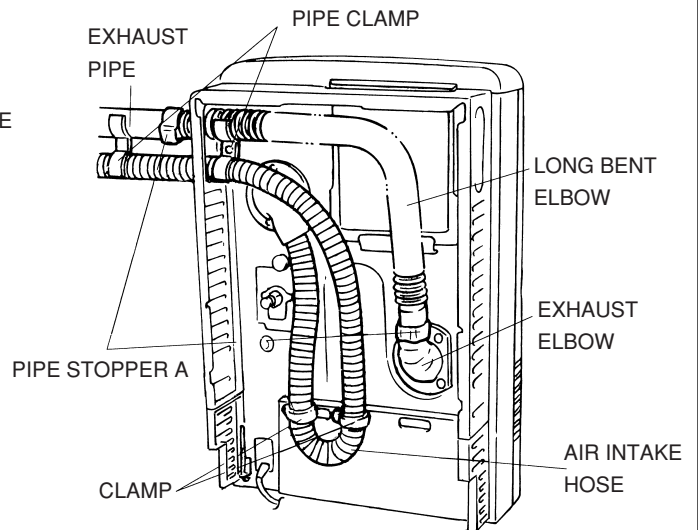

Example. Extension above the unit (View from rear.)

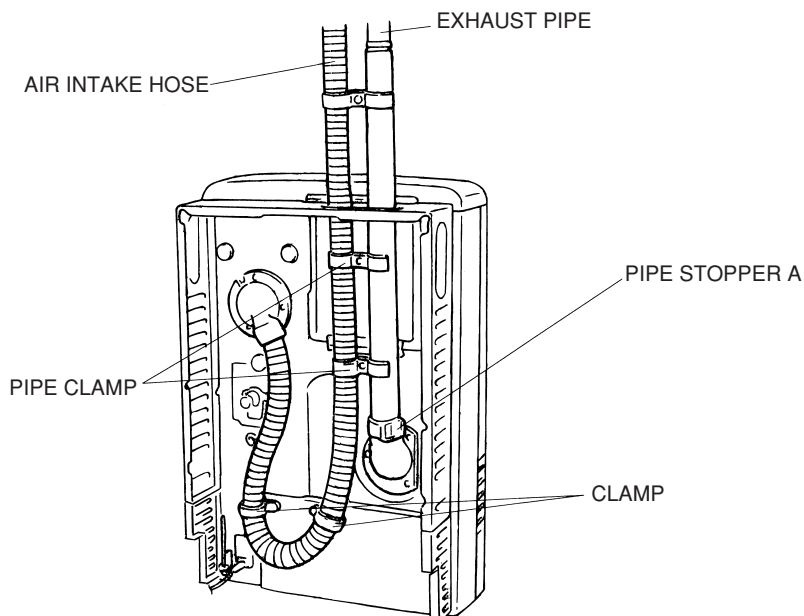

FLUE EXTENSION KITS

1. How to connect the flue pipes.

To connect the rigid flue pipes fit the male end into the female end and clamp with pipe stopper A to prevent slipping. The flue pipe can be telescoped to the required length: **DO NOT CUT IT.**

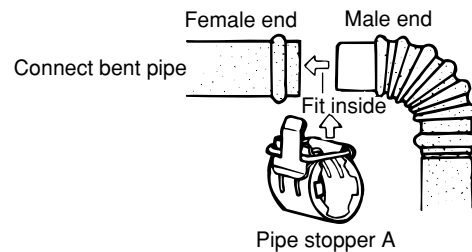
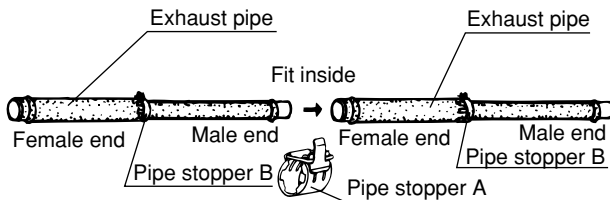

2. How to connect air intake hose.

Screw one air intake hose into socket of the appliance's main air intake hose. If this is not long enough then join air intake hoses together by screwing them both half way into a hose joint socket.

Important: The PVC air line is longer than the flue line and may need to be cut down to size. Be sure to thoroughly debur all rough edges.

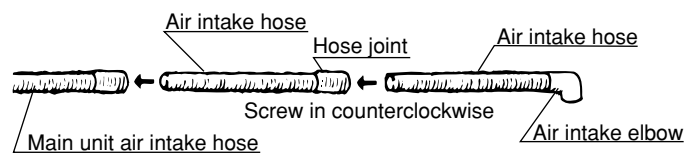

3. Affixing the air intake hose and flue pipe.

NOTE: Maintain 25mm clearance between flue pipe and combustible materials (0mm clearance between flue pipe and non-combustible materials.)

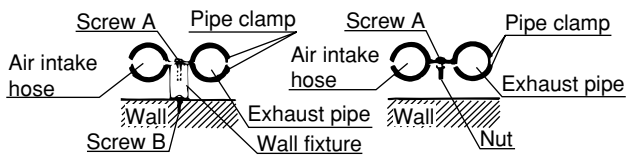

Set the air intake hose and flue pipe into the pipe clamps, screw the clamp onto the wall fixture, and affix to the wall with screw B.

The air intake hose and flue pipe can also be screwed onto the wall using the pipe clamp and the nut.

4. How to use the bent pipe.

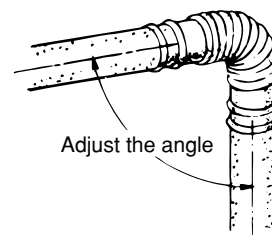

With the flue pipes inserted into the ends, bend the bent pipe to the angle required for installation.

This part is usually used for curves or connection to vent terminal.

FLUE EXTENSION KITS

■ CAUTIONS

1. **Maximum extendable length**
FOR BEST ROOM AIR HUMIDITY, KEEP WATER IN THE HUMIDIFIER TRAY.

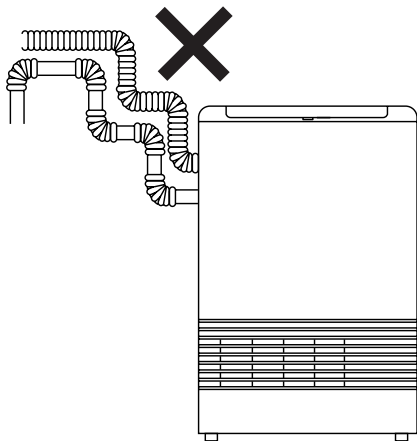

- 7.0 Metres less 1m per bend to a max 3 bends.
- The bend where the hose and pipes leave the body is not counted.
- The air intake hose should run along the exhaust pipe.

3. Condensed water formed by combustion, will run back to the unit, and may overflow from the condensation pan if pipes are longer than **2.0 metres**. Therefore, pipes exceeding these lengths should be made to drain to the outside by giving their horizontal portions 3° or more downward and outward slope.

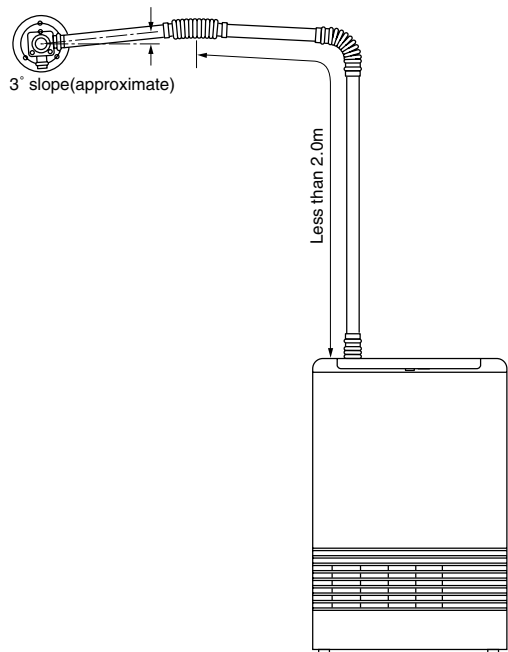

2. **To prevent water condensation**

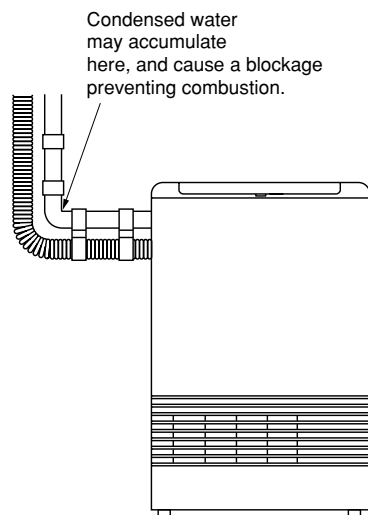

CAUTION

Never allow the exhaust pipe to sag, as condensed water may accumulate and cause incomplete combustion.

4. Wherever the air intake hose and exhaust pipe run sideways, try to have the exhaust pipe on top (to prevent the air intake hose from sagging onto the exhaust pipe.)

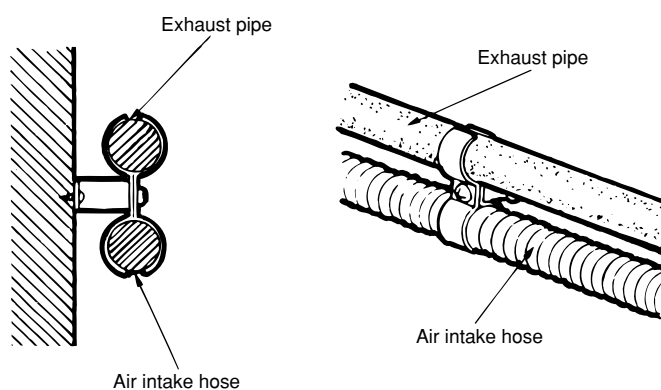

CONVERSION

The following procedure must be followed to convert the unit from Nat. Gas to LPG.

1. Hold both ends of the bottom cover. (Undercover ass'y) and pull toward you to remove the cover. Cover is snapped into place. (See fig #1)
2. Remove the 7 screws that secure the front panel and the louver assembly and remove panel from the unit. Pull the panel out at the bottom about 100mm and lift up over clips that hold it in place at the unit's top. (See fig #1 and #2)
3. Remove 1 screw from the overheat switch mounting plate. Place bracket and switch to the side out of your way. (See fig #3)
4. Remove the nozzle manifold 2 screws. Then replace all (2) orifices with the proper size for gas type to be used. (See fig #3 and #4)
5. Remove damper inside burner 1 screw. Then pull the damper and secondary air damper out and replace with proper secondary damper. (See fig #4)
6. Ensure proper relationship of electrode and flame rod to the burner. (See fig #5)
7. **VERY IMPORTANT:** Gas type and gas pressure must now be altered for the type of gas the unit has been converted to. The procedure for this is detailed on page 39; Gas Pressure Setting.

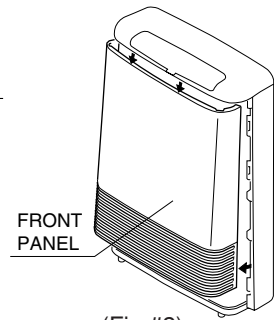
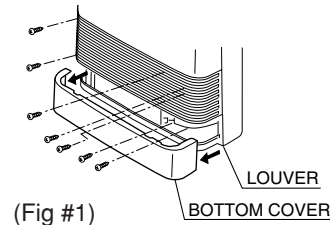

OVERHEAT SWITCH MOUNTING PLATE

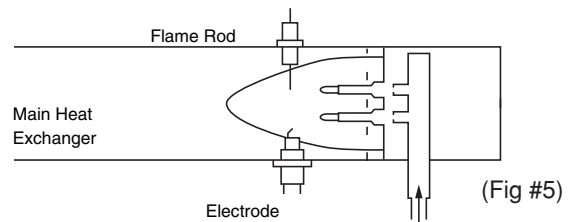
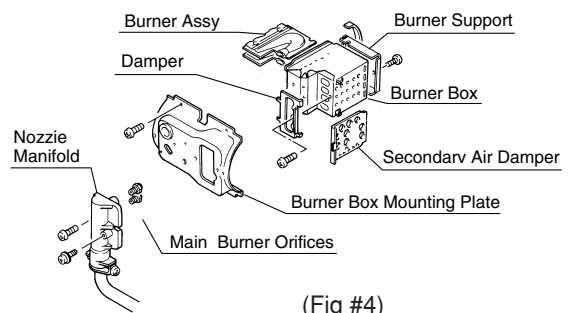
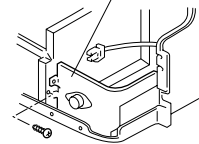

CONNECTING GAS AND ELECTRICAL SERVICES

1. GAS CONNECTION.

Purge any air or swarf from the gas line. Connect up the appliance to the gas supply using a union service cock to facilitate servicing.

Inlet connection size Gas (1/2 inch male BSP)

Check gas soundness using leak detection fluid, not naked flame. Connection can be easily reached from right hand side rear of appliance. Remove bottom trim (pulls off). Remove louvres (6 screws) and front panel.

2. ELECTRICAL CONNECTION.

WARNING: This appliance must be earthed.

This appliance is suitable for 230V-50Hz mains only and external wiring must be carried to out I.E.E. regulations.

Connect appliance to electrical supply using moulded plug supplied. A means of completely isolating the heater from the supply with contact separation of at least 3mm on all poles must be provided for servicing. The fuse should be 3amp.

Observe polarity and ensure that wiring is correctly restrained.

E Earth	 Green / Yellow
L Live	Brown / Red
N Neutral	Blue or Black

IMPORTANT

Do NOT use a clock or any type of switch on the electrical supply apart from the means of isolating the supply for servicing. (A clock or switch would also turn OFF the convection fan causing overheating).

3. This heater has a built-in timer but may also be connected so as to have over-riding control from a central clock.
 1. For time control using built-in clock only, set up clock as described on page 14 of these Instructions.
 2. For use in Offices or Schools etc. where all heaters are connected to a central control system which shuts down all services at the end of the working day but where individual heaters can still be set up to separate users needs, refer to **Rinnai UK** for appropriate Conversion Kit.

TESTING

Testing Unit

Purge air from gas line.
Refer to pipe sizing chart if in doubt about the size of the gas line.

Connection can easily be reached from the top, rear or the unit. Check for leaks using soapy water or leak detection spray after turning gas on.

Plug unit in and turn power on, (CAUTION: 230V AC inside unit.)

Turn thermostat to HIGH, turn control to ON.
Unit should ignite within 10 seconds.

If unit does not ignite there may still be air in the gas line. Turn control OFF, then ON.

Check pressure, Regulator is factory set.
If pressure is incorrect, CHECK SUPPLY PRESSURE BEFORE ALTERING REGULATOR.
The heater must be stopped before checking pressure.

Remove the 2 test point screws and connect the manometer hoses to the differential pressure test points on the modulating valve and burner manifold.

Turn the unit to the ON position using the On/Off button on the control panel and check pressure. If pressure is correct remove manometer and replace test point screw.

Leak test all gas connections.

Warning: DO NOT OPERATE APPLIANCE UNTIL PROPER INSTALLATION HAS BEEN COMPLETED.

The gas pressure check must be carried out with all other appliances on the same main operating at maximum capacity to ensure that there is sufficient gas pressure.

With all other appliances operating the pressure at the test point on the inlet to the gas valve should read **20 mbar** for Natural Gas. For LPG (Propane) the pressure should be **37 mbar**. If the pressure is lower, the gas supply is inadequate and the water heater will not operate to specification. Check gas meter, regulator and pipework for correct operation/sizing and rectify as required. Note that the gas regulator on the Infinity is electronically controlled and factory pre-set. Under normal circumstances it does not need adjustment during installation.

Fault - Finding Procedure

If unable to get the unit to operate correctly, contact Rinnai UK.

Do not use this heater if any part has been under water. Immediately call a qualified service technician to inspect the heater and to replace any part of the control system and any gas control that has gotten wet.

WARNING: Do not operate appliance with any panels removed, cracked or broken.

Installation and repair should be done by a qualified service person. The appliance should be inspected before use and at least annually by a qualified service person.

More frequent cleaning may be required due to excessive lint from carpeting, bedding material, etc.

It is imperative that control compartments, burners, and circulating air passageways of the appliance be kept clean. Ventilating system should be inspected and cleaned annually of all debris and spider webs.

GAS PRESSURE SETTING

The working gas pressure on the water heater is electronically controlled and factory set. Under normal circumstances it **does not** require adjustment during installation. Perform this procedure only if the unit is not operating correctly and **all** other possible causes for incorrect operation have been eliminated, **or you have converted the Gas Type.**

Contact Rinnai UK before attempting to alter the gas pressure.

Turn the appliance to the OFF position.

1. There are two test points, one on the heat exchanger, one on the gas manifold. Connect a differential pressure gauge between both test points. (Connect one side of the gauge to one point, the other side of the gauge to the other). If you are using an electronic manometer, connect the ⊖ side to the heat exchanger test point.

2. When the unit has completely stopped press and hold the SW1 test switch at the top of the PCB until it beeps.

3. Select the correct gas type code on the LED display using UP and DOWN arrow buttons. Current selected gas type will be indicated.

L1: LPG gas, short flue

L2: LPG gas, extended flue over 2.0m

A1: Nat. Gas, short flue

A2: Nat. Gas, extended flue over 2.0m

4. After selecting the appropriate gas setting above, press the SW1 test button to record the gas type code into the memory. The LED will then display the F1 for proper Flue Block Function. If it is not, set the display to the F1 by using the UP and DOWN arrows.

5. Press the SW1 test button to enter the proper Flue Block Function into memory.

6. Next the Temperature Classification code will appear on the LED display. Using the UP and DOWN arrows select Celsius.

7. Press the SW1 test button to enter your selection into the memory.

THE LED DISPLAY TURNS BLANK AND THE UNIT RETURNS TO THE NORMAL OFF MODE. YOU ARE NOW READY TO PROGRAM IN YOUR CORRECT LOW FIRE AND HIGH FIRE GAS PRESSURE SETTINGS. FOLLOW PROCEDURE BELOW FOR SETTING THE MANIFOLD DIFFERENTIAL GAS PRESSURE. **DO NOT** ADJUST GAS PRESSURE ON THIS APPLIANCE USING THE APPLIANCE REGULATOR SCREW.

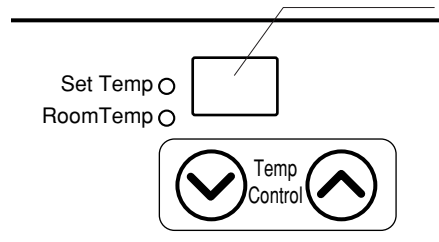
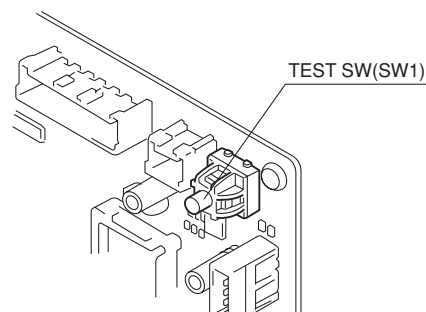
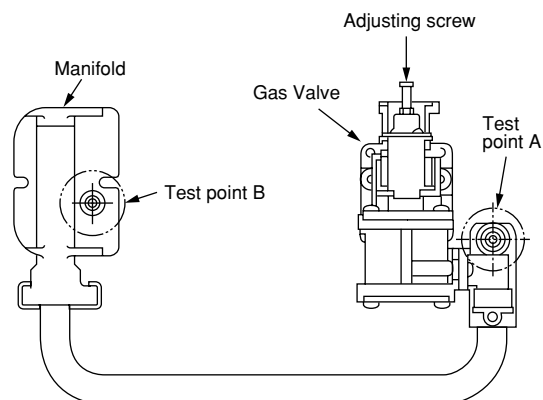

GAS PRESSURE SETTING

1. With your manometer gauge zeroed and connected to both pressure taps, press the On/Off button and operate appliance.
2. Press the SW1 test switch. 78 or 7≡ will be displayed on the indicator LED.
3. Press the SW1 switch again to put the appliance in Low pressure mode. PL will appear on the LED display.
4. Adjust the low pressure using the UP and DOWN arrows until the pressure differential shown on the manometer is:

Gas Pressure	Nat. Gas	Propane
Low Pressure	1.6 mbar	2.7 mbar

5. Press the Economy button. The LED will then display 18 indicating that the low pressure has been recorded into memory.
6. Next press the SW1 switch twice. This puts the unit in high fire mode. PH will be displayed on the LED.
7. Set the high fire pressure using the UP and DOWN arrows and the manometer to get the following values.

Gas Pressure	Nat. Gas	Propane
High Pressure	5.7 mbar	9.2 mbar

8. Press the Economy button to enter the high fire pressure into the memory. The LED display will indicate 78.
9. Press the On/Off button again. The LED display goes blank and the unit returns to the normal OFF mode.
10. Reconfirm all pressure settings before putting unit back into operation. Disconnect manometer from the unit and replace the screws. Leak test all connections.
11. After completion of gas pipe connections all joints including the heater must be checked for gas tightness.
12. Visual check for proper main burner flame appearance.

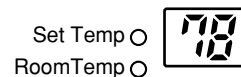
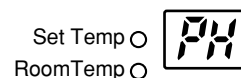
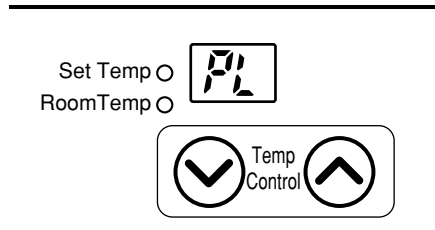

VISUAL CHECK

SATISFACTORY

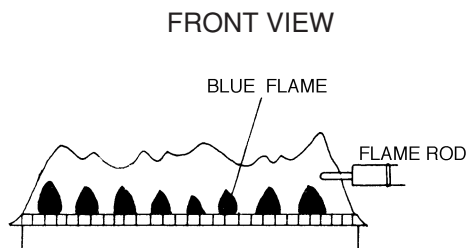

UNSATISFACTORY

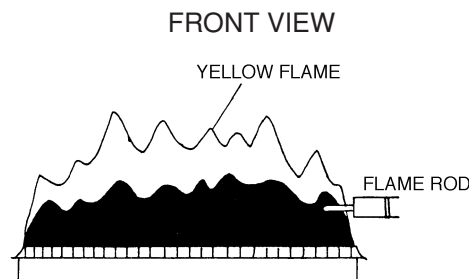

FITTING TOP SPACER AND WALL CLIP

Once Commissioning is complete the last thing to do is fix the top spacer.

1. Fit the spacer bracket to the top spacer.

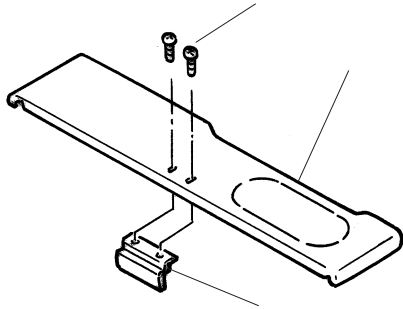

2. Secure Heater to wall.
Replace top spacer, clipping the spacer into the wall brackets at the same time as attaching it to the heater. Secure top spacer with the screws provided.

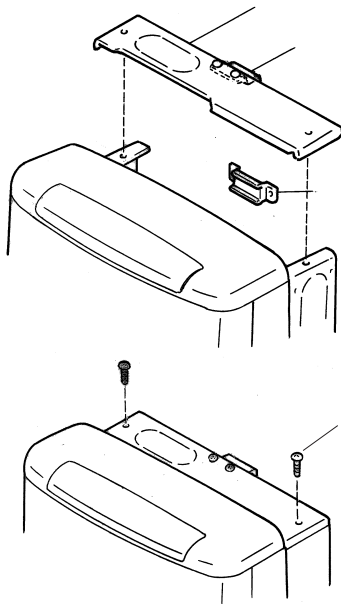

The heater is now secured to the wall.
Replace the air filter.

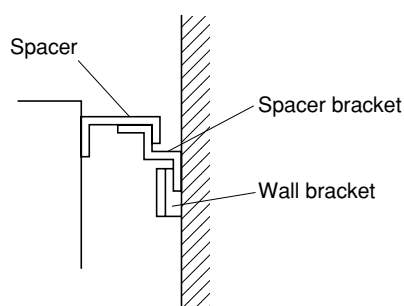

- **INSTRUCT CUSTOMER ON USE OF HEATER**

When you are satisfied that the appliance is operating correctly explain operation of heater to the customer.

Fault-Finding Procedure

If you are unable to get the heater to operate correctly contact Rinnai UK directly.

Some items are not covered by the manufacturer's warranty. Examples of these are: annual maintenance, carbon build-up on flame rods/igniter, dust, improper conversions, etc.

BLOCK DIAGRAM

Mark	PARTS NAME	Mark	PARTS NAME	Mark	PARTS NAME
MS	MAIN SWITCH	FR	FLAME ROD	SP	SPARKER
R, TH	THERMISTOR	RC	REMOTE CONTROLLER	SV1, 2	MAIN SOLENOID VALVE 1, 2
TF	THERMAL FUSE	CF	CONVECTION FAN	BL	COMBUSTION FAN MOTOR
F	FUSE	OH, TH	OVER HEAT THERMISTOR	RCR	REMOTE CONTROL RECEIVER
ER	ELECTRODE	OHS1, 2	OVER HEAT SWITCH 1, 2	TB	TERMINAL BLOCK
TR	TRANSFORMER	FM	CONVECTION FAN MOTOR	PS	PRESSURE SENSOR
				POV	MODULATING SOLENOID VALVE

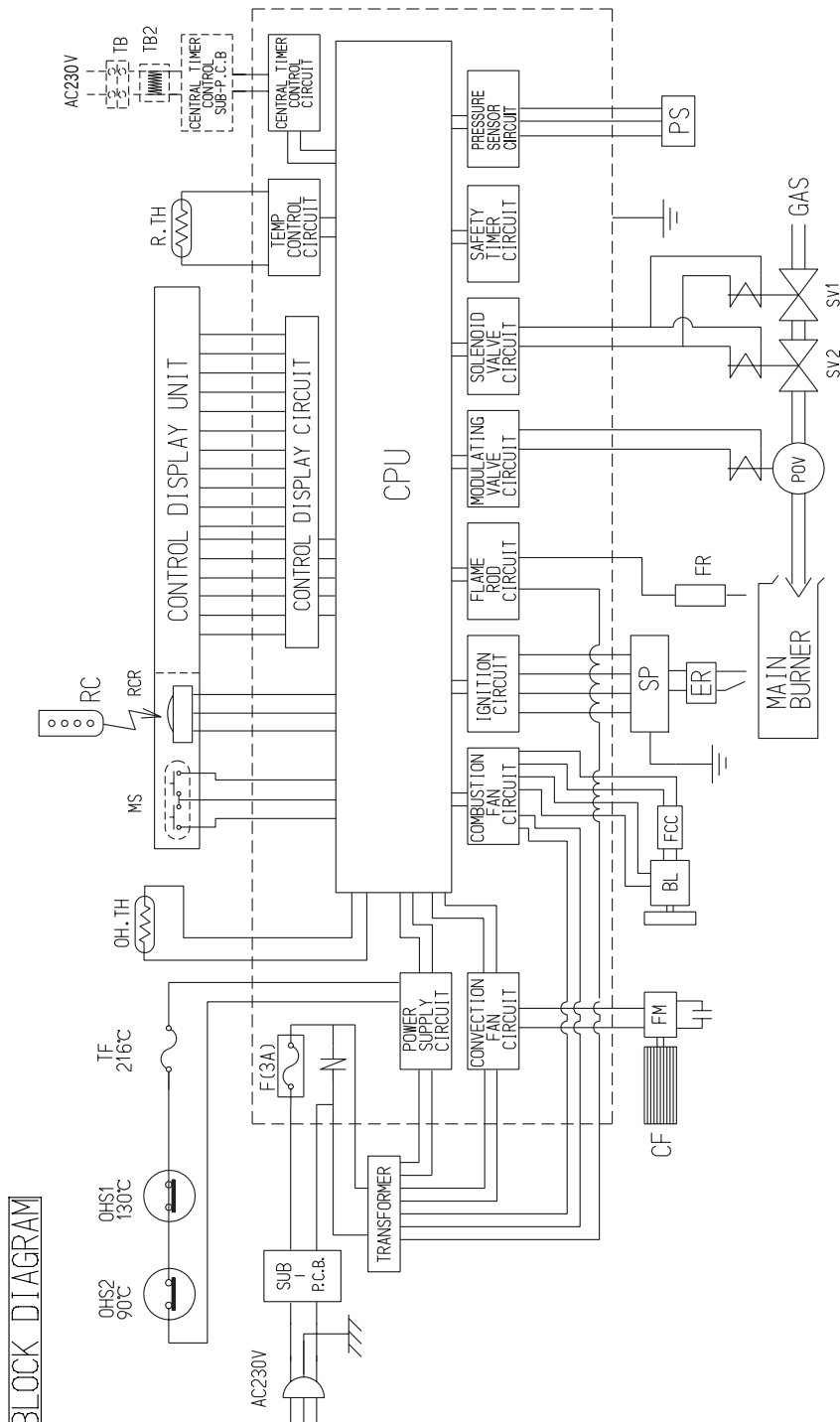

WIRING DIAGRAM

RHFE-308FTR

WIRING DIAGRAM

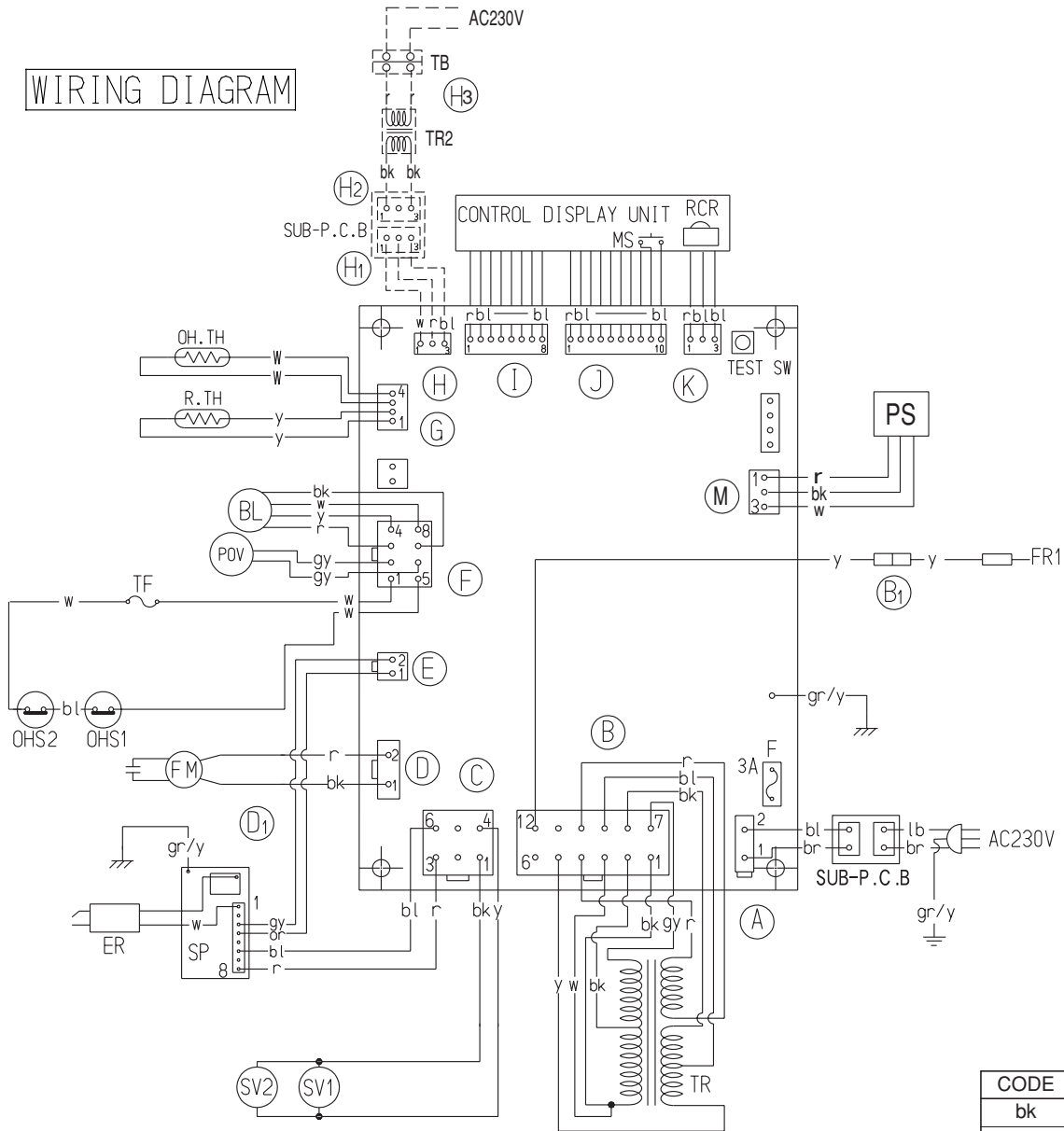

CODE	COLOUR
bk	black
bl	blue
gr	green
gr / y	green/yellow
pk	pink
r	red
w	white
y	yellow
gy	grey
or	orange
br	brown
lb	light blue

DIMENSIONS

(mm)

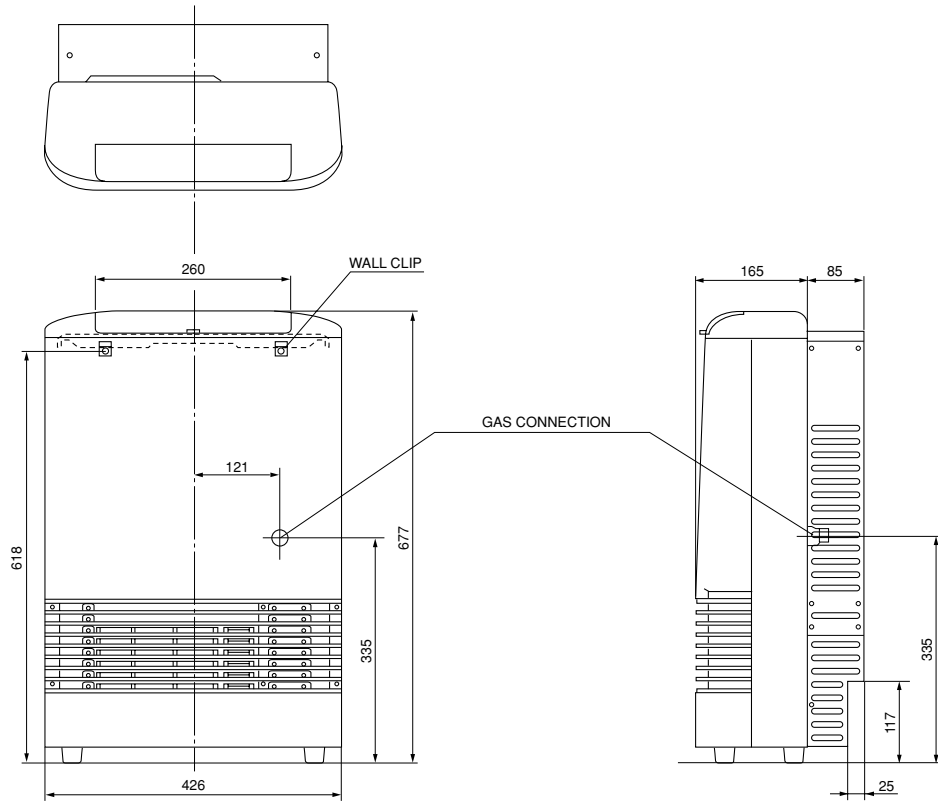

FLUE POSITION THROUGH WALL

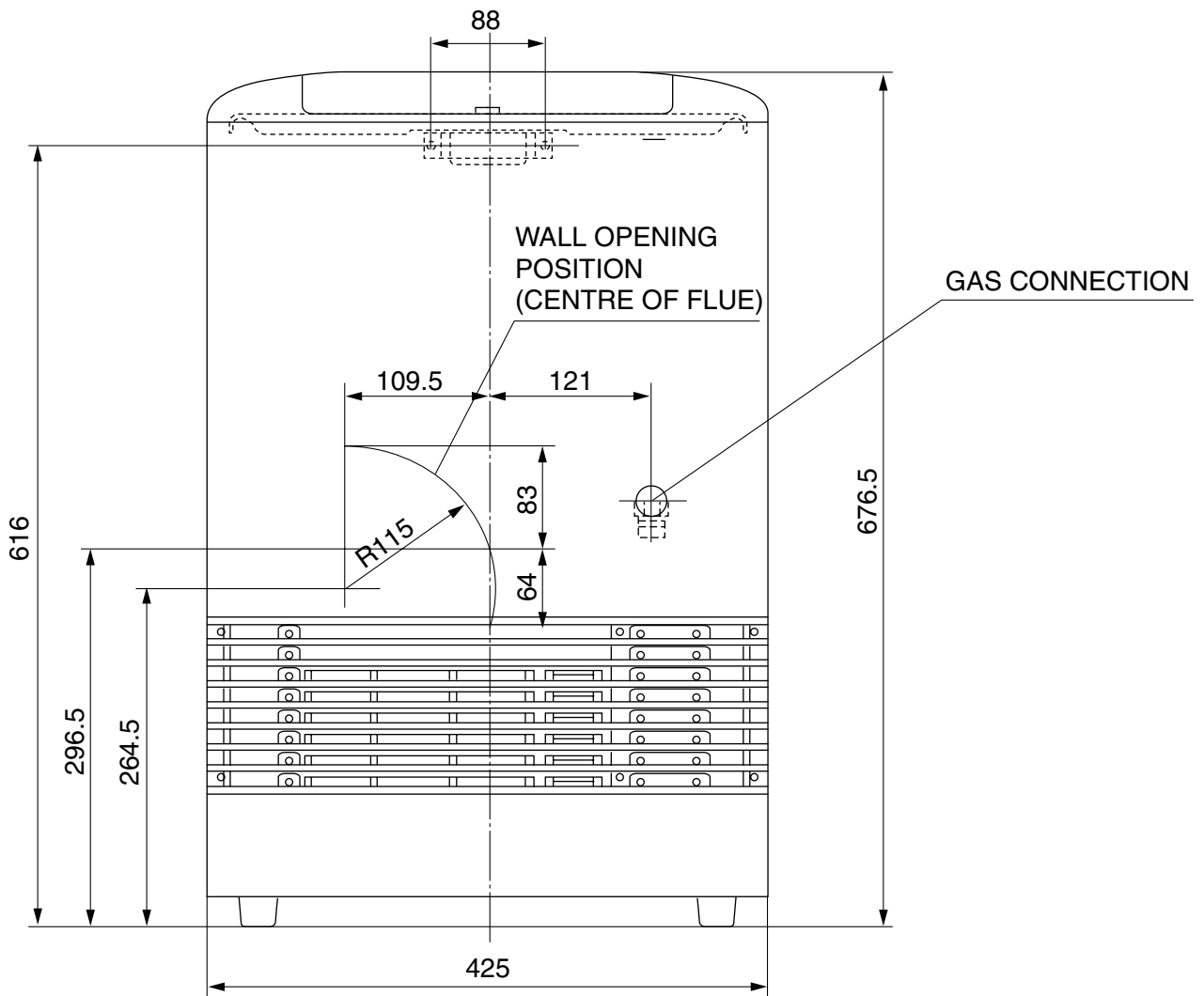

SPECIFICATION

Model	RHFE-308 FTR
Installation	Internal location only
Fuel	Natural Gas or LPG**
Control	Modulating
Input	3.4 kW
Output	2.92 kW
Exhaust type	Fanned flue
Max Flue Run	7.0m less 1m per 90 deg bend to a max. 3 bends
Ignition	Electronic Cont. Spark
Burner	Stainless steel
Weight	17Kg

Connections

Gas	1/2 BSP
Electrical Supply	230V AC 50Hz 1ph

** Separate models available for Natural gas or LPG fuel.

Rinnai are continually updating and improving products and reserve the right to alter model specifications without prior notice.

NOTES

SERVICE CONTACT

Rinnai UK LTD.

9 Christleton Court
Manor Park
Runcorn
Cheshire
WA7 1ST

Tel. 01928 531870

Fax. 01928 531880

E-mail. info@rinnaiuk.com

Web. www.rinnaiuk.com



105938

308F-1092
2007.04