

*If you have questions or comments, contact us.  
Pour toute question ou tout commentaire, nous contacter.  
Si tiene dudas o comentarios, contáctenos.*

**1-800-4-DEWALT • [www.dewalt.com](http://www.dewalt.com)**

**INSTRUCTION MANUAL  
GUIDE D'UTILISATION  
MANUAL DE INSTRUCCIONES**

INSTRUCTIVO DE OPERACIÓN, CENTROS DE SERVICIO Y PÓLIZA  
DE GARANTÍA. **ADVERTENCIA:** LÉASE ESTE INSTRUCTIVO ANTES  
DE USAR EL PRODUCTO.

---

# **DEWALT®**

---

**DP2800  
Pressure Washer  
Laveuse à pression  
Lavadora a presión**

## DP2800 PRESSURE WASHER

- |                                |                             |
|--------------------------------|-----------------------------|
| A. Handle assemble             | I. Engine dipstick/oil plug |
| B. Frame                       | J. High-pressure pump       |
| C. High-pressure hose          | K. Engine                   |
| D. Spray gun                   | L. Choke control            |
| E. Quick-connect spray wand    | M. Starter grip             |
| F. Panel assembly              | N. Fuel valve lever         |
| G. Nozzle holder               | O. Engine switch            |
| H. High-pressure pump oil plug | P. Gas cap                  |
|                                | Q. Throttle control lever   |

### ENGINE

Refer to the engine instruction manual for location and operation of other engine controls.

### Pump Specifications

#### CAT 3DX29GSI

Oil: Use DP70

Oil Capacity: 8.5 oz. (251 ml)

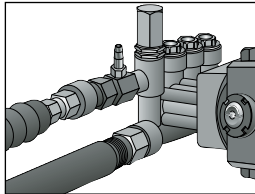
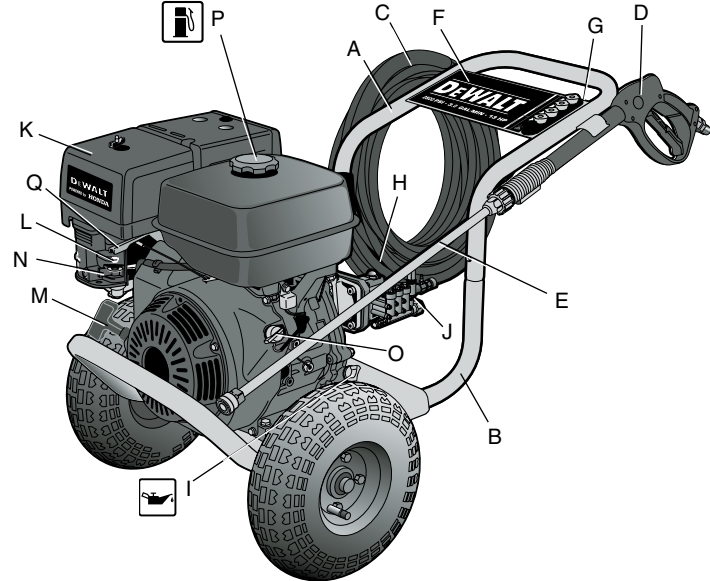

FIG. 1



### Specifications

MODEL	WEIGHT	HEIGHT	WIDTH	LENGTH	PSI MAX*	OPERATING PSI	GPM MAX*	OPERATING GPM	ENGINE
DP2800	97 lbs	26.5"	23"	40"	2800	2520	3.0	2.7	Honda 6.5 Hp GX200

\* Water flow and maximum pressure ratings determined in accordance with PWMA standard PW101.

## Definitions: Safety Guidelines

The definitions below describe the level of severity for each signal word. Please read the manual and pay attention to these symbols.

**▲DANGER:** Indicates an imminently hazardous situation which, if not avoided, **will** result in **death or serious injury**.

**▲WARNING:** Indicates a potentially hazardous situation which, if not avoided, **could** result in **death or serious injury**.

**▲CAUTION:** Indicates a potentially hazardous situation which, if not avoided, **may** result in **minor or moderate injury**.

**CAUTION:** Used without the safety alert symbol indicates a potentially hazardous situation which, if not avoided, **may** result in **property damage**.

IF YOU HAVE ANY QUESTIONS OR COMMENTS ABOUT THIS OR ANY DeWALT TOOL, CALL US TOLL FREE AT: **1-800-4-DeWALT (1-800-433-9258)**

## Important Safety Instructions

**▲WARNING:** Do not operate this unit until you read and understand this instruction manual and the engine instruction manual for safety, operation and maintenance instructions.

**▲WARNING:** When using this product basic precautions should always be followed, including the following:

1. Read all instructions before using the product.
2. To reduce the risk of injury, close supervision is necessary when a product is used near children.

3. Know how to stop the product and bleed pressures quickly. Be thoroughly familiar with the controls.
4. Stay alert – watch what you are doing.
5. Do not operate the product when fatigued or under the influence of alcohol or drugs.
6. Keep operating area clear of all persons.
7. Do not overreach or stand on unstable support. Keep good footing and balance at all times.
8. Follow the maintenance instructions specified in the manual.

**▲DANGER: RISK OF INJECTION OR SEVERE INJURY. KEEP CLEAR OF NOZZLE. DO NOT DIRECT DISCHARGE STREAM AT PERSONS. THIS PRODUCT IS TO BE USED ONLY BY TRAINED OPERATORS.**

**▲WARNING:** This product may not be equipped with a spark-arresting muffler. If the product is not equipped and will be used around flammable materials or on land covered with materials such as agricultural crops, forest, brush, grass or other similar items, then an approved spark arrester must be installed and is legally required in the state of California. It is a violation of California statutes section 130050 and/or sections 4442 and 4443 of the California Public Resources Code, unless the engine is equipped with a spark arrester, as defined in section 4442, and maintained in effective working order. Spark arresters are also required on some U.S. Forest Service land and may also be legally required under other statutes and ordinances.

**▲WARNING:** This product contains chemicals, including lead, known to the State of California to cause cancer, and birth defects or other reproductive harm. Wash hands after handling.

**SAVE THESE INSTRUCTIONS**



### **⚠ DANGER: RISK OF EXPLOSION OR FIRE**

#### **WHAT CAN HAPPEN**

- Spilled gasoline and its vapors can become ignited from cigarette sparks, electrical arcing, exhaust gases and hot engine components such as the muffler.
- Heat will expand fuel in the tank which could result in spillage and possible fire explosion.
- Operating the pressure washer in an explosive environment could result in a fire.
- Materials placed against or near the pressure washer can interfere with its proper ventilation features causing overheating and possible ignition of the materials.

#### **HOW TO PREVENT IT**

- Shut off engine and allow it to cool before adding fuel to the tank.
- Use care in filling tank to avoid spilling fuel. Move pressure washer away from fueling area before starting engine.
- Keep maximum fuel level 1/2" (12.7 mm) below bottom of filler neck to allow for expansion.
- Operate and fuel equipment in well-ventilated areas free from obstructions. Equip areas with fire extinguisher suitable for gasoline fires.
- Never operate pressure washer in an area containing dry brush or weeds.

- Muffler exhaust heat can damage painted surfaces, melt any material sensitive to heat (such as siding, plastic, rubber, vinyl or the pressure hose, itself), and damage live plants.
- Always keep pressure washer a minimum of 4' (1.2 m) away from surfaces (such as houses, automobiles or live plants) that could be damaged from muffler exhaust heat.
- Improperly stored fuel could lead to accidental ignition. Fuel improperly secured could get into the hands of children or other unqualified persons.
- Store fuel in an OSHA-approved container, in a secure location away from work area.
- Use of acids, toxic or corrosive chemicals, poisons, insecticides, or any kind of flammable solvent with this product could result in serious injury or death.
- Do not spray flammable liquids.



### **⚠ DANGER: RISK TO BREATHING (ASPHYXIATION)**

#### **WHAT CAN HAPPEN**

- Breathing exhaust fumes will cause serious injury or death! Engine exhaust contains carbon monoxide, an odorless and deadly gas.

#### **HOW TO PREVENT IT**

- Operate pressure washer in a well-ventilated area. Avoid enclosed areas such as garages, basements, etc.
- Never operate unit in a location occupied by humans or animals.

### **▲ RISK TO BREATHING (ASPHYXIATION) CONTINUED**

- Some cleaning fluids contain substances which could cause injury to skin, eyes or lungs.
- Use only cleaning fluids specifically recommended for high-pressure washers. Follow manufacturers recommendations. Do not use chlorine bleach or any other corrosive compound.



### **▲ DANGER: RISK OF FLUID INJECTION AND LACERATION**

#### **WHAT CAN HAPPEN**

- Your pressure washer operates at fluid pressures and velocities high enough to penetrate human and animal flesh, which could result in amputation or other serious injury. Leaks caused by loose fittings or worn or damaged hoses can result in injection injuries. **DO NOT TREAT FLUID INJECTION AS A SIMPLE CUT!** See a physician immediately!

#### **HOW TO PREVENT IT**

- Inspect the high-pressure hose regularly. Replace the hose immediately if it is damaged, worn, has melted from contacting the engine, or shows any signs of cracks, bubbles, pinholes, or other leakage. Never grasp a high-pressure hose that is leaking or damaged.
- Never touch, grasp or attempt to cover a pinhole or similar water leak on the high-pressure hose. The stream of water IS under high pressure and WILL penetrate skin.
- Never place hands in front of nozzle.

- Direct spray away from self and others.
- Make sure hose and fittings are tightened and in good condition. Never hold onto the hose or fittings during operation.
- Do not allow hose to contact muffler.
- Never attach or remove wand or hose fittings while system is pressurized.
- To relieve system pressure, shut off engine, turn off water supply and pull gun trigger until water stops flowing.
- Use only accessories rated equal to or higher than the rating of the pressure washer.

- Injuries can result if system pressure is not reduced before attempting maintenance or disassembly.



### **⚠ DANGER: RISK OF INJURY FROM SPRAY**

#### **WHAT CAN HAPPEN**

- High-velocity fluid spray can cause objects to break, propelling particles at high speed.
- Light or unsecured objects can become hazardous projectiles.

#### **HOW TO PREVENT IT**

- Always wear ANSI-approved Z87.1 safety glasses. Wear protective clothing to protect against accidental spraying.
- Never point wand at or spray people or animals.
- Always secure trigger lock when wand is not in service to prevent accidental operation.
- Never permanently secure trigger in pull-back (open) position.



### **⚠ DANGER: RISK OF UNSAFE OPERATION**

#### **WHAT CAN HAPPEN**

- Unsafe operation of your pressure washer could lead to serious injury or death to you or others.

#### **HOW TO PREVENT IT**

- Do not use chlorine bleach or any other corrosive compound.
- Become familiar with the operation and controls of the pressure washer.
- Keep operating area clear of all persons, pets and obstacles.
- Do not operate the product when fatigued or under the influence of alcohol or drugs. Stay alert at all times.
- Never defeat the safety features of this product.
- Do not operate machine with missing, broken or unauthorized parts.
- Never leave wand unattended while unit is running.

### **⚠ DANGER: RISK OF UNSAFE OPERATION (CONTINUED)**

- If proper starting procedure is not followed, engine can kickback causing serious hand and arm injury.
- If engine does not start after two pulls, squeeze trigger of gun to relieve pump pressure. Pull starter cord slowly until resistance is felt. Then pull cord rapidly to avoid kickback and prevent hand or arm injury.
- The spray gun/wand is a powerful cleaning tool that could look like a toy to a child.
- Keep children away from the pressure washer at all times.
- Reactive force of spray will cause gun/wand to kickback, and could cause the operator to slip or fall or misdirect the spray. Improper control of gun/wand can result in injuries to self and others.
- Do not overreach or stand on an unstable support.
- Do not use pressure washer while standing on a ladder.
- Grip gun/wand firmly with both hands. Expect the gun to kickback when triggered.



### **⚠ DANGER: RISK OF INJURY OR PROPERTY DAMAGE WHEN TRANSPORTING OR STORING**

#### **WHAT CAN HAPPEN**

- Fuel or oil can leak or spill and could result in fire or breathing hazard. Serious injury or death can result. Fuel or oil leaks will damage carpet, paint or other surfaces in vehicles or trailers.

#### **HOW TO PREVENT IT**

- If pressure washer is equipped with a fuel shut-off valve, turn the valve to the OFF position before transporting to avoid fuel leaks. If pressure washer is not equipped with a fuel shut-off valve, drain the fuel from tank before transporting. Only transport fuel in an OSHA-approved container. Always place pressure washer on a protective mat when transporting to protect against damage to vehicle from leaks. Remove pressure washer from vehicle immediately upon arrival at your destination.



### ⚠ **WARNING: RISK OF BURSTING**

#### WHAT CAN HAPPEN

- Over inflation of tires could result in serious injury and property damage.

#### HOW TO PREVENT IT

- Use a tire pressure gauge to check the tires pressure before each use and while inflating tires; see the tire sidewall for the correct tire pressure.

**NOTE:** Air tanks, compressors and similar equipment used to inflate tires can fill small tires similar to these very rapidly. Adjust pressure regulator on air supply to no more than the rating of the tire pressure. Add air in small increments and frequently use the tire gauge to prevent over inflation.



### ⚠ **WARNING: RISK OF HOT SURFACES**

#### WHAT CAN HAPPEN

- Contact with hot surfaces, such as engines exhaust components, could result in serious burn.

#### HOW TO PREVENT IT

- During operation, touch only the control surfaces of the pressure washer. Keep children away from the pressure washer at all times. They may not be able to recognize the hazards of this product.



### ⚠ **WARNING: RISK OF CHEMICAL BURN**

#### WHAT CAN HAPPEN

- Use of acids, toxic or corrosive chemicals, poisons, insecticides, or any kind of flammable solvent with this product could result in serious injury or death.

#### HOW TO PREVENT IT

- Do not use acids, gasoline, kerosene, or any other flammable materials in this product. Use only household detergents, cleaners and degreasers recommended for use in pressure washers.
- Wear protective clothing to protect eyes and skin from contact with sprayed materials.





**⚠ WARNING: RISK OF ELECTRICAL SHOCK**

**WHAT CAN HAPPEN**

- Spray directed at electrical outlets or switches, or objects connected to an electrical circuit, could result in a fatal electrical shock.

**HOW TO PREVENT IT**

- Unplug any electrically operated product before attempting to clean it. Direct spray away from electric outlets and switches.



**⚠ WARNING: RISK OF INJURY FROM LIFTING**

**WHAT CAN HAPPEN**

- Serious injury can result from attempting to lift too heavy an object.

**HOW TO PREVENT IT**

- The pressure washer is too heavy to be lifted by one person. Obtain assistance from others before lifting.

**SAVE THESE INSTRUCTIONS FOR FUTURE USE**

**INSTALLATION**

**Pressure Washer Assembly (Fig. 1)**

1. Place handle assembly (A) onto frame, depress the snap buttons, and slide the handle assembly onto the frame (B) until snap buttons are secured in place.

**⚠ CAUTION:** Risk of personal injury. Avoid placing hands between handle and frame when assembling to prevent pinching.

2. Attach high-pressure hose (C) to spray gun (D). Make sure it is secure.
3. Connect wand (E) to spray gun. Make sure connection is secure.

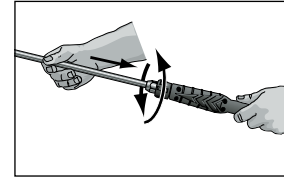
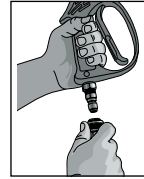
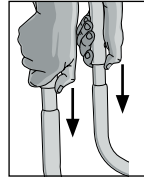

4. Place the nozzle holder (G) onto the panel assembly (F) and push each nozzle holder into place.
5. Remove the five colored quick-connect nozzles from the plastic bag and insert them into correct grommet on the nozzle holder. Nozzles are color coded to match colored nozzles on panel assembly.

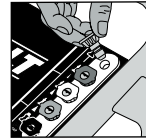
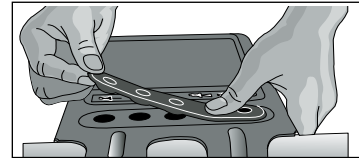

**NOTE:** The high-pressure pump was filled with oil at the factory. Always check oil level before using (refer to **Maintenance** for more information).

**⚠ WARNING:** Risk of bursting. Use a tire pressure gauge to check the tires pressure before each use and while inflating tires; see the tire sidewall for the correct tire pressure.

**NOTE:** Air tanks, compressors and similar equipment used to inflate tires can fill small tires similar to these very rapidly. Adjust pressure regulator on air supply to no more than the rating of the tire pressure. Add air in small increments and frequently use the tire gauge to prevent over inflation.

## OPERATION

### Pressure Adjustments

The pressure setting is preset at the factory to achieve optimum pressure and cleaning. To lower the pressure, follow these instructions.



1. Back away from the surface to be cleaned. The further away you are, the less the pressure will be on the surface to be cleaned.
2. Change to the 40° nozzle (white). This nozzle delivers a less powerful stream of water and a wider spray pattern. Refer to **Spray Wand Nozzles**.



**CAUTION:** DO NOT attempt to increase pump pressure. A higher pressure setting than the factory set pressure may damage pump.

3. Reduce the speed of the gasoline engine (RPM). Slow the engine down and the water pressure will go down with it.

### Spray Wand Nozzles (Fig. 1)

The nozzles for the spray wand are stored in the nozzle holder (G) on the panel assembly (F). Colors on the panel identify nozzle location and spray pattern. Refer to the following chart to choose the correct nozzle for the job to be performed.

Nozzle Color	Spray Pattern	Uses	Surfaces*
Red	0° 	powerful pinpoint for very intense cleaning	metal or concrete; DO NOT use on wood
Yellow	15° 	intense cleaning of small areas	metal, concrete or wood

Green	25° 	intense cleaning of larger areas	metal, concrete or wood
White	40° 	covers wide areas of cleaning	metal, concrete, wood or vinyl
Black	low pressure 	applies cleaning solutions	metal, concrete, wood or vinyl
* <b>CAUTION:</b> The high-pressure spray from your pressure washer is capable of causing damage to surfaces such as wood, glass, automobile paint, auto striping and trim, delicate objects such as flowers and shrubs. Before spraying, check the item to be cleaned to assure yourself that it is strong enough to resist damage from the force of spray.			

### CHANGING NOZZLES ON SPRAY WAND

**▲ DANGER:** Risk of fluid injection. Do not direct discharge stream toward persons, unprotected skin, eyes or any pets or animals. Serious injury will occur.

**▲ WARNING:** Flying objects could cause risk of serious injury. **DO NOT** attempt to change nozzles while pressure washer is running. Turn engine off before changing nozzles.

1. Pull quick-connect coupler back and insert nozzle.
2. Release quick-connect coupler and twist nozzle to make sure it is secure in coupler.

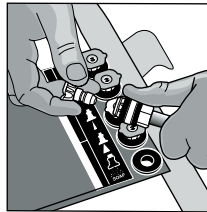

**▲ WARNING:** Flying object could cause risk of serious injury. Ensure nozzle is completely inserted in quick-connect socket and quick-connect snap ring is fully engaged (forward) before squeezing gun trigger.

## Chemicals and Cleaning Solvents

Applying chemicals or cleaning solvents is a low-pressure operation.

**NOTE:** Use only soaps and chemicals designed for pressure washer use. **Do not use bleach.**

### TO APPLY CHEMICALS AND SOLVENTS

1. Press chemical hose (S) onto barbed fitting located near high pressure hose connection of pump as shown.
2. Place the other end of chemical hose with filter on it into the container holding chemical/cleaning solution.

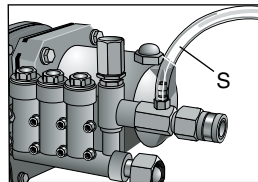

**NOTE:** For every 7 gallons of water pumped 1 gallon of chemical/cleaning solution will be used.

3. Install low-pressure (black) nozzle into quick connect fitting of spray wand, refer **Spray Wand Nozzles**.
4. After use of chemicals, place chemical hose into container of clean water and draw clean water through chemical injection system to rinse system thoroughly. If chemicals remain in the pump it could be damaged. Pumps damaged due to chemicals will not be covered under warranty.

**NOTE:** Chemicals and soaps will not siphon when spray wand is in the high-pressure setting.

## Starting

**▲ WARNING:** To reduce the risk of injury, read the pressure washer instruction manual and the engine instruction manual before starting pressure washer.

**▲ DANGER:** Risk of fluid injection and laceration. When using the high-pressure setting, **DO NOT** allow the high-pressure spray to come in contact with unprotected skin, eyes, or with any pets or animals. Serious injury will occur.

- Your washer operates at fluid pressures and velocities high enough to penetrate human and animal flesh, which could result in amputation or other serious injury. Leaks caused by loose fittings or worn or damaged hoses can result in injection injuries. **DO NOT TREAT FLUID INJECTION AS A SIMPLE CUT!** See a physician immediately!

**▲ WARNING:** Risk of fire, asphyxiation and burning. **NEVER** fill fuel tank when engine is running or hot. Do not smoke when filling fuel tank.

- **NEVER** fill fuel tank completely. Fill tank to 1/2" (12.7 mm) below bottom of filler neck to provide space for fuel expansion. Wipe any fuel spillage from engine and equipment before starting engine.
- **NEVER** run engine indoors or in enclosed, poorly ventilated areas. Engine exhaust contains carbon monoxide, an odorless and deadly gas.
- **DO NOT** let hoses come in contact with very hot engine muffler during or immediately after use of your pressure washer. Damage to hoses from contact with hot engine surfaces will **NOT** be covered by warranty.

**CAUTION:** **NEVER** pull water supply hose to move pressure washer. This could damage hose and/or pump inlet.

- **DO NOT** use hot water, use cold water only.

- NEVER turn water supply off while pressure washer engine is running or damage to pump will result.
- DO NOT stop spraying water for more than two minutes at a time. Pump operates in bypass mode when spray gun trigger is not pressed. When the temperature inside the pump rises too high the thermal relief valve (T) will open and release a gush of water in an effort to lower the temperature inside the pump. The thermal relief valve will then close. If pump is left in bypass mode for more than two minutes internal components of the pump can be damaged.

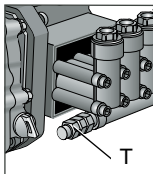

### START-UP PROCEDURE

1. In a well-ventilated outdoor area, add fresh, high-quality, unleaded gasoline with a pump octane rating of 86 or higher. Do not overfill. Wipe up spilled fuel before starting the engine. Refer to engine instruction manual for correct procedure.
2. Check engine oil level. Refer to the engine instruction manual for correct procedure.
3. Connect the water hose to the water source. Turn the water source on to remove all air from the hose. When a steady stream of water is present, turn the water source off.
4. Verify the filter screen (U) is in water inlet of pump. The cone side faces out.
5. Connect the cold water source (V) to pump inlet.

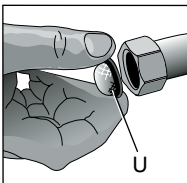

**NOTE:** Water source must provide a minimum of 5 gallons per minute at 20 PSI.

**▲WARNING:** To reduce the possibility of contamination always protect against backflow when connected to a potable water system.

6. Connect high-pressure hose (C) to pump outlet.
7. If applying a chemical or cleaning solution, refer to **Chemicals and Cleaning Solvents**.
8. Turn the water source on.

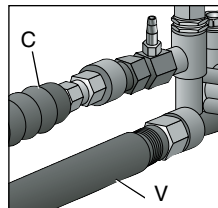

**CAUTION:** Risk of property damage. Failure to do so could cause damage to the pump.

9. Remove all air from the pump and high pressure hose by depressing trigger until a steady stream of water is present.
10. Start engine. Refer to the engine instruction manual for correct procedure.

**▲WARNING:** Risk of unsafe operation. If engine does not start after two pulls, squeeze trigger of gun to relieve pump pressure. Pull starter cord slowly until resistance is felt. Then pull cord rapidly to avoid kickback and prevent hand or arm injury.

11. Depress trigger on gun to start water flow.

**▲WARNING:** Risk of unsafe operation. Stand on a stable surface and grip gun/wand firmly with both hands. Expect the gun to kickback when triggered.

12. Release trigger to stop water flow.

**▲DANGER:** Risk of injury from spray. Engage the trigger lock (W) when gun is not in use to prevent accidental spraying.

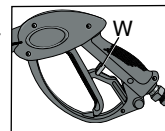

13. Adjust spray for the task being performed by changing quick connect nozzle. Refer to **Spray Wand Nozzles**.

### Shutting Down

1. If chemicals were applied, place the chemical hose into a container of clean water and draw clean water through chemical injection system to rinse system thoroughly.

**CAUTION:** Risk of property damage Failure to do so could cause damage to the pump.

2. Turn engine off. Refer to the engine instruction manual.

**CAUTION:** Risk of property damage. NEVER turn water supply off while pressure washer engine is running or damage to pump will result.

3. Turn water source off.

4. Pull trigger on spray gun to relieve any water pressure in hose or spray gun.

5. Refer to **Storage** for proper storage procedures.

## MAINTENANCE

**▲ WARNING:** Risk of burning. When performing maintenance, you may be exposed to hot surfaces, water pressure or moving parts that can cause serious injury or death.

**▲ WARNING:** Risk of fire. Always disconnect, spark plug wire, let the engine cool and release all water pressure before performing any maintenance or repair. The engine contains flammable fuel. Do not smoke or work near open flames while performing maintenance.

To ensure efficient operation and longer life of your pressure washer, a routine maintenance schedule should be prepared and followed. If the pressure washer is used in unusual conditions, such as high temperatures or dusty conditions, more frequent maintenance checks will be required.

## Engine

Consult the engine instruction manual for the manufacturer's recommendations for any and all maintenance.

**NOTE:** The pressure washer frame is equipped with an oil drain hole to help make changing the engine oil easier.

## Pump

**NOTE:** The pump was filled with oil at the factory.

1. Change pump oil after the first 10 hours of operation and every 250 hours thereafter.

### TO CHECK OIL

1. The oil level should come to the dot in the middle of the sight glass (X).

### HOW TO CHANGE

#### PUMP OIL

1. Loosen pump oil fill plug (H).
2. Place a container under the oil drain plug (Y).
3. Remove pump oil drain plug.
4. After oil is drained, replace oil drain plug. Tighten securely.
5. Remove pump oil plug and fill with 8.5 oz. (251 ml) of DP70 pump oil. If DP70 is not available use 30W non-detergent oil.
6. Replace pump oil plug and tighten securely.

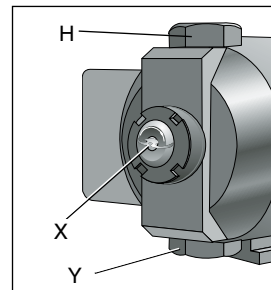

## Nozzle Cleaning

If the nozzle becomes clogged with foreign materials, such as dirt, excessive pressure may develop. If the nozzle becomes partially clogged or restricted, the pump pressure will pulsate. Clean the nozzle immediately using the nozzle kit supplied and the following instructions:

1. Shut off the pressure washer and turn off the water supply.
2. Pull trigger on gun handle to relieve any water pressure.

3. Disconnect the spray wand from the gun.
4. Remove the high-pressure nozzle from the spray wand. Remove any obstructions with the nozzle cleaning tool (Z) provided and back flush with clean water.

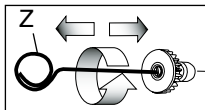

5. Direct water supply into spray wand to back flush loosened particles for 30 seconds.

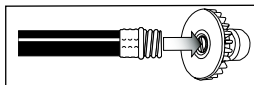

6. Reassemble the nozzle to the wand.
7. Reconnect spray wand to gun then turn on water supply.
8. Start pressure washer and place spray wand into high pressure setting to test.

## To Clean the Water Inlet Filter

This filter screen (U) should be checked periodically and cleaned if necessary.

1. Remove the filter screen (U) by grasping the end and removing it from water inlet of pump.
2. Clean filter by flushing it with water on both sides.
3. Reinsert filter into water inlet of pump. Cone side faces out.

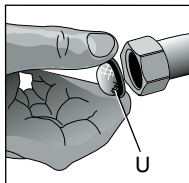

**NOTE:** Do not operate pressure washer without filter properly installed.

## To Remove Tires

1. Using a 1/8" hex head wrench loosen set screw in hub collar.
2. Slide hub collar from axle and remove the tire.

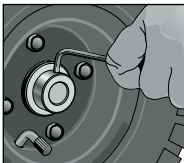

## STORAGE

### Engine

Consult the engine instruction manual for the manufacturer's recommendations for storage.

### Pump

The manufacturer recommends using a pump protector/winterizer, such as DP80 when storing the unit for more than 30 days and/or when freezing temperatures are expected. DP80 is available at the store where the pressure washer was purchased. If a pump protector/winterizer is not available, RV antifreeze or windshield washer fluid needs to be run through the pump as outlined in the steps below.

**NOTE:** Using a pump protector/ winterizer, RV antifreeze or windshield washer fluid is to provide proper lubrication to the internal seals of the pump regardless of temperature or environment.

1. Obtain a funnel, 6 oz. (172 ml) of RV antifreeze or windshield washer fluid, and 16–36" (91 cm) of garden hose with a male hose connector attached to one end.

**CAUTION:** Risk of property damage. Use only RV antifreeze. Any other antifreeze is corrosive and can damage pump.

2. Disconnect spark plug wire.
3. Connect length of garden hose to water inlet of pump.
4. Add RV antifreeze or windshield washer fluid to hose as shown.
5. Pull engine starter rope slowly several times until antifreeze/washer fluid comes out of high-pressure hose connection of pump.
6. Remove garden hose from water inlet of pump.
7. Reconnect spark plug wire.

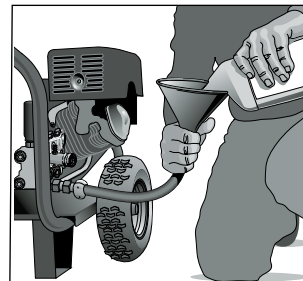

## Pressure Washer

1. Drain all water from high-pressure hose, coil it and store it in cradle of the pressure washer handle.
2. With nozzle pointed down and the spray gun and wand in a vertical position, squeeze trigger to drain all water from spray gun and wand. Store in gun holder.
3. Store chemical hose so it is protected from damage.
4. If space is needed, handles may be removed and attached as shown.

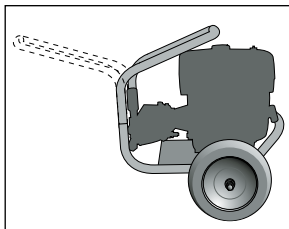

**▲CAUTION:** Risk of personal injury. Avoid placing hands between handle and frame when assembling to prevent pinching.

## ACCESSORIES

Recommended accessories for use with your tool are available for purchase from your local dealer or authorized service center. If you need assistance in locating any accessory for your tool, please contact DeWALT Industrial Tool Co., 701 East Joppa Road, Baltimore, MD 21286, call 1-800-4-DeWALT (1-800-433-9258) or visit our website [www.dewalt.com](http://www.dewalt.com).

**▲CAUTION:** The use of any other accessory not recommended for use with this tool could be hazardous. Use only accessories rated equal to or higher than the rating of the pressure washer.

## SERVICE INFORMATION

Please have the following information available for all service calls:  
Model Number \_\_\_\_\_ Serial Number \_\_\_\_\_  
Date and Place of Purchase \_\_\_\_\_

### Repairs

To assure product SAFETY and RELIABILITY, repairs, maintenance and adjustment should be performed by a DeWALT factory service center, a DeWALT authorized service center or other qualified service personnel. Always use identical replacement parts.

### Limited Warranty

DeWALT pressure washers are warranted for one year from the date of purchase. DeWALT will repair, without charge, any defects due to faulty materials or workmanship. For further detail of warranty coverage and warranty repair information, visit [www.dewalt.com](http://www.dewalt.com) or call 1-800-4-DeWALT (1-800-433-9258). This warranty does not apply to accessories or damage caused where repairs have been made or attempted by others. This warranty gives you specific legal rights and you may have other rights which vary in certain states or provinces. The product's engine is covered by the engine manufacturer's warranty.

**LATIN AMERICA:** This warranty does not apply to products sold in Latin America. For products sold in Latin America, see country specific warranty information contained either in the packaging, call the local company or see website for warranty information.

**FREE WARNING LABEL REPLACEMENT:** If your warning labels become illegible or are missing, call 1-800-4-DEWALT for a free replacement.

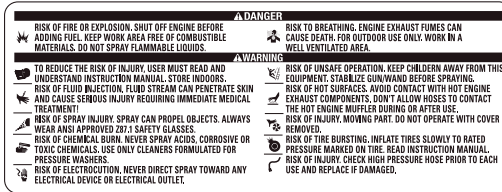
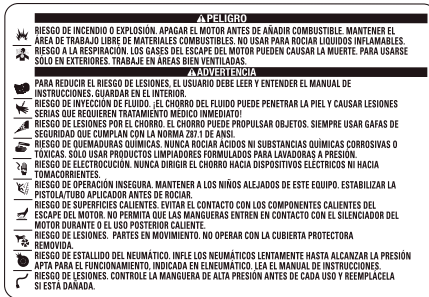
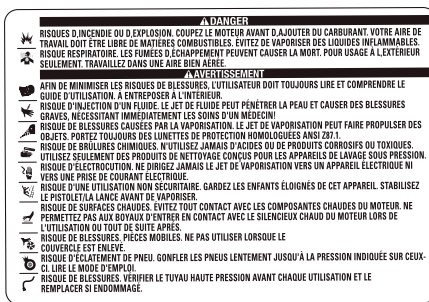
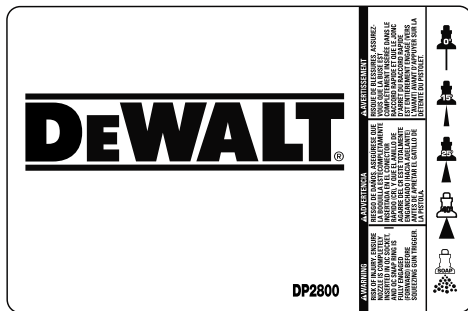



## **Glossary**

**Bypass mode:** Allows water to re-circulate within pump when the gun trigger is not pulled.

**Chemical hose:** Feeds cleaning agents into the pump to mix with the water. Refer to **Chemicals and Cleaning Solvents**.

**Chemical injection system:** Mixes cleaners or cleaning solvents with water to improve cleaning effectiveness.

**Choke control:** Opens and closes carburetor choke valve.

**CU:** Cleaning Units. GPM multiplied by PSI. (GPM x PSI = CU)

**Fuel valve lever:** Opens/closes connection between fuel tank and carburetor.

**GPM:** Gallons Per Minute. The unit of measure for the flow rate of water.

**PSI:** Pounds per Square Inch. The unit of measure for water pressure. Also used for air pressure, hydraulic pressure, etc.

**Quick-connect spray wand:** Allows the user to quickly change out high-pressure nozzles. Refer to **Spray Wand Nozzles**.

**Thermal relief valve:** When the temperature inside the pump rises too high the valve will open and release a gush of water in an effort to lower the temperature inside the pump. The valve will then close.

**Water supply:** All pressure washers must have a source of water. The minimum requirements for a water supply are 20 PSI and 5 gallons per minute.

## **Troubleshooting Guide**

This section provides a list of the more frequently encountered malfunctions, their causes and corrective actions. The operator or maintenance personnel can perform some corrective actions, and others may require the assistance of a qualified DEWALT technician or your dealer.

<b>Problem</b>	<b>Code</b>
Engine will not start .....	1, 2, 3, 4, 5, 6, 7, 8
<i>(refer to the engine's instruction manual for further engine troubleshooting)</i>	
No or low pressure (initial use) .....	9, 10, 11, 12, 13, 14, 15, 16
Will not draw chemicals .....	16, 17, 18, 19, 20, 21
No or low pressure (after period of normal use).....	22, 23, 24
Water leaking at gun/spray wand connection .....	25, 26
Water leaking at pump .....	25, 26, 27, 28
Oil leaking at pump.....	29, 30, 31, 32, 33, 34, 35
Pump Pulsates .....	12

## Troubleshooting Codes

CODE	POSSIBLE CAUSE	POSSIBLE SOLUTION
1	No fuel.	Add fuel.
2	Low oil.	Add required amount of oil.
3	Pressure builds up after two pulls on the recoil starter or after initial use.	Squeeze gun trigger to relieve pressure.
4	Choke lever in the NO CHOKE position.	Move choke to the CHOKE position.
5	Spark plug wire not attached.	Attach spark plug wire.
6	Engine ON/OFF switch in OFF position.	Place engine ON/OFF switch in ON position.
7	Choke lever in the CHOKE position on a <i>hot</i> engine or an engine that has been exposed to thermal heat for a long period of time.	Move choke to the NO CHOKE position.
8	Fuel valve closed.	Move the fuel valve lever to the OPEN position.
9	Spray wand not in high pressure.	See <b>Spray Wand Nozzles</b> under <i>Operation</i> .
10	Low water supply.	Water supply must be at least 5 GPM @ 20 PSI.
11	Leak at high-pressure hose fitting.	Repair leak. Apply sealant tape if necessary.
12	Nozzle obstructed.	See <b>Nozzle Cleaning</b> under <i>Maintenance</i> .
13	Water filter screen clogged.	Remove and clean filter.
14	Air in hose.	Turn off the engine, then the water source. Disconnect the water source from the pump inlet and turn the water source on to remove all air from the hose. When there is a steady stream of water present, turn water source off. Reconnect water source to pump inlet and turn on water source. Squeeze trigger to remove remaining air.
15	Choke lever in the CHOKE position.	Move choke to the NO CHOKE position.
16	High-pressure hose is too long.	Use high-pressure hose under 100 feet (30.48 m). Lengthen water supply hose instead of high-pressure hose.

**(Troubleshooting Codes cont.)**

CODE	POSSIBLE CAUSE	POSSIBLE SOLUTION
17	Spray wand not in low pressure.	See <b>Spray Wand Nozzles</b> under <i>Operation</i> .
18	Chemical filter clogged.	Clean filter.
19	Chemical screen not in cleaning solution.	Make sure end of chemical hose is fully submerged into cleaning solution.
20	Chemical too thick.	Dilute chemical. Chemical should be the same consistency as water.
21	Worn seal or packing.	Have parts cleaned or replaced by authorized service center.
22	Chemical build up in chemical injector.	Have replaced by an authorized service center.
23	Worn or obstructed valves.	Have replaced by authorized service center.
24	Worn unloader piston.	Have replaced by authorized service center.
25	Worn or broken o-ring.	Check and replace.
26	Loose hose connection.	Tighten.
27	Piston packings worn.	Have replaced by authorized service center.
28	Pump head or tubes damaged from freezing.	Have replaced by authorized service center.
29	Oil seals worn.	Have replaced by authorized service center
30	Loose drain plug.	Tighten.
31	Worn drain plug o-ring	Check and replace.
32	Worn fill plug o-ring.	Check and replace.
33	Pump overfilled.	Check for correct amount.
34	Incorrect oil used.	Drain and fill with correct amount and type of oil.
35	Vent plug is clogged.	Clean vent plug; blow air through it to remove any blockage. If problem persists, replace plug.

DeWALT Industrial Tool Co., 701 Joppa Road, Baltimore, MD 21286  
(JAN06) Form No. A16505 DP2800 Copyright © 2006 DeWALT

The following are trademarks for one or more DeWALT power tools: the yellow and black color scheme; the “D” shaped air intake grill; the array of pyramids on the handgrip; the kit box configuration; and the array of lozenge-shaped humps on the surface of the tool.