

# SHARP®

## DVD Video Player

### MODEL

# DV-S1(RU)

## OPERATION MANUAL



Please read this Operation Manual carefully before using your DVD Video Player.

The region number for this DVD player is 5.



NTSC/PAL



## SAFETY INFORMATION

### Note:

This Player can be used only where the power supply is AC 110V-240V, 50/60Hz. It cannot be used elsewhere.

### CAUTION:

**USE OF CONTROLS OR ADJUSTMENTS OR PERFORMANCE OF PROCEDURES OTHER THAN THOSE SPECIFIED HEREIN MAY RESULT IN HAZARDOUS RADIATION EXPOSURE.**

**AS THE LASER BEAM USED IN THIS PLAYER IS HARMFUL TO THE EYES, DO NOT ATTEMPT TO DISASSEMBLE THE CABINET. REFER SERVICING TO QUALIFIED PERSONNEL ONLY.**

### WARNING:

**TO REDUCE THE RISK OF FIRE OR ELECTRIC SHOCK, DO NOT EXPOSE THIS EQUIPMENT TO RAIN OR MOISTURE.**

**TO REDUCE THE RISK OF FIRE OR ELECTRIC SHOCK, AND ANNOYING INTERFERENCE, USE THE RECOMMENDED ACCESSORIES ONLY.**

### Laser Diode Properties

**Material: GaAs**

**Wave length: DVD 650 nm / CD 780 nm**

**Emission Duration: Continuous**

**Laser output: Max. 0.8 mW**

### Power Cord Protection

To avoid any malfunctions of the Player, and to protect against electric shock, fire or personal injury, please observe the following.

- Hold the plug firmly when connecting or disconnecting the AC power cord.
- Keep the AC power cord away from heating appliances.
- Never put any heavy object on the AC power cord.
- Do not attempt to repair or reconstruct the AC power cord in any way.

- This Player is classified as a CLASS 1 LASER product.
- The CLASS 1 LASER PRODUCT label is located on the rear cover.
- This product contains a low power laser device. To ensure continued safety do not remove any cover or attempt to gain access to the inside of the product. Refer all servicing to qualified personnel.

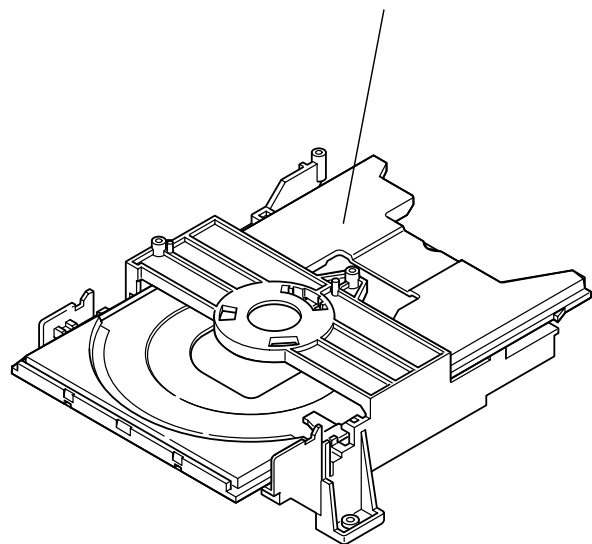
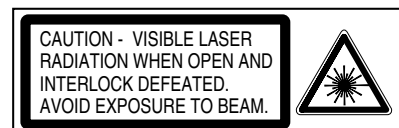
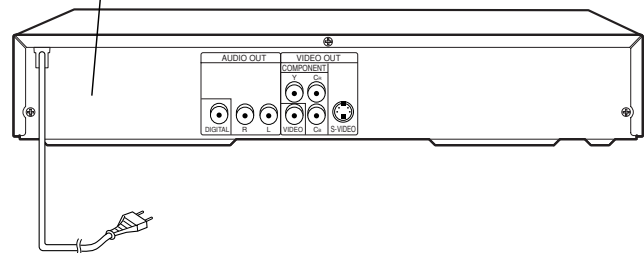

### Location and Handling

- Do not place your Player in enclosed spaces or do not cover it to prevent excessive temperatures inside the Player.
- Do not place the Player in direct sunlight, or near heat sources.
- Keep the Player away from strong magnetic objects.
- Do not place any object containing water or other liquids on the Player. In the event that liquid should enter the cabinet, unplug the Player immediately and contact the retailer or service centre approved by SHARP immediately.
- Do not remove the Player cabinet. Touching parts inside the cabinet could result in electric shock and/ or damage to the Player. For service and adjustment inside the cabinet, call a qualified dealer or service centre approved by SHARP.

### Nonuse Periods

When the Player is not being used, switch the Player to the Standby mode.

When left unused for a long period of time, the Player should be unplugged from the household AC outlet.

### No Fingers or Other Objects Inside

Do not put any foreign object on the disc tray.

### Stacking

Place the unit in a horizontal position, and do not place anything heavy on it.

### Condensation

Moisture may form on the pickup lens in the following conditions:

- immediately after a heater has been turned on.
- in a steamy or very humid room.
- when the Player is suddenly moved from a cold environment to a warm one.

If moisture forms inside this Player, it may not operate properly.

In this case, turn on the power and wait about one hour for the moisture to evaporate.

### Cleaning

Unplug your Player before cleaning. Use a damp cloth for cleaning. Do not use cleaning fluids or aerosols which could enter the Player and cause damage, fire, or electrical shock. These substances may also deteriorate the finish of your Player.

### If there is Noise Interference on the TV While a Broadcast is being Received

Depending on the reception condition of the TV, interference may appear on the TV monitor while you watch a TV broadcast and the unit is left on. This is not a malfunction of the Player or the TV. To watch a TV broadcast, turn off the Player.

### Service

Do not attempt to service this Player yourself. Please refer any service to the nearest service centre approved by SHARP.

### Copyright

Audio-visual material may consist of copyrighted works which must not be recorded without the authority of the owner of the copyright. Please refer to relevant laws in your country.

### Copy Protection

This Player supports Macrovision copy protection. On DVDs that include a copy protection code, if the contents of the DVD are copied using a VCR, the copy protection code prevents the videotape copy from playing normally.

Apparatus Claims of U.S. Patent Nos. 4,631,603, 4,577,216, 4,819,098 and 4,907,093 licensed for limited viewing uses only.

This product incorporates copyright protection technology that is protected by method claims of certain U.S. patents and other intellectual property rights owned by Macrovision Corporation and other rights owners. Use of this copyright protection technology must be authorized by Macrovision Corporation, and is intended for home and other limited viewing uses only unless otherwise authorized by Macrovision Corporation. Reverse engineering or disassembly is prohibited.

### Recommended Measures for Optimum Picture Excellence

The Player is a precision device that is constructed using extremely accurate technology. Soiling or friction affecting the pickup lens or disc drive can impair the image quality. At the worst, neither video nor audio will be played back. To obtain optimum picture quality, the Player should be checked (cleaning and replacement of some parts) every 1,000 hours. Note that this period varies depending on the environment (temperature, humidity, dust, etc.) in which the Player is used. Contact your authorized Sharp supplier for details.

Do not attempt to clean the pickup lens yourself.

## PRECAUTIONS

### SUPPLIED ACCESSORIES

- Remote control
- Two R6 (AA) batteries
- Operation Manual
- VIDEO/AUDIO cables

### SYMBOLS USED IN THIS MANUAL

The following symbols appear below in some headings and notes in this manual, with the following meanings!

#### DVD

: Description refers to playback of DVD video discs.

#### CD

: Description refers to playback of audio CDs.

#### MP3

: Description refers to playback of MP3 discs.

#### VCD

: Description refers to playback of video CDs.

### PLAYABLE DISCS

This DVD player conforms to the PAL colour system. Also you can play discs recorded with the NTSC system via a PAL system TV set.

•Some discs include region codes as shown below.



•The number inside the symbol refers to a region of the world, and a disc encoded in a specific region format can only be played back on DVD player with the same region code.

### ABOUT THE PBC FUNCTION OF VIDEO CD

This unit conforms to ver.1.1 and ver.2.0 of VIDEO CD standard, with PBC function.

Ver.1.1 (without PBC function): You can enjoy playback picture as well as music CD.

Ver.2.0 (with PBC function): When using a VIDEO CD with PBC function, "PBC" appears on the display.

What is PBC? "PBC" stands for the PlayBack Control. You can play interactive software using a menu screens. Refer to instructions of VIDEO CD.

For Customer Use:

Read carefully the information located at the bottom of your DVD player and enter below the Serial No. Retain this information for future reference.

Model No. DVD player

Serial No. \_\_\_\_\_

## TABLE OF CONTENTS

<b>SAFETY INFORMATION .....</b>	<b>2</b>	Repeat .....	14
<b>PRECAUTIONS.....</b>	<b>4</b>	REPEAT TITLE/CHAPTER .....	14
SUPPLIED ACCESSORIES.....	4	REPEAT TRACK .....	14
SYMBOLS USED IN THIS MANUAL .....	4	REPEAT A-B.....	14
PLAYABLE DISCS.....	4	Programme.....	14
<b>FUNCTIONAL OVERVIEW .....</b>	<b>6</b>	Random Playback .....	14
FRONT PANEL.....	6	MP3 Playback.....	15
REAR VIEW .....	6	On Screen Information .....	15
Display Message .....	6	Track Selection.....	15
REMOTE CONTROL.....	7	Random Playback .....	15
Loading the Batteries .....	7	Programmed.....	15
<b>SETTING UP YOUR DVD PLAYER.....</b>	<b>8</b>	Audio Language .....	15
Connecting to a TV or a stereo TV that has		Stereo Sound Mode .....	15
COMPONENT VIDEO in jacks.....	8	Subtitle Language.....	16
Connecting a TV Equipped with S-VIDEO Input or		Camera Angle.....	16
VIDEO/AUDIO Input Jacks.....	9	Changing the On-Screen Display.....	16
Connecting to Audio Equipment.....	9	Parental Control.....	16
Playing 2 channel audio .....	9	IF YOU FORGET THE PASSWORD .....	16
Playing Dolby Digital (5.1 channel), DTS or		Parental Level.....	17
MPEG audio .....	11	Marker Setup Screen .....	17
<b>DVD OPERATION .....</b>	<b>12</b>	<b>DVD SETUP .....</b>	<b>18</b>
Basic Playback .....	12	Audio Setting .....	18
General Features.....	12	Black Level Setting.....	18
Disc menus.....	12	Display Setting.....	18
Title Menu .....	12	Language Setting .....	19
Pause .....	12	<b>TROUBLESHOOTING .....</b>	<b>20</b>
Step by Step playback .....	13	<b>SPECIFICATIONS.....</b>	<b>21</b>
Resume .....	13	<b>MAINTENANCE .....</b>	<b>21</b>
Fast Forward / Reverse Search .....	13		
Slow Motion.....	13		
Zoom .....	13		
Track.....	13		
Title/chapter .....	14		
Time Search .....	14		

## FUNCTIONAL OVERVIEW

### FRONT PANEL

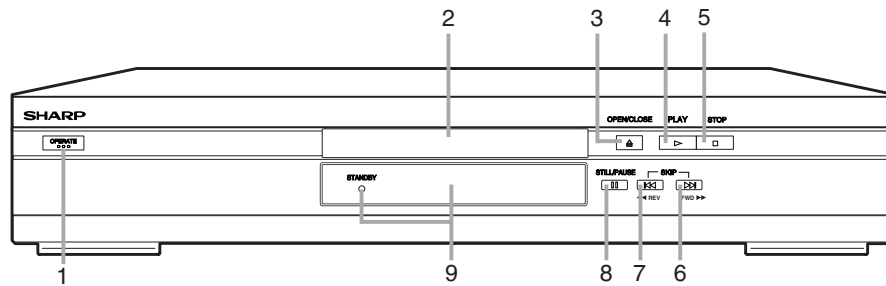

### REAR VIEW

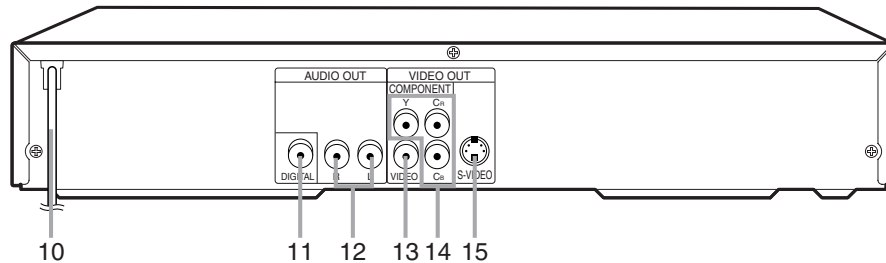

1. **OPERATE**  
to switch the player to ON or OFF
2. **Disc tray**
3. **OPEN/CLOSE**  
to open/close the disc tray
4. **PLAY**  
to start, pause or resume disc playback
5. **STOP**  
to stop playback
6. **FWD/SKIP**  
goes to next chapter or track during playback; press and hold for three seconds for a forward search
7. **SKIP/REV**  
goes to previous chapter or track during playback; press and hold for three seconds for a reverse search
8. **STILL/PAUSE**  
to pause the current disc operation
9. **Display, Remote Sensor, STANDBY LED**
10. **MAINS (AC Power Cord)**  
connect to a standard AC outlet
11. **DIGITAL (Digital audio out)**  
connect to AUDIO inputs of a digital (coaxial) audio equipment
12. **AUDIO OUT (Left/Right)**  
connect to AUDIO inputs of an amplifier, receiver or stereo system
13. **VIDEO OUT**  
connect to the Video Input of a TV
14. **COMPONENT VIDEO OUT**  
connect to a TV with Component video in jacks
15. **S-VIDEO Out**  
connect to a TV with S-Video inputs

**Caution: Do not touch the inner pins of the jacks on the rear panel. Electrostatic discharge may cause permanent damage to the unit.**

### Display Message

	Power on
	No disc inserted
	Tray open
	Tray closed
	Loading the Disc
	Power off

## REMOTE CONTROL

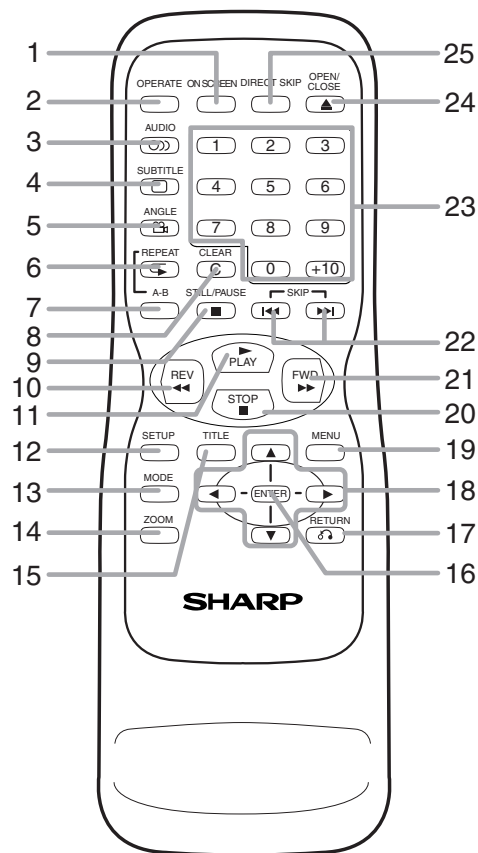

1. **ON SCREEN**  
to access or remove the display screen during DVD or Audio CD playback
2. **OPERATE**  
switch DVD player ON or OFF
3. **AUDIO**  
to choose audio languages or sound modes
4. **SUBTITLE**  
subtitle language DVD selector
5. **ANGLE**  
select DVD camera angle
6. **REPEAT**  
repeat chapter, track, title, disc
7. **A-B REPEAT**  
repeat a specific segment
8. **CLEAR**  
to reset the setting
9. **STILL/PAUSE**  
pause playback temporarily / frame-by-frame playback
10. **◀**  
to view DVD picture in fast reverse motion
11. **PLAY**  
to start a DVD disc playback
12. **SETUP**  
to access or remove the DVD setup menu
13. **MODE**  
to set up programmed or random playback (Audio CD)  
to set the black level during DVD playback
14. **ZOOM**  
enlarge DVD video image
15. **TITLE**  
to display title menu of a disc
16. **ENTER**  
acknowledge menu selection
17. **RETURN**  
to return previous or remove setup menu
18. **Arrow(▼ ▲ ► ◀)**  
(left/right/up/down) select an item in the menu
19. **MENU**  
to display the menu of the DVD disc
20. **STOP**  
to stop a DVD disc playback
21. **▶▶**  
to view DVD picture in fast forward motion
22. **SKIP ◀◀, ▶▶**  
to skip chapter/tracks
23. **0-9 numerical key pad**  
select numbered items in a menu  
**+10**  
use this button to enter number 10 and above
24. **OPEN/CLOSE**  
to open/close the disc tray
25. **DIRECT SKIP**  
to locate a desired point

### Loading the Batteries

1. Open the battery compartment cover.
2. Insert two R6 (AA) batteries, with each one oriented correctly.
3. Close the cover.

#### NOTES

- Do not mix alkaline and manganese batteries.
- Do not mix old and new batteries.

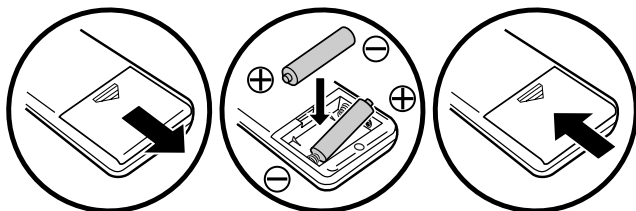

## SETTING UP YOUR DVD PLAYER

### CAUTION:

- Be sure to turn off the Player and equipment to be connected before connecting.
- Read through the operation manual for the equipment to be connected.
- Be sure that the colours of the jacks and plugs match up when using a VIDEO/AUDIO cables.
- Be sure to keep the Player connection cables separate from the TV antenna cable when you install the Player, because it may cause electrical interference when you are watching television programs.

### Connecting to a TV or a stereo TV that has component video in jacks

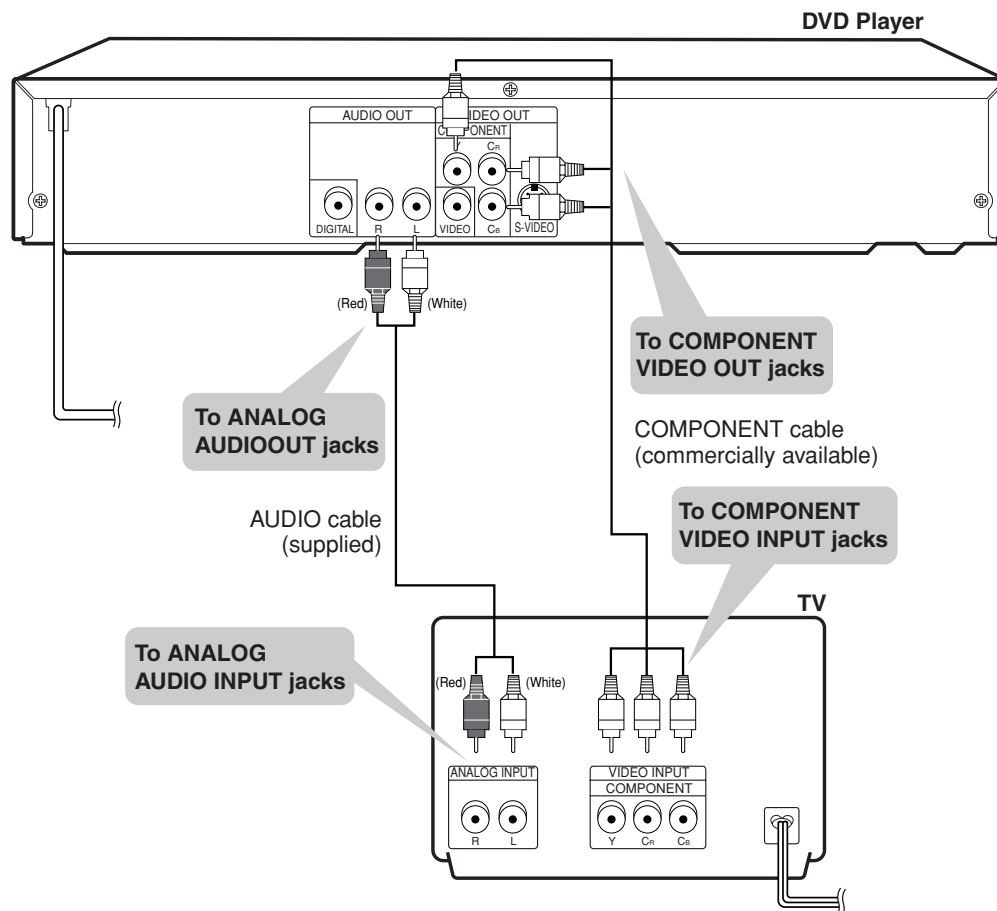

### CAUTION:

- Do not connect the Player to a VCR. If you view the Picture on your TV after making the connections shown on the right, a picture noise may appear. Connect the Player to your TV directly.

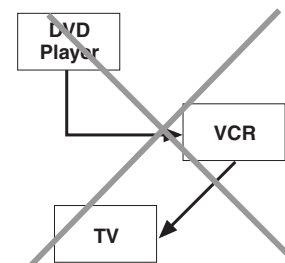



## SETTING UP YOUR DVD PLAYER

### Connecting a TV Equipped with S-VIDEO Input or VIDEO/AUDIO Input Jacks

When you want to achieve a better video image by connecting a TV equipped with an S-VIDEO input connector to the Player, you should use an S-VIDEO cable (commercially available) to connect the TV to the Player.

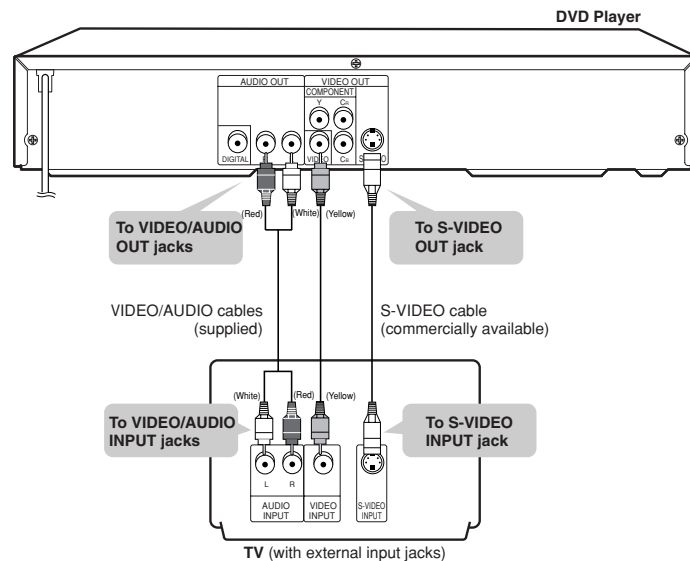

- When the Player is connected to a TV using both a VIDEO cable and an S-VIDEO cable, only the S-VIDEO connection is enabled (the VIDEO connection is disabled).
- You will not be able to hear all of the sound being output by the Player if you use the VIDEO/AUDIO cables (supplied) to a monaural TV that has only one AUDIO input jack.

#### NOTE:

- Be sure that the colours of the jacks and plugs match up when connecting the cable.
- Connect the Player directly to the TV. If you attempt to view video on a TV connected via a VCR, the copy protection function will scramble the picture.
- If you want to listen to the audio through audio equipment, connect only the S-VIDEO or VIDEO cable to the TV.

### Connecting to Audio Equipment

Connecting the Player to audio equipment provides normal stereo sound plus powerful stereo sound enhanced by Dolby Digital (5.1 channel), DTS, and MPEG Audio.

#### Playing 2 channel audio

##### ■ Analogue Connection

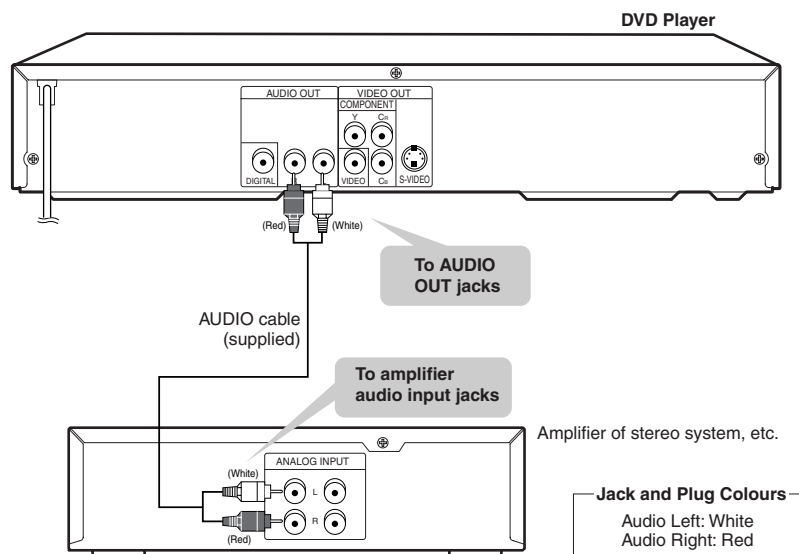

### ■ Digital Connection

You can make this connection using a coaxial digital cable.

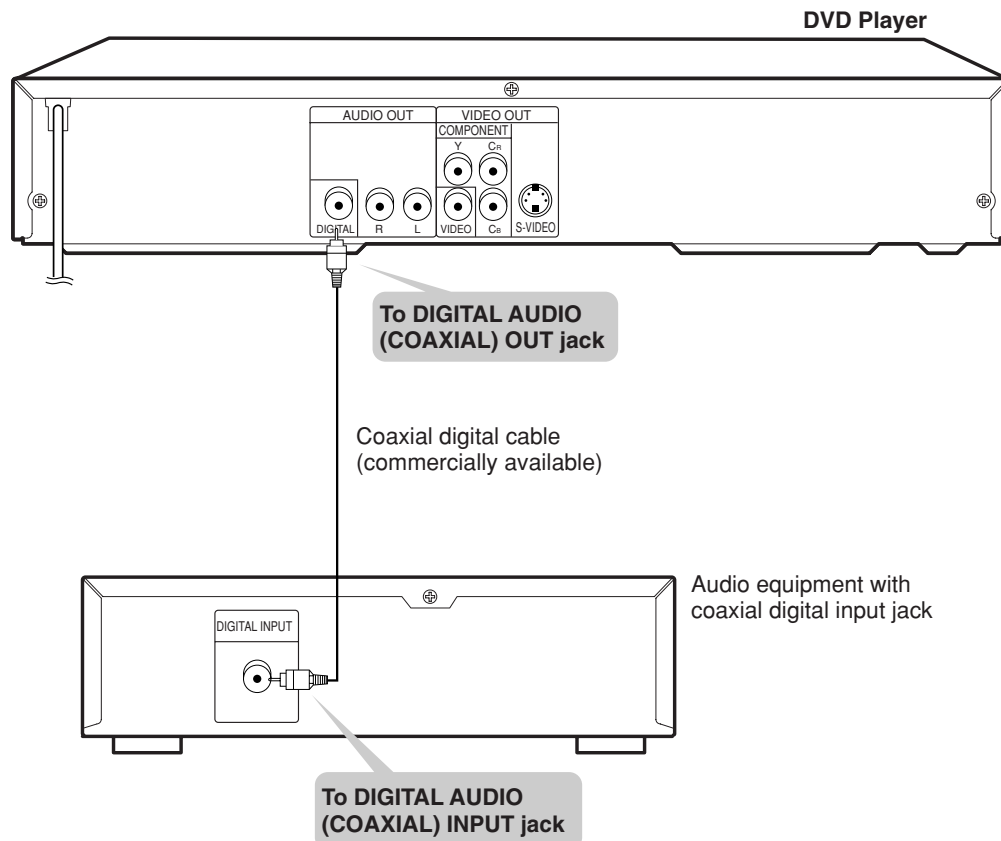

### Digital Connection to an MD to Record a CD

Some Audio CDs have a short silent section between musical tracks. When sound from discs such as these is digitally recorded by connecting the Player directly to a digital recorder (such as an MD player), the music may be recorded continuously and track numbers may be lost.

### ■ Digital Connection to Audio Equipment or MD Player without a Dolby Digital Decoder

- Audio CD  
Play the disc as you normally would, with the audio mode set to "L+R". With a digital connection, audio of a disc recorded with DTS sounds abnormal in this case.
- DVD  
With a digital connection, audio cannot be produced from a DVD recorded in Dolby Digital (5.1 channel), Dolby Surround (Pro Logic), DTS or MPEG Audio.  
You should use an analogue connection to play Dolby Digital (5.1 channel) and MPEG Audio. (Dolby Surround (Pro Logic) and DTS audio cannot be produced with an analogue connection).  
Discs with linear PCM audio should play normally.

## SETTING UP YOUR DVD PLAYER

### Playing Dolby Digital (5.1 channel), DTS or MPEG audio

Connecting an amplifier with a Dolby Digital/DTS/MPEG Audio digital surround processor or a Dolby Digital/DTS/MPEG Audio surround processor to your Player's coaxial digital jack provides richer and more powerful audio play.

#### ■ Connection to a processor or amplifier with a coaxial digital input jack

You can make this connection using a coaxial digital cable.

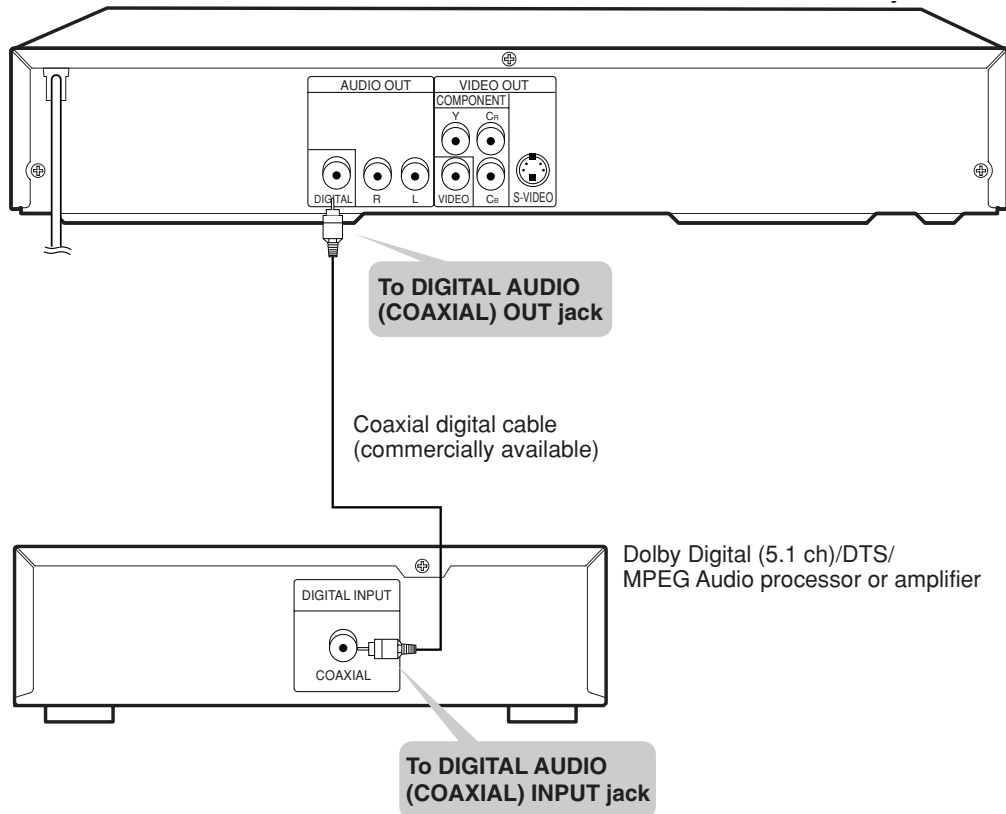

#### NOTES:

- This connection is not possible if the processor or amplifier to which you want to connect does not have a coaxial digital input jack.
- ANALOG AUDIO OUT of the DVD player is not available on the DTS audio.

**“DTS” and “DTS Digital Out” are trademarks of Digital Theater Systems, Inc.**

**Manufactured under license from Dolby Laboratories. “Dolby” and the double-D symbol are trademarks of Dolby Laboratories.**

#### HOW TO CONNECT TO A TV WITHOUT AUDIO/VIDEO INPUT JACKS

If your TV does not have RCA type audio and video input jacks it is still possible to connect this DVD player to your TV's 75-ohm coaxial antenna terminal using a commercially available Stereo Audio/Video RF Modulator. Connect the audio and video outputs of the DVD player to the audio and video inputs on the RF Modulator, and then connect the coaxial output of the RF Modulator (usually marked “TO TV”) to the 75 ohm coaxial antenna terminal on your TV. Follow the instruction supplied with the RF Modulator for more details.

If your TV's 75 ohm coaxial antenna terminal is already occupied by an antenna or cable box connection, remove that cable from your TV's antenna terminal and reconnect it to the coaxial antenna input terminal of the RF Modulator (usually marked “ANT IN”), then connect the RF modulator to your TV's antenna terminal as described above.

#### NOTE

- The picture quality from DVD discs will not be as good if the DVD player is connected to the TV's antenna terminal through an RF Modulator.

## Basic Playback

DVD CD VCD

### Getting started

- Turn on the power of the TV, amplifier and any other components which are connected to the DVD.
- Make sure the TV and audio receiver (commercially available) are set to the correct channel.
- When you play NTSC disc, the NTSC signal will convert to a modified PAL signal.

#### 1 Press OPERATE.

- "P-ON" will appear briefly on the display panel.

#### 2 Press OPEN/CLOSE to open disc loading tray.

#### 3 Place the chosen disc in the tray, with the label facing up.

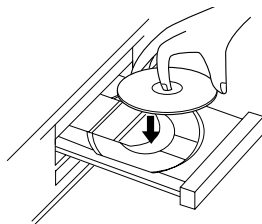

#### 4 Press PLAY.

- Playback starts automatically.

#### 5 Press STOP to stop playback.

### NOTE:

- DVDs may have a region code. Your DVD player will not play discs that have a region code different from the region code of your DVD player.

## General Features

DVD or Video CDs may contain menus to navigate the disc and access special features. Press the appropriate numerical key or use **Arrow** (▼/▲/▶/◀) to highlight your selection in the DVD menu and press **ENTER** to confirm.

### NOTE:

- Unless stated, all operations described are based on remote control use. Some operations can be carried out using the menu bar on the TV screen.

### Cancelling PBC (for playback of a Video CD)

#### 1 Insert a Video CD. (Playback will start automatically.)

#### 2 Press STOP.

#### 3 Enter track number of your choice with numerical key pad.

#### 4 PBC is now cancelled and the playback of the Video CD will start.

## Disc menus

DVD

#### 1 Press MENU.

- The DVD's main menu will appear.

#### 2 If a title menu is no available, Ⓝ symbol may appear on the TV screen.

#### 3 If disc menu is available on the disc, audio language, subtitle options, chapters for the title and other options will appear for selection.

#### 4 Press Arrow (▼/▲/▶/◀) to select an item, and ENTER to confirm selection.

## Title Menu

DVD

#### 1 Press TITLE.

- The title menu will appear.

#### 2 If a title menu is no available, Ⓝ symbol may appear on the TV screen.

#### 3 Press Arrow (▼/▲/▶/◀) to select an item, and ENTER to confirm selection.

- Playback will begin at the selected Title.

VCD

#### 1 The title menu will appear.

#### 2 Press numerical key pad to select the menu. Playback will start.

## Pause

DVD CD VCD

#### 1 During playback, press PAUSE.

- Playback will pause and sound will be muted.

#### 2 To continue playback, press PLAY.

## Step by Step playback

DVD VCD

- 1** During playback, press **PAUSE**.
  - Playback will pause and sound will be muted.
- 2** The disc goes forward by one frame each time **PAUSE** is pressed.
- 3** To exit step by step playback, press **PLAY**.

## Resume

DVD CD VCD

- 1** During playback, press **STOP**.
  - Resume message will appear on the TV screen.
- 2** Press **PLAY**, playback will resume from the point at which playback was stopped.
  - To cancel resume, press **STOP** twice.

### NOTE

- Some Video CDs with PBC function resume playback from the beginning of the track.

## Fast Forward / Reverse Search

DVD

- 1** During playback, press **▶▶** or **◀◀** repeatedly to select the required forward or reverse speed: x2, x8, x30, x60.
- 2** To return to normal playback, press **PLAY**.

VCD

- During playback, press **▶▶** or **◀◀** repeatedly to select the required forward or reverse speed: x2, x8, x30.

CD

- Use **▶▶** or **◀◀** to select the required forward or reverse at x16 the normal playback speed.

## Slow Motion

DVD VCD

- 1** During playback, press **PAUSE**.
- 2** Press **▶▶**.
  - Slow motion playback will begin and sound will be muted.
- 3** Press **▶▶** repeatedly to select the required speed: 1/16, 1/8, 1/2 of the normal playback.
- 4** To return to normal playback, press **PLAY**.

## Zoom

DVD VCD

The Zoom function allows you to enlarge the video image and to pan through the enlarged image.

- 1** Press **ZOOM** during playback.
  - Playback will continue.
- 2** Press **ZOOM** repeatedly to select the required zoom factor: x2, x4 or OFF.
- 3** Use **Arrow** (**▼**/**▲**/**▶**/**◀**) to move the zoomed picture across the screen.
- 4** To exit zoom mode, press **ZOOM** to OFF in the menu bar.

## Track

CD VCD

There are three ways to begin playback on an Audio CD at a specific Track.

### Using the Numerical key pads

- 1** Press **numerical key pad** to enter the desired Track number.
  - Playback will start at the selected track.
  - For single digit tracks (1-9), press a single number (eg. track 3, press 3).
  - To play track 26, press +10, 2, 6 on the numerical key pad.

### Using the DIRECT SKIP

- 1** Press **DIRECT SKIP**.
  - The track search display appears.
- 2** Within 30 seconds, select a desired track number using **numerical key pad**.
  - Playback will start at the selected track.

### NOTE:

- **DIRECT SKIP** doesn't function when you play the Video CD with PBC function.

### Using the SKIP ◀◀▶▶

- 1** Press **SKIP ▶▶** to move to the next track.
- 2** Press **SKIP ▶▶** or **◀◀** repeatedly to skip subsequent or to return of the current tracks.
  - Track number will appear briefly on the DVD display panel.
  - When playback is paused, pressing SKIP will start the track playing automatically.

### NOTE:

- **SKIP ◀◀▶▶** are not available when playback is stopped.

## DVD OPERATION

### Title/chapter

DVD

- 1 Press **DIRECT SKIP** to display the Title/Chapter Search on the TV screen.
- 2 Enter the desired title/chapter number using **numerical key pad**.

### Time Search

DVD

CD

VCD (without PBC function)

- 1 During playback, press **DIRECT SKIP** twice to display the Time Search on the TV screen.
- 2 Within 30 seconds, enter a desired disc time using **numerical key pad**.
  - Playback will start at the specified time.
- 3 Press **CLEAR** to erase the incorrect input.

### Repeat

- REPEAT are available only during playback.

#### REPEAT TITLE/CHAPTER

DVD

- To repeat the current chapter, press **REPEAT**.  
**REPEAT CHAPTER** appears on the TV screen.
- To repeat the current title, press **REPEAT** twice.  
**REPEAT TITLE** appears on the TV screen.
- To exit Repeat mode, press **REPEAT** three times.  
**REPEAT OFF** appears on the TV screen.

#### REPEAT TRACK

CD

VCD

- To repeat the current track, press **REPEAT**.  
**REPEAT TRACK** appears on the TV screen.
- To repeat the entire disc, press **REPEAT** twice.  
**REPEAT ALL** appears on the TV screen.
- To exit Repeat mode, press **REPEAT** three times.  
**REPEAT OFF** appears on the TV screen.

#### NOTE:

- Repeat playback is not available when you play the Video CD with PBC function.

#### REPEAT A-B

DVD

CD

VCD

- 1 Press **Repeat A-B** at your chosen starting point.
  - **REPEAT A-** appears briefly on the TV screen.
- 2 Press **Repeat A-B** again at your chosen end point.
  - **REPEAT A-B** appears briefly on the TV screen, and the repeat sequence begins.
- 3 To exit the sequence, press **Repeat A-B**.

### Programme

CD

You may determine the order in which tracks will play.

- 1 In stop mode, press **MODE**.
  - The programme screen will appear.

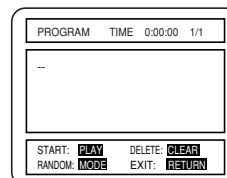

- 2 Enter the desired track numbers using **numerical key pad**.
- 3 Press **PLAY** to play the programmed tracks.

### Random Playback

CD

This shuffles the playing order of tracks instead of playback in the sequence.

- 1 In stop mode, press **MODE** twice.
  - **RANDOM** screen appears.
- 2 Press **PLAY** to start random playback.

**MP3 Playback**

**MP3**

When a CD with MP3 files in the DVD player, the MP3 menu will appear on the TV screen.

- 1** In stop mode, press **▲** or **▼** to select the desired Album or Track.
  - To play a chosen track, press **PLAY** or **ENTER**.
  - To play a chosen album, press **▲** or **▼** to select the desired track, then press **PLAY** or **ENTER**.
  - Choose **FIRST PLAY** to start playback from the beginning of the listed tracks.
  - Press **TITLE** to return to the first item.
- 2** Press **STOP** to stop playback.





**NOTE:**

- Folders are known as Albums; files are known as Tracks.

**On Screen Information**

**MP3**

You can check the MP3 files during playback.

- 1** Press **ON SCREEN**.
  - The playing track will be highlighted.
- 2** Press **ON SCREEN** again to show the elapsed playing time appear at the top of the display.
  -  will be displayed when the repeat play has been selected.
    -  T - indicates Track repeat
    -  A - indicates Album (folder) repeat
    -  D - indicates Disc repeat
- 3** Press **ON SCREEN** again to exit.

**Track Selection**

**MP3**

- 1** Press **DIRECT SKIP** during playback.
  - The **SEARCH** menu will appear.
  - The current track will be highlighted.
- 2** Press **▲** or **▼** to select a desired track.

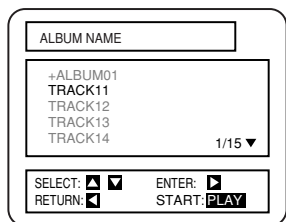

- 3** Press **PLAY** to start playing
- 4** Press **RETURN** or **DIRECT SKIP** to exit.

**Random Playback**

**MP3**

- 1** Press **MODE** twice during playback is stopped.
- 2** Press **PLAY** to play the tracks in random order.

**Programmed**

**MP3**

- 1** Press **MODE** during playback is stopped.
- 2** Press **▲** or **▼** to select a track, then press **ENTER**.
  - Press **CLEAR** to erase the incorrect input.

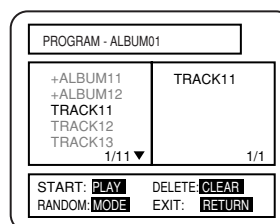

- 3** Press **PLAY** to start programmed playback.

**Audio Language**

**DVD**

The DVD player allows you to select a language during DVD disc (if multi language available) playback.

- 1** Press **AUDIO** during playback.
- 2** Press **AUDIO** repeatedly to select your desired language.

**NOTE:**

- When a DVD disc with MPEG 5.1CH Audio is played back, MPEG 6.0CH might appear instead of MPEG 5.1CH on the screen.

**Stereo Sound Mode**

**CD** **VCD**

- 1** Press **AUDIO** repeatedly during playback to select between **AUDIO STEREO**, **AUDIO L-CH** or **AUDIO R-CH**.

- AUDIO STEREO - both right and left channels are active (stereo)
- AUDIO L-CH - only left channel is active
- AUDIO R-CH - only right channel is active

### Subtitle Language

DVD

The DVD player allows you to select a language for subtitle during DVD disc (if available) playback.

- 1** Press **SUBTITLE** during playback.
- 2** Press **SUBTITLE** repeatedly to select your desired subtitle language.
  - The available languages appears on the right of the subtitle display.
- 3** To turn off subtitles, press ◀ / ▶ or **SUBTITLE** repeatedly until OFF appears.

### Camera Angle

DVD

Some DVD discs contain scenes which have been shot simultaneously from various angles.

- 1** Press **ANGLE** during playback.
- 2** Press **ANGLE** repeatedly to select your desired different angle appears on the right of the angle display.

### Changing the On-Screen Display

DVD

You can check information about the current disc by pressing the ON SCREEN on the remote control.

- 1** Press **ON SCREEN** during playback to show current Chapter.
  - The elapsed and remaining playing time of the current chapter will be displayed.
- 2** Press **ON SCREEN** again to show current Title.
  - The elapsed and remaining playing time of the current title will be displayed.
- 3** Press **ON SCREEN** the third time.
  - The BIT RATE, layer number (if available) and the current repeat setting will be displayed.
- 4** Press **ON SCREEN** the fourth time to remove the display.

CD

VCD

- 1** Press **ON SCREEN** during playback, the current Track will be displayed on the TV screen.
  - The elapsed and remaining playing time of the current track will be displayed.
- 2** Press **ON SCREEN** again to show current Total Track.
  - The elapsed and remaining playing time of the current total track will be displayed.
- 3** Press **ON SCREEN** the third time to remove the display.

### Parental Control

DVD

#### Password

Parental Control limits the disc viewing that exceed your settings with a password or playback will stop.

The 'Parental Control' feature allows you to prevent discs from being played by your children or to have certain discs played with alternative scenes.

- 1** Press **SETUP** during playback is stopped.

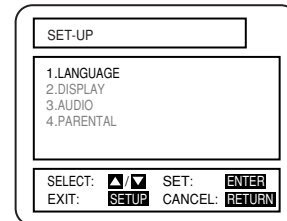

- 2** Press ▲ or ▼ to select PARENTAL, then press **ENTER**.

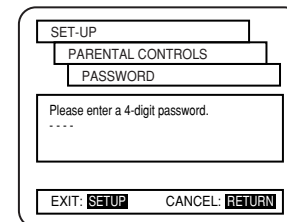

- 3** Enter your four-digit password.
  - If for the first time, enter any four digits, then press **ENTER**.
  - To change the password, press ▲ or ▼ to select **CHANGE**, then press **ENTER**. Enter the four-digit password, then press **ENTER**.
- 4** Press **SETUP** to exit.

#### IF YOU FORGET THE PASSWORD

- 1** Press **SETUP** during playback is stopped.
- 2** Press ▲ or ▼ to select PARENTAL, then press **ENTER**.
- 3** Enter the 4, 7, 3, 7.
  - Password will be cleared and parental level will be set ALL.
- 4** Press **SETUP** to exit.



## Parental Level

DVD

Parental Level allows you to set the rating level of your DVD discs. Playback will stop if the disc's ratings exceed the level you set.

- 1 Press **SETUP** during playback is stopped.
- 2 Press **▲** or **▼** to select PARENTAL, then press **ENTER**.
- 3 Enter your four-digit password.
- 4 Press **▲** or **▼** to select PARENTAL LEVEL, then press **ENTER**.

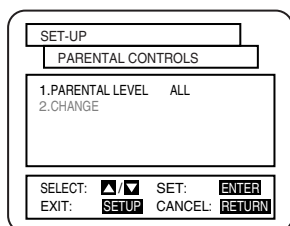

- 5 Press **▲** or **▼** to select the desired level.
- 6 Press **SETUP** to exit.

## Marker Setup Screen

DVD

CD

VCD (without PBC function)

Use markers to memorise your favourite places on a disc.

- 1 Press **DIRECT SKIP** three times during playback.
  - The display screen and Markers will appear on the TV screen.
- 2 Press **◀** or **▶** to select 1, 2, 3, 4 or 5 and ensure that "NOT SET" appears in the display.
- 3 When reaches the desired point, press **ENTER**.
  - The Title or Track and elapsed playing time will appear in the TV screen.
- 4 To return to the Marker later, press **DIRECT SKIP** three times during playback and **◀** or **▶** to choose the desired marker, then press **ENTER**.

### NOTE:

- Opening the disc tray or turning off the power or select AC at step 2 and press **ENTER** will erase all Markers.

## Audio Setting

Choose the appropriate Audio settings for your equipment as it only affect during the playback of DVD discs of the DVD player.

### NOTE:

- These audio settings are effective only when using a digital connection. Although you may change the settings from the on-screen display, these audio settings do not actually affect the sound when using an analogue connection.

- 1 Press **SETUP** during playback is stopped.
- 2 Press **▲** or **▼** to select **AUDIO**, then press **ENTER**.
- 3 Press **▲** or **▼** to choose the below items and press **ENTER** repeatedly to turn the setting ON or OFF.

### Dynamic Range Control (DRC):

- The default setting is OFF.
- To compress the range of sound volume.

### Dolby Digital :

- The default setting is BITSTREAM.  
(BITSTREAM : Output by Dolby Digital)  
(DPCM : Convert the Dolby Digital to D-PCM)  
Set to BITSTREAM when the unit is connected to Dolby Digital Decoder.

### DTS:

- The default setting is OFF.  
Set to ON when the unit is connected to DTS Decoder.  
(ON: Output by DTS)

### MPEG:

- The default setting is OFF.  
(ON : Output by MPEG sound)  
(OFF: Convert the MPEG to PCM)  
Set to ON when the unit is connected to MPEG Decoder.

### DOWN SAMPLING:

- The default setting is AUTO.
  - Press **ENTER**, then **▲** or **▼** to select AUTO, 48kHz or 96kHz. Press **ENTER** again to confirm selection.
  - Select 96kHz if the disc was recorded in PCM 96kHz, otherwise select 48kHz.
- 4 Press **SETUP** to exit.

## Black Level Setting

Adjust the Black Level Settings to make the black parts of the picture as bright as you prefer.

- 1 Press **MODE** during playback.
- 2 Press **ENTER** repeatedly to select ON or OFF.  
ON: makes the dark parts brighter.  
OFF: shows the original picture as recorded.

## Display Setting

You can change certain aspects of the DVD's display screens, on-screen messages and the display panel on the front of the DVD player.

- 1 Press **SETUP** during playback is stopped.
- 2 Press **▲** or **▼** to select **DISPLAY**, then press **ENTER**.
- 3 Press **▲** or **▼** to select the below items, then press **ENTER**.

### TV Aspect:

- Press **▲** or **▼** for an item selection, then press **ENTER**.
- Select 4:3 LETTER BOX for a black bars appears on the top and bottom of the screen.
- Select 4:3 PAN & SCAN for a full height picture with both sides trimmed.
- Select 16:9 WIDE if a wide-screen TV is connected to the DVD player.
- The default setting is 4:3 LETTER BOX.

### Panel Display:

- Press **▲** or **▼** to select BRIGHT, DIMMER and AUTO, then press **ENTER**.
- This adjust the brightness of the display panel with the factory default BRIGHT.
- When AUTO is selected, the display dims only during playback.

### Angle Icon:

- Press **ENTER** repeatedly to turn Angle icon ON or OFF.
- The default setting is ON.

### Auto Power Off:

- Press **ENTER** repeatedly to turn Auto Power ON or OFF.
  - The default setting is ON and it will turn the DVD player to off automatically after 35 minutes of no use.
- 4 Press **SETUP** to exit.

## Language Setting

Language options are not available with some discs.

- 1 Press **SETUP** during playback is stopped.
- 2 Press **▲** or **▼** to select LANGUAGE, then **ENTER** to confirm.
  - The setup screen will be displayed.

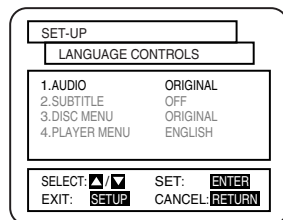

- 3 Press **▲** or **▼** to select AUDIO, SUBTITLE, DISC MENU or PLAYER MENU, then **ENTER** to confirm.
- 4 Press **▲** or **▼** to select a setting, then press **ENTER**.
  - If OTHER is selected in the AUDIO, SUBTITLE or DISC MENU screen, press four-digit number to enter the code for the desired language.
  - Only the languages supported by the disc can be selected.
- 5 Press **SETUP** to exit.

Language	Code	Language	Code	Language	Code	Language	Code
<b>A-B</b>		French [FRE]	5264	Macedonian	5957	Siswat	6565
Abkhazian	4748	Frisian	5271	Malagasy	5953	Slovak	6557
Afar	4747	Galician	5358	Malay	5965	Slovenian	6558
Afrikaans	4752	Georgian	5747	Malayalam	5958	Somali	6561
Albanian	6563	German [GER]	5051	Maltese	5966	Spanish [SPA]	5165
Amharic	4759	Greek [GRE]	5158	Maori	5955	Sundanese	6567
Arabic	4764	Greenlandic	5758	Marathi	5964	Swahili	6569
Armenian	5471	Guarani	5360	Moldavian	5961	Swedish [SWE]	6568
Assamese	4765	Gujarati	5367	Mongolian	5960	<b>T</b>	
Aymara	4771	Hausa	5447	Nauru	6047	Tagalog	6658
Azerbaijani	4772	Hebrew	5569	Nepali	6051	Tajik	6653
Bashkir	4847	Hindi	5455	Norwegian [NOR]	6061	Tamil	6647
Basque	5167	Hungarian [HUN]	5467	<b>O-R</b>		Tatar	6666
Bengali;Bangla	4860	<b>I-K</b>		Occitan	6149	Telugu	6651
Bhutani	5072	Icelandic [ICE]	5565	Oriya	6164	Thai	6654
Bihari	4854	Indonesian	5560	Oromo(Afan)	6159	Tibetan	4861
Bislama	4855	Interlingua	5547	Panjabi	6247	Tigrinya	6655
Breton	4864	Interlingue	5551	Pashto;Pusho	6265	Tonga	6661
Bulgarian	4853	Inupiak	5557	Persian	5247	Tsonga	6665
Burmese	5971	Irish [IRI]	5347	Polish	6258	Turkish [TUR]	6664
Byelorussian	4851	Italian [ITA]	5566	Portuguese [POR]	6266	Turkmen	6657
<b>C-E</b>		Japanese [JPN]	5647	Quechua	6367	Twi	6669
Cambodian	5759	Javanese	5669	Rhaeto-Romance	6459	<b>U-Z</b>	
Catalan	4947	Kannada	5760	Romanian [RUM]	6461	Ukrainian	6757
Chinese [CHI]	7254	Kashmiri	5765	Russian [RUS]	6467	Urdu	6764
Corsican	4961	Kazakh	5757	<b>S</b>		Uzbek	6772
Croatian	5464	Kinyarwanda	6469	Samoan	6559	Vietnamese	6855
Czech	4965	Kirghiz	5771	Sangho	6553	Volapuk	6861
Danish [DAN]	5047	Kirundi	6460	Sanskrit	6547	Welsh	4971
Dutch [DUT]	6058	Korean [KOR]	5761	Scots Gaelic	5350	Wolof	6961
English [ENG]	5160	Kurdish	5767	Serbian	6564	Xhosa	7054
Esperanto	5161	<b>L-N</b>		Serbo-Croatian	6554	Yiddish	5655
Estonian	5166	Laothian	5861	Sesotho	6566	Yoruba	7161
<b>F-H</b>		Latin	5847	Setswana	6660	Zulu	7267
Faroese	5261	Latvian;Lettish	5868	Shona	6560		
Fiji	5256	Lingala	5860	Sindhi	6550		
Finnish [FIN]	5255	Lithuanian	5866	Singhalese	6555		

If you choose a Language that has a 3 letter language code, the code will be displayed everytime you change the Audio or Subtitle language setting on pages 15 and 16. If you choose any other languages, '---' will be displayed instead. (3 letter language code is written in bracket.)

## TROUBLESHOOTING

### WARNING

Under no circumstances should you try to repair the system yourself, as this will invalidate the warranty. Do not open the system as there is a risk of electric shock.

If a fault occurs, first check the points listed below before taking the system for repair.

<b>Problem</b>	<b>Solution</b>
<b>No power</b>	–Check if the AC power cord is properly connected.
<b>No picture</b>	–Check if the TV is switched on. –Check the video connection.
<b>Distorted picture</b>	–Sometimes a small amount of picture distortion may appear. This is not a malfunction.
<b>Completely distorted picture or black/white picture with DVD</b>	–Connect DVD player directly to the TV. –Make sure the disc is compatible with the DVD player.
<b>No sound or distorted sound</b>	–Adjust the volume. –Check that the speakers are connected correctly.
<b>No audio at digital output</b>	–Check the digital connections. –Check if the audio format of the selected audio language matches your receiver capabilities.
<b>No DTS audio at analog output</b>	–Use a DIGITAL AUDIO OUT jack when outputting the DTS audio.
<b>No sound and picture</b>	–Check that the VIDEO/AUDIO cables are connected to the correct device. (See Connecting to a TV)
<b>Picture freezes momentarily during playback</b>	–Check the disc for fingerprints/scratches and clean with a soft cloth wiping from centre to edge.
<b>Disc can't be played</b>	–Ensure the disc label is facing up. –Check if the disc is defective by trying another disc.
<b>No return to start-up screen when disc is removed</b>	–Reset the unit by switching the player off, then on again.
<b>The player does not respond to the remote control</b>	–Aim the remote control directly at the sensor on the front of the player. –Reduce the distance to the player. –Replace the batteries in the remote control. –Re-insert the batteries with their polarities (+/– signs) as indicated.
<b>Buttons do not work or player stops responding</b>	–To completely reset the player, unplug the AC cord from the AC outlet for 5-10 seconds.
<b>Player does not respond to some operating commands during playback.</b>	–Operations may not be permitted by the disc. Refer to the instructions of the disc.
<b>DVD player cannot read CDs/DVDs</b>	–Use a commonly available cleaning CD/DVD to clean the lens before sending the DVD player for repair.

*If you are unable to remedy a problem by following these hints, consult your dealer or service centre.*

## SPECIFICATIONS

### PRODUCT TYPE

DVD Player

### DISCS

DVD video

Audio CD

Video CD

CD-R

CD-RW

### OUTPUT SIGNAL FORMAT

PAL colour

### FREQUENCY RESPONSE

DVD (linear sound) : 20 Hz to 20 kHz (sample rate: 48 kHz)

20 Hz to 44 kHz (sample rate: 96 kHz)

CD : 20 Hz to 20 kHz

### SIGNAL-TO-NOISE RATIO (S/N RATIO)

CD : 110 dB (JEITA)

### DYNAMIC RANGE

DVD (linear sound) : 95 dB

CD : 94 dB (JEITA)

### TOTAL DISTORTION FACTOR

CD : 0.005% (JEITA)

### WOW AND FLUTTER

Below the measurement limitation (+/-0.001% W PEAK)  
(JEITA)

### CONNECTIONS

Video output One RCA connector, 1 Vpp (75 ohm)

Component video output One pin jack (Y), 1 Vpp (75 ohm)  
Two pin jacks Cr/Cb, 700m Vpp  
(75 ohm)

S-Video output Mini DIN 4-pin jack (75 ohm)

Analog audio output Two RCA connectors (one left  
channel, one right channel)  
2 Vrms (47 kilo-ohm)

Coaxial digital audio output One pin jack, 500mVpp (75 ohm)

### POWER SOURCE

110-240 V ~ +/- 10%, 50/60 Hz +/- 0.5%

### POWER CONSUMPTION

14 W (standby: 3.8W)

### OPERATING TEMPERATURE

5°C to 40°C

### DIMENSIONS

W 435mm

H 75mm

D 211mm

### WEIGHT

Approx 2.1kg

- Designs and specifications are subject to change without notice.

## MAINTENANCE

### Cleaning the Cabinet

- Use a soft cloth slightly moistened with a mild detergent solution. Do not use a solution containing alcohol, spirits, ammonia or abrasives.

### Cleaning Discs

- When a disc becomes dirty, clean it with a cleaning cloth. Wipe the disc from the centre out. Do not wipe in a circular motion.
- Do not use solvents such as benzine, thinner, commercially available cleaners, or antistatic spray intended for analogue records.

### Cleaning the disc lens

- After prolonged use, dirt or dust may accumulate at the disc lens. To ensure good playback quality, clean the disc lens with CD Lens Cleaner or any commercially available cleaner. Follow the instructions supplied with the cleaner.

### Make your contribution to the environment!!!

- Spent batteries do not belong in the dustbin.
- You can dispose of them at a collection point for spent batteries or special waste. Contact your council for details.



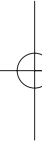
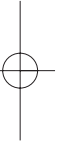

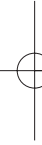

**КОРПОРАЦИЯ ШАРП**  
Осака, Япония