

axxera™

CD Receiver



INSTALLATION/OWNER'S MANUAL

AXD330

MP3

WMA

Works With
PANDORA®

COMPACT
disc
DIGITAL AUDIO

Made for
iPod iPhone

AUX
Front and Rear Inputs

USB

Preparation

Please read entire manual before installation.

Before You Start

- Disconnect negative battery terminal. Consult a qualified technician for instructions.
- Avoid installing the unit where it would be subject to high temperatures, such as from direct sunlight, or where it would be subject to dust, dirt or excessive vibration.

Getting Started

- Remove trim ring from unit.
- Remove 2 transit screws located on top of the unit.
- Insert the supplied keys into the slots as shown, and slide the unit out of the mounting sleeve.
- Install mounting sleeve into opening, bending tabs to secure.
- Connect wiring harness and antenna. Consult a qualified technician if you are unsure.
- Certain vehicles may require an installation kit and/or wiring harness adapter (sold separately).
- Test for correct operation and slide into mounting sleeve to secure.
- Snap trim ring into place.

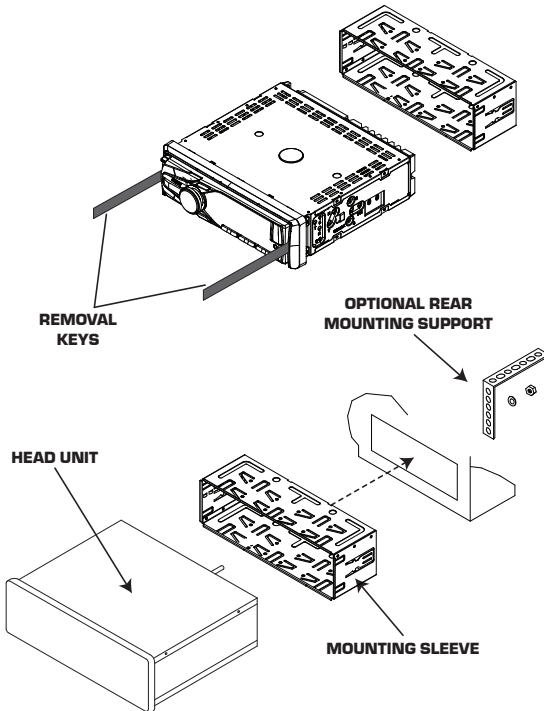

TYPICAL DIN FRONT-LOAD MOUNTING METHOD

AXD330

Wiring Diagram

RCA Preamp Connections

Steering Wheel Interface Input

PAC SW/PS connection (sold separately)

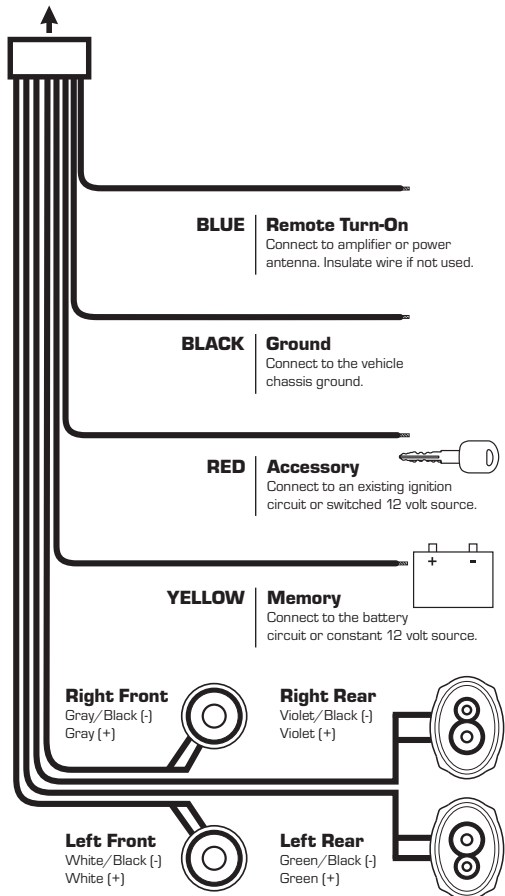
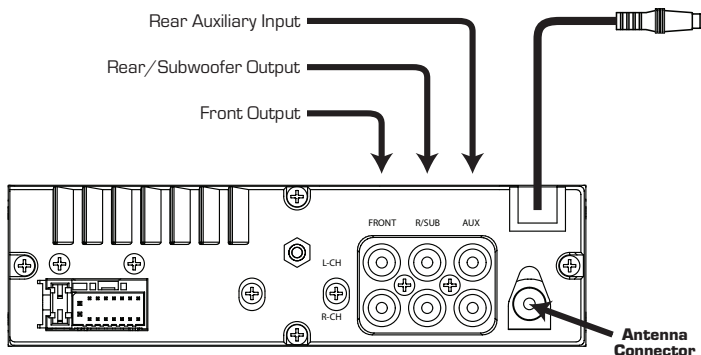

FUSE

When replacing the fuse, make sure new fuse is the correct type and amperage. Using an incorrect fuse could damage the radio. The AXD330 uses one 10 amp ATM fuse located in-line.

Control Locations - Receiver

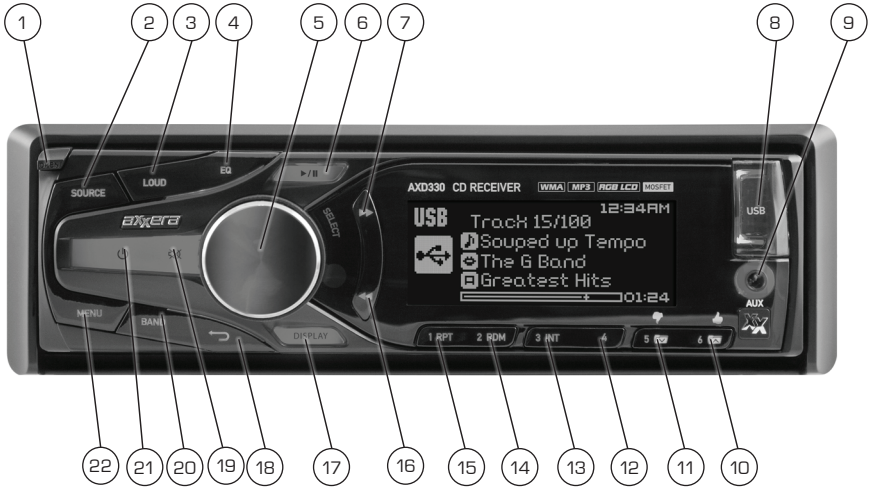

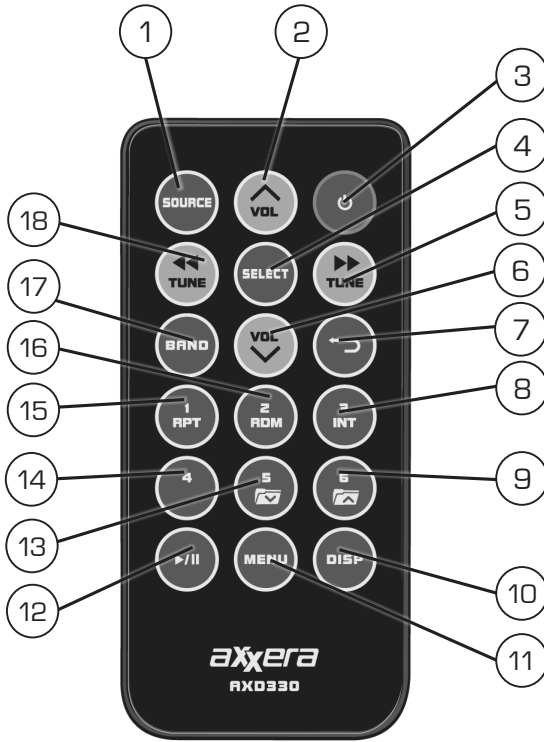

- | | |
|--|---------------------|
| ① Open | ⑫ Preset 4 |
| ② Source | ⑬ Preset 3 / Intro |
| ③ Loudness | ⑭ Preset 2 / Random |
| ④ Equalizer | ⑮ Preset 1 / Repeat |
| ⑤ Volume Knob/ Select (push) | ⑯ Tune / Track Down |
| ⑥ Play / Pause | ⑰ Display |
| ⑦ Tune / Track Up | ⑱ Go Back |
| ⑧ USB Port | ⑲ Mute |
| ⑨ Auxiliary Input | ⑳ Band |
| ⑩ Preset 6 / Folder Up / Thumbs Up | ㉑ Power |
| ⑪ Preset 5 / Folder Down / Thumbs Down | ㉒ Menu |

Control Locations - Remote



- | | |
|---------------------|-----------------------|
| ① Source | ⑩ Display |
| ② Volume Up | ⑪ Menu |
| ③ Power | ⑫ Play / Pause |
| ④ Select | ⑬ Key 5 / Folder Down |
| ⑤ Tune / Track Up | ⑭ Key 4 |
| ⑥ Volume Down | ⑮ Key 1 / Repeat |
| ⑦ Go Back | ⑯ Key 2 / Random |
| ⑧ Key 3 / Intro | ⑰ Band |
| ⑨ Key 6 / Folder Up | ⑱ Tune / Track Down |

General Operation

Faceplate Removal	Press OPEN to open the face plate, then pull away from the right side to remove. To re-install, insert right side of faceplate first then push left side to secure.
Power On/Off	Press  or any other button to turn the unit on. Press  to turn the unit off.
Source	Press SOURCE to enter the Source Menu, then press SOURCE or rotate the volume knob to select between Tuner, Disc, Aux Front, Aux Rear, USB, iPod and Pandora modes. Modes of operation are shown in the display.
Auxiliary Input	The AXD330 offers both front and rear 3.5 mm auxiliary input ports for connecting an audio device, MP3 player, etc. Press SOURCE to select either the front or rear auxiliary input mode.
Volume	Adjust volume using volume knob (00-46).
Display	Press DISP to toggle between ID3 tag and file/folder name for MP3/WMA files being played from CDs or USB devices.
Reset	Press RESET upon initial installation or if abnormal operation occurs. Reset button is located behind the front panel.
Set the Clock	The unit will display the time on the LCD display. Clock settings are adjusted in the General setup menu (refer to page 8).
12/24-hour Clock	The clock will display 12-hour AM/PM time or 24-hour time (22:00). Frequency spacing is adjusted in the General setup menu (refer to page 8).
Changing Illumination Colors	Adjust color of the LCD display by selecting a preset or custom color.
Selecting a Preset Color	Press MENU , and turn the volume knob to "Set Color". Turn the volume knob left/right to cycle between OFF, AUTO or 1-31 preset colors.
Selecting a Custom Color	Press MENU , and turn the volume knob to "Set Color". Choose the level of red from 1-32 using the volume knob , then press SELECT . Repeat for desired levels of green and blue, then press SELECT to confirm the final color.

General Operation

Setup Menu

Press **MENU** to access the setup menu, then turn the **volume knob** to cycle through menu categories: Audio, Color, Display, Tuner, and General.

When desired category appears in the display, press **SELECT**, then rotate the **volume knob** left/right to cycle through the options in each category.

When desired option appears in the display, press **SELECT**, then rotate the **volume knob** left/right to adjust or activate desired function.

Note: Some functions are toggled by pressing **SELECT** and may not require turning the **volume knob**.

Press **ESC** to return to the previous menu or exit the menu while the main menu is displayed.

Audio Setup Menu

Menu Function	Options
Equalization Curves	Rotate the volume knob to cycle through the following equalization curves: Flat, Pop, Jazz, Classic, Beat, Rock and User. Any manual adjustment to the Bass or Treble settings are automatically saved as User.
Bass Level	Rotate the volume knob to adjust the bass level setting (-6 minimum / +6 maximum).
Bass Frequency	Rotate the volume knob to select one of the following bass frequency settings: 60 Hz, 80 Hz, 100 Hz or 200 Hz.
Middle Level	Rotate the volume knob to adjust the middle level setting (-6 minimum / +6 maximum).
Middle Frequency	Rotate the volume knob to select one of the following middle frequency settings: 500 Hz, 1 kHz, 1.5 kHz or 2.5 kHz.
Treble Level	Rotate the volume knob to adjust the treble level setting (-6 minimum / +6 maximum).
Treble Frequency	Rotate the volume knob to select one of the following treble frequency settings: 10 KHz, 12.5 KHz, 15 KHz or 17.5 KHz.
Balance	Rotate the volume knob to adjust the balance setting. (12-L to 12-R; 0 represents equal balance).
Fader	Rotate the volume knob to adjust the fader setting. (12-F to 12-R; 0 represents equal balance)
Subwoofer	Rotate the volume knob to turn subwoofer output ON or OFF.
Subwoofer Level	Rotate the volume knob to adjust subwoofer level between 0 and 12.
Subwoofer Frequency	Rotate the volume knob to select one of the following subwoofer center frequency settings: Off, 80 Hz, 120 Hz and 160 Hz. "Off" represents a full range subwoofer output.

General Operation

General Setup Menu

Menu Function	Options	Action
Tuner Frequency Spacing	USA	Programs the unit to USA tuner spacing. (200kHz for FM and 10kHz for AM).
	S-America	Programs the unit to South American tuner spacing. (100kHz for FM and 10kHz for AM).
	Europe	Programs the unit to European tuner spacing. (50kHz for FM and 9kHz for AM).
Auto Station Store	AUTO STORE	Press SELECT to seek and save 6 strong stations in the current band.
Local/Distance Tuning	Off	Activates distance tuning.
	On	Activates local tuning for strong station reception only.
Set the Clock	Clock	With the unit on, press and hold DISP until the clock begins to flash, then release. Press TUNE ◀◀ to adjust the hours and TUNE ▶▶ to adjust the minutes. Press DISP momentarily to save the selected time.
Clock Mode	12 Hour	Programs the unit to display 12-hour AM/PM time (example: 10:00 PM)
	24 Hour	Programs the unit to display 24-hour time (example: 22:00)
Scrolling Option	Off	Programs the unit to not scroll any information on the display.
	Once	Programs the unit to only scroll information once.
	15Sec	Programs unit to scroll information once every 15 seconds (default).
	On	Programs unit to scroll information continuously.
iPod Control	Full	Programs the head unit to advanced control of the iPod/iPhone device.
	Manual	Programs the head unit to manual control of the iPod/iPhone device and allows music to be controlled from the iPod/iPhone device.
Beep Confirmation	Off	Disables the confirmation beep.
	On	Enables the confirmation beep.
Programmable Turn On Volume	Variable Value	Programs unit to always turn on at a specific volume (default is Off). A volume level of 1-30 can be selected.
Auto Color Change	Auto Off	Programs the unit to remain the selected color.
	Auto On	Programs the unit to constantly change colors.

AXD330

General Operation

Gain Setup Menu

Menu Function	Options
Tuner Gain	Rotate the volume knob to adjust the tuner gain. [-6 minimum / +6 maximum]
Disc Gain	Rotate the volume knob to adjust the gain for disc playback. [-6 minimum / +6 maximum]
Aux Front Gain	Rotate the volume knob to adjust the gain for the front auxiliary input. [-6 minimum / +6 maximum]
Aux Rear Gain	Rotate the volume knob to adjust the gain for the rear auxiliary input. [-6 minimum / +6 maximum]
USB Gain	Rotate the volume knob to adjust the gain for USB playback. [-6 minimum / +6 maximum]
iPod Gain	Rotate the volume knob to adjust the gain for iPod playback. [-6 minimum / +6 maximum]
Pandora Gain	Rotate the volume knob to adjust the gain for Pandora playback. [-6 minimum / +6 maximum]

Color Menu

Menu Function	Options
Auto Change	Sets the unit to rotate between all illumination colors automatically. Setting a preset or user color will cancel the automatic color change.
Set Color	Adjust the color of the button and LCD illumination between 31 preset colors. <ul style="list-style-type: none">• Off: sets the color to white. (default)• Day/Night: sets the color to change to different colors during the day or night. The day and night colors must be set in the Day/Night color menu below.• User: sets the color to the custom color. The custom color must be set in the menu below.• 1-31: choose from any of the 31 preset colors.
Set Custom Color	Individually select the level of Red, Green and Blue from 1 - 32. Any combination of these colors can be selected. Important Note: Setting each Red, Green and Blue levels to 1 will turn off set turn off the illumination for the LCD and buttons.
Set Day/Night Color	Sets individual colors for the day or night. (The clock must be set for proper function). <ul style="list-style-type: none">• Day Color: sets the daytime color to a preset or custom color.• Night Color: sets the nighttime color to a preset or custom color.• Time: adjusts the night time span. Turn the volume knob to adjust. (default is 7pm to 7am)..

AM/FM Tuner Operation

Manual Tuning

Press **TUNE** ◀◀ or **TUNE** ▶▶ momentarily to change radio frequency up or down one step at a time. Press and hold to advance quickly.

Seek Tuning

Press **TUNE** ◀◀ or **TUNE** ▶▶ for more than two seconds (then release) to automatically seek and tune to the next strong station.

Band

Press **BAND** to select between FM1, FM2, FM3, AM1 and AM2 bands.

Storing Station Presets

Select the desired band and station. Press and hold the desired 1-6 preset button for more than two seconds. When stored, the preset number will appear in the display.

Recalling Station Presets

Stored stations can be recalled instantly by pressing the corresponding 1-6 preset button.

CD Operation

Insert CD Press **OPEN** to fold down the front panel and expose the CD slot. With the label facing up, insert a standard size CD into the CD slot. The CD will automatically begin playback.

Eject CD With the front panel open, press **EJECT** to eject the CD. The unit will change to previous mode of operation. If the disc is not removed within 10 seconds, the unit will reload the disc. The unit does not have to be turned on to eject CD.

Track Select Press **TRACK ►►** to skip to the beginning of the next track. Press **TRACK ◄◄** to return to the beginning of the current track. Pressing **TRACK ◄◄** again skips to the beginning of the previous track.

Fast Forward/Reverse Press and hold **TRACK ►►** or **TRACK ◄◄** on the remote control to fast forward or reverse a track.

Pause Press **►/||** to temporarily stop CD playback.
Press **►/||** again to resume playback.

Repeat Press **RPT** to continuously repeat the selected track.

Random Press **RDM** to play all the tracks in random order.

Intro Press **INT** to play the first 10 seconds of each track.

CD-R/CD-RW Compatibility Some CD-Rs and CD-RWs may be incompatible with this unit, depending on media type and recording method. In addition, the following CDs may be incompatible with this unit:

CDs exposed to extreme temperatures or direct sunlight for extended periods of time, CDs recorded in which a recording session failed or a re-recording was attempted and, or encrypted or copy-protected CDs which do not conform to the audio CD-DA red book recording standard.

MP3/WMA Operation

Playing MP3/WMA Files

To play MP3/WMA files, insert a data CD or USB device containing MP3/WMA files. "Loading" will flash in the display. Depending on the number of files and folders, this may take several seconds.

Displaying Information

Press **DISP** to cycle between track information and file/folder information.

*Song title, artist name and album name will only be displayed if included with the MP3/WMA file.

When referring to MP3/WMA playback, the following terms are synonymous:

- File name and track name
- Folder name and directory name

Repeat

Press **RPT** to enter the Function Menu, then rotate the **volume knob** until Repeat is highlighted. Press **SELECT**, then rotate the **volume knob** to select one of the following repeat options.

- All - Plays all songs on disc or device.
- Track - Continuously repeats selected song.
- Folder - Continuously repeats all songs in selected folder.

Random

Press **RDM** to enter the Function Menu, then rotate the **volume knob** until Random is highlighted. Press **SELECT**, then rotate the **volume knob** to select one of the following options for random playback.

- Off - Cancels the Random function.
- All - Plays all songs in random order.
- Folder - Plays all songs in folder in random order.

Intro

Press **INT** to enter the Function Menu, then rotate the **volume knob** until Intro is highlighted. Press **SELECT**, then rotate the **volume knob** to select one of the following options for intro playback.

- Off - Cancels the Intro function.
- All - Plays first 10 seconds of each song.
- Folder - Plays first 10 seconds of each song in folder.

Note: Folder repeat, random and intro options only function on MP3/WMA discs or devices recorded with more than one folder.

MP3/WMA Operation

File/Folder Search

- Begin Searching** Press **SELECT** to enter the file/folder search mode. A list of all the folders from the disc or device will be displayed.
- Note:** Any files located in the root directory will be located in the folder named "ROOT".
- Choose a Song** Turn the **volume knob** to cycle through all the folders on the disc or device, and press **SELECT** to choose the desired folder. The list of files in the selected folder will be displayed. Turn the **volume knob** to cycle through the list of files.
- Menu Navigation** Pressing **GO BACK** when viewing the contents of a folder will return to the list of folders on the disc or device. Press **GO BACK** again to exit the search menu.
- Playing a Song** Once the desired song is displayed, press **SELECT** to begin playback of the desired song.

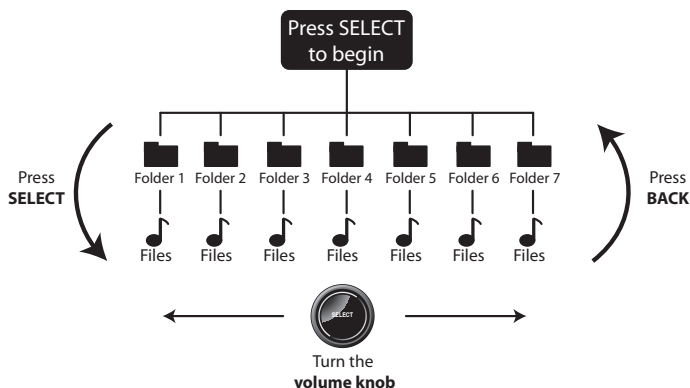

MP3/WMA Operation

File/Folder Compatibility and Support - CD

Type	Specification
Compatible File Types	<ul style="list-style-type: none"> • CD-ROM (ISO), CD-R, CD-RW • CD-DA (digital audio) • MP3 data [.mp3] • WMA data [.wma]
Incompatible File Types	<ul style="list-style-type: none"> • DRM protected files • WMA lossless • Apple lossless • WMA Pro • MP3 Pro • MP3 playlists • WAV lossless • M4A/AAC data
Recording Format Compatibility	<ul style="list-style-type: none"> • ISO9660 level 1 & level 2 • Yellow book MODE 1 & MODE 2 FORM 1 • Multi session
Sampling Frequency Rate Compatibility	<ul style="list-style-type: none"> • MP3: 8kHz - 48kHz • WMA: 32kHz - 48kHz
Transfer Bit Rate Compatibility	<ul style="list-style-type: none"> • MP3: 32kbps - 320kbps • WMA: 32kbps - 192kbps
Character Support	<ul style="list-style-type: none"> • Song Title: 32 characters • Artist Name: 32 characters • Album Name: 32 characters • File Name: 32 characters • Folder Name: 32 characters
ID3 Tag Support	<ul style="list-style-type: none"> • MP3 Tags: Version 1.0 - 2.4 • WMA Tags
File/Folder Limit	<ul style="list-style-type: none"> • Maximum files: 999 • Maximum folders: 500 • Maximum folder levels: 8

MP3/WMA Operation

File/Folder Compatibility and Support - USB

Type	Specification
Compatible File Types	<ul style="list-style-type: none"> • MP3 data (.mp3) • WMA data (.wma)
Incompatible File Types	<ul style="list-style-type: none"> • DRM protected files • WMA lossless • Apple lossless • WMA Pro • MP3 Pro • MP3 playlists • M4A/AAC data • WAV lossless
Sampling Frequency Rate Compatibility	<ul style="list-style-type: none"> • MP3: 8kHz - 48kHz • WMA: 32kHz - 48kHz
Transfer Bit Rate Compatibility	<ul style="list-style-type: none"> • MP3: 32kbps - 320kbps • WMA: 32kbps - 192kbps
Character Support	<ul style="list-style-type: none"> • Song Title: 32 characters • Artist Name: 32 characters • Album Name: 32 characters • File Name: 32 characters • Folder Name: 32 characters
ID3 Tag Support	<ul style="list-style-type: none"> • MP3 Tags: Version 1.0 - 2.4 • WMA Tags
File/Folder Limit	<ul style="list-style-type: none"> • Maximum number of files: 50000 • Maximum number of folders: 500 (plus the root folder) • Maximum number of files in each folder: 50000 <p>Note: For devices with more than the maximum number of files/folders, some files will be ignored and may not function properly.</p>
USB File System	<ul style="list-style-type: none"> • FAT/FAT32 file system supported. • HFS/NTFS/EXT2/EXT3 not supported.

iPod Operation

Connect an iPod Device (Not Included)



The AXD330 features a direct USB control system for iPod. To play music from an iPod device, connect the USB cable (included with your iPod device) to the USB port on the front panel.

Once connected, "Loading" will flash in the display, then playback will begin automatically. If a song is playing on the iPod device before it is connected, it will continue to play.

Search Mode

Search Menu Functions (step 1)

Press **SELECT** once to enter the search mode.

(step 2)

Rotate the **volume knob** to choose between **playlist**, **songs**, **artists**, **albums** and **podcasts**. Press **SELECT** to select the desired search type.

(step 3)

Navigate to the desired song and press **SELECT** to begin playback of that song. Use the table below for reference when navigating through the menu options.

Note: Press **GO BACK** to access the previous level (up one level). Pressing **GO BACK** from the search main menu will exit the search.

See the below table for a list of the search menu navigation options.

Search Item	Menu Navigation
Playlist	Menu → Playlists → Songs
Songs	Menu → Songs
Artists	Menu → Artists → Albums → Songs
Albums	Menu → Albums → Songs
Podcase	Menu → Podcasts

Full/Manual Control

The AXD330 features both full and manual control modes for iPod/iPhone devices. See page 8 for details to toggle the control between full and manual modes.

Important: To support manual control for iPod/iPhone, the iPod device must be updated to the newest firmware.

Note: Not all iPod/iPhone devices are compatible with manual control mode.

iPod Operation

Song Select	Press ►► to skip to the beginning of next song. Press ◀◀ to return to the beginning of current song. Pressing ◀◀ again skips to the beginning of previous song.
Fast Forward and Reverse	Press and hold ►► or ◀◀ to fast forward or reverse a song.
Pause	Press ►/ to temporarily stop playback. Press ►/ again to resume playback.
Repeat	Press RPT to enter the Repeat menu, then turn the volume knob to select one of the following options: <ul style="list-style-type: none">• Off - Repeats all tracks.• Current Song - Repeats selected track.
Random	Press RDM to enter the Random menu, then turn the volume knob to select one of the following options: <ul style="list-style-type: none">• Off - Cancels the RDM function.• All Songs - Plays all tracks in random order.• Current Album - Plays all tracks in the selected album in random order.
Intro	Press INT to enter the Intro menu, then turn the volume knob to select one of the following options: <ul style="list-style-type: none">• Off - Cancels the INT function.• On - Plays first 10 seconds of each track.
Character Support	<p>Only alphanumeric characters can be displayed (ASCII type). "NO SUPPORT" will be displayed if the file contains characters that can not be displayed. "NO FILE" will be displayed if there are no songs in the selected playlist.</p> <p>Maximum character display information</p> <ul style="list-style-type: none">• *Song title - 32 character maximum• *Artist name - 32 character maximum• *Album name - 32 character maximum <p>*Song Title, Artist Name and Album name will only be displayed if included with the file.</p>

Pandora Operation

Requirements	Control for Pandora requires: <ul style="list-style-type: none">• An iPhone device with a reliable data connection, or an iPod touch that is connected to wireless internet.• The Pandora App installed on the iPhone/iPod device.• An active account with Pandora. Sign up at www.pandora.com.• The USB sync cable that came with your iPod/iPhone device.
USB Connection	Connect an iPod touch or iPhone device (required, sold separately) to the USB port, using the USB sync cable included with your iPhone device.
Changing Stations	<ol style="list-style-type: none">1. Press SELECT to display the Stations Menu.2. Rotate the volume knob to choose to sort channels by date or alphabetically.3. Press SELECT to confirm, then turn the volume knob to cycle through the list of stations.4. Press SELECT when the desired station is highlighted, and playback will begin. <p>Note: Stations must be created on your account prior to connecting your iPod/iPhone device to the head unit.</p>
Shuffle	Press SELECT to display the Stations Menu. Choose "Shuffle" from the stations menu to shuffle songs from all of your stations.
Skipping Tracks	Press ▶▶ to skip the current song.
Play/Pause	Press ▶/ to temporarily stop playback. Press ▶/ again to resume playback.
Thumbs Up	Press 👍 to tell Pandora you like the current track. Pandora will play more tracks with similar qualities.
Thumbs Down	Press 👎 to tell Pandora you do not like the current track. Pandora will not play the current track again, and will avoid playing tracks with similar qualities.
Device Compatibility	Refer to www.pandora.com/everwhere/mobile for devices compatible with the Pandora mobile application.
Troubleshooting	<p>Note: Pandora is an internet service, carrier and data charges may apply.</p>

AXD330

Notes

Limited One-Year Warranty

This warranty gives you specific legal rights. You may also have other rights which vary from state to state.

Dual Electronics Corp. warrants this product to the original purchaser to be free from defects in material and workmanship for a period of one year from the date of the original purchase.

Dual Electronics Corp. agrees, at our option, during the warranty period, to repair any defect in material or workmanship or to furnish an equal new, renewed or comparable product (whichever is deemed necessary) in exchange without charges, subject to verification of the defect or malfunction and proof of the date of purchase. Subsequent replacement products are warranted for the balance of the original warranty period.

Who is covered? This warranty is extended to the original retail purchaser for products purchased from an authorized Dual dealer and used in the U.S.A.

What is covered? This warranty covers all defects in material and workmanship in this product. The following are not covered: software, installation/removal costs, damage resulting from accident, misuse, abuse, neglect, product modification, improper installation, incorrect line voltage, unauthorized repair or failure to follow instructions supplied with the product, or damage occurring during return shipment of the product. Specific license conditions and copyright notices for the software can be found via www.dualav.com.

What to do?

1. Before you call for service, check the troubleshooting guide in your owner's manual. A slight adjustment of any custom controls may save you a service call.
2. If you require service during the warranty period, you must carefully pack the product (preferably in the original package) and ship it by prepaid transportation with a copy of the original receipt from the retailer to an authorized service center.
3. Please describe your problem in writing and include your name, a return UPS shipping address (P.O. Box not acceptable), and a daytime phone number with your shipment.
4. For more information and for the location of the nearest authorized service center please contact us by one of the following methods:

- Call us toll-free at 1-866-382-5476
- E-mail us at cs@dualav.com

Exclusion of Certain Damages: This warranty is exclusive and in lieu of any and all other warranties, expressed or implied, including without limitation the implied warranties of merchantability and fitness for a particular purpose and any obligation, liability, right, claim or remedy in contract or tort, whether or not arising from the company's negligence, actual or imputed. No person or representative is authorized to assume for the company any other liability in connection with the sale of this product. In no event shall the company be liable for indirect, incidental or consequential damages.

Troubleshooting

Problem	Cause	Action
Unit will not turn on (no power)	Yellow wire not connected or incorrect voltage Red wire not connected or incorrect voltage	Check connections for proper voltage (11-16VDC)
	Black wire not connected	Check connection to ground
	Fuse blown	Replace fuse
Unit has power (but no sound)	Speaker wires not connected	Check connections at speakers
	One or more speaker wires touching each other or touching chassis ground	Insulate all bare speaker wires from each other and chassis ground
Unit blows fuses	Yellow or red wire touching chassis ground	Check for pinched wire
	Speaker wires touching chassis ground	Check for pinched wire
	Incorrect fuse rating	Use fuse with correct rating
Excessive skipping	Unit is not mounted correctly or backstrap is not secure	Check mounting sleeve and backstrap support
	Physical defect in media (CD, CD-R or CD-RW)	Check media for scratches
NO FILE appears on display	Disc read error	Press eject or RESET
	Focus error or disc is upside down	Press eject or RESET
	WMA file is protected by DRM (Digital Rights Management)	Write disc using WMA files that are not protected
	No playable MP3/WMA files found on the device	Check the device for valid MP3/WMA files
	Communication error	Remove and reconnect the device
Unit will not accept a disc	CD mechanism position out of alignment	Press EJECT to reset CD mechanism position
	CD transit screws still in place	Remove 2 transit screws located on top of the unit
NO SUPPORT appears on display	An invalid ID3 tag version is present	Version 1.0 to 2.4 ID3 tags are supported.

AXD330

Specifications

CD Player	Frequency response: 20Hz-20kHz Channel separation @ 1kHz: >65dB D/A converter: 1 Bit
FM Tuner	Tuning range: 87.5MHz-107.9MHz Usable sensitivity: 8.5dBf 50dB quieting sensitivity: 10dBf Stereo separation @ 1kHz: >30dB Frequency response: 30Hz-13kHz
AM Tuner	Tuning range: 530kHz-1710kHz Usable sensitivity: 22uV Frequency response: 30Hz-2.2kHz
General	Speaker output impedance: 4-8 ohms Line output voltage: 4 Volts RMS Dimensions: 7" x 7" x 2" (178 x 178 x 50 mm)

Design and specifications subject to change without notice.



CEA-2006 Power Standard Specifications (reference: 14.4VDC +/- 0.2V, 20Hz-20kHz)

Power Output: 18 Watts RMS x 4 channels at 4 ohms and \leq 1% THD+N
Signal to Noise Ratio: 70dBA (reference: 1 watt into 4 ohms)

FCC Compliance

This device complies with Part 15 of the FCC Rules. Operation is subject to the following two conditions:

(1) this device may not cause harmful interference, and

(2) this device must accept any interference received, including interference that may cause undesired operation.

Warning: Changes or modifications to this unit not expressly approved by the party responsible for compliance could void the user's authority to operate the equipment.

Note: This equipment has been tested and found to comply with the limits for a Class B digital device, pursuant to Part 15 of the FCC Rules. These limits are designed to provide reasonable protection against harmful interference in a residential installation. This equipment generates, uses and can radiate radio frequency energy and, if not installed and used in accordance with the instructions, may cause harmful interference to radio communications. However, there is no guarantee that interference will not occur in a particular installation. If this equipment does cause harmful interference to radio or television reception, which can be determined by turning the equipment off and on, the user is encouraged to try to correct the interference by one or more of the following measures:

- Reorient or relocate the receiving antenna.
- Increase the separation between the equipment and receiver.
- Connect the equipment into an outlet on a circuit different from that to which the receiver is connected.
- Consult the dealer or an experienced radio/TV technician for help.



Dual Electronics Corp.
Toll Free: 1-866-382-5476
Monday-Friday, 9AM-5PM, EST

www.axxeraaudio.com
©2013 Dual Electronics Corp. All rights reserved.

iPhone, iPod, iPod classic, iPod nano, and iPod touch are trademarks of Apple Inc., registered in the U.S. and other countries.

"Made for iPod" and "Made for iPhone" mean that an electronic accessory has been designed to connect specifically to iPod or iPhone, respectively, and has been certified by the developer to meet Apple performance standards. Apple is not responsible for the operation of this device or its compliance with safety and regulatory standards. Please note that the use of this accessory with iPod or iPhone may affect wireless performance.

Pandora, the Pandora logo, and the Pandora trade dress are trademarks of Pandora Media, Inc., used with permission.

Other trademarks and trade names are those of their respective owners.

NSA0613-V01