

User Manual



VB0038

Ventilation Systems

vänEE CANADIAN MODEL NUMBERS

1001 ERV*



1001 HRV*



2001 ERV

2001 HRV*



BROAN U.S.A. MODEL NUMBERS

HRV100H

HRV200H

ERV100HC

ERV200HC

* These products earned the ENERGY STAR® by meeting strict energy efficiency guidelines set by Natural Resources Canada and the US EPA. They meet ENERGY STAR requirements only when used in Canada.

Address of your installer

To register your Broan product on line visit: www.broan.com/register

03118 rev. D

ABOUT THIS MANUAL/PRODUCT

The purpose of this manual is to help you with the use of your unit. Section 2 (How to Operate the Unit Using Controls) shows you how you can operate the unit in no time. Section 3 deals with maintenance and explains how to maintain the unit to ensure maximum operation and performance. In the other sections, for example Troubleshooting, you will learn how to solve minor problems (Section 4); plus other important information which we urge you to read.

Several models are described in this publication. Some details of your unit may be slightly different than the ones shown, as the illustrations are typical ones.

We welcome any suggestions you may have concerning this manual and/or the unit, and we would appreciate hearing your comments on ways to better serve you. Please forward all correspondence to us at the address indicated on the warranty text included with this manual.

This manual uses the following symbols to emphasize particular information:

WARNING

Identifies an instruction which, if not followed, might cause serious personal injuries including possibility of death.

CAUTION

Denotes an instruction which, if not followed, may severely damage the unit and/or its components.

NOTE: Indicates supplementary information needed to fully complete an instruction.

Finally, we want to congratulate you on your purchase of this excellent unit which will allow you and your family to enjoy fresh air throughout your home for years to come!

CAUTION

Some activities create dust or vapors which may damage your unit. You must therefore turn off and unplug your unit in the following situations:

- major renovation work
- housing construction
- sanding (e.g. gypsum joints, etc.)
- varnishing

During very heavy snowstorms, the unit should also be turned off to avoid problems caused by snow entering the unit, even if the installation is equipped with an anti-gust intake hood.

TABLE OF CONTENTS

1.YOUR UNIT AND ITS PURPOSE	4-6
1.1 Unit Description.....	4
1.2 Purpose of the Ventilation System.....	4
1.3 Recovery.....	5
1.4 Defrosting.....	6
1.5 Specifications.....	6
2.HOW TO OPERATE THE UNIT USING CONTROLS.....	7-16
2.1 Instructions Regarding your Control Devices	7-8
2.2 Using the Platinum Main Control	9
2.3 Using the Basic/VT1W Main Control	12
2.4 Using the VT2W Main Control	13-14
2.5 Using the Humidity Main Control	15
2.6 Using the 3-Position Switch	15
2.7 Using the Optional Controls.....	16
3.MAINTENANCE.....	17-19
3.1 Every Three Months	17-18
3.2 Annual Maintenance (Fall).....	18-19
4.TROUBLESHOOTING	20

1. YOUR UNIT AND ITS PURPOSE

1.1 UNIT DESCRIPTION

1. Power supply cord
2. Filters
3. Recovery core
4. Condensation tray
5. Blower assembly

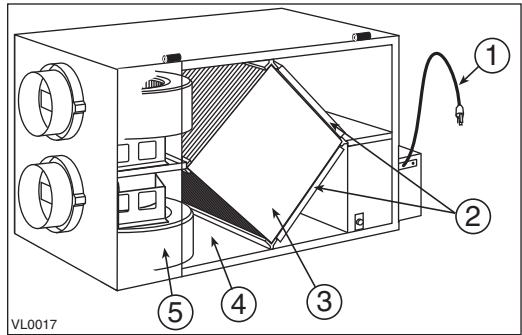

1.2 PURPOSE OF THE VENTILATION SYSTEM

Your ventilation system is designed to provide fresh air, warmed outdoor air to your home while exhausting stale, humid air from your home. By eliminating accumulated pollutants and humidity, it maintains an optimum air quality and an ideal relative humidity.

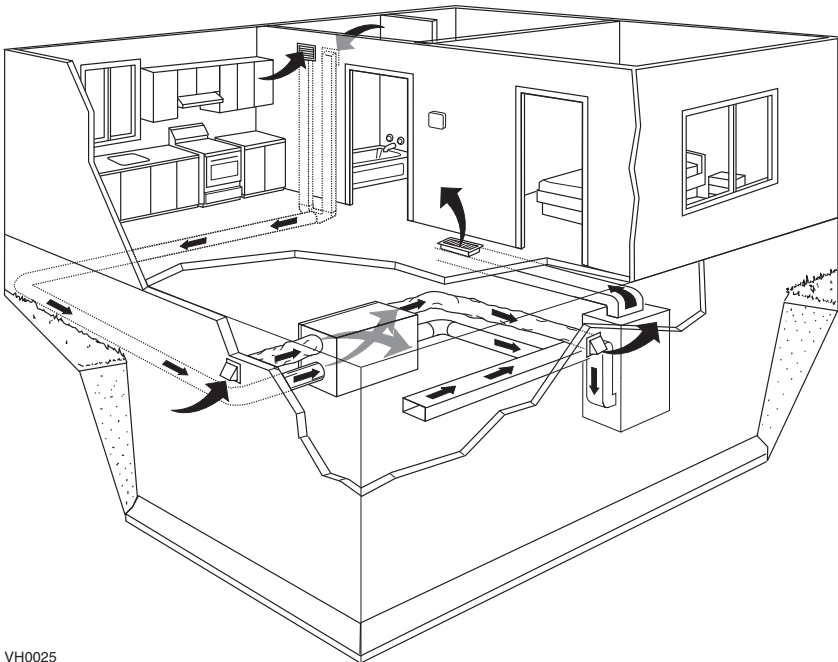

VH0025

- NOTES: 1. Shown with a forced air system. Can also operate on its own.
2. Installation may vary.

1.3 RECOVERY

- Units equipped with a heat recovery core (polypropylene core) are specifically designed to control excess humidity and reduce ventilation costs by recovering the heat energy from the exhausted air, and using that same heat energy to warm the fresh air being supplied. This heat recovery process is accomplished in such a way that the stale air is never mixed with the fresh air.

Example (in winter):



- Units equipped with a heat and humidity recovery core (enthalpic core) can reduce ventilation costs in winter as well as in summer.
- During the heating season, the unit draws the humidity and heat from the stale air and transfers them, in part, to the cold air entering the house, thus avoiding dryness problems and providing maximum comfort.

Example (in winter):

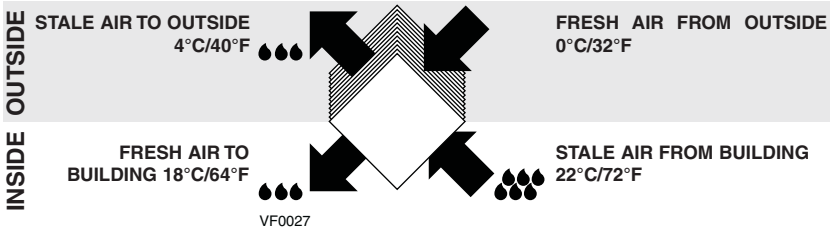

- During the cooling season, the unit reverses the process, preventing the humidity from the outside air from entering into the house.

Example (in summer with air conditioning):

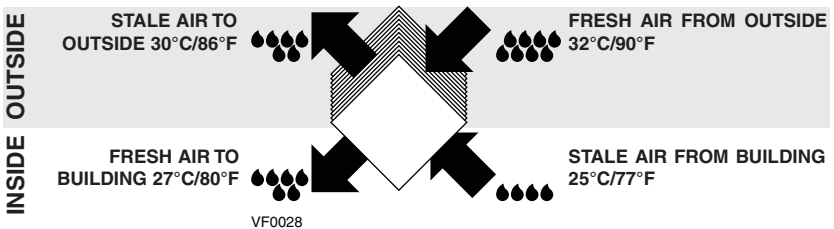

1.4 DEFROSTING

When the outside temperature is below 0°C (32°F), recovery (of heat or energy) creates frost in the core. To maintain its proper operation, the unit is programmed to defrost the recovery core. The defrost frequency varies according to the outside temperature. Defrosting lasts 6 minutes. During the defrost cycle, the unit shifts to maximum speed and the dampers close.

After defrosting, the unit returns to the operating mode selected by the user.

1.5 SPECIFICATIONS

Model	1001 ERV, 1001 HRV, HRV100H, ERV100HC
Width	30¼" (768 mm)
Height	20" (508 mm)
Depth	13¾" (349 mm)
Weight	65 lb (30 kg)
Electrical Supply	120 V, 60 Hz
Power Consumption	150 Watts

Model	2001 ERV, 2001 HRV, HRV200H, ERV200HC
Width	30¼" (768 mm)
Height	20" (508 mm)
Depth	19" (483 mm)
Weight	73 lb (33 kg)
Electrical Supply	120 V, 60 Hz
Power Consumption	225 Watts

2. HOW TO OPERATE THE UNIT USING CONTROLS

2.1 INSTRUCTIONS REGARDING YOUR CONTROL DEVICES

Refer below and on the following page to identify which controls are installed in your house. Then, go to the pages indicated to learn how to CONTROL your unit.

MAIN CONTROLS

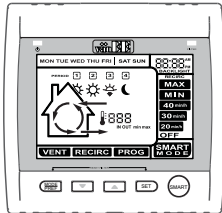

VCO104

PlatinumPage 9

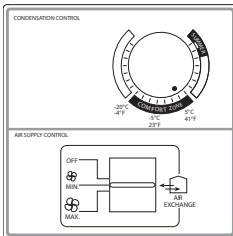

VCO027

Basic/VT1WPage 12

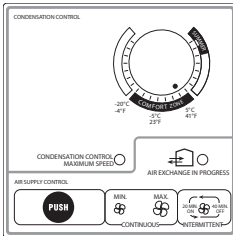

VCO028

VT2WPage 13

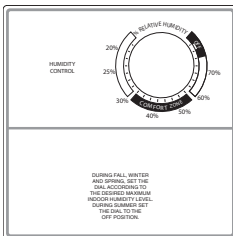

VCO071

Humidity ControlPage 15

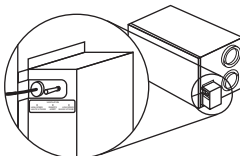

VCO072

3-Position SwitchPage 15

2.1 INSTRUCTIONS REGARDING YOUR CONTROL DEVICES (CONT'D)

OPTIONAL CONTROLS

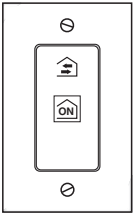

VC0030

20-minute push-button timerPage 16

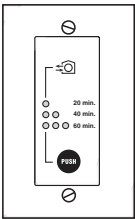

VC0046

20/40/60-minute push-button timerPage 16

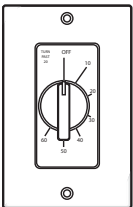

VC0017

60-minute crank timerPage 16

2.2 USING THE PLATINUM MAIN CONTROL

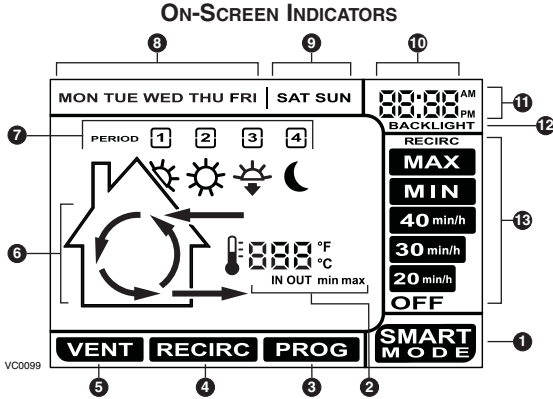

- 1 **SMART Mode.** Entirely automatic mode optimizing the ventilation.
- 2 **Temperature Indicators.**
- 3 **Program Mode.** Allows to program the desired ventilation according to the period of the day.
- 4 **Recirculation Mode.** Manual mode performing air recirculation inside the house.
- 5 **Ventilation Mode.** Manual mode performing air exchange with the outside.
- 6 Animated Arrows showing ventilation status (recirculation or air exchange).
- 7 Periods of the day (morning, day, evening and night).
- 8 Week days.
- 9 Week-end days.
- 10 Hour display.
- 11 AM or PM display.
- 12 Appears only when setting backlight preferences.
- 13 Ventilation / Recirculation speeds and programming options.

CASING INDICATORS AND KEYS

- A **SMART key:** Enables and disables the **SMART** mode.
- B **Set key:**
 - Press 3 seconds to access setting periods for Program mode.
 - Confirms the chosen option and goes to following setting.
- C **Arrow keys:**
 - Adjust ventilation and recirculation speeds.
 - Allows to review the program's period.
 - Adjust Preference and Program values.
- D **Mode / Pref key:**
 - Mode: Selects whether **Ventilation, Recirculation** or **Program** mode.
 - Pref: Push 3 seconds to access Preference settings.
- E **Reset filter keys:** Press on **B** and **D** keys simultaneously for 5 seconds to turn off (reset) the filter maintenance indicator.

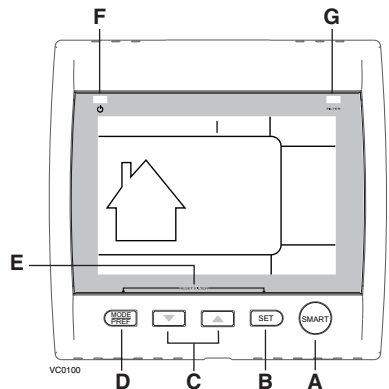

- F **Power indicator:** Illuminates when the control is operating.
- G **Filter maintenance indicator:** Perform filters maintenance. (Refer to Section 3 Maintenance).

2.2 USING THE PLATINUM MAIN CONTROL (CONT'D)

The Platinum main control is pre-programmed and ready to go. All you have to do is to set day and time. Then check the settings below and change if needed.

SETTING PREFERENCES

Press on **MODE / PREF** key (**D**) for 3 seconds.

NOTE: You can exit Preferences setting by pressing on **MODE / PREF** key (**D**) for 3 seconds any time in the process, or wait 60 seconds. The modified values will be kept in memory.

WHAT WILL YOU SEE

If the control will be set for the very first time, the current day will be the first setting to be made; **MON** (for Monday) will flash on screen.

If the control was previously set up, when setting preferences, the control returns to the last preference chosen on previous setting. While setting Preferences, the corresponding setting value flashes (e.g.: while setting current hour, hour is flashing).

HOW TO PROCEED

For every settings in table below:

- Use to select value.
- Press **SET** key (**B**) to confirm the selected preference and go to next setting.

SETTING	AVAILABLE VALUE	DEFAULT OPTIONS
CURRENT DAY	MON/TUE/WED/THU/FRI/SAT/SUN	MON
HOUR DISPLAY	12:00 ^{AM} OR 24:00	12:00 ^{AM}
CURRENT HOUR	FROM 0 TO 12 OR 24	12
CURRENT MINUTE	FROM 00 TO 59	00
TEMPERATURE UNIT	°C OR °F	°C
INSIDE TEMPERATURE DISPLAY	ON OR OFF	ON
MINIMUM OUTSIDE TEMPERATURE FOR AIR EXCHANGE*	-40°C TO 0°C OR -40°F TO 32°F	-25°C OR -13°F
MAXIMUM OUTSIDE TEMPERATURE FOR AIR EXCHANGE*	1°C TO 40°C OR 33°F TO 104°F	27°C OR 81°F
*IN PROG OR SMART MODE, THESE LIMIT VALUES ALLOW TO STOP AIR EXCHANGE WITH THE OUTSIDE.		
BACKLIGHT COLOR	BLUE OR GREEN	BLUE
BACKLIGHT DISPLAY	AUTO OR ON	AUTO
AUTO: BACKLIGHT ACTIVATED 10 SECONDS WHEN ANY KEY IS PRESSED. ON: BACKLIGHT ALWAYS ON.		
OFF MODE FOR INTERMITTENT MODE	VENTILATION/RECIRCULATION OR VENTILATION/OFF	VENT/RECIRC.
AFTER A VENTILATION PERIOD, DETERMINES THE SECOND PART OF THE CYCLE (RECIRCULATION OR OFF).		

2.2 USING THE PLATINUM MAIN CONTROL (CONT'D)

Pressing on **MODE / PREF** key (**D**) successively allows to go from **Ventilation** mode to **Recirculation** mode and then to **Program** mode (**VENT 5** , **RECIRC 4** and **PROG 3** on control screen).

- In **Ventilation** Mode, use to change the ventilation speed (displayed in **6** in all options except **RECIRC**).
- In **Recirculation** mode, use to change the recirculation speed (displayed in **6**, OFF, MIN, MAX).
- In **Program** mode, use to review the period settings without changing them (the period icons are displayed in **7**).

Pressing once on **A** allows to turn the ventilation unit in Smart mode. On this mode, the ventilation unit operation will be driven by the outdoor temperature and by the indoor conditions. Press once more to exit Smart mode.

SETTING PERIODS FOR PROGRAM MODE

The Program Mode allows the user to customize the operation of his/her ventilation unit, for week and weekend days. All days are divided in 4 periods. The periods starting hour and ventilation speed are factory set (see below).

DAILY PERIODS DEFAULT SETTINGS		
PERIOD	STARTING HOUR	MODE
PERIOD 1 (MORNING)	6:00 AM	MIN
PERIOD 2 (DAY)	9:00 AM	20 MIN/H
PERIOD 3 (EVENING)	5:00 PM	MIN
PERIOD 4 (NIGHT)	11:00 PM	20 MIN/H

To change these values:

Press on **SET** key (**B**) for 3 seconds, **PROG** (for program) will appear on screen, and week days will flash.

NOTE: You can exit Periods setting by pressing on **SET** key (**B**) for 3 seconds any time in the process, or wait 60 seconds.

- Use to select between setting week days or weekend days.
- Press **SET** key (**B**) to confirm the choice, and go to setting daily Period 1. (**Period 1** will appear on screen, and hour display will flash.)

- Use to select the period starting hour.

NOTE: Time changes by 15 minutes increments.

- Press **SET** key (**B**) to confirm and go to select the ventilation speed or type (will flash on screen).
- Use to select the ventilation speed or type.
- Press **SET** key (**B**) to confirm and go to daily Period 2. (**Period 2** will appear on screen, and hour display will flash.)

Proceed as for Period 1 for all daily periods. Once the ventilation speed or type for daily Period 4 has been selected:

- Press **SET** key (**B**) to confirm.

NOTE : If the week days were the first to be set, the weekend days will appear on screen; but if the weekend days were the first to be set, then the week days will appear on screen.

(**Period 1** will appear on screen, and hour display will flash.)

- Set periods as described above.

2.3 USING THE BASIC/VT1W MAIN CONTROL

Location: Located in the busiest area of the house.

Purpose: To adjust air supply and reduce condensation on windows.

ADJUSTING THE AIR SUPPLY CONTROL

a) **Select** speed “MIN.” or “MAX.” using switch **A** (as shown on diagram).

- When “MIN.” (minimum speed) is selected, if the knob **B** is set above the click, the unit will exchange in low speed with the outside and if it is set below the click, the unit will exchange on high speed with the outside until the desired humidity level has been reached.
- When “MAX.” (maximum speed) is selected, the unit will exchange on high speed with the outside either if the knob **B** is set below or above the click.

b) To **turn the unit off**, slide selector **A** at the “OFF” position.

Optional controls, however, may still be active.

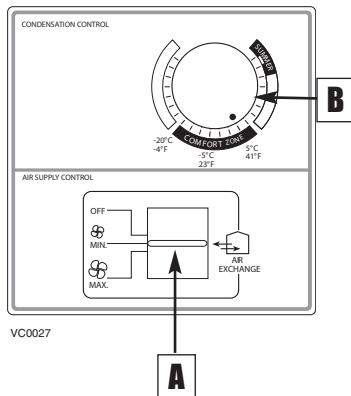

ADJUSTING THE CONDENSATION CONTROL

Setting during the summer months:

Normally there is no condensation on your windows during this period which therefore eliminates the need of the condensation control for a few months. Set knob **B** at the “SUMMER” position during this period.

Setting during the fall, winter and spring months:

- 1) Determine the humidity level in your house (bring the knob **B** counterclockwise to -20°C, then bring it back clockwise slowly until you hear a “click”).
- 2) Set knob **B** a notch under this temperature level or “click”.

- NOTES:**
1. Do not select a temperature below -20°C. This could lead to excessive dryness in the air causing discomfort for the occupants.
 2. When the humidity level is high, the unit automatically operates at maximum speed. If you change the setting of your “AIR SUPPLY” knob (**B**) at that time, it will remain at maximum speed until the humidity level is reduced, and then switch to the desired setting.

It is possible (and normal) to experience condensation on your windows when drastic changes in temperature happen (for example: -5°C [23°F] to -20°C [-4°F] within few hours). In that case, we suggest waiting a few days to allow the situation to stabilize.

2.4 USING THE VT2W MAIN CONTROL

Location: Located in the busiest area of the house.

Purpose: To adjust air supply and reduce condensation on windows.

ADJUSTING AIR SUPPLY CONTROL

a) Press “PUSH” (A) until the “MIN.,” “MAX.” or “INTERMITTENT” light indicator appears.

- When “MIN.” (minimum speed) is selected, if the knob B is set above the click, the unit will exchange in low speed with the outside and if it is set below the click, the unit will exchange on high speed with the outside until the desired humidity level has been reached.
- When “MAX.” (maximum speed) is selected, the unit will exchange on high speed with the outside either if the knob B is set below of above the click.
- Select “INTERMITTENT” (20 minutes minimum speed exchange every hour) when you are away from the house for a few days or when you deem the inside air too dry.

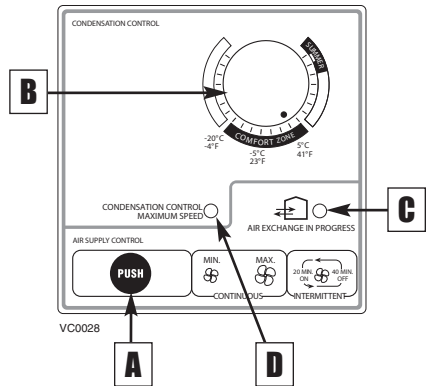

b) To **turn the unit off**, press “PUSH” (A) until the “MIN.,” “MAX.” and “INTERMITTENT” light indicators are all turned off.

NOTE: Optional controls will still be active. (Indicator (C) will be the only one to light up if an optional control is active).

ADJUSTING CONDENSATION CONTROL

Setting during the summer months:

Normally there is no condensation on your windows during this period which therefore eliminates the need of the condensation control for a few months. Set knob B at the “SUMMER” position during this period.

Setting during the fall, winter and spring months:

Ideally, maintain humidity level within the “**Comfort Zone**” (between 5°C and -20°C), which is the dark area around knob B.

To reduce humidity level, turn knob B clockwise a notch below the click. The unit will then switch to high speed, lighting up the **humidity light** (D indicator). When this light goes “OFF” (after a few hours or a few days), repeat the same procedure if excess humidity persists.

NOTE: If the air is too dry, set your knob B back to the “**Comfort Zone**” and use INTERMITTENT or turn off the unit.

When the **humidity light** (D indicator) goes “ON”, you can still change the mode of operation but your change will take place only when the light goes OFF.

2.4 USING THE VT2W MAIN CONTROL (CONT'D)

UNDERSTANDING THE LIGHT INDICATORS

LIGHTS UP when the control has detected excess humidity. This forces the motor to operate at high speed. The light indicator turns off when the humidity drops to the level associated with the temperature selected on knob **B**.

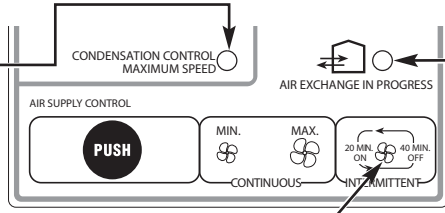

VC0028

LIGHTS UP when the system is operating (exhausting stale air from the house and drawing in fresh air).

LIGHTS UP when the intermittent mode has been selected.
FLASHES when maintenance is required (see Section 3).

2.5 USING THE HUMIDITY MAIN CONTROL

Location: Located in the busiest area of the house.

Purpose: To reduce condensation on windows.

During fall, winter and spring:

Adjust knob **A** to the desired maximum humidity level.

NOTE: Do not select a level below 30%. This could lead to excessive dryness in the air causing discomfort for the occupants.

During summer:

Adjust knob **A** to the "OFF" position or to the highest humidity setting if there is no "OFF" position on your control.

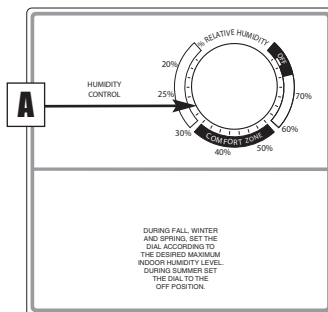

VC0071

Appearance may vary.

2.6 USING THE 3-POSITION SWITCH

Location: Located on the side of the unit, only on models HRV100H and HRV200H.

Purpose: To adjust air supply.

How to operate the unit on a daily basis:

Select "LOW" or "HIGH" speed:

- Select "LOW SPEED" for normal daily operation.
- Select "HIGH SPEED" for excess pollutants and humidity (parties, odors, smoke, etc.)

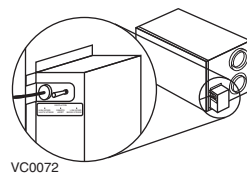

VC0072

How to turn the unit off: Select the "REMOTE" position.

NOTE: If the HRV100H or the HRV200H is connected to VT1W main control, the 3-position switch must be in "REMOTE" position.

⚠ WARNING

Optional controls or the humidity control can still activate the unit, even when it is in the "REMOTE" position. Unplug the unit to be absolutely sure it is off.

2.7 USING THE OPTIONAL CONTROLS

Location: Located in the bathroom or in other locations where there is temporary excess humidity or pollutants.

Purpose: To eliminate excess humidity produced by showers or other periodic activities producing pollutants.

20-MINUTE PUSH-BUTTON TIMER:

(AVAILABLE ONLY FOR HRV100H AND HRV200H MODELS)

Activate the push-button.

Results expected:

1. Motor speed: High for 20 minutes.
2. Indicator light goes "ON".
3. Air exchange indicator light goes "ON"
(VT2W wall control only).

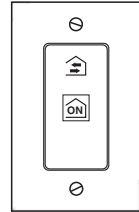

20/40/60-MINUTE PUSH-BUTTON TIMER:

(NOT AVAILABLE FOR HRV100H AND HRV200H MODELS)

Activate the push-button. Within 2 seconds, push once for 20 minutes, twice for 40 minutes or three times for a 60-minute activation.

Results expected:

1. Motor speed: High for 20, 40 or 60 minutes.
2. Indicator light goes "ON" and flashes every 5 seconds (one time to indicate a 20-minute operation, two times for a 40-minute, and three times for a 60-minute operation).
3. Air exchange indicator light goes "ON"
(VT2W wall control only).

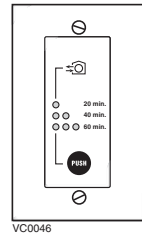

NOTE: To stop activation, push one more time.

60-MINUTE CRANK TIMER:

Activate the timer.

Results expected:

1. Motor speed: High for either 20, 40 or 60 minutes.
2. Air exchange indicator light goes "ON"
(VT2W wall control only).

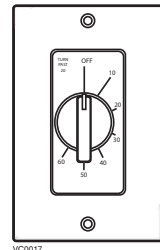

High speed activation time

Position of dial

20 minutes	1 to 19
40 minutes	20 to 39
60 minutes	40 to 60

3. MAINTENANCE

3.1 EVERY THREE MONTHS

WARNING

Dangerous voltage may be present. During maintenance and repairs, the unit must always be turned off, then unplugged. We take great care to minimize sharp edges; however, please proceed with caution when handling all components. When cleaning the unit, it is recommended to wear safety glasses and gloves.

Regular maintenance should be performed every 3 months. Annual maintenance should also take place every fall season.

1. Disconnect the power supply.

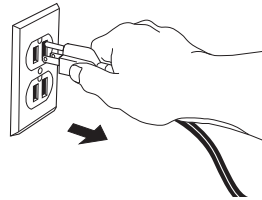

2. Unlatch the door. Lift the panel towards you. Hold it firmly and hit on the right side of the panel. The door should slide to the left.
3. Clean the inside of the **door** with a damp cloth.
4. Clean **filters**
 - Remove filters.
 - Vacuum to remove most of the dust.
 - Wash with a mixture of warm water and mild soap. You may add bleach if you wish to disinfect (one tablespoon per gallon). Rinse thoroughly. Shake filters to remove excess water and let dry.

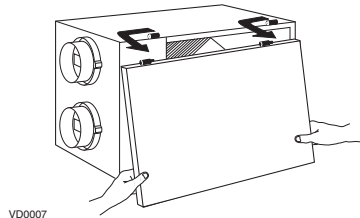

VD0007

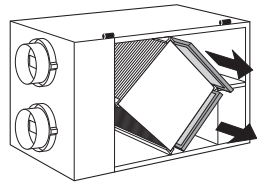

VD0100

NOTE: Washing the filters in the top tray of the dishwasher is possible, but the aluminum frame might tarnish.

3.1 EVERY THREE MONTHS (CONT'D)

5. Clean the **condensation tray** with a damp cloth.

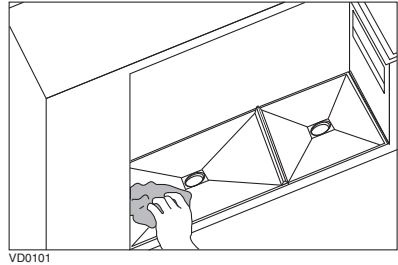

6. Check the exterior **air intake hood**:

CAUTION

Even a partial blocking of this air vent could cause the unit to malfunction.

- Make sure there are no leaves, twigs, ice or snow that could be drawn into the vent.
 - Clean if necessary.
7. Reassemble the components:
 - Filters
 - Door (The door is secured when you hear a click.)
 8. Reconnect the power supply.

3.2 ANNUAL MAINTENANCE (FALL)

⚠ WARNING

Dangerous voltage may be present. During maintenance and repairs, the unit must always be turned off, then unplugged. We take great care to minimize sharp edges; however, please proceed with caution when handling all components. When cleaning the unit, it is recommended to wear safety glasses and gloves.

Repeat steps 1 to 6 from the previous Section and continue with the following steps:

CAUTION

Handle the recovery core with care.

1. Clean the recovery core

- A- Polypropylene core (heat recovery unit)
 - Remove the recovery core.
 - Let it soak in a mixture of cold or lukewarm water and mild soap (dishwashing liquid).
 - Rinse thoroughly.
 - Shake the core to remove excess water and let it dry.
- B- Enthalpic paper core (heat and humidity recovery unit).

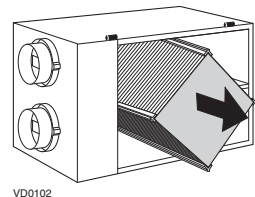

CAUTION

This type of recovery module cannot be washed with water.

- Remove the recovery core.
- Remove dust using a vacuum cleaner with a soft brush attachment.

3.2 ANNUAL MAINTENANCE (FALL) (CONT'D)

2. Clean the centrifugal fan wheels

A Remove the wing nut.

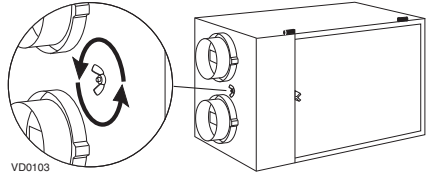

B Disconnect the blower motor wires.

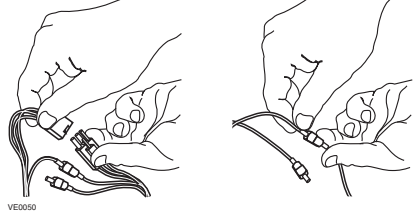

C Remove the blower assembly.

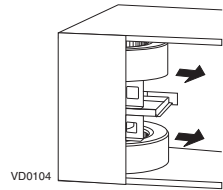

D Check for any dust accumulation on the blades.

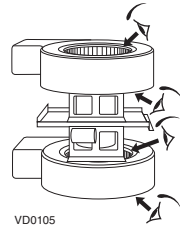

CAUTION

Do not oil the motor! It is already permanently lubricated.

E Clean with a small brush if necessary.

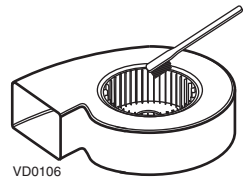

3. Put the components back in place (Section 1.1):

- Blower assembly (blower motor wires, wing nut)
- Recovery core
- Filters
- Door

4. Reconnect the power supply.

4. TROUBLESHOOTING

If you think your unit is malfunctioning, check some of the following:

	TYPE OF PROBLEM	TRY THIS...
1.	On Platinum wall control, there is no outside temperature displayed on screen  .	<ul style="list-style-type: none"> At its very start-up or after a power failure, it takes some minutes before the outside temperature appears on screen. Set the wall control on MIN or MAX in VENT Mode. If the problem is not solved by the above, contact your installer.
2.	On Platinum wall control, error code E1, E3 or E4 appears on screen.	<ul style="list-style-type: none"> Contact your installer.
3.	Nothing works.	<ul style="list-style-type: none"> See if the unit is plugged in. See if the unit is receiving power from the house circuit breaker or fuse.
4.	All light indicators on the wall control are flashing.	<ul style="list-style-type: none"> Unplug the unit, wait 30 seconds, then reconnect. If the problem is not solved, contact your installer.
5.	Noisy unit.	<ul style="list-style-type: none"> Clean the fan assembly (see Section 3.2). If the problem is not solved, contact your installer.
6.	Condensation on windows. (Air too humid.)	<ul style="list-style-type: none"> Adjust the humidity control knob as per instructions (see Section 2). Operate the unit at maximum speed (MAX.) during activities generating excess humidity (family gatherings, extra cooking, etc.). Leave curtains half-open to allow air circulation. Store all firewood in a close room with a dehumidifier or in a well ventilated room, or store the wood outside. Keep the temperature in your house above 18°C (64°F).
7.	Air too dry.	<ul style="list-style-type: none"> Do not adjust your Humidity Control below -20°C (-4°F). Operate the unit at low speed (MIN.). Temporarily switch to the intermittent mode. Temporarily use a humidifier.
8.	Air too cold at the air supply grille.	<ul style="list-style-type: none"> Make sure the outside hoods are not blocked. Operate the unit at low speed (MIN.). Have the system balancing checked. Have the unit defrost system checked. Install a duct heater.

If the problem persists, contact your installer at the telephone number and address indicated on the first page of this manual or call one of the following phone numbers for assistance:

• 1-800-567-3855 (Canada)

• 1-800-637-1453 (United States)