

YAMAHA[®]

**AUTHORIZED
PRODUCT MANUAL**

MT8X
MULTITRACK CASSETTE RECORDER

YAMAHA

MULTITRACK CASSETTE RECORDER

MT8X

OPERATION MANUAL

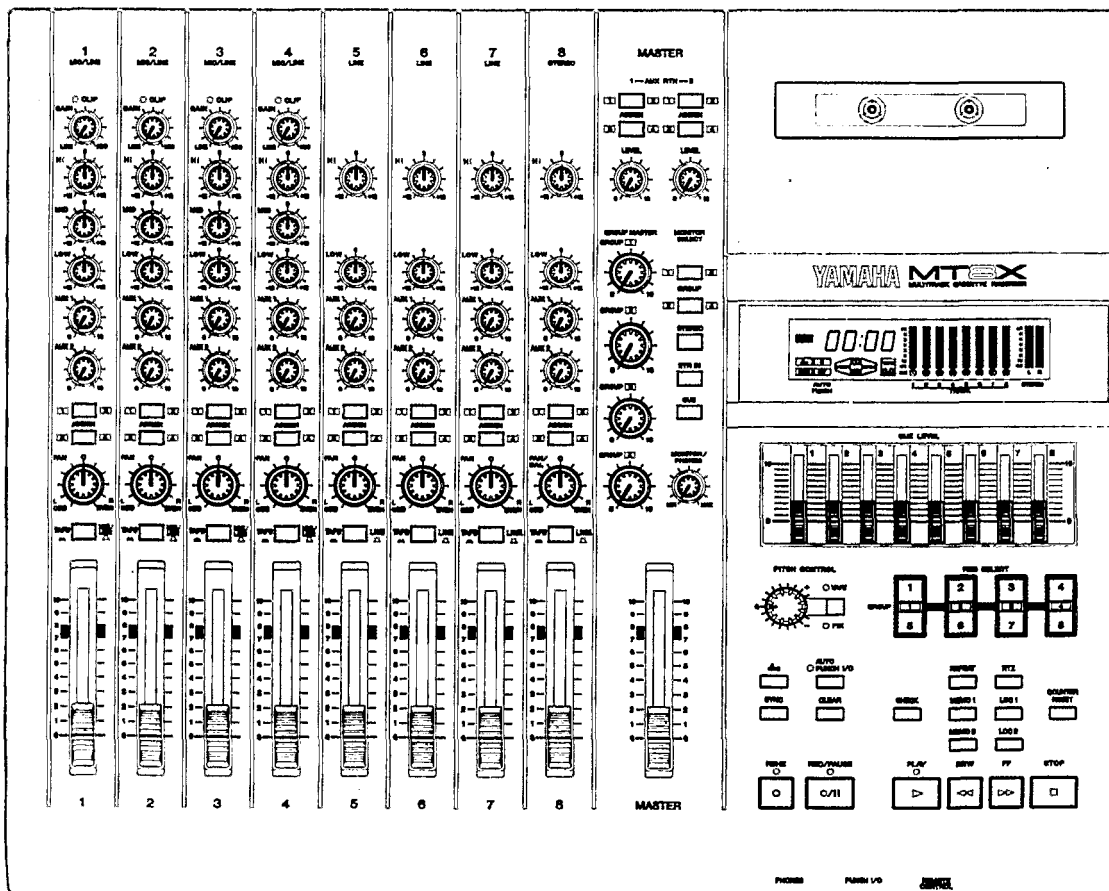

• Explanation of Graphical Symbols

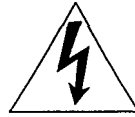
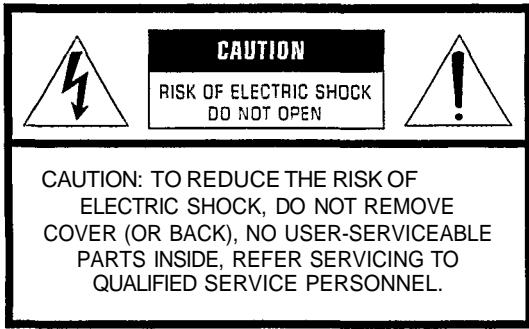

The lightning flash with arrowhead symbol, within an equilateral triangle, is intended to alert you to the presence of uninsulated "dangerous voltage" within the product's enclosure that may be of sufficient magnitude to constitute a risk of electric shock to persons.



The exclamation point within an equilateral triangle is intended to alert you to the presence of important operating and maintenance (servicing) instructions in the literature accompanying the appliance.

SAFETY INSTRUCTIONS

- 1 Read Instructions - All the safety and operating instructions should be read before the appliance is operated.
- 2 Retain Instructions - The safety and operating instructions should be retained for future reference.
- 3 Heed Warnings - All warnings on the appliance and in the operating instructions should be adhered to.
- 4 Follow Instructions - All operating and use instructions should be followed.
- 5 Water and Moisture - The appliance should not be used near water - for example, near a bathtub, washbowl, kitchen sink, laundry tub, in a wet basement, or near a swimming pool, and the like.
- 6 Carts and Stands - The appliance should be used only with a cart or stand that is recommended by the manufacturer.
- 6A An appliance and cart combination should be moved with care. Quick stops, excessive force, and uneven surfaces may cause the appliance and cart combination to overturn. 
- 7 Wall or Ceiling Mounting - The appliance should be mounted to a wall or ceiling only as recommended by the manufacturer.
- 8 Ventilation - The appliance should be situated so that its location or position does not interfere with its proper ventilation. For example, the appliance should not be situated on a bed, sofa, rug, or similar surface, that may block the ventilation openings; or placed in a built-in installation, such as a bookcase or cabinet that may impede the flow of air through the ventilation openings.
- 9 Heat - The appliance should be situated away from heat sources such as Heat registers, stoves, or other appliances (including amplifiers) that produce heat.
- 10 Power Sources - The appliance should be connected to a power supply only of the type described in the operating instructions or as marked on the appliance.
- 11 Grounding or Polarization - The precautions that should be taken so that the grounding or polarization means of an appliance is not defeated.
- 12 Power-Cord Protection - Power-supply cords should be routed so that they are not likely to be walked on or pinched by items placed upon or against them, paying particular attention to cords at plugs, convenience receptacles, and the point where they exit from the appliance.
- 13 Cleaning - The appliance should be cleaned only as recommended by the manufacturer.
- 14 Nonuse Periods - The power cord of the appliance should be unplugged from the outlet when left unused for a long period of time.
- 15 Object and Liquid Entry - Care should be taken so that objects do not fall and liquids are not spilled into the enclosure through openings.
- 16 Damage Requiring Service - The appliance should be serviced by qualified service personnel when:
 - A. The power-supply cord or the plug has been damaged; or
 - B. Objects have fallen, or liquid has been spilled into the appliance; or
 - C. The appliance has been exposed to rain; or
 - D. The appliance does not appear to operate normally or exhibits a marked change in performance; or
 - E. The appliance has been dropped, or the enclosure damaged.
- 17 Servicing - The user should not attempt to service the appliance beyond that described in the operating instructions. All other servicing should be referred to qualified service personnel

FCC INFORMATION

1. IMPORTANT NOTICE : DO NOT MODIFY THIS UNIT!

This product, when installed as indicated in the instructions contained in this manual, meets FCC requirements. Modifications not expressly approved by Yamaha may void your authority, granted by the FCC, to use the product.

2. IMPORTANT : When connecting this product to accessories and/or another product use only high quality shielded cables. Cable/s supplied with this product MUST be used. Follow all installation instructions. Failure to follow instructions could void your FCC authorization to use this product in the USA.

3. NOTE : This product has been tested and found to comply with the requirements listed in FCC Regulations, Part 15 for Class "B" digital devices. Compliance with these requirements provides a reasonable level of assurance that your use of this product in a residential environment will not result in harmful interference with other electronic devices.

This equipment generates/uses radio frequencies and, if not installed and used according to the instructions found in the users manual, may cause interference harmful to the operation of other electronic devices.

Compliance with FCC regulations does not guarantee that interference will not occur in all installations. If this product is found to be the source of interference, which can be determined by turning the unit "OFF" and "ON", please try to eliminate the problem by using one of the following measures:

Relocate either this product or the device that is being affected by the interference.

Utilize power outlets that are on different branch (circuit breaker or fuse) circuits or install AC line filter/s.

In the case of radio or TV interference, relocate/reorient the antenna. If the antenna lead-in is 300 ohm ribbon lead, change the lead-in to coaxial type cable.

If these corrective measures do not produce satisfactory results, please contact the local retailer authorized to distribute this type of product. If you can not locate the appropriate retailer, please contact Yamaha Electronics Corp., U.S.A. 6660 Orangethorpe Ave, Buena Park, CA 90620.

The above statements apply ONLY to those products distributed by Yamaha Corporation of America or its subsidiaries.

Dette apparat overholder det gaeldende EF-direktiv vedrørende radiostøj.

Cet appareil est conforme aux prescriptions de la directive communautaire 87/308/CEE.

Diese Geräte entsprechen der EG-Richtlinie 82/499/EWG und/oder 87/308/EWG.

This product complies with the radio frequency interference requirements of the Council Directive 82/499/EEC and/or 87/308/EEC.

Questo apparecchio è conforme al D.M.13 aprile 1989 (Direttiva CEE/87/308) sulla soppressione dei radiodisturbi.

Este producto está de acuerdo con los requisitos sobre interferencias de radio frecuencia fijados por el Consejo Directivo 87/308 CEE.

IMPORTANT NOTICE FOR THE UNITED KINGDOM

Connecting the Plug and Cord IMPORTANT

THE WIRES IN THE MAINS LEAD ARE COLOURED IN ACCORDANCE WITH THE FOLLOWING CODE:

Blue: NEUTRAL

Brown: LIVE

As the colours of the wires in the mains lead of this apparatus may not correspond with the coloured markings identifying the terminals in your plug, proceed as follows:

The wire which is coloured BLUE must be connected to the terminal which is marked with the letter N or coloured BLACK. The wire which is coloured BROWN must be connected to the terminal which is marked with the letter L or coloured RED. Making sure that neither core is connected to the earth terminal of the three pin plug.

CANADA

THIS DIGITAL APPARATUS DOES NOT EXCEED THE "CLASS B" LIMITS FOR RADIO NOISE EMISSIONS FROM DIGITAL APPARATUS SET OUT IN THE RADIO INTERFERENCE REGULATION OF THE CANADIAN DEPARTMENT OF COMMUNICATIONS.

LE PRESENT APPAREIL NUMERIQUE N'EMET PAS DE BRUITS RADIOELECTRIQUES DEPASSANT LES LIMITES APPLICABLES AUX APPAREILS NUMERIQUES DE LA "CLASSE B" PRESCRITES DANS LE REGLEMENT SUR LE BROUILLAGE RADIOELECTRIQUE EDICTE PAR LE MINISTERE DES COMMUNICATIONS DU CANADA.

CONGRATULATIONS

Your MT8X Multitrack Cassette Recorder is a powerful recording tool that will enable you to work with sound in many ways. No other multitrack cassette recorder offers the straightforward simplicity and ease-of-use of the MT8X. Whether you need to record acoustic instruments or voice using microphones, electronic instruments and line-level sources, or a creative blend of the two, the MT8X makes the process of building tracks extraordinarily smooth and simple. You can simply record and remix eight tracks, or use the multitrack "ping-pong" recording technique to individually record many independent parts adding sound layer by layer until you create exactly the arrangement and texture your imagination demands with its ability to record on all eight tracks, or in any combination, MT8X is the ideal choice for recording bands or layering tracks at home. And, because it's a YAMAHA, you know that the MT8X will give you the very finest sound quality and overall performance available.

In order to make use of the MT8X's many features and obtain maximum performance, we urge you to read this operation manual thoroughly and keep it in a safe place for future reference.

CONTENTS

PRECAUTIONS.....	5
FEATURES	6
STRUCTURE OF THE MT8X	7
CONTROLS AND THEIR FUNCTIONS.....	8
MIXER (CHANNEL INPUT SECTION)	8
MIXER (MASTER SECTION).....	9
RECORDER	10
DISPLAY.....	12
FRONT PANEL	12
REAR PANEL	13
RECORDING METHODS.....	14
MONITOR.....	14
INITIAL RECORDING	15
OVERDUBBING.....	16
PITCH CONTROL	16
PING-PONG RECORDING	17
PUNCH-IN/OUT RECORDING.....	20
SYNC RECORDING.....	23
MIXDOWN.....	27
SETTING THE RECORDING LEVELS.....	28
RECORDING EXAMPLES.....	29
RECORDING PLAN.....	29
RECORDING EXAMPLE 1:	
A basic recording (overdubbing)	31
RECORDING EXAMPLE 2:	
An advanced recording	35
CONNECTION EXAMPLE	40
TROUBLESHOOTING	41
MAINTENANCE.....	42
SPECIFICATIONS.....	43
GENERAL SPECIFICATIONS.....	43
DIMENSIONS.....	44
BLOCK DIAGRAM.....	129

PRECAUTIONS

1. AVOID EXCESSIVE HEAT, HUMIDITY, DUST AND VIBRATION

Keep the unit away from locations where it is likely to be exposed to high temperatures or humidity — such as near radiators, stoves, etc. Also avoid locations which are subject to excessive dust accumulation or vibration which could cause mechanical damage.

2. AVOID PHYSICAL SHOCKS

Strong physical shocks to the unit can cause damage. Handle it with care.

3. DO NOT OPEN THE CASE OR ATTEMPT REPAIRS OR MODIFICATION YOURSELF

This product contains no user-serviceable parts. For other than routine cleaning, refer maintenance to qualified YAMAHA personnel. Opening the case and/or tampering with the internal circuitry will void the warranty.

4. MAKE SURE POWER IS OFF BEFORE MAKING OR REMOVING CONNECTIONS

Always turn the power OFF prior to connecting or disconnecting cables. This is important to prevent damage to the unit itself as well as other connected equipment.

5. HANDLE CABLES CAREFULLY

Always plug and unplug cables — including the AC cord — by gripping the connector, not the cord.

6. CLEAN WITH A SOFT DRY CLOTH

Never use solvents such as benzine or thinner to clean the unit. Wipe clean with a soft, dry cloth.

7. ALWAYS USE THE CORRECT POWER SUPPLY

This unit is sold with the appropriate power specifications for the local area (power supply voltage and power consumption are listed on the bottom panel). If you move to a different area that might have a different AC mains voltage, however, be sure to check with your nearest YAMAHA dealer before using this unit.

8. KEEP THE HEADS AND TAPE PATH CLEAN

To ensure consistent high performance and sound quality from this unit, it is important to clean the head and tape path regularly (ideally before each recording session). To do this, use a cleaning kit specifically designed for use with cassette tape equipment.

9. USE ONLY HIGH-QUALITY CHROME CASSETTE TAPE

This unit is designed to be used only with Chromeposition tape, and will not work properly with Ferrichrome tape formulations. CrO₂ tape (Bias: HIGH; EQ:70μs) should be used. Also, the use of tapes longer than 90 minutes (C-120, etc.) is not recommended because they exhibit poorer performance, and can cause an equipment failure.

10. USE A CASSETTE TAPE PROPERLY

- This unit is designed to be used only with Chrome position tape. CrO₂ tape (HIGH position, TYPE II) should be used. With some tapes, it may be impossible to obtain normal sound quality or characteristics because of problems such as distortion of the frequency characteristic. If this happens, try using a different type of tape. TDK SA 46 - 90 and Maxell UDII 46 - 90 are recommended.
- This unit is an 8-track, 8-channel tape recorder with a tape speed of 9.5 cm/s, unlike ordinary cassette recorders which have 4 tracks, 2 channels, and a tape speed of 4.8 cm/s, so this unit can not record or playback ordinary cassette tapes. Also, since this unit uses special heads, it is not compatible with tapes recorded on 8-track recorders from other manufacturers.
- New tapes are tightly wound, so fast forward and rewind them once to loosen them up. This improves the recording/playback characteristics. Also, it is better not to use the first and last 20 seconds of the tape. Sometimes these sections are wound in such a way that the desired characteristics are not obtained.
- When loading a cassette tape, check it carefully to make sure the tape is not loose, then load the tape firmly into the cassette compartment so that it is not loose or otherwise out of place. If the tape is not loaded properly, the desired characteristics may not be obtained.

11. USE THE dbx SWITCH PROPERLY

To play back a tape with normal sound quality, turn the **dbx** switch on for the tape recorded with the **dbx** on, and for the tape recorded with the **dbx** off, turn this switch off.

* **dbx** is a trademark of **dbx** Incorporated.

12. CHECK THE ACCESSORIES

Please check to see that you have all the accessories, power cords and cotton swabs.

FEATURES

● GENERAL

The MT8X consists of an 8-channel recording mixer section and an 8-track recorder section inside a compact enclosure. Independent recording and playback are possible for each separate track, so that high-quality multi-track recording can be easily obtained.

● MIXER

The mixer section is equipped with independent stereo buses for more flexible use of this unit.

Continuously variable gain controls are provided for channels 1-4. These are applicable to any input source, including microphone input and line input.

Insert I/O jacks are provided for channels 1 and 2. These jacks allow external signal processors to be connected directly to this unit.

Dual AUX SEND and AUX RETURN (stereo) jacks add effects from the connected external signal processors to each channel as required.

2TR IN jacks are provided to make monitoring of the completed tape which has been mixed down in stereo easier.

● RECORDER

A dbx noise reduction system will provide substantial noise reduction and a wide dynamic range.

An automatic punch-in/out recording function and a rehearsal function make punch-in/out recording easier and more accurate.

A pitch control function makes it possible to vary the tape speed within a range of approximately $\pm 12\%$. This is useful in cases such as carrying out pitch compensation at overdubbing.

A large multi-functional display shows the recording and playback level, recording track and tape counter together, so it is easy to see and very helpful for operations.

A full complement of locate functions such as RTZ (Return To Zero) and LOC (Locate) are provided.

A full-logic mechanism in the recorder makes the process of creating complex multi-track recording smooth and simple.

STRUCTURE OF THE MT8X

This unit can be divided into three sections: a "mixer", a "recorder" and "bus lines" which link the previous two sections.

■ MIXER:

The mixer has 8 input channels. It adjusts input signals at each respective channel and sends them to the bus lines. The signals input to each channel of the mixer can be switched to either input signals (LINE) or tape playback signals (TAPE). When TAPE is selected, the playback signals on each track are input to the corresponding channel, in such a way that the playback signals on track 1 of the recorder are input to channel 1, the playback signals on track 2 of the recorder are input to channel 2, and so on. After the tone and volume of the input signals are adjusted at the equalizer and channel faders, they are sent to the desired bus lines using the PAN controls and ASSIGN switches.

■ BUS LINES:

There are 4 main bus lines (group buses) which receive the input signals from each respective channel of the mixer. If signals from two or more mixer channels are input to a bus line, these signals are all overlaid (mixing).

RECORDER:

The cassette recorder records the signals from the bus lines. In addition, it also sends the playback signals to the TAPE OUT jacks on the rear panel and to the mixer.

For recording, there is a relationship between group buses and recorder tracks as shown in the following table.

Group Bus No.		Track on which signals from the group bus can be recorded
GROUP1	→	Track 1 or Track 5
GROUP2	→	Track 2 or Track 6
GROUP3	→	Track 3 or Track 7
GROUP4	→	Track 4 or Track 8

The current of input signals at each channel

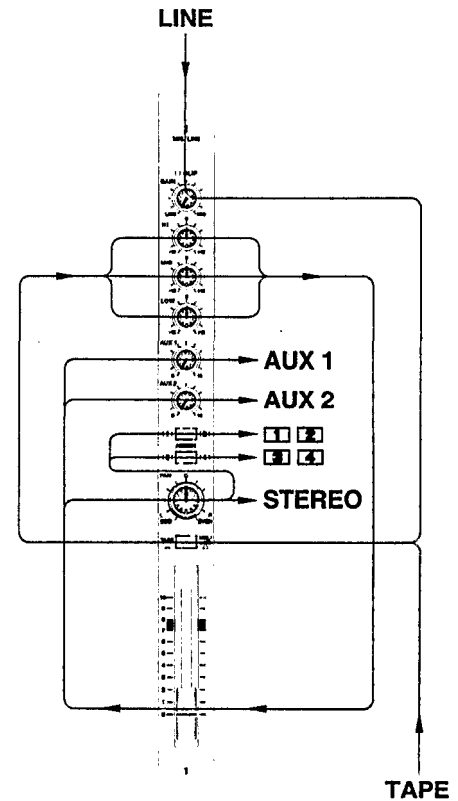

As shown in the table on the left, there are as many as 4 tracks which can be recorded at the same time.

In addition, signals from odd-numbered groups (ODD) are recorded to odd-numbered tracks, and signals from even-numbered groups (EVEN) are recorded to even-numbered tracks.

The current of signals from a channel to the recorder

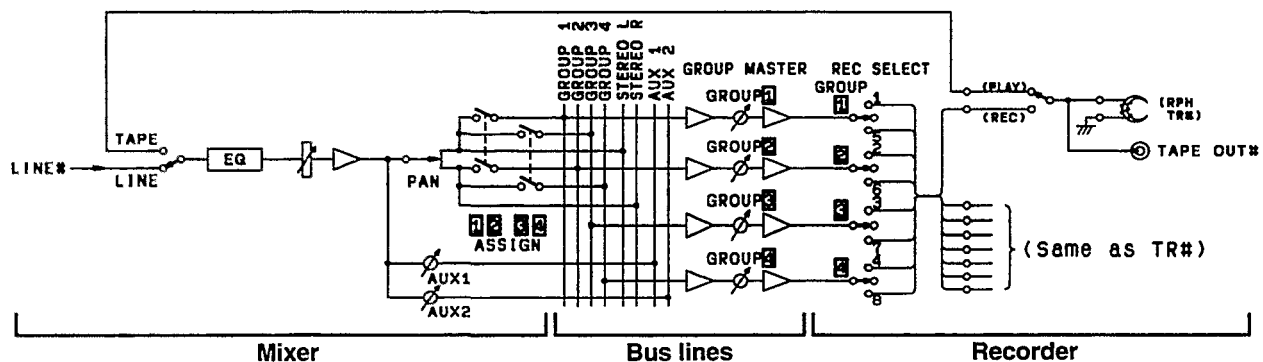

CONTROLS AND THEIR FUNCTIONS

* The head number of each control name corresponds to the same number of the illustration at the back of the attached PLANNING SHEET.

■ MIXER (CHANNEL INPUT SECTION)

① GAIN Control and CLIP Indicator

This control adjusts the level of signals from the microphone or instruments connected to the **MIC/LINE INPUT** jacks.

If the **CLIP** indicator above each of the knobs (1-4) remains illuminated, it means that the input level is too high. In this case, adjust to an optimum level so that the indicator flickers momentarily at the maximum volume level by using the **GAIN** control or the output level of the connected unit. (**GAIN** controls are provided only for channels 1-4).

② Equalizer Controls

The high, middle and low band frequency levels can be controlled individually within a range of ± 12 dB based from the standard frequencies given below.

HIGH: Standard frequency10 kHz

MID: Standard frequency 1 kHz

LOW: Standard frequency100 Hz

When the control is at the "0" position, a flat frequency characteristic is obtained. (However, channels 5-8 are provided with **HIGH** and **LOW** controls only.)

The equalizer's frequency characteristics

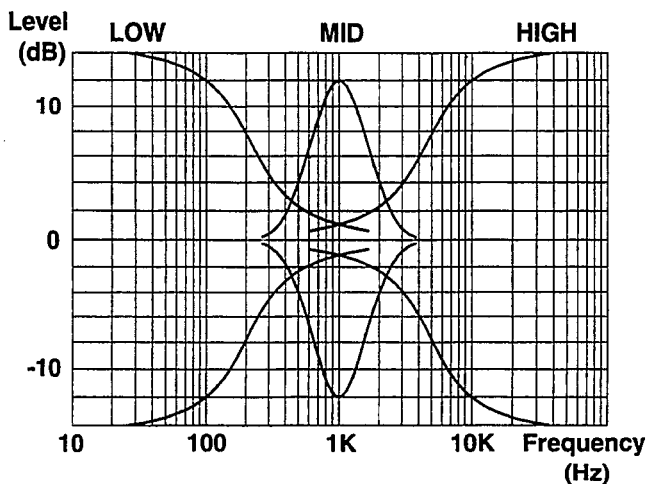

③ AUX 1 and 2 Controls

The **AUX** controls are used to adjust the level of signals input to a unit such as an external signal processor connected to the **AUX SEND** jack(s). The signals adjusted by these controls are sent from the AUX bus line to the connected signal processor(s) via the **AUX SEND** jack(s). The signals then return to this unit's group buses and stereo buses via the **AUX RETURN** jacks.

④ ASSIGN Switches

These switches are used to send the signals which are adjusted by the **PAN** control to the respective group buses.

These switches and the **PAN** control can be used to distribute signals freely between groups 1-4. On the other hand, signals are always sent to the stereo buses.

⑤ PAN Control

This control is used for adjusting balance and position of signals which was adjusted by the **channel fader**, when the signals are sent to the group buses or stereo buses.

Signals are distributed as follows:

ODD/L: Signals are sent to Groups 1 and/or 3 Stereo L).

EVEN/R: Signals are sent to Groups 2 and/or 4 Stereo R).

If the control is set to the center position, signals will be equally distributed to both the ODD/L and EVEN/R groups or channels.

⑥ Input Selector Switch

This switch is used to select the input signal (either TAPE or MIC/LINE) for each channel.

This switch can also be used to turn each channel ON/OFF when mixing down recorded sources.

TAPE:

Set to this position in order to input an already-recorded signal to the mixer.

MIC/LINE (ch 1-4), LINE (ch 5-8):

Set to this position when adding an input signal from an instrument such as an electric guitar or a keyboard which is connected to the **MIC/LINE (LINE) INPUT** jacks on the rear panel.

A microphone may also be connected for channels 1-4.

⑦ Channel Fader

The **channel fader** is used to adjust the level of the input signals.

When mixing channels, input level balance between channels can be adjusted with these faders.

The optimum position is at 7-8 on the scale.

* Set the fader to "0" for channels which are not being used.

■ MIXER (MASTER SECTION)

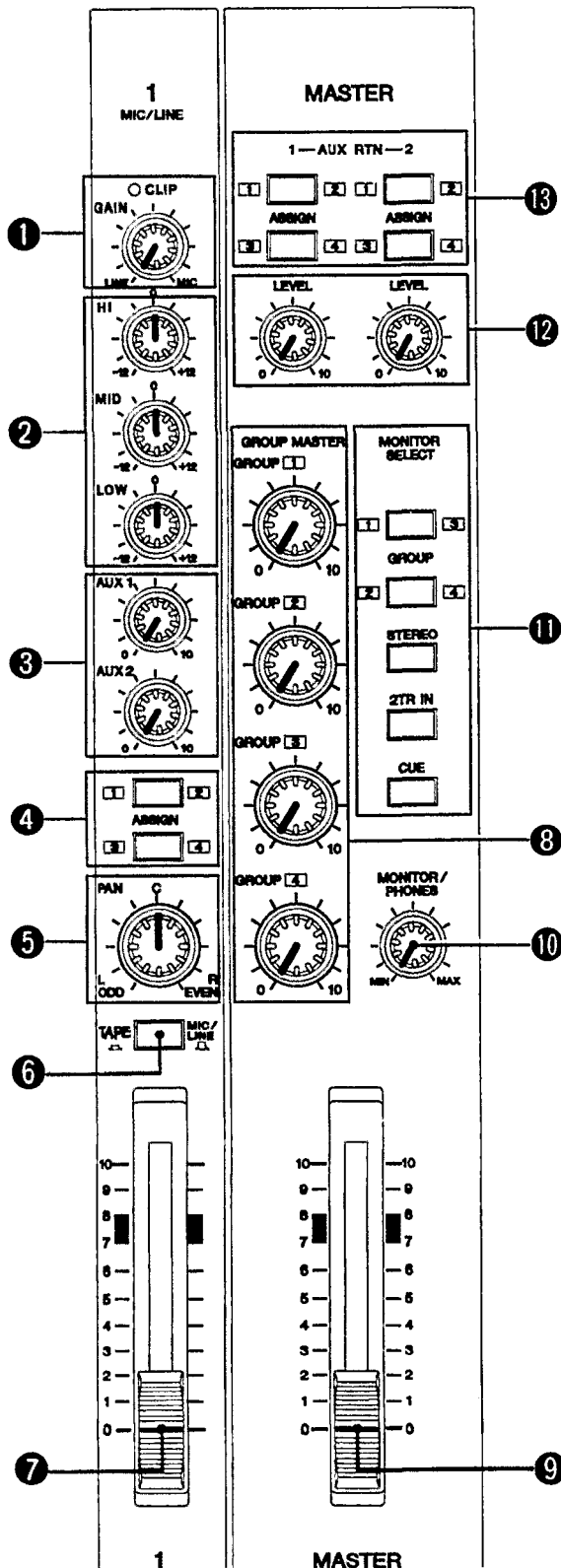

8 GROUP MASTER Controls

These controls are used to adjust the level of each group when the signals from each group bus are to be recorded to tape. The signals adjusted by these controls are sent to the tracks selected by the **REC SELECT** switches.

9 STEREO Fader

The **MASTER** fader adjusts the level of the stereo bus signals.

The optimum position is at "7-8" on the scale.

10 MONITOR/PHONES Control

This control is used to adjust the sound output level at the **PHONES** jack on the front panel and at the **MONITOR OUT** jacks on the rear panel.

11 MONITOR SELECT Switches

These switches are used to monitor the group bus and stereo bus signals, signals input to the **2TR IN** jacks and the playback signals of the cassette tape. If all switches are pressed, all of the signals can be simultaneously monitored.

GROUP

Each of these switches is used to monitor the bus signals for groups 1 and 3 or groups 2 and 4 in monaural.

If both the switches are pressed, signals can be monitored in stereo; groups 1 and 3 for channel L and groups 2 and 4 for channel R.

STEREO

This switch is used to monitor the stereo bus signals.

2TR IN

This switch is used to monitor the signals input to the **2TR IN** jacks.

CUE

This switch is used to monitor the playback signals on tracks of the cassette tape.

For a track being recorded, the recording signals will be monitored.

12 AUX RTN LEVEL Controls

These controls are used to adjust the level of the signals input to the **AUX RETURN** jacks.

13 AUX RTN ASSIGN Switches

These switches are used to select the group bus to which the signals from the **AUX RETURN** jacks will be sent. On the other hand, signals are always sent to the stereo buses.

RECORDER

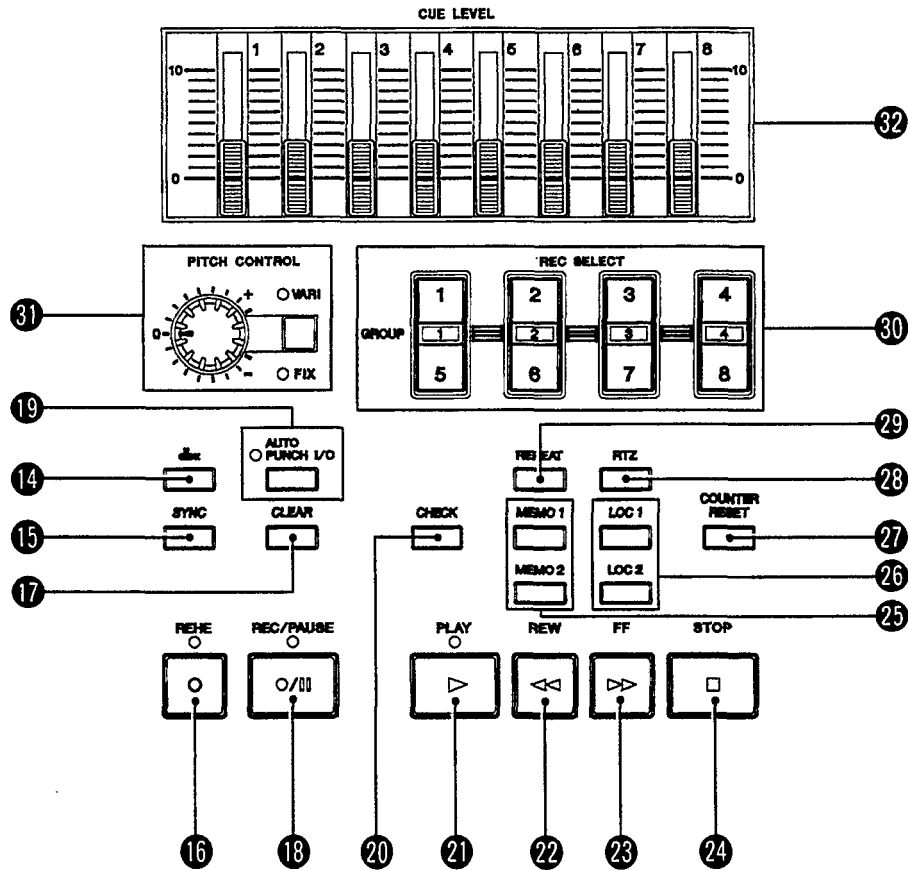

14 dbx Switch

This switch is used to turn the internal dbx noise reduction system on and off. The **dbx** system will operate when the switch is turned on. The **dbx** system becomes on at the time when the power is turned on.

The **dbx** system has no effect on track 8 when the **SYNC** switch is on. This is because track 8 is used for recording the FSK signal on SYNC recording.

15 SYNC Switch

When performing SYNC recording or playback with the **dbx** on, turn this switch on, and record FSK signals on track 8. (See "SYNC RECORDING" on page 23.)

16 REHE Button and Indicator

This button is for carrying out a recording rehearsal. If this button is pressed, the indicator illuminates. After the track(s) to be recorded is selected with the **REC SELECT** switches, if this button is pressed and then the **PLAY** button is pressed, a pseudo-recording can be performed. In this condition, this unit functions in the same way as actual recording, though recording is not performed. This is useful for practicing punch-in/out recording and for checking recording levels.

17 CLEAR Button

This button clears the setting of memory points 1 and 2. When automatic punch-in/out is activate (**AUTO PUNCH I/O** indicator illuminates) this button clears the automatic punch-in/out setting but does not clear the memory point setting.

18 REC/PAUSE Button and Indicator

This button is used to actually record signals onto a cassette tape. If this button is pressed after selecting a track to be recorded by using a **REC SELECT** switch, the indicator will illuminate and this unit enters into the recording standby mode. If the **PLAY** button is then pressed, recording will begin.

If no track to be recorded has already been designated by using the **REC SELECT** switches, the indicator will flash rapidly when this button is pressed.

19 AUTO PUNCH I/O Button and Indicator

This button cancels the automatic punch-in/out function. (See "4. Punch-in/out using the automatic punch-in/out function" on page 21.)

20 CHECK Button

This button displays the memory point.

If the **MEMO 1** button is pressed while holding down the **CHECK** button, MEMO [1] will flash on the display and the tape counter value will be shown on the display. If the **MEMO 2** button is pressed while holding down the **CHECK** button, the tape counter value for **MEMO 2** will be shown on the display.

21 PLAY Button and Indicator

This button is used for playing the cassette tape.

22 REW Button

This button is used to rapidly rewind the cassette tape.

If this button is pressed and held down for more than one second, the tape will be rewound at higher speed.

23 FF Button

This button is used to rapidly wind forward the cassette tape.

If this button is pressed and held down for more than one second, the tape will be wound forward at higher speed.

24 STOP Button

This button stops the tape running.

25 MEMO 1 and 2 Buttons

These buttons memorize the current tape counter value as memory points.

If the **MEMO 1** button is pressed, memory point 1 is stored and "MEMO 1" is shown on the display.

If the **MEMO 2** button is pressed, memory point 2 is stored and "MEMO 2" is shown on the display.

The stored memory points can be erased by pressing the **CLEAR** button, by turning off the main power supply or by removing the cassette tape.

26 LOC 1 and LOC 2 Buttons

These buttons are for locating the memory points stored using the **MEMO 1** and **MEMO 2** buttons.

If the **LOC 1** button is pressed, the tape rapidly forwards or rewinds to the memory point 1, and when **LOC 2** is pressed, the tape rapidly forwards or rewinds to the memory point 2.

27 COUNTER RESET Button

This button resets the tape counter to "00:00". The memory points on the tape which were set by using the **MEMO 1** and **2** buttons will remain unchanged, even if values of the tape counter are changed by pressing this button.

28 RTZ Button

If the **RTZ** (Return To Zero) button is pressed, the tape is rapidly rewound to the point where the counter reads "00:00".

29 REPEAT Button

Pressing this button repeatedly plays back the section between the two memory points which were set using the **MEMO 1** and **MEMO 2** buttons.

If either one of the memory points has not been set, the section between 00:00 and the single memory point will be played back repeatedly.

If this button is pressed once more, the repeat playback is canceled. The repeat playback will be continued up to 16 times unless this function is canceled.

30 REC SELECT Switches

These switches are used to select the tracks (1 - 8) on which the group signals sent to the recorder are to be recorded.

The relationship of a group bus and the tracks on which signals from the group bus can be recorded are as follows.

Group 1 → Track 1 or 5

Group 2 → Track 2 or 6

Group 3 → Track 3 or 7

Group 4 → Track 4 or 8

Signals cannot be simultaneously recorded to two different tracks in the same group, for instance tracks 1 and 5. Simultaneous recording is thus possible for up to four tracks.

If the switch is pressed once again, the setting is canceled.

31 PITCH Control (Knob, Switch and Indicators)

This control is used to adjust the running speed of the tape. (See "PITCH control" on page 16.)

If the switch is pressed to enter into the FIX mode (the green indicator illuminates), the tape speed is set to the preset condition and cannot be changed.

32 CUE LEVEL Controls

These controls are used to adjust the monitoring level of the recording/playback signals. Adjustment can be done for each track respectively.

33 Cassette Compartment

■ DISPLAY (34)

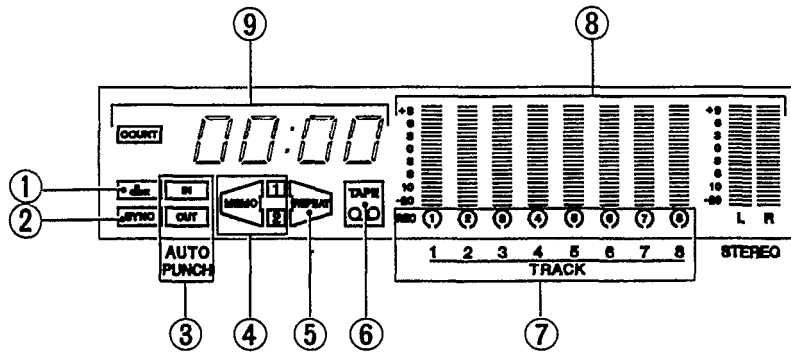

① dbx Indicator

This indicator illuminates when the **dbx** system is on.

② SYNC Indicator

This indicator illuminates when the **SYNC** switch is pressed to be turned on.

③ Automatic Punch-in/out Indicator

This indicator displays the automatic punch-in/out recording status.

④ MEMO 1 and 2 Indicators

These indicators illuminate when the respective memory points have been set.

If the **MEMO 1** button is pressed, [1] flashes three times and then illuminates.

If the **MEMO 2** button is pressed, [2] flashes three times and then illuminates.

⑤ REPEAT Indicator

This indicator illuminates while the repeat playback is being performed.

⑥ TAPE Indicator

This indicator illuminates when a cassette tape is inserted. If a cassette tape has not yet been inserted, the indicator will flash if a button for tape running is pressed.

⑦ REC Select Indicators

The indicator corresponding to the track selected by a **REC SELECT** switch flashes to indicate that recording is possible to the track. If the **REC/PAUSE** button is pressed at this time, the indicator changes from flashing to illuminating and this unit enters into the recording standby mode.

⑧ Level Meter

The level meter displays the recording or playback level of each track, or the signal level at the stereo buses within a range of -20 dB - +9 dB.

⑨ Tape Counter

The tape counter is displayed by minutes and seconds. The time displayed is as close as possible to the actual time elapsed, but there will be a small amount of error depending on the type of tape being used. The range of errors are as follows:

C-46: ±13% (±1 min. 30 sec.)

C-60: ±10% (±1 min. 30 sec.)

C-90: ±13% (±3min.)

■ FRONT PANEL

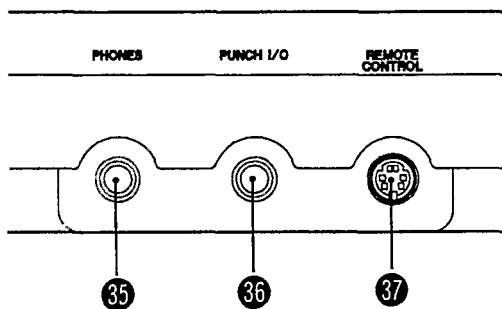

③⑤ PHONES Jack

Connect headphones (8-40 Ω) to this jack.

③⑥ PUNCH I/O Jack

When using a footswitch (sold separately) in punch-in/out recording, connect the footswitch to this jack. (See "PUNCH-IN/OUT RECORDING" on page 20.)

③⑦ REMOTE CONTROL Jack

When using remote controller RCM1 (sold separately) to operate the recorder, connect the remote controller to this jack.

A view from over the top panel.

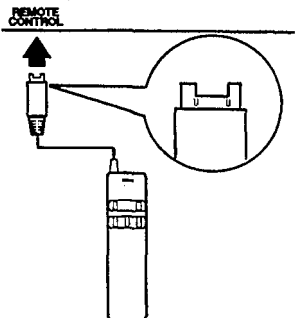

REAR PANEL

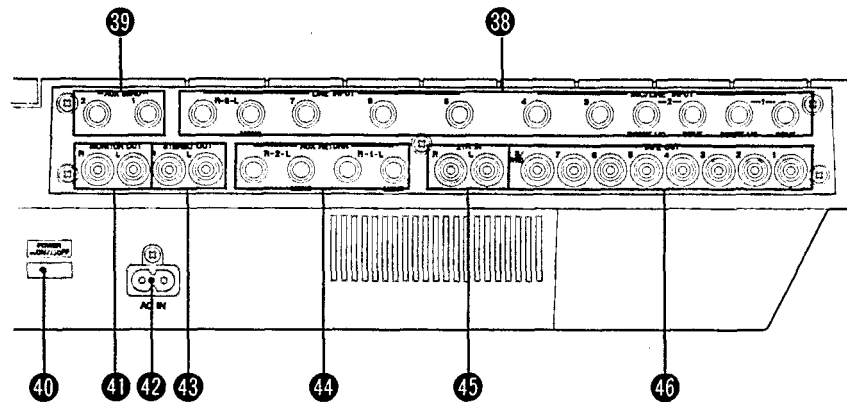

38 MIC/LINE INPUT, LINE INPUT and INSERT I/O Jacks

- Input Impedance: 10 k Ω , 10 k Ω , 10 k Ω
 - Rated Input Level: -10 dB to -50 dB, -10 dB, -10 dB
- MIC/LINE INPUT jacks are provided for channels 1-4, and only LINE INPUT jacks are provided for channels 5-8. (For channel 8 only, stereo input jacks are provided.) In addition, INSERT I/O jacks are provided for channels 1 and 2. The Insert I/O cable as shown in the following figure is required when using INSERT I/O.

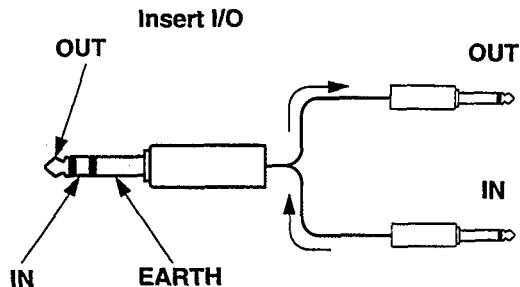

39 AUX SEND 1 and 2 Jacks

- Output Impedance: 1 k Ω
 - Rated Output Level: -10 dB (at 10 k Ω load)
- These jacks output signals to be input to external signal processors.

40 POWER Switch

This switch turns the power supply to this unit on and off. Always make sure that the **STEREO fader** is set to "0" and the **MONITOR/PHONES** control is set to "MIN" when turning this unit on or off.

41 MONITOR OUT Jacks

- Output Impedance: 1 k Ω
 - Rated Output Level: -10 dB (at 10 k Ω load)
- The same signal which is output from the **PHONES** jack is also output from these jacks. They can be used for connecting a speaker with built-in amplifier, etc.

CAUTION (FOR CANADA MODEL)
TO PREVENT ELECTRIC SHOCK, MATCH WIDE BLADE OF PLUG TO WIDE SLOT, FULLY INSERT.

42 AC IN Socket

Connect the supplied power cord here.

43 STEREO OUT Jacks

- Output Impedance: 1 k Ω
 - Rated Output Level: -10 dB (at 10 k Ω load)
- For mixdown, connect these jacks to the stereo tape deck.

44 AUX RETURN 1 and 2 Jacks

- Input Impedance: 20 k Ω
 - Rated Input Level: -10 dB (AUX RTN LEVEL control nominal)
- These jacks input signals from external signal processors. These jacks are stereo jacks, so that a stereo signal processor with one input and two outputs can be connected. If using a signal processor with monaural output only, connect to the L (MONO) side of these jacks. If not using a signal processor, these jacks can be used as stereo input jacks.

45 2TR IN Jacks

- Input Impedance: 10 k Ω
 - Rated Input Level: -10 dB (MONITOR/PHONES control nominal)
- The signals can be monitored by way of this unit if the LINE OUT jacks of the tape deck are connected to these jacks and the **MONITOR SELECT** switch is set to **2TR IN**.

46 TAPE OUT Jacks (1-8/SYNC)

- Output Impedance: 100 Ω
 - Rated Output Level: -10 dB (at 10 k Ω load)
- The sounds for each track are output from these jacks directly. During playback, the sounds from the tracks being played back are output, and during recording, the sounds from the tracks being recorded are output. Adjustment of output levels from these jacks is not possible, so adjust the volume on the unit which is connected to the respective jacks. When performing SYNC recording, the SYNC signal is output from the **TAPE OUT 8/SYNC** jack.

RECORDING METHODS

The following methods are some of the basic functions on how to perform multi-track recording.

- **MONITOR:** Monitoring the status of recording or playback
- **INITIAL RECORDING:** Recording the first sound (part)
- **OVERDUBBING:** A method for recording a new track while monitoring previously recorded tracks.
- **PING-PONG RECORDING:** A method for recording mixed signals of several recorded tracks onto another track.
- **PUNCH-IN/OUT RECORDING:** A technique to re-record a short segment of an otherwise perfect track in order to correct a mistake or "brush up" an important passage.
- **SYNC RECORDING:** A method for recording sound from a MIDI device making it synchronized with the sound signal previously recorded on the tape.
- **MIXDOWN:** The final stage of recording to create the stereo master tape in which the signals of the tracks which have been created by multi-track recording are mixed.
- **RECORDING LEVEL SETTING:** A method for recording at the optimum level.

These are indispensable methods for using a multi-track recorder. So you must understand these methods well before starting actual multi-track recording. See "CONNECTION EXAMPLE" on page 40.

■ MONITOR

Various methods of monitoring are possible with this unit as described below. More than one of these monitoring methods can be used at the same time. Use whichever method works best for your purpose.

GROUP: This makes it possible to monitor signals just before they are sent to the recorder. If only one switch is pressed, monitoring will be monaural, and if both switches are pressed, monitoring will be in stereo (groups 1 and 3 for "L" and groups 2 and 4 for "R"). This allows you to check the signal just before it is recorded, to make sure it is the sound you want, and to listen for distortion and other problems.

STEREO: With this function, signals input to channels 1 to 8 of the mixer and to **AUX RETURN** jacks can be monitored in stereo. Because signals which have not been assigned to a group bus can also be monitored, this is convenient when recording while listening to other sound signals which are not being recorded. (For example, you could listen to rhythm guide sounds while recording, without the rhythm guide being recorded, or you could apply reverb to monitoring signals only if you are recording vocals, so that the reverb would not be recorded along with the other signals.)

When mixing-down, monitoring is basically done in this STEREO mode.

2TR IN: In this mode, signals input to the **2TR IN** jacks on the rear panel can be monitored. This is convenient when monitoring a stereo tape after it has undergone the final mixing, or when monitoring reference tapes and CDs.

Also, when mixing, if equalizing is being done between this unit and a stereo tape deck, the **2TR IN** jacks can be used to monitor the output from the stereo tape deck.

CUE: The recording/playback signals on each track can be monitored in the volume level set using the **CUE LEVEL** controls.

All monitoring will be in the monaural mode, however.

If the **REC SELECT** switch has been pressed to specify recording on a certain track and the corresponding **REC select indicator** (○) is lighted, recording signals can be monitored on that track. If the REC select indicator (○) for a certain track has gone out or is flashing, the playback signals can be monitored on that track.

This is a convenient feature which allows monitoring of playback signals without inputting the signals to the mixer.

It also allows recording signals to be balanced with recording/playback signals from other tracks during the monitoring process, without affecting the recording level.

Adjust the overall monitoring level using the **MONITOR/PHONES** control.

MONITOR
SELECT



GROUP



STEREO



2TR IN



CUE





■ INITIAL RECORDING



This is the initial recording process, before any recording has been done on any track.



PROCEDURE



① Getting ready to record

1. Set the **input selector** switch to the MIC/LINE (or LINE) position for the channel to which signals from an instrument or microphone are to be input, and adjust the input level using the **channel fader**. (See "SETTING THE RECORDING LEVELS" on page 28.)
2. Using the **ASSIGN** switches and the **PAN** control, select the group bus to which the input signals will be sent.

With   and  , the signals are sent to Group [1].

With   and  , the signals are sent to Group [2].

With   and  , the signals are sent to Group [3].

With   and  , the signals are sent to Group [4].

If the **PAN** control is set to a position partway between L/ODD and R/EVEN, input signals can be sent to odd-numbered and even-numbered tracks.

3. Press the **REC SELECT** switch for the group selected in step 2, to select the track to be recorded. The **REC** select indicator (○) on the display flashes.
4. Press the **MONITOR SELECT CUE** switch, and slide up the **CUE LEVEL** control for the track to be recorded.
5. Press the **REC/PAUSE** button. The **REC/PAUSE** indicator illuminates, and the **REC** select indicator (○) on the display illuminates.
6. Adjust the recording level using the corresponding **GROUP MASTER** control, while playing a phrase with high volume. (See "SETTING THE RECORDING LEVELS" on page 28.)
7. Adjust the **CUE LEVEL** as well as the **MONITOR/PHONES** control.
8. Press the **COUNTER RESET** button and reset the tape counter to "00:00".

② Recording

9. Press the **PLAY** button to start recording. The **PLAY** indicator illuminates. At the same time, play the instrument including counts.
10. When playing is finished, press the **RTZ** button to stop and rewind the tape. (It is also good idea to use the **LOC 1** or **2** buttons to locate a memory point.) The **PLAY** and **REC/PAUSE** indicators go out, and the **REC** select indicator (○) flashes.

③ Checking the finished recording

11. Press the **PLAY** button to play back the tape, and check the contents of the recording.
12. If the recording needs to be redone, press the **REC/PAUSE** button once again (The **REC/PAUSE** indicator illuminates), and repeat steps (9-11).

* Various other methods of monitoring recordings are available, in addition to those described above. Use whichever method works best for your purpose. (See "Monitor" on page 14.)

OVERDUBBING

Overdubbing is the process of recording a new track/s while monitoring previously recorded tracks. By this method, you can easily record a sound playing in exact timing with other sounds already-recorded. This method is convenient for composing music by playing several instruments by yourself, or when all players cannot meet together.

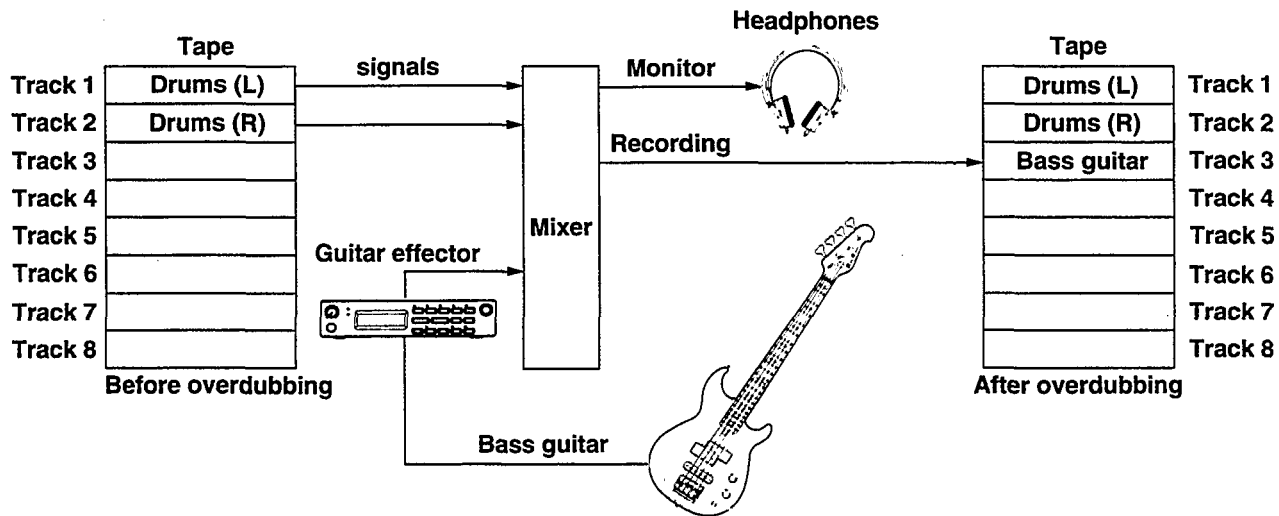

PROCEDURE

Getting ready to record

1. Set the input selector switch to the MIC/LINE (or LINE) position for the channel to which signals from an instrument or microphone are to be input.
Adjust the input level using the corresponding channel fader.
2. Select the group bus to which the input signals will be sent using the **ASSIGN** switches and the **PAN** control.
3. Select the track on which the signals are to be recorded using the **REC SELECT** switch. The corresponding REC select indicator (○) flashes.
4. Press the **CUE** button under **MONITOR SELECT**.
5. Set the **CUE LEVEL** control for the tracks to be played back to 7 - 8.
6. Press the **REHE** button. The **REHE** indicator illuminates and the **REC** select indicator on the display illuminates.
7. While playing an instrument, adjust the recording level using the corresponding **GROUP MASTER** control.
8. Press the **COUNTER RESET** button.

Rehearsal

9. Press the **PLAY** button to start rehearsal (a pseudo-recording). The **PLAY** indicator illuminates.
10. Play an instrument while listening to sounds of the track being played back, and adjust the **CUE LEVEL** controls for the recording track and the track being played back.
If the pitch between the playback sound and the sound you are actually playing does not match, adjust it using the **PITCH** control.
11. Press the **RTZ** button to finish the rehearsal and rewind the tape.

* PITCH CONTROL

Sometimes the pitch of an instrument and the pitch of the already-recorded signals on tape differ. In this case, you can compensate for the pitch of the recorded signals with the **PITCH** control. If the **PITCH** control switch is pressed to enter into the FIX mode (the green indicator illuminates), the tape speed is set to 9.5 cm/sec. and cannot be changed. If the switch is pressed to enter into the VARI mode (the red indicator illuminates) and then the dial is turned, the tape speed can be varied within a range of approximately $\pm 12\%$. The tape speeds at the center position in the VARI mode and in the FIX mode are not necessarily the same. When you do not wish to change the tape speed, set the **PITCH** control switch to the FIX mode. Never change the setting from VARI to FIX or vice versa while the tape is running.

○ Recording

12. Press the **REC/PAUSE** button. The **REC/PAUSE** indicator flashes.
13. Press the **PLAY** button to start recording. The **PLAY** indicator illuminate.
14. At the same time, play the instrument while listening to sounds of the track being played back.
15. When recording is finished, press the **RTZ** button to stop and rewind the tape.
The **PLAY** and **REC/PAUSE** indicators go out and the **REC** select indicator(○) on the display flashes.

○ Checking the finished recording

16. Press the **PLAY** button to play back the tape and check the contents of the recording.
17. If the recording needs to be redone, repeat steps (12-16).

* Various other methods of monitoring are available, in addition to those described above. Use whichever method works best for your purpose. (See "Monitor" on page 14.)

■ PING-PONG RECORDING

The recorder of this unit is provided with 8 tracks, so it is possible to use the overdubbing method to record up to 8 different parts with no problem. However, if you want to make a multi-track recording of more than 8 parts, it is impossible with the overdubbing method. Ping-pong recording is a technique often used to overcome such a problem. For instance, if the recorded signals on tracks 1-4 are mixed and re-recorded onto other 2 tracks (tracks 5 and 6 for example), tracks 1-4 can be used for new recording.

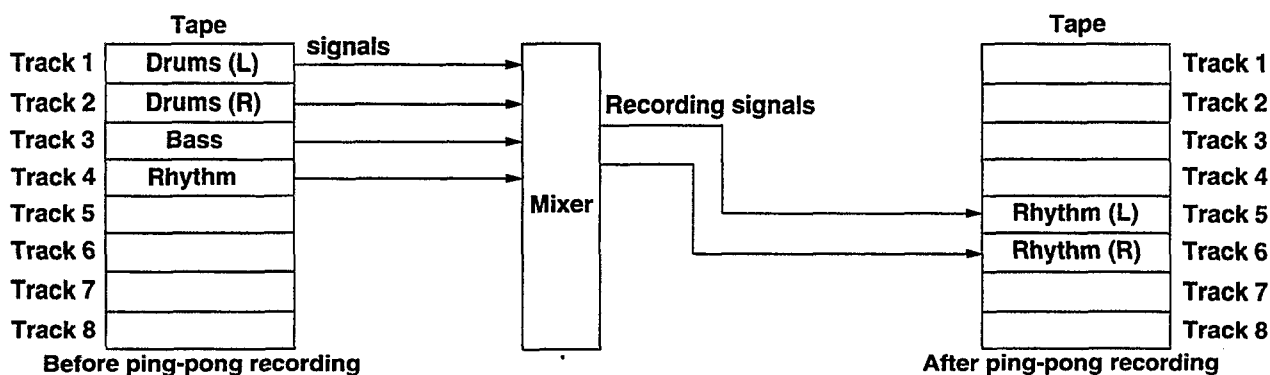

PROCEDURE

○ Getting ready to record

1. Set the **input selector** switches to the **TAPE** position for the channels which correspond to the tracks whose signals will be "mixed". (Channels 1-4 for the example figured above)
2. Use the **ASSIGN** switches and the **PAN** control to select the group bus to which input signals will be sent, and to adjust the orientation of the signals.
3. Press the **REC SELECT** switch for the track on which a ping-pong recording will be made. The corresponding **REC** select indicator flashes.
4. Turn on the group bus selected in step 2 for the **MONITOR SELECT** switch.
(If you will perform a ping-pong recording in stereo like the example figured above, press both the **GROUP** switches so that you can monitor recording signals in stereo.)
5. Press the **REHE** button. The **REHE** indicator illuminates and the **REC** select indicator(○) on the display illuminates.
6. Set the corresponding **GROUP MASTER** controls at about 7-8.
7. Press the **COUNTER RESET** button.

○ Rehearsal

8. Press the **PLAY** button to start the rehearsal. The **PLAY** and **REHE** indicators illuminate.
9. Adjust the **channel fader**, **PAN** control and **equalizer controls** for each channel. If necessary, add an effect and adjust its level for each channel.
10. Adjust the recording level using the corresponding **GROUP MASTER** controls. (See "MONITOR" on page 14.)
11. Press the **RTZ** button to finish the rehearsal and rewind the tape.

○ Recording

12. Press the **REC/PAUSE** button. The **REC/PAUSE** indicator illuminates.
13. Press the **PLAY** button to start recording. The **PLAY** indicator illuminates.
14. When recording is finished, press the **RTZ** button to stop and rewind the tape. The **PLAY** and **REC/PAUSE** indicators go out and the **REC** select indicator (Ⓞ) on the display flashes.

○ Checking the finished recording

<For monaural ping-pong recording>

15. Release the **GROUP** switch under **MONITOR SELECT** and press **CUE**.
16. Slide up the **CUE LEVEL** control for the recorded track.
17. Press the **PLAY** button to play back the tape, and check the contents of the recording.
18. If the recording needs to be redone, repeat steps 4-17.

<For stereo ping-pong recording>

15. Release the **GROUP** switch under **MONITOR SELECT** and press **STEREO**.
16. Set the **input selector** switches to the **TAPE** position for the channels which correspond to the recorded tracks, and set the **channel faders** at about 7-8. (Channels 5 and 6 for the example.)
Also, adjust the orientation of signals by using the **PAN** controls. (Set the channel 5 to "L" and channel 6 to "R" for the example.)
17. Set the **input selector** switches (which were set to the **TAPE** position in step 1) to the **MIC/LINE** (or **LINE**) position.
18. Press the **PLAY** button to play back the tape, and check the contents of the recording.
19. If the recording needs to be redone, first set the **input selector** switches (which were set to the **TAPE** position in step 16) to the **MIC/LINE** (or **LINE**) position, secondly, set the **input selector** switches (which were set to the **MIC/LINE** (or **LINE**) position in step 17) to the **TAPE** position, and then repeat the procedures in steps 4-18.

Notes

- Be careful not to record the tape playback signals input to a channel onto a track which has the same number with the channel. This will cause an oscillation.
- Various other methods of monitoring recordings are available, in addition to those described above. Be careful not to monitor the playback signals on tracks and the signals made by mixing (ping-ponging) them at the same time, otherwise monitoring cannot be done properly.
- The overuse of ping-pong recording may deteriorate audio sound quality. Ping-pong recording a recorded sound should not be carried out repeatedly.
- Ping-pong recording onto adjacent tracks within the same block of the record/playback head should be avoided. This can cause audio signal oscillation.

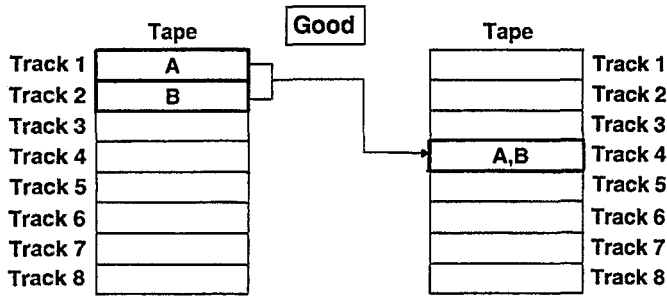

(Ping-ponging to a track other than an adjacent one is good.)

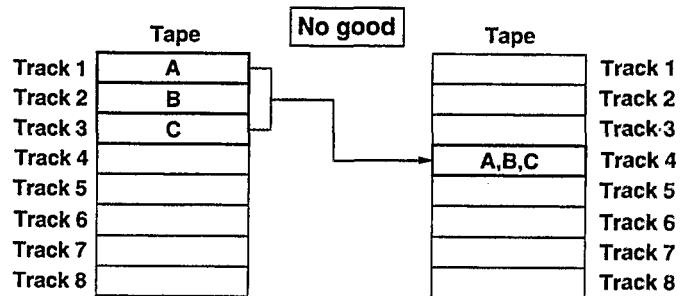

(Ping-ponging to an adjacent track is not good.)

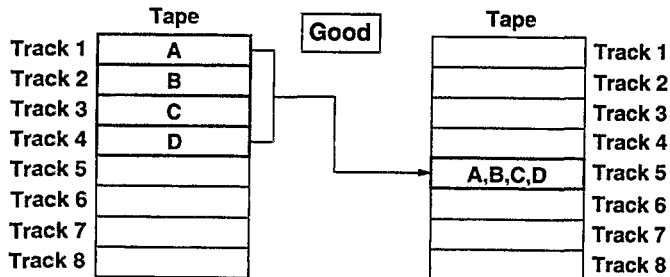

(Ping-ponging from track 4 to track 5 is permissible, and vice versa, though they adjoin.)

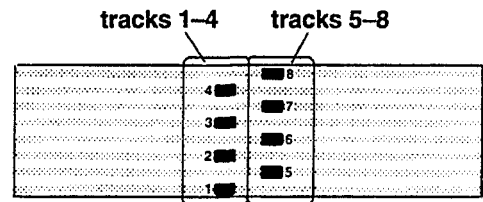

The structure of the record/playback head

■ PUNCH-IN/OUT RECORDING

Punch-in/out recording is a technique for re-recording a short segment of a track which has already been recorded. Once the tape has been played back as far as the segment to be re-recorded, switch the track to recording mode (punch-in), record the new segment, and then once the re-recording is completed, switch the track back to play mode (punch-out).

In doing punch-in/out recording, it is necessary to allow blank spaces on the track, approximately 0.5 seconds or more before and after the segment to be re-recorded.

Re-recording is made onto the whole segment between the two blank spaces.

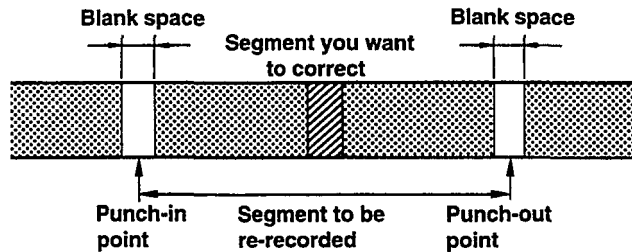

Punch-in/out recording methods can be broadly divided into the following four methods.

1. Punch-in/out using the REC/PAUSE button and the PLAY button
2. Punch-in/out using the REC SELECT switches
3. Punch-in/out using the footswitch (sold separately)
4. Punch-in/out using the automatic punch-in/out function

1. Punch-in/out using the REC/PAUSE button and the PLAY button

1. Select the track on which the punch-in/out recording is to be carried out using the **REC SELECT** switch.
2. Press the **PLAY** button to play back the tape, and start playing an instrument.
3. Press the **REC/PAUSE** button at the punch-in location. The **REC/PAUSE** indicator illuminates and recording begins (punch-in).
4. Press the **PLAY** button at the punch-out location. The **REC/PAUSE** indicator goes out and recording stops (punch-out).

2. Punch-in/out using the REC SELECT switches

1. Check to be sure that no track has been selected for recording.
2. Press the **REC/PAUSE** button. The **REC/PAUSE** indicator flashes rapidly.
3. Press the **PLAY** button to play back the tape, and start playing an instrument.
4. At the punch-in location, press the **REC SELECT** switch for the track to be re-recorded. The **REC select** indicator on the display and the **REC/PAUSE** indicator illuminate and recording begins (punch-in).
* When pressing more than one **REC SELECT** switch, do not press them simultaneously, instead press them one after another.
5. At the punch-out location, press the same **REC SELECT** switch once again. Recording stops (punch-out).

3. Punch-in/out using the footswitch (sold separately)

- * Before operations, connect the footswitch (FC04 or FC05) to the **PUNCH I/O** jack on the front panel of this unit.
1. Select a track on which the punch-in/out recording is to be carried out using the **REC SELECT** switch.
 2. Press the **REC/PAUSE** button. The **REC/PAUSE** indicator illuminates.
 3. Depress the footswitch to play back the tape, and start playing an instrument. The **REC/PAUSE** indicator flashes rapidly and the **PLAY** indicator illuminates.
 4. At the punch-in location, depress the footswitch. The **REC/PAUSE** indicator illuminates and recording starts (punch-in).
 5. At the punch-out location, depress the foot switch. The **REC/PAUSE** indicator goes out and recording stops (punch-out).

4. Punch-in/out using the automatic punch-in/out function

The automatic punch-in/out function differs from the three punch-in/out methods described in the previous section in that, once the punch-in and punch-out points have been specified, punch-in and punch-out are then carried out automatically.

1. Selecting the track.

Select the track on which the punch-in/out is to be carried out using the **REC SELECT** switch.

2. Specifying the following working points

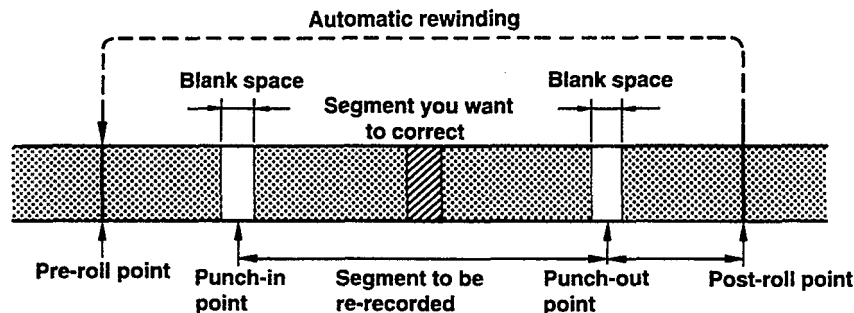

- Pre-roll point (at which the punch-in/out operation begins)
- Punch-in point (at which the recording begins)
- Punch-out point (at which the recording ends)
- Post-roll point (at which the punch-in/out operation ends)

2-1 Specify the pre-roll point using the **AUTO PUNCH I/O** switch. A location two to four measures before the punch-in point usually works well for the pre-roll point.

2-2 Press the **PLAY** button (or the footswitch) to play back the tape. It is possible to reverse the order of steps 2-1 and 2-2.

2-3 While monitoring the tape, press the **REC/PAUSE** switch (or the footswitch) to specify the punch-in point.

2-4 While monitoring the tape, press the **PLAY** button (or the footswitch) to specify the punch-out point.

When the punch-out point is specified, a location five seconds later is automatically assigned as the post-roll point.

When the tape reaches the post-roll point, it is rewound automatically back to the pre-roll point.

The **REHE** indicator begins to flash rapidly when this unit is switched into "rehearsal-standby" mode.

* Correcting the point setting

● To correct a punch-in/out point setting, press **CLEAR** and start again from step 2.

● To correct a pre-roll point, press the **AUTO PUNCH I/O** switch to cancel the automatic punch-in/out function and start again from step 1.

3. Rehearsal

When the punch-in/out points have been specified, you can proceed with a "rehearsal", or practice the changes to be made.

The "rehearsal" is to perform a pseudo-recording, which means that the same movements will occur as if the tape were being recorded, but actual recording will not be carried out.

It is good for you to adjust the level and establish the timing in pseudo-recording.

3-1 Press the **GROUP** button under **MONITOR SELECT** and press the **PLAY** button (or the footswitch) to playback the audio signal from the tape to be monitored.

3-2 Press the **PLAY** button to play back the tape, and play the part to be re-recorded at the same time.

When the tape reaches the punch-in point, the [IN] on the display illuminates, along with the **REHE** indicator.

This indicates that pseudo-recording has just begun, and the monitored sound is switched from the playback sounds to the sound you are actually playing.

When the tape reaches the punch-out point, [OUT] on the display illuminates and the **REHE** indicator goes off, and the tape returns to playback mode, with the monitored sound also switching back from the live sound to the playback sound.

As the tape reaches the post-roll point [out] on the display goes off, and the tape is rewound back to the pre-roll point automatically and this unit is turned into the "rehearsal-standby" mode. Pressing the **PLAY** button will start the rehearsal again, so you can repeat this "rehearsal" many times until you are satisfied.

If you need to rehearse no more, do not press the **PLAY** button and go on to the next step "actual recording".

4. Carrying out the automatic punch-in/out function

4-1 Press the **REC/PAUSE** button.

The **REHE** indicator goes out and the **REC/PAUSE** indicator flashes rapidly.

4-2 Press the **PLAY** button to play back the tape, and play the part to be re-recorded at the same time.

As the tape reaches the punch-in point, the mode switches to the recording mode, and as the tape reaches the punch-out point, the mode goes back to the playback mode.

As the tape reaches the post-roll point, the tape is rewound back to the pre-roll point.

5. Checking the finished punch-in/out recording

5-1 Press the **PLAY** button again to play back the tape.

Monitoring the re-recorded tape, make sure it has been recorded properly.

5-2 Proceed to the following step according to the result.

- **If the result is good:**

Press the **AUTO PUNCH I/O** switch to cancel the automatic punch-in/out function.

Pressing this switch clears the punch-in and punch-out points, as well as the pre-roll and post-roll points.

If you will carry out punch-in/out recording on another part, you must begin from selecting the track or setting the punch-in/out points, etc.

- **If the result is not good:**

Press the **REHE** button and re-operate from step 3 "Rehearsal" again.

If the point setting is not correct, press the **AUTO PUNCH I/O** switch to cancel this function and re-operate from step 2-1.

● Checking the current status using the indicators

The current status can be monitored while the automatic punch-in/out function is in use, by checking the **AUTO PUNCH I/O**, the **REHE**, and the **REC/PAUSE** indicators.

Status Indicated by indicators

AUTO PUNCH I/O	REHE	REC/PAUSE	Status
Flashing	Flashing	off	Only the pre-roll point have been specified. (2-1)
Illuminating	Flashing rapidly	off	Pseudo-recording (rehearsal) starts by pressing the PLAY button. (3-2)
Illuminating	off	Flashing rapidly	Punch-in/out recording starts by pressing the PLAY button. (4-2)
Illuminating	off	off	The result of punch-in/out recording can be check by pressing the PLAY button. (5-1)

■ SYNC RECORDING

Normally, to dub over a previously-recorded segment you play a new part along with the previous recording, matching the tempo of it. There is no problem with this method to overdub something like a vocal or guitar part, but a different technique is required with MIDI instruments (such as synthesizers and rhythm machines).

To overdub with MIDI instruments, it is necessary to supply a "SYNC signal" which is the same information as the tempo of the previously-recorded part with a format that can be decoded by the MIDI instrument. The technique to overdub with MIDI instruments using the SYNC signal is the "SYNC recording".

The following two units of equipment are needed in order to carry out SYNC recording on this unit:

MIDI instrument: Any equipment that inputs and/or outputs SYNC signals which contain the data of "tempo", such as a music sequencer or a rhythm machine.

MIDI converter: SYNC signals output from MIDI instruments have an extremely high frequency and cannot be used for recording without being converted to signals called FSK (Frequency Shift Keying). A MIDI converter such as the YAMAHA YMC 10 can be used for this type of signal conversion. Some MIDI instruments can output the FSK signals, in which case an external MIDI converter is not necessary. Please read the instruction manual provided with your MIDI instrument to see if it outputs the FSK signals.

● Recording FSK Signals

1. Connections

(Fig. 1) When using a MIDI instrument which cannot output FSK signals

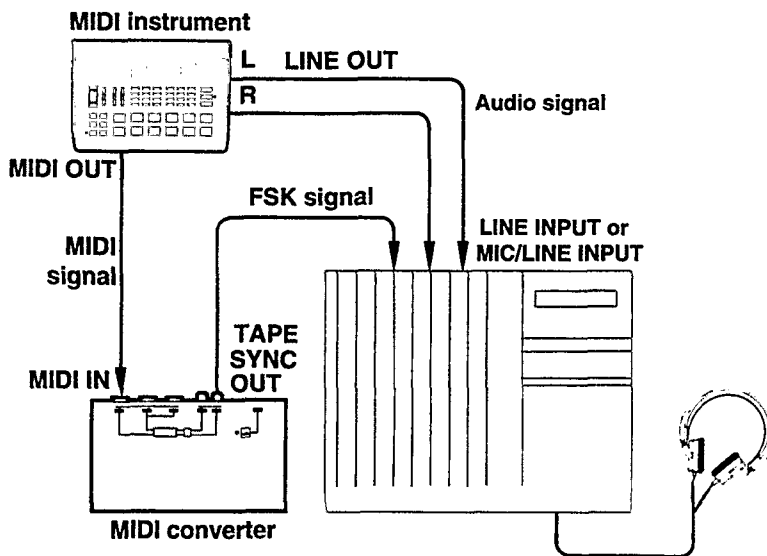

(Fig. 2) When using a MIDI instrument which can output FSK signals

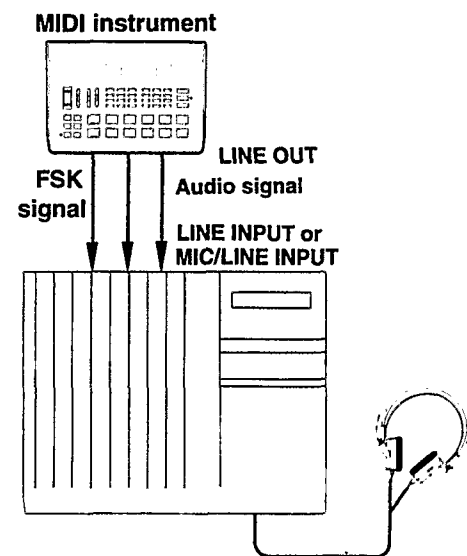

Record FSK signals on track 8.

This instrument is equipped with the **dbx** noise reduction system. Leaving the **dbx** system on, however, can interfere with the recording of FSK signals or cause other problems, and may also interfere with synchronization.

This instrument is designed so that, when the **SYNC** switch is pressed to be turned on, the **dbx** function is turned off for track 8 only. Therefore, if performing SYNC recording with the **dbx** function left on, record the Audio signals on tracks 1 to 7, and the FSK signals on track 8.

If the **dbx** switch is turned off, the FSK signals can be recorded on any track.

2. Recording procedure

Turn the power on to the MIDI instrument, MIDI converter and this unit according to the order.

Settings for the mixer channel

1. Set both the **equalizer HIGH, MIO** and **LOW** controls to "0".
2. Set both the **AUX 1** and 2 controls to "0".
3. Set the **ASSIGN** switch to select [3] and [4].
4. Set the **PAN/BAL** control to "R/EVEN".
5. Set the **input selector** switch to the "LINE" position.
6. Set the **channel fader** at 7-8.

Settings on the MASTER section of the mixer and the recorder

7. Set the **GROUP MASTER GROUP 4** control at 7-8.
8. Press the **STEREO** switch under **MONITOR SELECT** and set the stereo fader to between 7-8.
9. Using the **REC SELECT** switches, select track 8.
10. To use dbx, press the **SYNC** switch. The **SYNC** indicator illuminates on the display.

Preparing to record sound signals

11. To record audio signals output from a MIDI instrument, set the mixer channels for recording to any track and set the **GROUP MASTER** fader to 7 - 8.
(See "Initial recording" on page 15.)

Rehearsal

12. Press the **REHE** button to turn this unit into the "rehearsal" mode, and start the performance on the MIDI instrument.
13. Adjust the recording level using the **GROUP MASTER** control while watching the level meter. Adjust the recording level of FSK signals so that the level meter indicates about +6 dB.
14. Adjust the monitoring level by using the **MONITOR/PHONES** control.
15. Stop the MIDI instrument.

Recording

16. Insert the cassette tape, and press the **COUNTER RESET** button.
17. Press the **REC/PAUSE** button, and then press the **PLAY** button.
18. Start the performance on the MIDI instrument, and monitor the sound.
Make the performance on MIDI instrument from the beginning to the end of the program thoroughly. By this performance, the Start, Tempo and End signals are memorized.
19. When the performance is finished, press the **RTZ** button to rewind back the tape.

● Recording by synchronized performance

Playback the FSK signals recorded on track 8 and synchronize them with MIDI instruments and record their sound.

1. Connections

(Fig. 1) Connection example when using a MIDI instrument which cannot output FSK signals

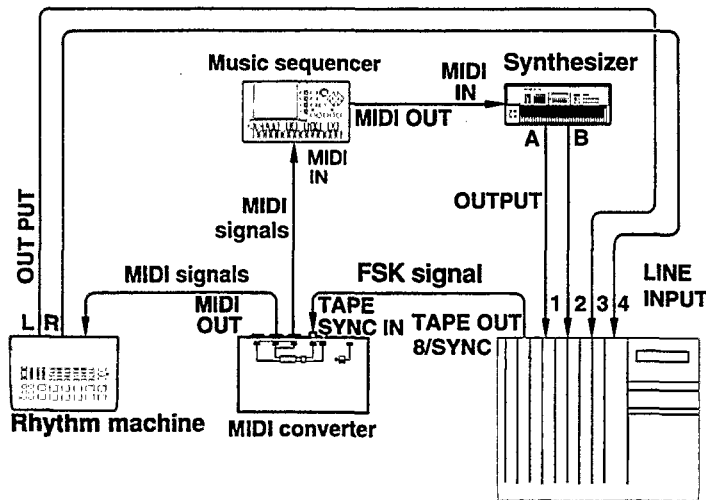

(Fig. 2) Connection example when using a MIDI instrument which can output FSK signals

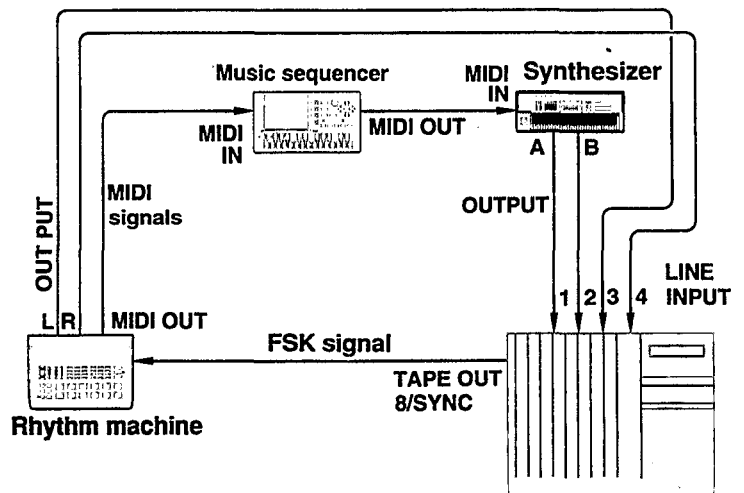

2. Recording Procedure

- **Turning the power on**
 1. Turn the power on to the MIDI converter, rhythm machine, music sequencer, synthesizer and this unit according to the order.
- **Preparing MIDI instruments**
 2. Set the MIDI instrument to MIDI clock mode, to receive MIDI signals from the MIDI converter.
 3. Set the MIDI instrument to FSK sync mode, to receive FSK signals.
 4. Prepare the song data etc. to start recording immediately.
- **Setting for channels of the mixer**
 5. Set the controls and switches for channels that input the audio signals from the MIDI instrument. (See "Initial recording" on page 15.)
- **Settings on the MASTER section of the mixer and the recorder**
 6. Set **GROUP MASTER** controls to 7 - 8, this affects only the tracks the audio signals will be recorded to.
 7. Press the **GROUP** switch under **MONITOR SELECT**.
 8. Select the recording tracks using the **REC SELECT** switches.
 9. To use **dbx**, press the **SYNC** switch. The **SYNC** indicator illuminates on the display.

Rehearsal

10. Rewind the tape to just before the beginning of the recorded FSK signals and press the **COUNTER RESET** button.
11. Press the **REHE** button to turn this unit into the "rehearsal" mode, and press the **PLAY** button to start tape playback.
The performance on the MIDI instrument begins by being synchronized with the FSK signals recorded on track 8.
* Be sure to play back the tape from the point before the FSK signal begins. If not so, the MIDI instrument will not work properly.
12. Adjust the recording level using the **GROUP MASTER** controls and the **channel faders**. (See "SETTING THE RECORDING LEVELS" on page 28.)
13. Adjust the monitoring level using the **MONITOR/PHONES** control.
14. When the performance is finished, press the **RTZ** button to finish the rehearsal and rewind the tape.

Recording

15. Press the **REC/PAUSE** button and then press the **PLAY** button.
SYNC recording is carried out automatically.
16. When the recording is finished, press the **RTZ** button to rewind the tape.

Checking the finished SYNC recording

17. Press the **PLAY** button to play back the tape. Monitoring the recorded tape, make sure it has been recorded properly.
18. Press the **CUE** switch under **MONITOR SELECT** and slide up the **CUE LEVEL** faders for the tracks originally recorded.
19. If the recording needs to be redone, adjust some controls if necessary, and start re-recording.

3. Mixdown using SYNC recording

For synchronized performance at the mixdown stage with this unit, audio signals from MIDI instruments are not recorded. This enables a higher quality of mixdown, while taking full advantage of the number of recording tracks. At mixdown, output the FSK signals on track 8 from the **TAPE OUT 8/SYNC** jack to make the MIDI instrument perform. At the same time, input the resulting output signals from the MIDI instrument to the channel 8 in stereo format and mix down with signals from other seven tracks.

Connection example

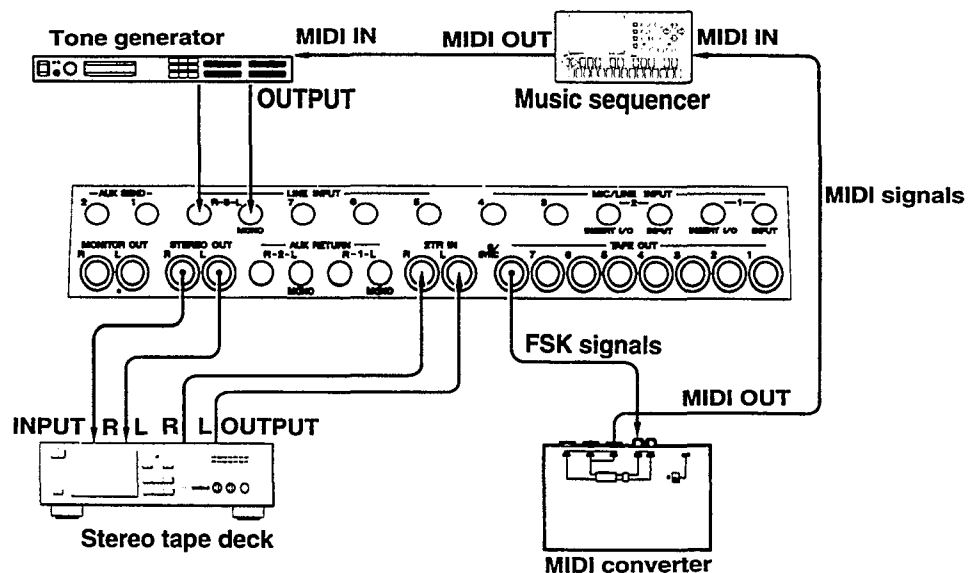

■ MIXDOWN

Mixdown is the final stage in the recording process at which time you can blend and polish the sounds to create the final product.

A "Mix" is created by finely balancing the eight tracks to achieve just the right sound. This final balance is achieved using this mixer section and is re-recorded onto a conventional stereo tape deck. Tracks can be faded in or out as required, and refinements such as overall reverberation or equalization can be added using external signal processor and the built-in equalizer of this unit. The mixer's **PAN** controls can be used to position each track at their appropriate location in the stereo image, and you may even want to move or "pan" a sound from one channel to the other to create a dramatic effect.

● CONNECTIONS

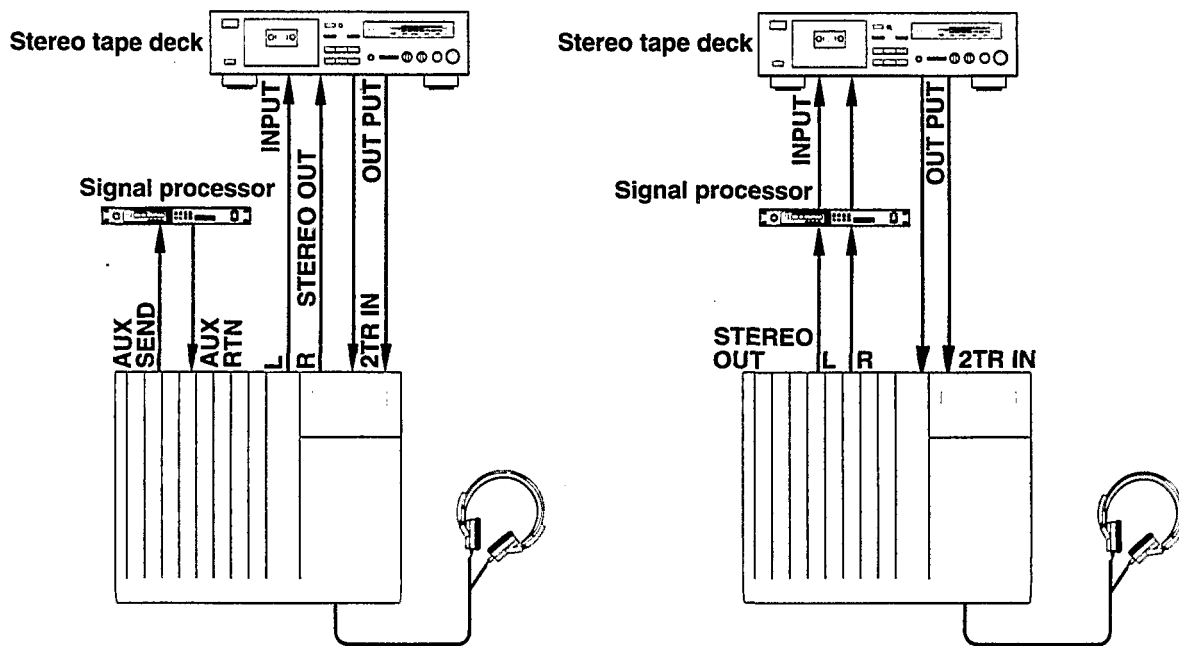

● RECORDING PROCEDURE

○ Getting ready to record

1. Set the **input selector** switches to the **TAPE** position for the channels which correspond to the numbers of the already-recorded tracks.
2. Press the **STEREO** button under **MONITOR SELECT**.
3. Play back the tape and adjust the playback level for each channel. Also adjust the **PAN** controls, equalizer controls and **AUX** controls.
Adjust the recording level of the stereo tape deck at the same time.

○ Recording

4. Start recording on the stereo tape deck, and then press the **PLAY** button of this unit. The tape is played back, and the sound is recorded to the stereo tape deck.
When starting recording, it is good idea to cut out any counts recorded on a track.

To cut out counts recorded on track 1, for example;

Set the input selector switch for channel 1 to the **MIC/LINE** position. Slide up the **CUE LEVEL** fader for track 1 and press the **CUE** button under **MONITOR SELECT**.

Start recording, and when the counts have been completed, immediately set the input selector switch for channel 1 to the **TAPE** position. Then deselect the **CUE** button under **MONITOR SELECT**.

○ Checking the finished mixdown

5. When recording is finished, rewind the master tape in the tape deck and play back it.
By changing the **MONITOR SELECT** switch from **STEREO** to **2TR IN**, you can monitor mixed-down signals (or audio signals just before mix-down) with headphones.
- * If you will use a graphic equalizer or compressor connected between this unit's **STEREO OUT** jacks and the tape deck, you had better monitor sound signals with the **MONITOR SELECT 2TR IN** switch "on" from the step of "Getting ready to record".

■ SETTING THE RECORDING LEVELS

Setting optimum recording levels is vitally important to obtain the best possible recording quality. If the level is too low, tape noise will be more noticeable, and if the level is too high, the sound will become distorted. Thus, the recording level should ideally be set to the highest level at which distortion does not occur. This unit is equipped with level meters which indicate the peak values of the levels for each track and the stereo signal levels. In addition, a complete range of monitoring is possible by the use of the **MONITOR SELECT GROUP** (1,3/2,4), **STEREO**, **2TR IN** and **CUE** switches. Use the level meters in conjunction with the various monitoring functions to set the recording level. (See "Monitor" on page 14.)

About the level meters

If a level meter display goes over the normal limit for a very short instant, this is not a sign of a problem. The reason is because human ears can hardly detect distortion which lasts for only a short period of time. However, if the level meter display is over the normal limit all the time, you must decrease the level.

○ Procedure

1. Set the **channel faders** to a nominal value of 7 to 8.
2. Adjust the **GAIN** controls so that the **CLIP** indicators light momentarily.
3. Select any tracks using the **REC SELECT** switches and press the **REC/PAUSE** button to adjust the **GROUP MASTER** controls.
 - When **dbx** is off, set the level so that the level meter occasionally illuminates at the +3 dB mark.
 - When **dbx** is on, set the level so that the level meter occasionally illuminates at the +9 dB mark.
4. Turn on **CUE** and set the **CUE LEVEL** fader of the recording track at the optimum value of 7 - 8. While monitoring the sound of each instrument, adjust the level balance between channels using the channel faders.
5. If the recording level is varied by the influence of the adjustment in step 4, re-adjust the level using the **GROUP MASTER** controls.
6. Repeat steps 4 and 5 alternately.

RECORDING EXAMPLES

This section gives the following two basic recording examples.

Example 1 : A basic recording (overdubbing)

Example 2: An advanced recording with Ping-pong recording and SYNC-recording techniques

There are important steps before starting recording. Those are to construct a "recording plan" and to "set recording levels" properly. So, before describing how to make recording by using examples, we will first elaborate on the "recording plan" and "setting recording levels".

RECORDING PLAN

Before starting multi-track recording, it's important to construct an overall working plan.

It is recommended that you put together a plan that takes into account factors such as the organization of the instruments, the overall structure of the program, the parts that you wish to emphasize, the final stereo orientation and so on. If you go ahead with multi-track recording without making such a plan, you may encounter problems such as running out of tracks, limits in orienting of the sound image, etc. These problems may increase the number of ping-pong recordings, which at the end will result in a poor quality.

Procedure

1. Determine the organization of instruments and their respective positions.

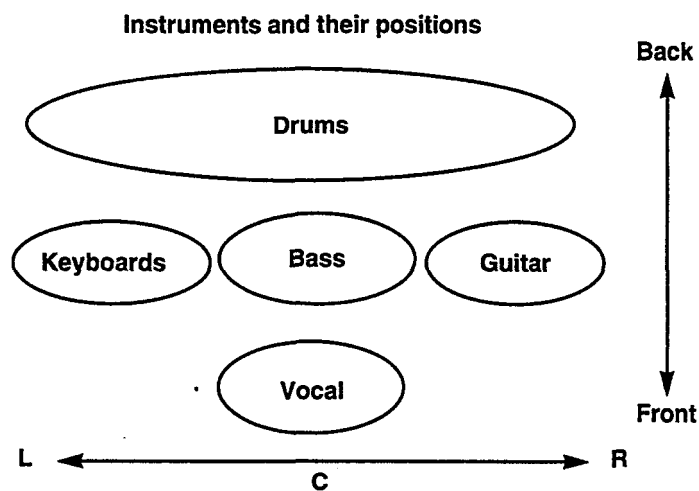

2. Determine the final designation of each track

Example:

- Track 1Drums L
- Track 2.....Drums R
- Track 3.....Bass Guitar
- Track 4.....Vocal
- Track 5.....Guitar Backing
- Track 6.....Guitar Solo
- Track 7.....Keyboards

3. Determine the recording order.

The flow of an ordinary recording is as follows.

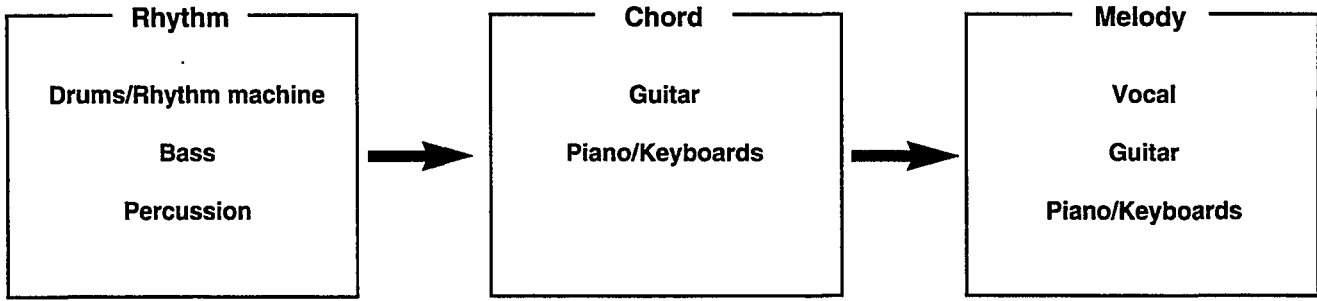

The detailed plan is made based on this flow. Drawing up a detailed plan covering all elements, for example the mixer channel assignment, sound image orientation and effects, simplifies the recording operations.

4. Use the attached PLANNING SHEET

A planning sheet is included with this operation manual. This sheet is very useful when actually creating a recording plan or while recording is in progress.

MIXER									
CH	1	2	3	4	5	6	7	8	
INPUT	T M/L	T M/L	T M/L	T M/L	T L	T L	T L	T L	
SOURCE									
MIC TRAC	1 2 3 4	1 2 3 4	1 2 3 4	1 2 3 4	1 2 3 4	1 2 3 4	1 2 3 4	1 2 3 4	
ASSIGN	00 01 02 03	04 05 06 07	08 09 10 11	12 13 14 15	16 17 18 19	20 21 22 23	24 25 26 27	28 29 30 31	
PAN	☉	☉	☉	☉	☉	☉	☉	☉	
AUX	1 2	1 2	1 2	1 2	1 2	1 2	1 2	1 2	
EFFECT									
ASSIGN	1 2	3 4	1 2	3 4					
LEVEL	☉	☉							

RECORDER			
SOURCE			
TRACK	1	2	3
GROUP	1	2	3
TRACK	5	6	7
SOURCE			

TITLE/STEP _____ / _____
 PROCESS _____
 NOTE _____
 PLANNING SHEET _____ DATE _____

- CH:** Mixer channels 1-8.
- INPUT:** T = TAPE, M/L = MIC/LINE, L = LINE
- SOURCE:** Enter the sources (the instruments) to be recorded.
- REC TRACK:** Indicate recording tracks 1-8.
- ASSIGN:** Indicate the setting of **ASSIGN** switches (combination of bus lines for signal output).
- PAN:** Indicate the positions of the **PAN** controls.
- AUX:** Indicate the **AUX 1** and **2** control positions (level of output to the **AUX SEND** jacks).
- EFFECT:** Enter the types of effects and their descriptions.
- LEVEL:** Indicate the **AUX RTN LEVEL** control positions (level of input from **AUX RETURN** jacks).

■ RECORDING EXAMPLE 1: A basic recording (overdubbing)

As a basic recording, let's take the three rhythm instruments and the melody, which make up the underlying structure of the music, and put them together.

○ Recording plan

1. Determine the organization of instruments and the position of each instrument as figured on the right.

2. Determine the final designation of each track.

- Track 1Drums L
- Track 2Drums R
- Track 3Bass Guitar
- Track 4Vocal
- Track 5Guitar Backing
- Track 6Guitar Solo

3. Determine the recording order

○ The order of an ordinary recording is as follows.

1. **Rhythm parts:** Rhythm Machine (as Drums)
Bass Guitar
2. **Backing part:** Guitar Backing
3. **Melody parts:** Vocal
Guitar Solo

Instruments and their respective positions

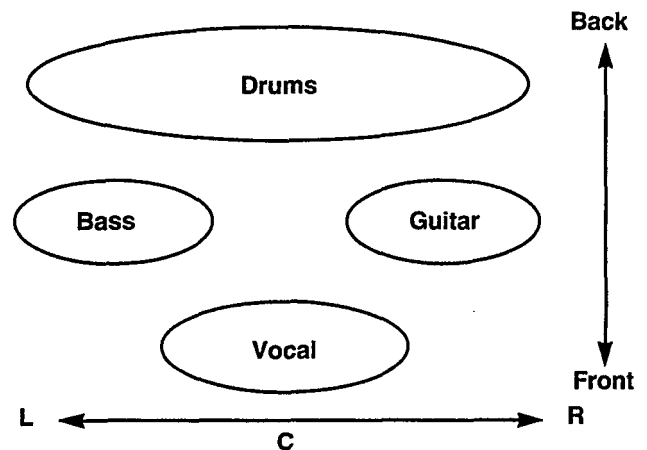

● Recording procedure

1. Recording the rhythm parts

Record the drum part performed by the rhythm machine onto tracks 1 and 2 in stereo.

At this time, it is recommended to record counts on a few measures before the beginning of the program.

Next, play the bass guitar while listening to the recorded drum part (or at the same time as recording the drum part), and record this bass part onto track 3.

If you think it will be difficult to play the bass without listening to vocals, you may record temporary vocals onto another track (such as track 8), and play the bass while listening to the recorded vocals and drum part.

2. Recording the chord backing

While listening to the rhythm parts which have been recorded, play the guitar and record the backing part onto track 5.

3. Recording the vocal part

While listening to the rhythm and backing parts which have been recorded, record the vocal part onto track 4.

4. Recording the Guitar Solo

While listening to the rhythm, backing and vocal parts which have been recorded, play the guitar and record the guitar solos such as the lead-in and interlude onto track 6.

5. Mixdown

Adjust the level balance and tone for the signals recorded in steps 1-4, and the orientation of instruments in the stereo image, and also apply effects to them as required. After that, mix down the signals to the stereo tape deck.

○ Making Planning Sheets

1. Recording the Rhythm Parts

MIXER								
CH	1	2	3	4	5	6	7	8
INPUT	T ML	T ML	T ML	T ML	T L	T L	T L	T L
SOURCE			Bass		Drms L	Drms R		
ASSIGN	1	2	3	4	5	6	7	8
PAN	0	0	0	0	0	0	0	0
AUX	1	2	3	4	5	6	7	8
EFFECT								
ASSIGN	1,2	3,4	1,2	3,4				
LEVEL	0	0						
TITLE/STEP								/1
PROCESS	Rhythm							
NOTE								
DATE								
PLANNING SHEET								

RECORDER			
SOURCE	Drms L	Drms R	Bass
TRACK	1	2	3
GROUP	5	6	7
TRACK	5	6	7
SOURCE			

2 Recording the Chord Backing

MIXER								
CH	1	2	3	4	5	6	7	8
INPUT	T ML	T ML	T ML	T ML	T L	T L	T L	T L
SOURCE		E.Gtr						
ASSIGN	1	2	3	4	5	6	7	8
PAN	0	0	0	0	0	0	0	0
AUX	1	2	3	4	5	6	7	8
EFFECT								
ASSIGN	1,2	3,4	1,2	3,4				
LEVEL	0	0						
TITLE/STEP								/2
PROCESS	Backing							
NOTE								
DATE								
PLANNING SHEET								

RECORDER			
SOURCE	Drms L	Drms R	Bass
TRACK	1	2	3
GROUP	5	6	7
TRACK	5	6	7
SOURCE	Gtr		

3 Recording the Vocal

MIXER								
CH	1	2	3	4	5	6	7	8
INPUT	T ML	T ML	T ML	T ML	T L	T L	T L	T L
SOURCE	Vcl.							
ASSIGN	1	2	3	4	5	6	7	8
PAN	0	0	0	0	0	0	0	0
AUX	1	2	3	4	5	6	7	8
EFFECT	VOCAL REV							
ASSIGN	1,2	3,4	1,2	3,4				
LEVEL	0	0						
TITLE/STEP								/3
PROCESS	Vocal							
NOTE								
DATE								
PLANNING SHEET								

RECORDER				
SOURCE	Drms L	Drms R	Bass	Vcl.
TRACK	1	2	3	4
GROUP	5	6	7	8
TRACK	5	6	7	8
SOURCE	Gtr			

* Reverberation is applied to monitoring signals, however, recording will be done without reverberation.

4 Recording the Guitar Solo

MIXER								
CH	1	2	3	4	5	6	7	8
INPUT	T ML	T ML	T ML	T ML	T L	T L	T L	T L
SOURCE		E.Gtr						
ASSIGN	1	2	3	4	5	6	7	8
PAN	0	0	0	0	0	0	0	0
AUX	1	2	3	4	5	6	7	8
EFFECT								
ASSIGN	1,2	3,4	1,2	3,4				
LEVEL	0	0						
TITLE/STEP								/4
PROCESS	Guitar Solo							
NOTE								
DATE								
PLANNING SHEET								

RECORDER				
SOURCE	Drms L	Drms R	Bass	Vcl.
TRACK	1	2	3	4
GROUP	5	6	7	8
TRACK	5	6	7	8
SOURCE	Gtr	Gtr solo		

5 Mixdown

MIXER								
CH	1	2	3	4	5	6	7	8
INPUT	T ML	T ML	T ML	T ML	T L	T L	T L	T L
SOURCE	Drms L	Drms R	Bass	Vcl.	Gtr	Gtr solo		
ASSIGN	1	2	3	4	5	6	7	8
PAN	0	0	0	0	0	0	0	0
AUX	1	2	3	4	5	6	7	8
EFFECT	VOCAL REV	ROOM REV						
ASSIGN	1,2	3,4	1,2	3,4				
LEVEL	0	0						
TITLE/STEP								/5
PROCESS	Mixdown							
NOTE								
DATE								
PLANNING SHEET								

RECORDER				
SOURCE	Drms L	Drms R	Bass	Vcl.
TRACK	1	2	3	4
GROUP	5	6	7	8
TRACK	5	6	7	8
SOURCE	Gtr	Gtr solo		

● Connections/Operations

1. Connections

Make connections as figured on the right. Before connections, be sure to turn OFF the power to all equipments.

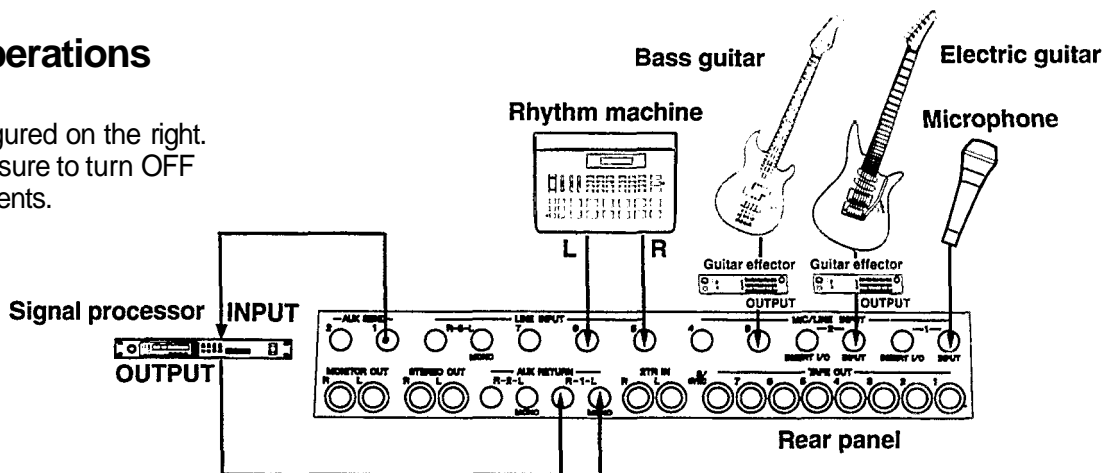

2. Turning the power ON/Setting the tape

Set the all output level controls to minimum, and turn the power ON to the rhythm machine and then to this unit. At this time, leave all controls or faders set to "0" or "MIN".

Insert a tape into the cassette compartment and run the tape forward. Stop the tape after about 20 seconds, and press the **COUNTER RESET** button to reset the tape counter to "00:00".

3. Recording the Rhythm Parts

Setting the controls and switches on the mixer

By following the contents of the PLANNING SHEET, set them for channels 3, 5 and 6 as follows. Be sure to set the **channel faders** for other channels to "0".

Set faders 1, 2 and 3 for the **CUE LEVEL** controls at 7 - 8.

		Channel 3	Channel 5	Channel 6
GAIN control		LINE	LINE	LINE
Equalizer control	H I G H	0	0	0
	M I D	0	0	0
	L O W	0	0	0
AUX control	A U X 1	0	0	0
	A U X 2	0	0	0
ASSIGN switch	1 / 2	off	ON	ON
	3 / 4	ON	off	off
PAN control		L/ODD	L/ODD	R/EVEN
Input selector switch		MIC/LINE	LINE	LINE
Channel fader		7-8	7-8	7-8

Setting the controls and switches on the MASTER section

Set the **AUX RTN ASSIGN** switches to off, and the **MASTER fader** to "0".

GROUPMASTER control	GROUP 1	7-8
	GROUP 2	7-8
	GROUP 3	7-8
	GROUP 4	0
MONITOR SELECT switch	GROUP 1/3	off
	GROUP 2/4	off
	STEREO	off
	2TR IN	off
	CUE	ON
MONITOR/PHONES control		Center

● **Playing the instruments/Recording**

1. By following the contents of the PLANNING SHEET, select tracks (1, 2 and 3) on which recording will be made using the **REC SELECT** switches.
The **REC** select indicators 1, 2 and 3 on the display flashes.
2. Press the **REC/PAUSE** button to turn this unit into the recording standby mode. The **REC/PAUSE** indicator flashes.
3. Adjust the recording level.
Start the performance on the rhythm machine. Monitoring the sound of the rhythm machine, play the bass guitar. Adjust the **GROUP MMMASTER** controls so that the level meters for tracks 1, 2 and 3 illuminate at the +9 dB mark momentarily at the maximum volume level. When the adjustment is finished, stop the rhythm machine.
4. Press the **PLAY** button to start recording on tracks 1, 2 and 3.
Start the performance on the rhythm machine and play the bass guitar. When the performance is finished, press the **RTZ** button to stop recording and to rewind the tape back to the start point.
5. Play back the tape to check the finished recording.
If the recording has succeeded, proceed to the next step. If the recording or the performance has not succeeded, make re-recording or punch-in/out recording as required.

4. Recording the Chord Backing

Record the guitar backing on track 5 repeating the procedure of step 3, "Recording the Rhythm Parts".
Set the mixer as shown in step 2 of the "Recording plan" on page 32.
Set the fader for channel 2 to 7 - 8 and reset the fader for channels 3, 5, and 6 to "0".
Set fader 5 for the **CUE LEVEL** controls at 7 - 8.

5. Recording the Vocal

Record vocals using the microphone connected to channel 1, by repeating the procedures in step 3 "Recording the Rhythm Parts". However, please note the following two differences:
One is that the **GAIN** control for channel 1 should to be adjusted at the "MIC" side. (See "SETTING THE RECORDING LEVELS" on page 28.)
The other is that reverberation is applied to monitoring signals of the vocal. However, reverberation will not be applied to the recording signals.

- * For reverberations;
Set the **AUX 1** control for channel 1 to 5 (center position).
Set **AUX RTN ASSIGN** switches [1] [2] to off and [3] [4] to off.
Set the **STEREO** switch under **MONITOR SELECT** to ON.

6. Recording the Guitar Solo

The procedure is the same with that of step 3, "Recording the Rhythm Parts."

■ RECORDING EXAMPLE 2: An advanced recording

Let's try an advanced multi-track recording with ping-ponging many music parts and attempting a SYNC recording of MIDI instruments.

○ Recording plan

1. Determine the organization of instruments and the position of each instrument as figured below.

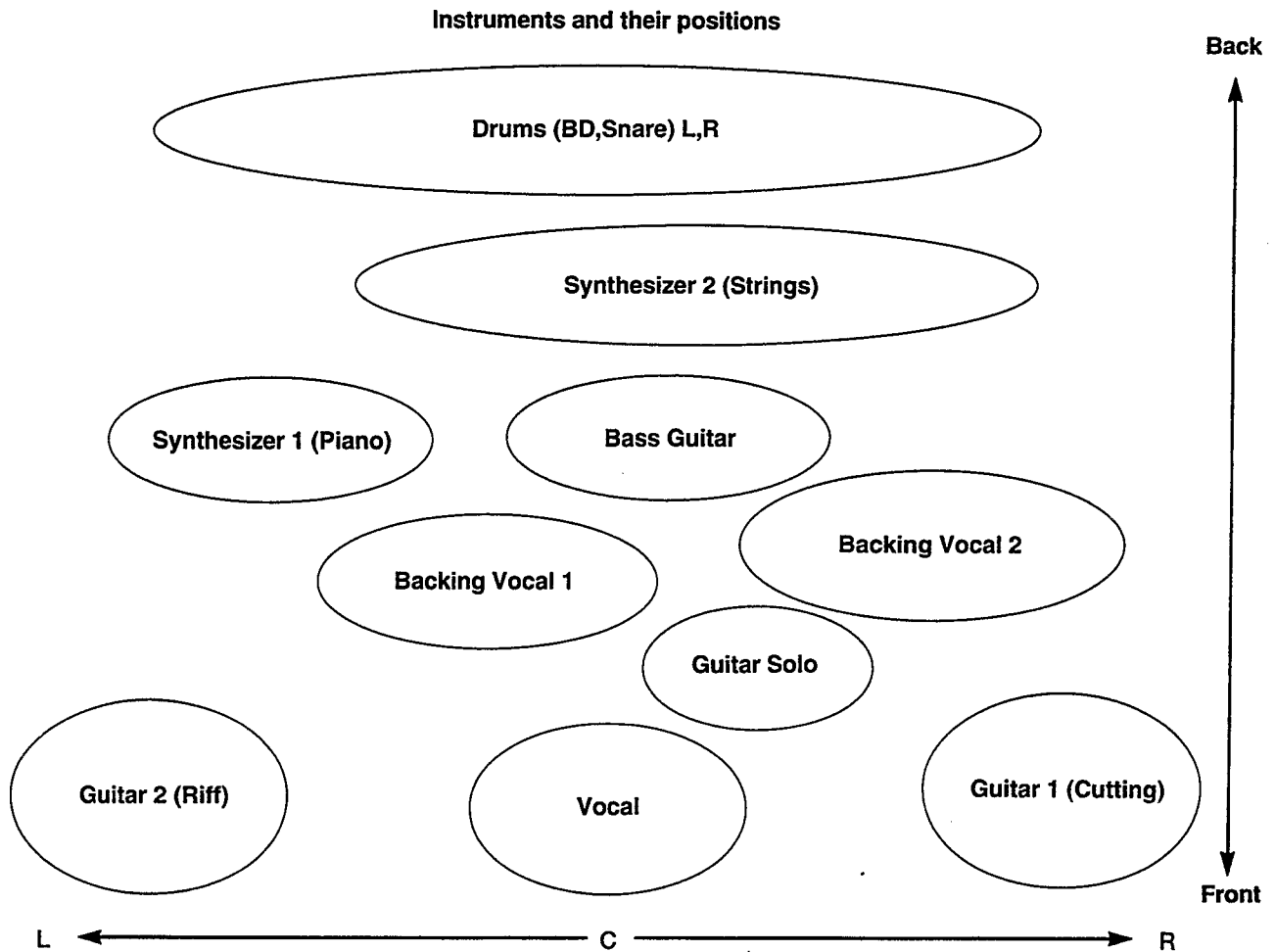

2. Determine the final designation of each track.

- | | | |
|---------------|-----------------|-------|
| Track 1 | Guitar Solo | |
| Track 2 | Vocal | |
| Track 3 | Backing (L) | _____ |
| Track 4 | Backing (R) | _____ |
| Track 5 | Rhythm (L) | _____ |
| Track 6 | Rhythm (R) | _____ |
| Track 7 | Backing Vocal 1 | |
| Track 8 | Backing Vocal 2 | |
- _____ ——— Guitar 2 (Riff), Synthesizer 2 (Strings)
 _____ ——— Drums, Bass Guitar, Guitar 1 (Cutting),
 _____ ——— Synthesizer 1 (Piano)

● Recording procedure

1. Recording the Drum, Bass parts and SYNC signals (Initial recording)

While recording the drum and bass parts, record the FSK signal onto track 8.

- 1) Play back the rhythm machine (drum part) and record the sound signals onto tracks 1 and 2.
Output the sounds of the bass drum and snare drum separately, add some appropriate effects to each of them respectively, and mix them together.
- 2) Simultaneously, synchronize the music sequencer with the SYNC signal to play the synthesizer (bass part), and record the sound signals onto track 3.
- 3) Simultaneously, record the FSK signal to track 8 through the MIDI converter.

2. Recording the Guitar 1 (Cutting)

While listening to the recorded drum and bass parts, play the guitar and record the sound signals to track 4 as the Guitar 1 (Cutting) part.

3. Ping-pong the rhythm parts (with SYNC recording of Synthesizer 1)

Mix the synchronized rhythm part (by Synthesizer 1) with the rhythm parts that have been already-recorded, and then ping-pong the mix in stereo.

- 1) Synchronize the music sequencer with the SYNC signal which has been recorded onto track 8 (as FSK signal), and play the Synthesizer 1 part.
- 2) Play back tracks 1-4 and mix each part with the Synthesizer 1 part (while adjusting the volume balance and orientation, and adding effects), and record the mixed stereo signals onto tracks 5 and 6.

4. Recording the Guitar 2 (Backing)

While listening to the rhythm parts on tracks 5 and 6, play the guitar and record the sound signals to track 1 as the Guitar 2 part (which is to be the riff part).

5. Ping-ponging the backing parts

Mix the recorded Guitar 2 part with the Synthesizer 2 part (the sound of the strings), and then ping-pong the mix of them in stereo.

- 1) Synchronize the music sequencer with the SYNC (FSK) signal which has been recorded onto track 8, and then play the Synthesizer 2 part.
- 2) Play back track 1, and mix the Guitar 2 part on track 1 with the Synthesizer 2 part (while adjusting the volume balance and orientation, and adding effects), and record the mixed stereo signals onto tracks 3 and 4.

6. Recording the Lead Vocal part

- 1) Change the **GAIN** control for channel 1 from the "LINE" side to the "MIC" side, and adjust the input level.
- 2) While listening to the rhythm parts on tracks 5 and 6 and the backing parts on tracks 3 and 4, sing and record this singing to track 2 as the Lead Vocal part.

7. Recording the Backing vocal 1 part

While listening to the rhythm parts on tracks 5 and 6, the backing parts on tracks 3 and 4 and the lead vocal part on track 2, sing a vocal backing and record this singing to track 7 as the backing vocal 1 part.

8. Recording the Backing vocal 2 part

While listening to the rhythm parts on tracks 5 and 6, the backing parts on tracks 3 and 4, the lead vocal part on track 2 and the backing vocal 1 part on track 7, sing another vocal backing and record this singing to track 8 as the backing vocal 2 part. (Because there will be no more SYNC recording after this, it doesn't matter if the FSK signal on track 8 is erased.)

9. Recording the Guitar Solo part

While listening to the rhythm, backing, lead vocal and backing vocals, play the guitar and record it to track 1 as the guitar solo part.

10. Mixdown

Mixdown of signals recorded on all tracks.

The sound orientation of the guitar solo part and the backing vocal parts should be done in this step.

Making Planning Sheets

1. Recording the rhythm parts

MIXER									
CH	1	2	3	4	5	6	7	8	
INPUT	T ML	T ML	T (ML)	T (ML)	T L	T L	T L	T L	
SOURCE			Drms BD	Drms SD	Drms L	Drms R	Sync Sig	Synth	
REC. TRACK	1 2 3 4	1 2 3 4	1 2 3 4	1 2 3 4	1 2 3 4	1 2 3 4	1 2 3 4	1 2 3 4	
ASSIGN	1 2 3 4	1 2 3 4	1 2 3 4	1 2 3 4	1 2 3 4	1 2 3 4	1 2 3 4	1 2 3 4	
PAN	0 100	0 100	0 100	0 100	0 100	0 100	0 100	0 100	
AUX	1 2 3 4	1 2 3 4	1 2 3 4	1 2 3 4	1 2 3 4	1 2 3 4	1 2 3 4	1 2 3 4	
EFFECT	ROOM REV	GATE REV							
ASSIGN	1 2 3 4	1 2 3 4							
LEVEL	0 100	0 100							
TITLE/STEP	Rhythm <u>1</u>								
PROCESS	Rhythm								
NOTE									
PLANNING SHEET	DATE								

RECORDER			
SOURCE	Drms L	Drms R	Bass
TRACK	1	2	3
GROUP	1	2	3
TRACK	5	6	7
SOURCE			Sync Sig

2. Recording the Guitar 1 (Cutting)

MIXER									
CH	1	2	3	4	5	6	7	8	
INPUT	T ML	T (ML)	T ML	T ML	T L	T L	T L	T L	
SOURCE		E.Gtr							
REC. TRACK	1 2 3 4	1 2 3 4	1 2 3 4	1 2 3 4	1 2 3 4	1 2 3 4	1 2 3 4	1 2 3 4	
ASSIGN	1 2 3 4	1 2 3 4	1 2 3 4	1 2 3 4	1 2 3 4	1 2 3 4	1 2 3 4	1 2 3 4	
PAN	0 100	0 100	0 100	0 100	0 100	0 100	0 100	0 100	
AUX	1 2 3 4	1 2 3 4	1 2 3 4	1 2 3 4	1 2 3 4	1 2 3 4	1 2 3 4	1 2 3 4	
EFFECT									
ASSIGN	1 2 3 4	1 2 3 4							
LEVEL	0 100	0 100							
TITLE/STEP	Cutting <u>2</u>								
PROCESS	Cutting								
NOTE									
PLANNING SHEET	DATE								

RECORDER			
SOURCE	Drms L	Drms R	Bass
TRACK	1	2	3
GROUP	1	2	3
TRACK	5	6	7
SOURCE			Sync Sig

3 Ping-pong the rhythm parts

MIXER									
CH	1	2	3	4	5	6	7	8	
INPUT	T ML	T ML	T ML	T ML	T L	T L	T L	T L	
SOURCE	Drms L	Drms R	Bass	Gtr 1				Synth L,R	
REC. TRACK	1 2 3 4	1 2 3 4	1 2 3 4	1 2 3 4	1 2 3 4	1 2 3 4	1 2 3 4	1 2 3 4	
ASSIGN	1 2 3 4	1 2 3 4	1 2 3 4	1 2 3 4	1 2 3 4	1 2 3 4	1 2 3 4	1 2 3 4	
PAN	0 100	0 100	0 100	0 100	0 100	0 100	0 100	0 100	
AUX	1 2 3 4	1 2 3 4	1 2 3 4	1 2 3 4	1 2 3 4	1 2 3 4	1 2 3 4	1 2 3 4	
EFFECT	ROOM REV	DELAY							
ASSIGN	1 2 3 4	1 2 3 4							
LEVEL	0 100	0 100							
TITLE/STEP	Ping-pong the rhythm parts <u>3</u>								
PROCESS	Ping-pong the rhythm parts								
NOTE									
PLANNING SHEET	DATE								

RECORDER			
SOURCE	Drms L	Drms R	Bass
TRACK	1	2	3
GROUP	1	2	3
TRACK	5	6	7
SOURCE	Rytm L	Rytm R	Sync Sig

4 Recording the Guitar 2 (Backing)

MIXER									
CH	1	2	3	4	5	6	7	8	
INPUT	T ML	T (ML)	T ML	T ML	T L	T L	T L	T L	
SOURCE		E.Gtr							
REC. TRACK	1 2 3 4	1 2 3 4	1 2 3 4	1 2 3 4	1 2 3 4	1 2 3 4	1 2 3 4	1 2 3 4	
ASSIGN	1 2 3 4	1 2 3 4	1 2 3 4	1 2 3 4	1 2 3 4	1 2 3 4	1 2 3 4	1 2 3 4	
PAN	0 100	0 100	0 100	0 100	0 100	0 100	0 100	0 100	
AUX	1 2 3 4	1 2 3 4	1 2 3 4	1 2 3 4	1 2 3 4	1 2 3 4	1 2 3 4	1 2 3 4	
EFFECT									
ASSIGN	1 2 3 4	1 2 3 4							
LEVEL	0 100	0 100							
TITLE/STEP	Backing <u>4</u>								
PROCESS	Backing								
NOTE									
PLANNING SHEET	DATE								

RECORDER			
SOURCE	Gtr 2	Drms R	Bass
TRACK	1	2	3
GROUP	1	2	3
TRACK	5	6	7
SOURCE	Rytm L	Rytm R	Sync Sig

5 Ping-ponging the backing part

MIKER								
CH	1	2	3	4	5	6	7	8
INPUT	T ML	T ML	T ML	T ML	T L	T L	T L	T L
SOURCE	Gtr 2							Synth L,R
MIC TRACK	1 2 3 4	1 2 3 4	1 2 3 4	1 2 3 4	1 2 3 4	1 2 3 4	1 2 3 4	1 2 3 4
ASSIGN	00 00	00 00	00 00	00 00	00 00	00 00	00 00	00 00
PAN	[Pan knobs]							
AUX	[Aux knobs]							
EFFECT	ROOM REV	DELAY						
ASSIGN	1 2 3 4	1 2 3 4						
LEVEL	[Level knobs]							
TITLE/STEP	5							
PROCESS	Ping-pong the backing part							
NOTE								
PLANNING SHEET	DATE -- --							

RECORDER				
SOURCE	1	2	3	4
Gtr 2	1	2	3	4
Drms R	5	6	7	8
Synth L				
Synth R				
Rytm L				
Rytm R				
Sync Sig				

6 Recording the Lead Vocal part

MIKER								
CH	1	2	3	4	5	6	7	8
INPUT	T ML	T ML	T ML	T ML	T L	T L	T L	T L
SOURCE	Vcl.							
MIC TRACK	1 2 3 4	1 2 3 4	1 2 3 4	1 2 3 4	1 2 3 4	1 2 3 4	1 2 3 4	1 2 3 4
ASSIGN	00 00	00 00	00 00	00 00	00 00	00 00	00 00	00 00
PAN	[Pan knobs]							
AUX	[Aux knobs]							
EFFECT	VOCAL REV							
ASSIGN	1 2 3 4	1 2 3 4						
LEVEL	[Level knobs]							
TITLE/STEP	6							
PROCESS	Vocal							
NOTE								
PLANNING SHEET	DATE -- --							

RECORDER				
SOURCE	1	2	3	4
Gtr 2	1	2	3	4
Vcl.	5	6	7	8
Synth L				
Synth R				
Rytm L				
Rytm R				
Sync Sig				

7 Recording the Backing vocal part 1

MIKER								
CH	1	2	3	4	5	6	7	8
INPUT	T ML	T ML	T ML	T ML	T L	T L	T L	T L
SOURCE	Cho 1							
MIC TRACK	1 2 3 4	1 2 3 4	1 2 3 4	1 2 3 4	1 2 3 4	1 2 3 4	1 2 3 4	1 2 3 4
ASSIGN	00 00	00 00	00 00	00 00	00 00	00 00	00 00	00 00
PAN	[Pan knobs]							
AUX	[Aux knobs]							
EFFECT	VOCAL REV							
ASSIGN	1 2 3 4	1 2 3 4						
LEVEL	[Level knobs]							
TITLE/STEP	7							
PROCESS	Chorus 1							
NOTE								
PLANNING SHEET	DATE -- --							

RECORDER				
SOURCE	1	2	3	4
Gtr 2	1	2	3	4
Vcl.	5	6	7	8
Synth L				
Synth R				
Rytm L				
Rytm R				
Cho 1				
Sync Sig				

8 Recording the Backing vocal part 2

MIKER								
CH	1	2	3	4	5	6	7	8
INPUT	T ML	T ML	T ML	T ML	T L	T L	T L	T L
SOURCE	Cho 2							
MIC TRACK	1 2 3 4	1 2 3 4	1 2 3 4	1 2 3 4	1 2 3 4	1 2 3 4	1 2 3 4	1 2 3 4
ASSIGN	00 00	00 00	00 00	00 00	00 00	00 00	00 00	00 00
PAN	[Pan knobs]							
AUX	[Aux knobs]							
EFFECT	VOCAL REV							
ASSIGN	1 2 3 4	1 2 3 4						
LEVEL	[Level knobs]							
TITLE/STEP	8							
PROCESS	Chorus 2							
NOTE								
PLANNING SHEET	DATE -- --							

RECORDER				
SOURCE	1	2	3	4
Gtr 2	1	2	3	4
Vcl.	5	6	7	8
Synth L				
Synth R				
Rytm L				
Rytm R				
Cho 1				
Cho 2				

9 Recording the Guitar Solo part

MIKER								
CH	1	2	3	4	5	6	7	8
INPUT	T ML	T ML	T ML	T ML	T L	T L	T L	T L
SOURCE	Gtr solo							
MIC TRACK	1 2 3 4	1 2 3 4	1 2 3 4	1 2 3 4	1 2 3 4	1 2 3 4	1 2 3 4	1 2 3 4
ASSIGN	00 00	00 00	00 00	00 00	00 00	00 00	00 00	00 00
PAN	[Pan knobs]							
AUX	[Aux knobs]							
EFFECT								
ASSIGN	1 2 3 4	1 2 3 4						
LEVEL	[Level knobs]							
TITLE/STEP	9							
PROCESS	Guitar Solo							
NOTE								
PLANNING SHEET	DATE -- --							

RECORDER				
SOURCE	1	2	3	4
Gtr solo	1	2	3	4
Vcl.	5	6	7	8
Synth L				
Synth R				
Rytm L				
Rytm R				
Cho 1				
Cho 2				

10 Mixdown

MIKER								
CH	1	2	3	4	5	6	7	8
INPUT	T ML	T ML	T ML	T ML	T L	T L	T L	T L
SOURCE	Gtr solo	Vcl.	Synth L	Synth R	Rytm L	Rytm R	Cho 1	Cho 2
MIC TRACK	1 2 3 4	1 2 3 4	1 2 3 4	1 2 3 4	1 2 3 4	1 2 3 4	1 2 3 4	1 2 3 4
ASSIGN	00 00	00 00	00 00	00 00	00 00	00 00	00 00	00 00
PAN	[Pan knobs]							
AUX	[Aux knobs]							
EFFECT								
ASSIGN	1 2 3 4	1 2 3 4	1 2 3 4	1 2 3 4				
LEVEL	[Level knobs]							
TITLE/STEP	10							
PROCESS	Mixdown							
NOTE								
PLANNING SHEET	DATE -- --							

RECORDER				
SOURCE	1	2	3	4
	1	2	3	4
	5	6	7	8
Rytm L				
Rytm R				

○ Connections

Make connections as figured below. Be sure to turn OFF the power to all equipments before making any connection.

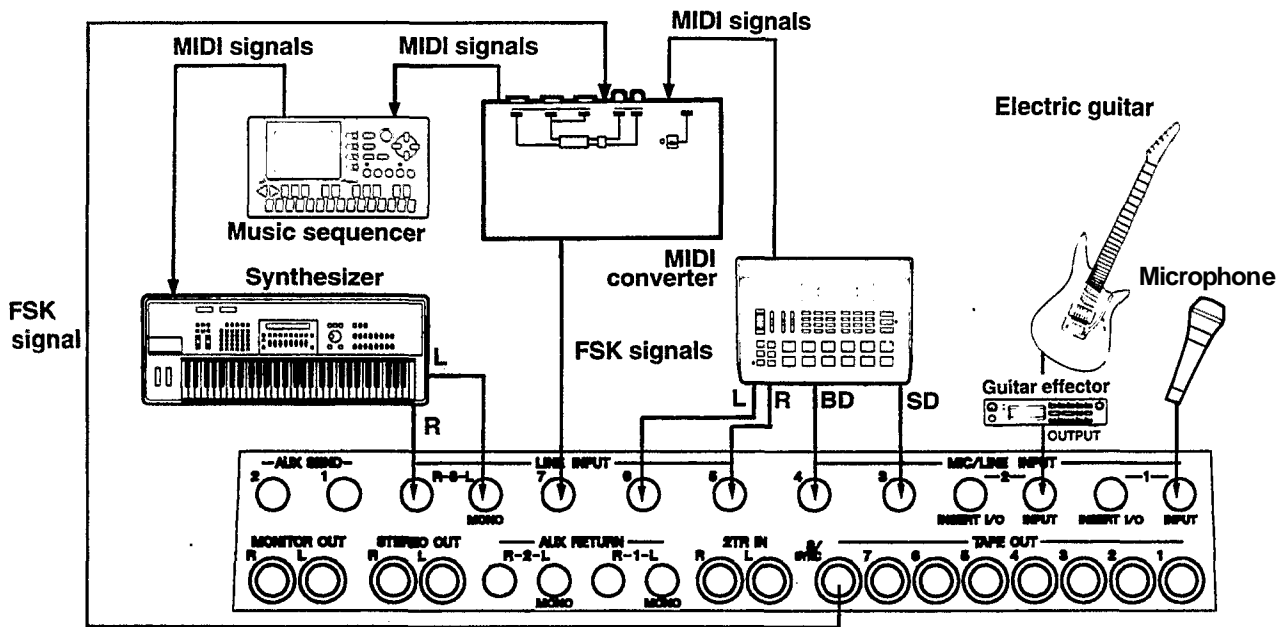

○ Operations

- Refer to the operations of "RECORDING EXAMPLE 1: A basic recording (overdubbing)".
- For setting controls and switches on this unit, follow the contents of the Planning sheets.
- For the operating method of ping-pong recording, see pages 17.
For the operating method of SYNC recording, see pages 23.

CONNECTION EXAMPLE

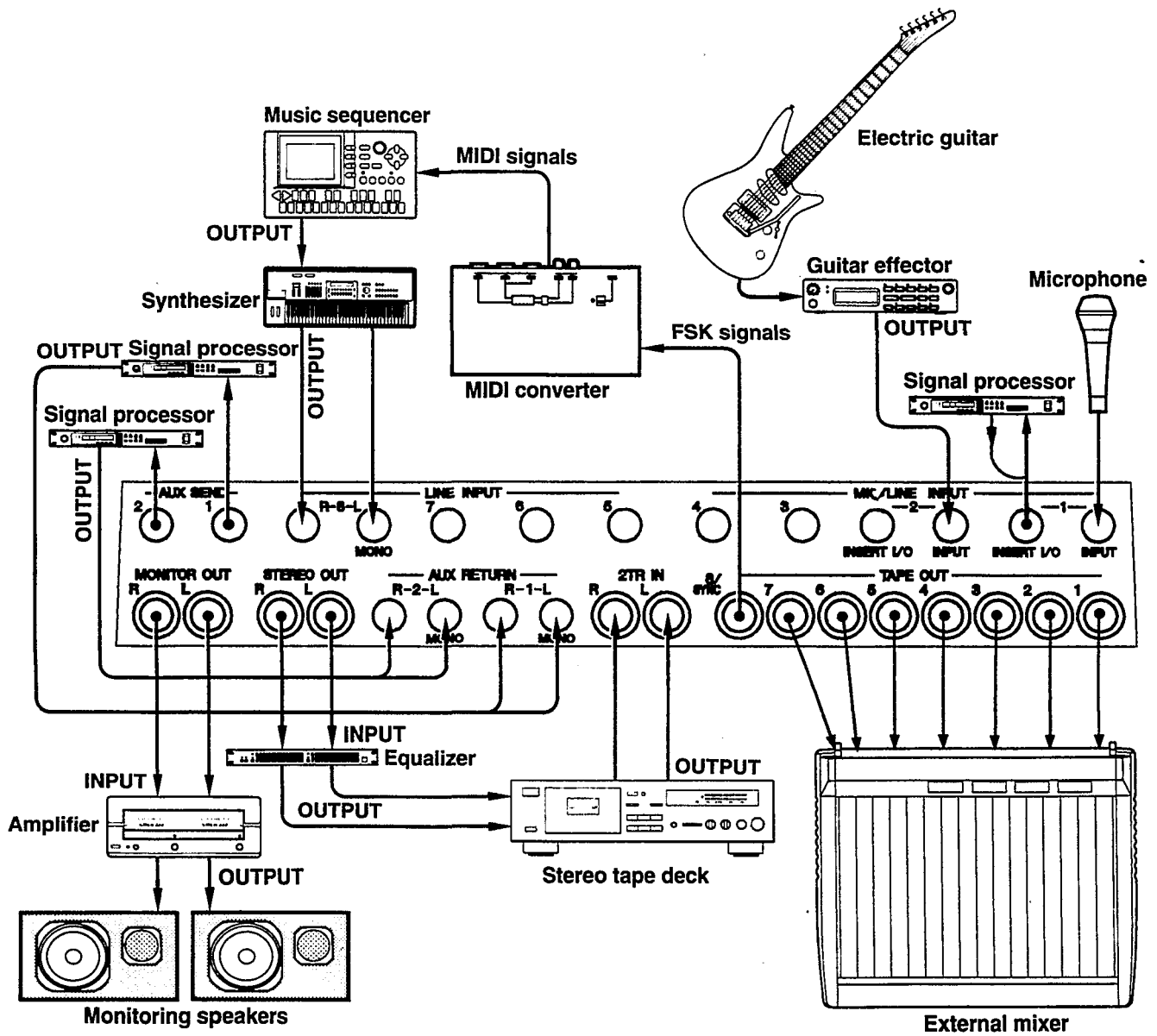

TROUBLESHOOTING

If this unit doesn't work properly, the reason will probably be that a small mistake was made in carrying out the operations given in this manual. Before calling for repairs, check the following.

Problem	Probable Cause	Remedy
Sound cannot be recorded onto a track.	The REC SELECT switch is set incorrectly.	Set the REC SELECT switch correctly.
	The setting of the ASSIGN switch(es) is incorrect.	Select "ODD" for odd-numbered tracks (1,3,5,7) to be recorded and "EVEN" for even-numbered tracks (2,4,6,8).
The sound of an instrument connected to one of the input jacks or the tape playback sound cannot be listened to or recorded.	The corresponding input selector switch is set incorrectly.	Set the input selector switch to the correct position.
The level at high frequency drops during playback. The playback level is too low.	The record/playback head is dirty.	Clean and demagnetize the head. Refer to "Maintenance" described below.
Excessive distortion and noise are heard during playback.	The recording level is set unproperly.	In recording, set the recording level properly while watching the level meter.
	The tape is set incorrectly.	Reset the tape correctly.
When an instrument is connected and played, the level meter does not rise to the proper level even though the channel fader is set to "10".	The output level of the connected instrument is too low.	Increase the output level of the instrument, or adjust the GAIN control for the channel which the instrument is connected to.
The unit does not operate when the POWER switch is turned on.	The power cord is not plugged incorrectly.	Plug the power cord correctly into the mains power supply or into the unit.
Signals are not properly synchronized during SYNC recording.	The SYNC switch is not pressed to be turned on.	Press the SYNC switch to be turned on, and the FSK signals should be recorded onto track 8.
	The level of the already-recorded FSK signals is too low.	Re-record the FSK signals.
	The level of the signals to be recorded on track 7 is too high.	Reduce the level of the signals or record the signals onto another track.

■ MAINTENANCE

If the recorder is used for a long period of time, the heads, pinch roller and capstan will become dirty and the heads will become magnetized. These can cause any of the following problems to occur.

- Recording, playback and erasure are not possible
- Sound level becomes low
- Fluctuating sound or signal dropout
- Excessive noise
- A drop in level at high frequencies

If these symptoms are observed, first try cleaning the recorder.

To make sure the head is always kept clean, it should be cleaned after every ten hours of use.

*Always clean the recorder before doing any important overdubbing and mixing.

• **Cleaning the Recorder**

Apply a few drops of head cleaning fluid or pure alcohol to the cotton swabs included with the recorder, or to any cotton swabs available on the market, and wipe the head, capstan, and pinch rollers.

• **Demagnetizing the Heads**

When the recorder is used over a long period of time, metallic sections and head sections which come in contact with the tape become magnetized, and this can cause deterioration of the characteristics. The head should be demagnetized using a head eraser (a demagnetizing unit) after every 20 to 30 hours of use.

To do this, please refer to the instruction manual that comes with the head eraser.

• **Raising the Head**

While holding down the **PLAY** button and **REC SELECT** switch 1, turn on the **POWER** switch and press the **PLAY** button again. The head can be lifted up even when there is no tape in the recorder and the **REMAIN** indicator flashes. The head should be in this position while being cleaned.

After the head has been cleaned, always press the **STOP** button and turn off the power supply to return the head to its original position. If the recorder is used with the head in the raised position, the button operations may not match the corresponding displays.

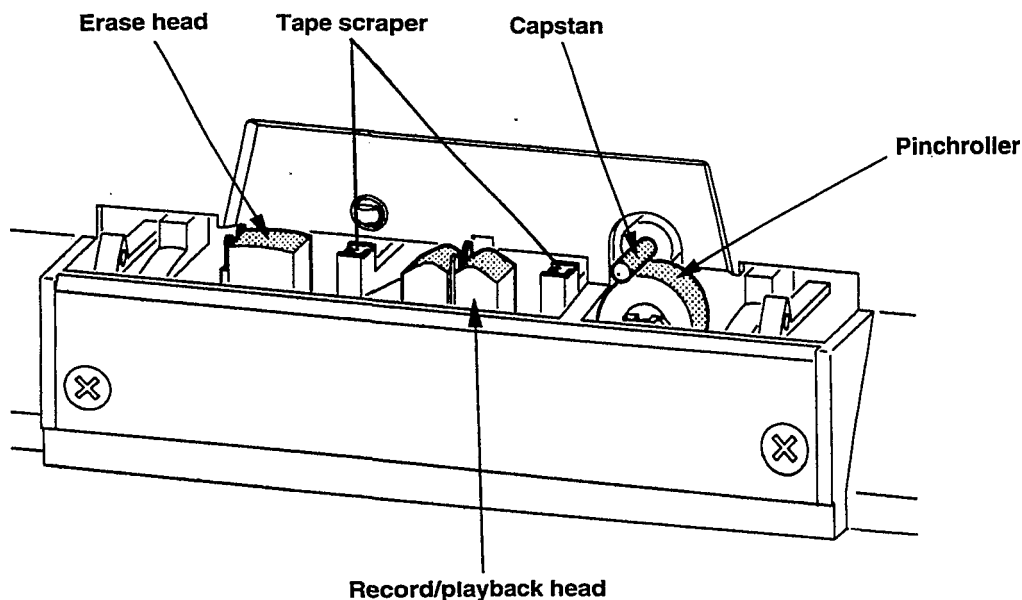

SPECIFICATIONS

■ GENERAL SPECIFICATIONS

MODEL 8-track/8-channel one way recording and playback cassette recorder with mixer

TAPE TRANSPORT	Tape Type	CrO ₂ (Bias: HIGH; EQ: 70 μs)
	Track Configuration	8-track/8-channel one way recording and playback
	Heads	8-channel Permalloy rec/play head x 1 8-channel ferrite erase head x 1
	Motor	DC servo motor for capstan x 1 DC motor for reel x 1 DC motor for mechanism control x 1
	Tape Speed	9.5 cm/sec.
	Pitch Control	Approx. ±12%
	Wow & Flutter	0.08% WRMS or less
Rewind Time	Approx. 95 sec. at normal speed (for C-60 tape) Approx. 75 sec. at high speed (for C-60 tape)	

ELECTRICAL SPECIFICATIONS: 0 dB = 0.775 Vr.m.s.

<No. of I/O Jacks>

MIC/LINE x 4 CH1 - 4	INSERT I/O x 2 CH1 - 2	LINE x 3 CH5 - 7
LINE L/MONO, R x 1 CH8	AUX RETURN L/MONO, R x 2	2TR IN L, R x 1
AUX SEND x 2	STEREO OUT L,R x 1	MONITOR OUT L, R x 1
TAPE OUT x 8 CH1 - 8	PHONES L,R x 1	

CONNECTORS

MIC/LINE 1 - 4	Input Impedance 10kΩ Min. Input Level -56 dB (gain control, ch. fader max.) Max. Input Level +10 dB (gain control min., headroom margin)	Rated Input Level -10 dB to -50 dB (ch. fader nominal)
INSERT IN 1, 2	Input Impedance 10kΩ Min. Input Level -16 dB (ch. fader max.)	Rated Input Level -10 dB
LINE 5-8	Input Impedance 10kΩ Min. Input Level -16 dB (ch. fader max.)	Rated Input Level -10 dB (ch. fader nominal)
AUX RETURN L/R 1, 2	Input Impedance 20 kΩ Min. Input Level -16 dB (AUX RTN LEVEL control max.)	Rated Input Level -10 dB (AUX RTN LEVEL control nominal)
2TR IN L, R	Input Impedance 10kΩ Min. Input Level -16 dB	Rated Input Level -10 dB (MONITOR/PHONES control nominal)
INSERT OUT 1, 2	Output Impedance 100 Ω Rated Output Level -10 dB (at 10 kΩ load)	Rated Load Impedance 10 kΩ or more
AUX SEND 1, 2	Output Impedance 1 kΩ Rated Output Level -10 dB (at 10 kΩ load)	Rated Load Impedance 10 kΩ or more
STEREO OUT L, R	Output Impedance 1 kΩ Rated Output Level -10 dB (at 10 kΩ load)	Rated Load Impedance 10 kΩ or more
MONITOR OUT L, R	Output Impedance 1 kΩ Rated Output Level -10 dB (at 10 kΩ load)	Rated Load Impedance 10 kΩ or more
TAPE OUT 1 - 8	Output Impedance 100 Ω Rated Output Level -10 dB (at 10 kΩ load)	Rated Load Impedance 10 kΩ or more
PHONES	Rated Load Impedance 8-40 Ω	Max. Output Level 100 mW (at 40 Ω load)

MIXER

Frequency Response (At Rated Input and Output)

20 Hz-20 kHz ± 1 dB
 -4

MIC IN-STEREO OUT
LINE IN-STEREO OUT
LINE IN-PHONES OUT

Noise level (12.7 kHz: 6 dB/oct. L.P.F)

Signal process noise: -115 dB/Rs=150 Ω

STEREO OUT: -80 dB/CH, optimum position of the Master Fader

S/N Ratio (At Rated Input and Output Levels)

68 dB/IHF-A MIC IN-STEREO OUT (GAIN TRIM MAX.)

70 dB/IHF-A LINE IN-STEREO OUT (GAIN TRIM MIN.)

Distortion (1 kHz, At Rated Input and Output)

0.3 %/30 kHz L.P.F MIC IN-STEREO OUT (GAIN TRIM MAX.)

0.05 %/30 kHz L.P.F LINE IN-STEREO OUT (GAIN TRIM MIN.)

Equalizer

LOW/SHELVING

Standard Frequency 100 Hz

Variable Range ± 12 dB

MID/PEAKING

Standard Frequency 1 kHz

Variable Range ± 12 dB

HIGH/SHELVING

Standard Frequency 10 kHz

Variable Range ± 12 dB

RECORDER

(4 track simultaneous recording)

Overall Frequency Response

50 Hz-14 kHz ± 3 dB (dbx NR OFF)

Overall S/N ratio

80 dB/IHA-F (dbx NR ON), (At distortion level of 3 %)

Overall Distortion

2% (400 Hz, -10 dB)

Overall channel separation
(between adjacent channels)

60 dB (1 kHz, -10 dB, dbx NR ON)

Erasure Rate

55 dB (1 kHz, 0 dB)

Noise Reduction

dbx NR (SYNC position: TR8 = OFF)

GENERAL

Control Jacks

PUNCH I/O (FC4 or FC5)

REMOTE CONTROL (RCM1)

Power Requirements

U.S. & Canadian Models: 120 V AC, 60 Hz

UK Model: 240 V AC, 50 Hz

General Model: 230 V AC, 50 Hz

Power Consumption

40 W

Dimensions (WxHxD)

489 mm X 129 mm X 390 mm (19 - 1/4" X 5 - 1/16" X 15 - 3/8")

Weight

7.0kg (15 lbs. 6oz.)

Accessory

AC power cord, cotton swab

* dbx is a trademark of dbx Incorporated.

0 dB = 0.775 Vr.m.s.

All specifications subject to change without notice.

DIMENSIONS

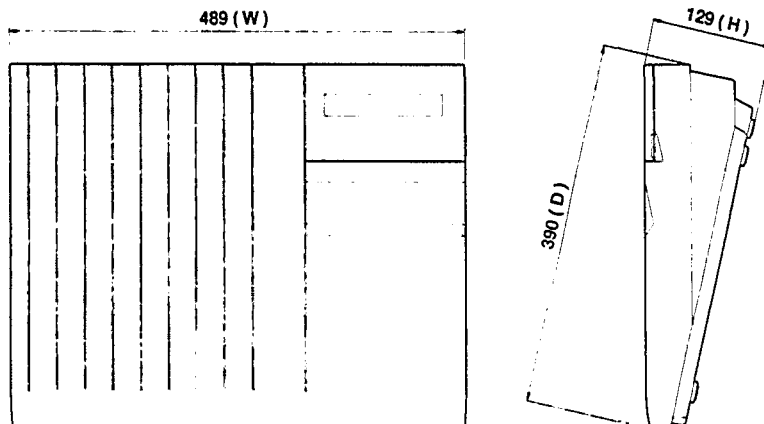

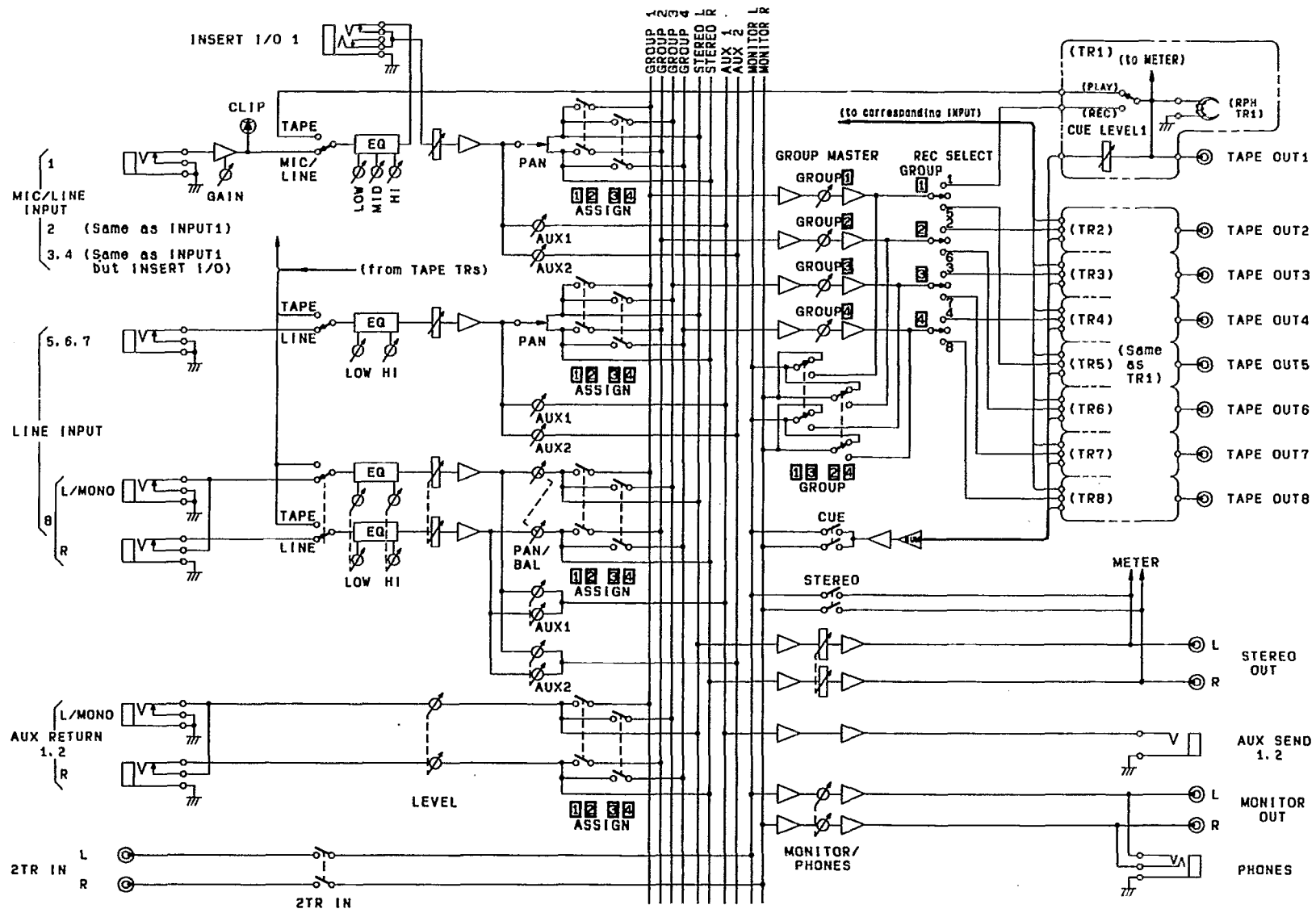

■ BLOCK DIAGRAM

TRACK SHEET



TITLE _____

DATE - - _____

ARTIST _____

COMPOSER _____

ENGINEER _____

ARRANGER _____

1	2	3	4	5	6	7	8

1	2	3	4	5	6	7	8

1	2	3	4	5	6	7	8

1	2	3	4	5	6	7	8

1	2	3	4	5	6	7	8

YAMAHA

MT8X OM
10/20/98 98056

YAMAHA®

Yamaha Corporation of America
6600 Orangethorpe Avenue, P.O. Box 6600, Buena Park, CA 90622-6600



MT8X OM



Recyclable



Recycled